

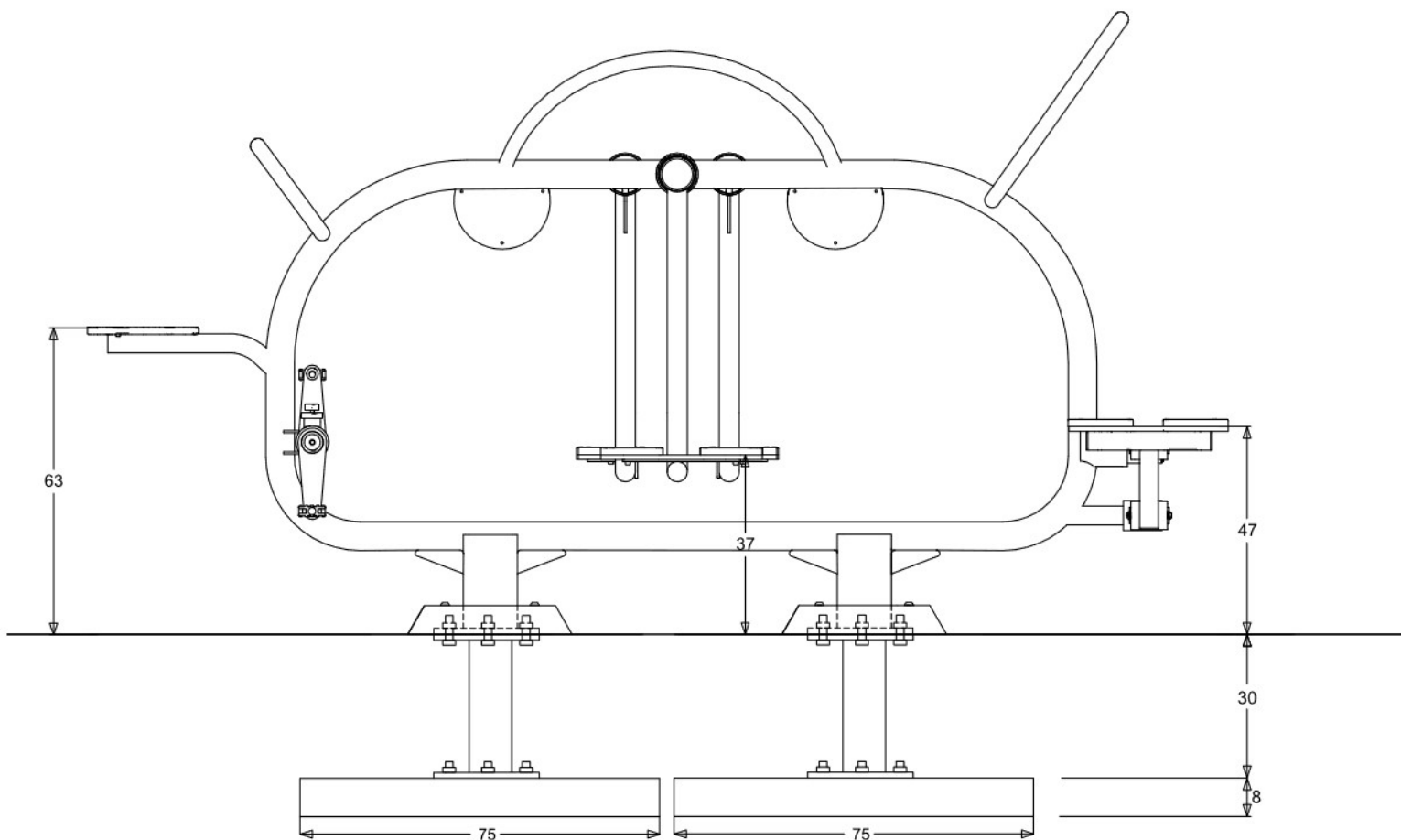











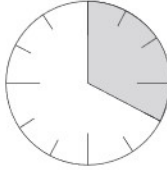

Footing plan
Plan fundamentowania
Implanation
Implanación
Fundamentplan

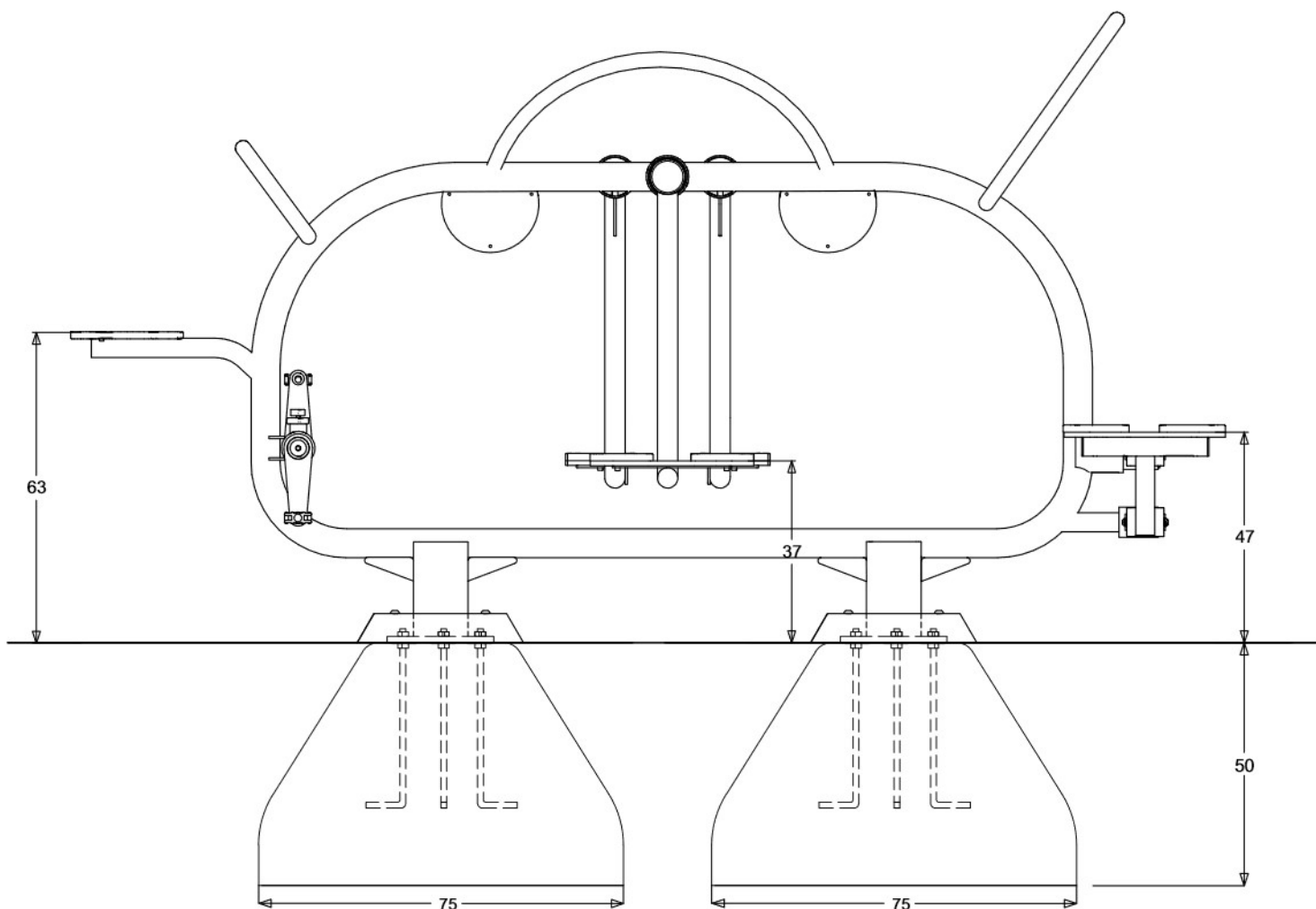

8xM16 	8xM16 	 24 	2x 		 Min. 48h
---	---	---	--	---	--

Footing plan
Plan fundamentowania
Implanation
Implanación
Fundamentplan

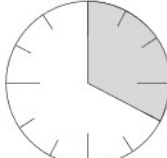
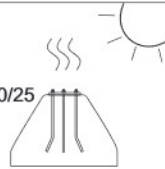

8xM16 	8xM16 	 24 	2x 		 Min. 0h
---	---	---	--	---	---