

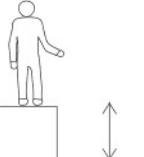

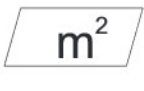

Installation manual  
Instrukcja instalacji  
Manuel d'installation  
Manuale di installazione  
Installationshandbuch

		
1,2 m	24 m <sup>2</sup>	14 → +



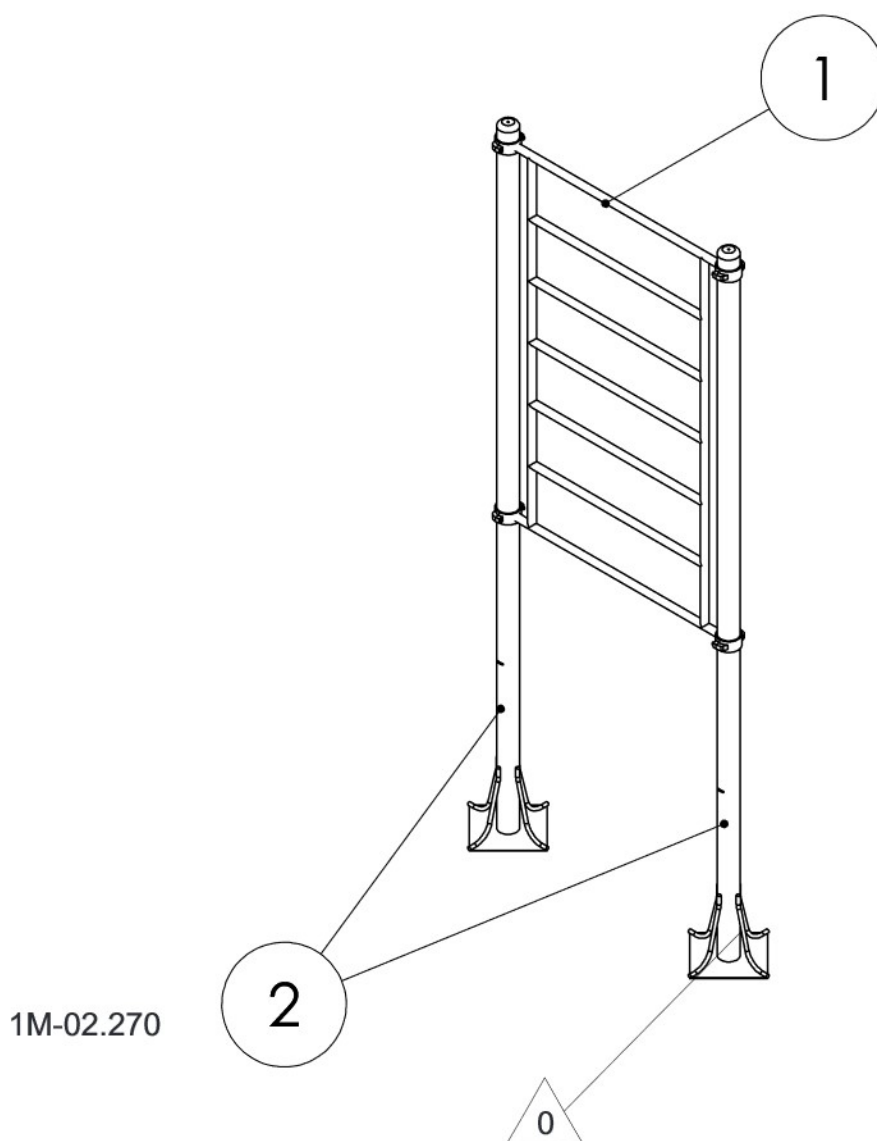





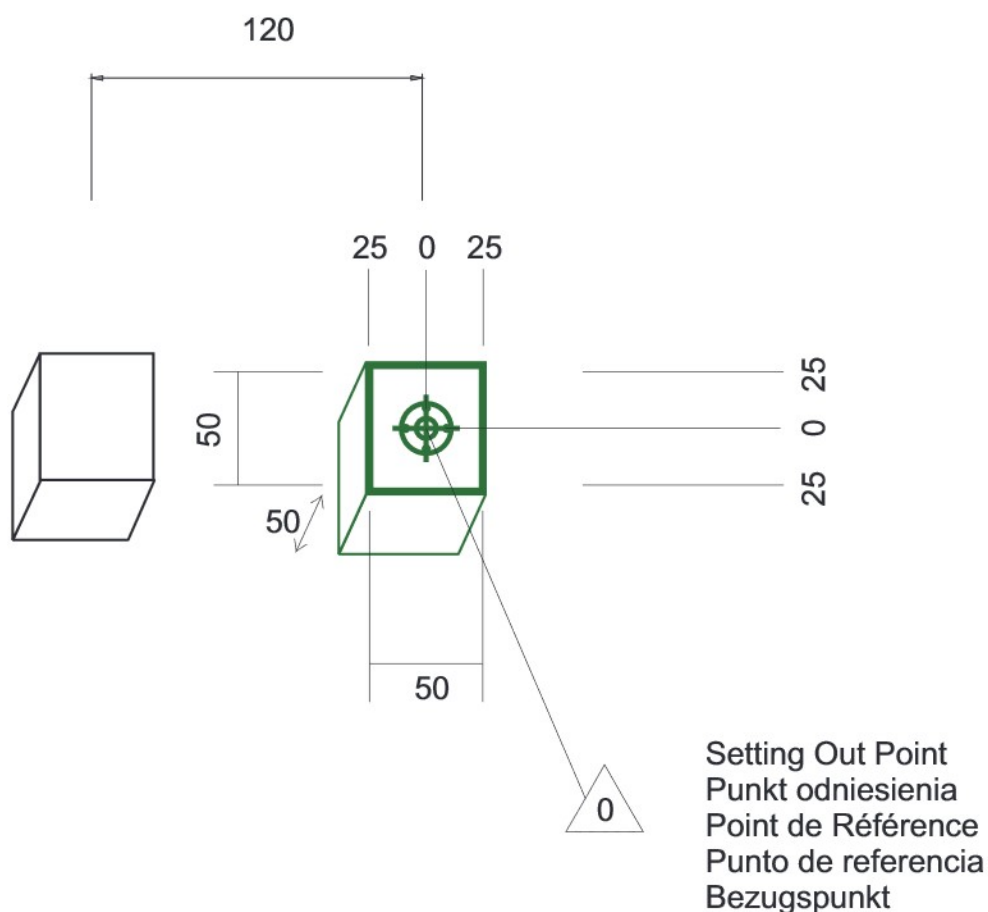

Concrete pad   
Fundament betonowy  
Dalle béton  
Solera de Hormigón  
Beton Bodenplatte

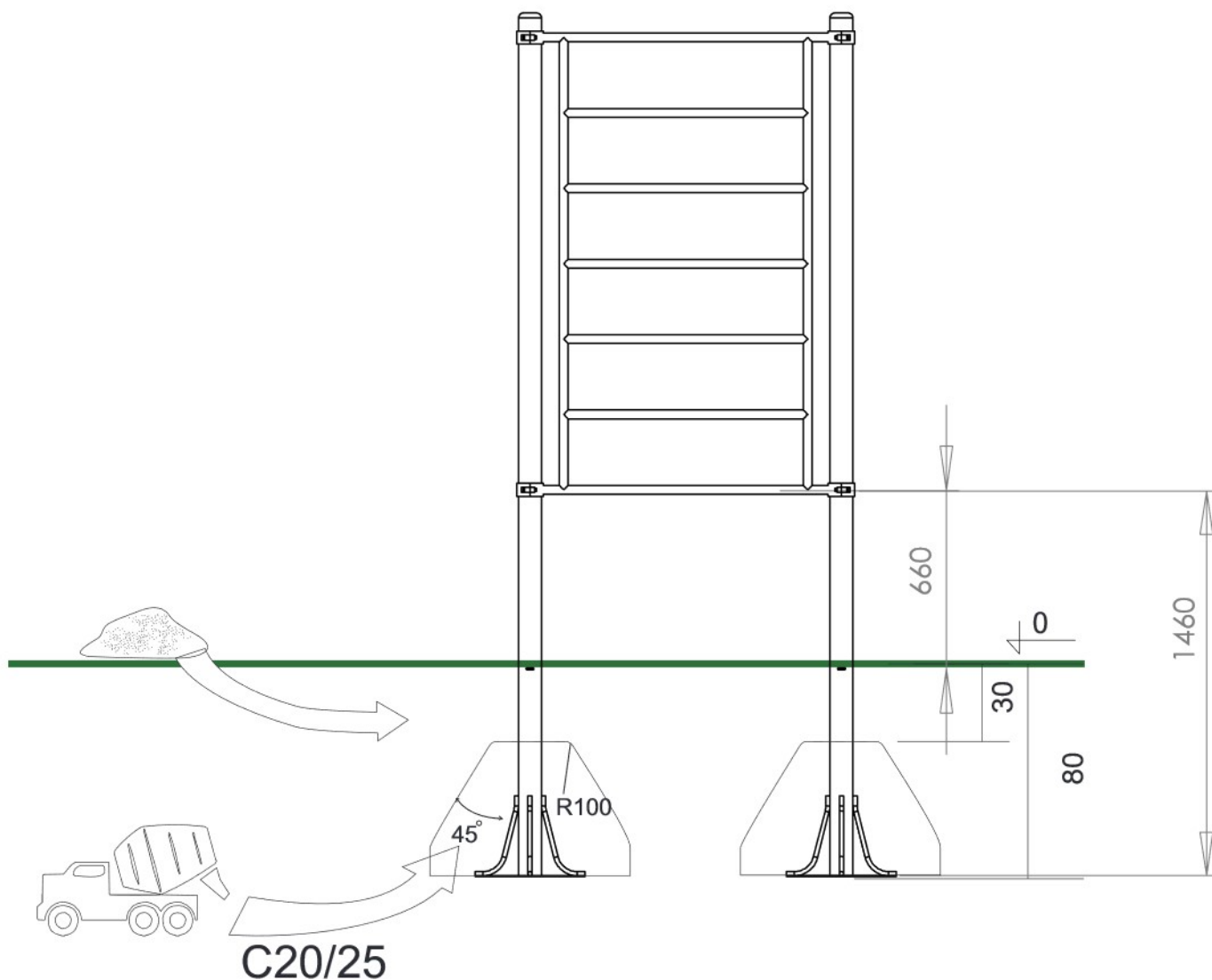
$0,5 \text{ m}^2 / 0,25 \text{ m}^3$



Footing plan  
 Plan fundamentowania  
 Implanation  
 Implanación  
 Fundamentplan

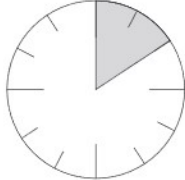

<b>16xM12x35</b> <b>DIN 912</b> 	<b>16xM12</b> <b>DIN 1587</b> 	<b>16xM16</b> 	 <b>24</b> 	<b>2x</b> 	
--	---	--	--	--	---