

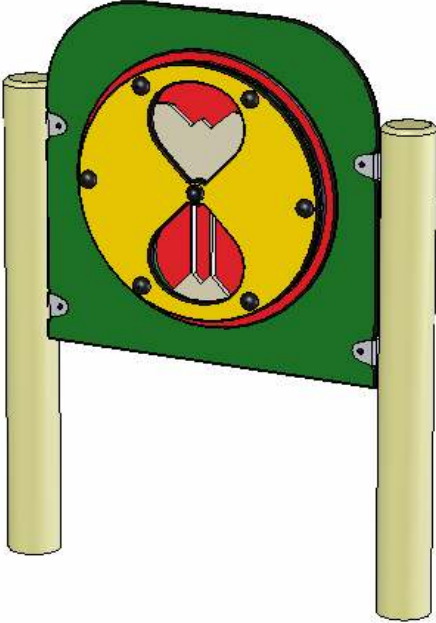









INSTALLATION INSTRUCTION		Trail Timer		Ref No. ITR/4	Iss No. 01
Check all parts are present to list below				Final Assembly of Unit / Module	
Part	Qty	Image	Description		
ITR04	2		Vertical Pole		
ITR03X1	1		Trail Timer Assembly		
BR10	4		Steel Bracket		
F002	4		M10 x 30mm Coach Bolt		
F070	4		M10 x 50mm Security Coach		
F110	4		M10 Washer 21mm O/D		
F137	4		M10 Nylock Nut		
F601A	4		Plastic Dome Cap Washer		
F601B	4		Plastic Dome Cap		
F603	4		Plastic Washer		
				Dimensions	
				Overall Dimensions:	0.8m 0.2m 1.2m
				Construction Space:	3.2m 2.6m 2.4m
				Note: Recommended Max. Fall of Finished Ground = 1 in 20	
				Hole details on various surface types	
				Ground Plan (mm)	Width Length Depth
				Synthetic Surfacing:	300 300 580 A
				Existing Turf:	300 300 600 B
				Loose-fill (300mm):	300 300 400 C
				Loose-fill (150mm):	300 300 500 C
				Note: Refer to General Foundation Details.	

Playdale

GROUND PLAN

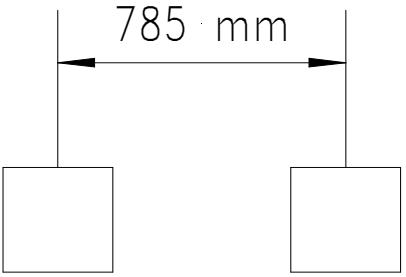

- NOTES:**
 Before commencing ensure 'General Installation Guidance for Playdale Product' (INGEN) has been read and understood.
1. Dig footing holes as shown on ground plan.
 2. Place stone binding in the bottom of the holes to rectify ground hole depth.
 3. Sort and identify parts and check to list.

4. Using Fixing Method 03, fix brackets [BR10] to trail timer assembly [ITR03X1] with M10 x 30mm coach bolts. Ensure bracket and cap assemblies are on the same side as the timer.

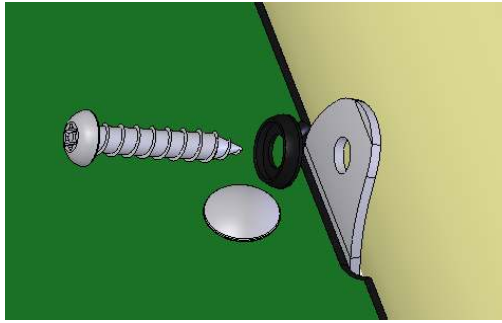
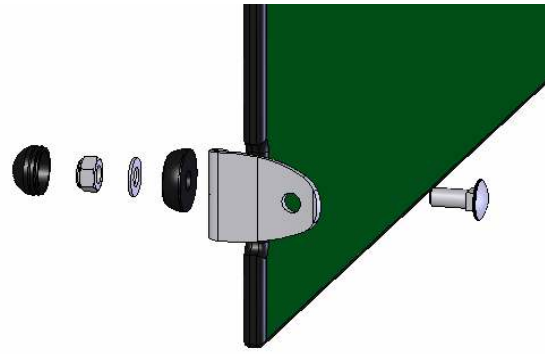

5. Align timer assembly [ITR03X1] between the vertical poles [ITR04]. Using Fixing Method 05 fix vertical poles to panel 180mm from top of pole to top of panel with M10 x 50mm security coach screws.

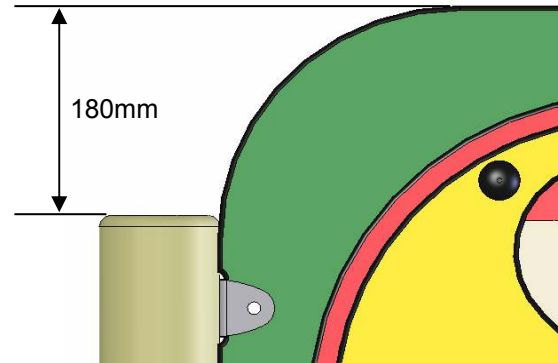

6. Place unit in footing holes, level and plumb. Temporary bracing will help keep the unit plumb until the concrete has set.

7. Fix in ground with concrete. Important: Refer to General Foundation Details (Inst Gen) for detail on concrete foundations.

Once the unit is fully installed it is important that all timber poles are fully checked for splinters and sharp edges and that these are removed.