

1

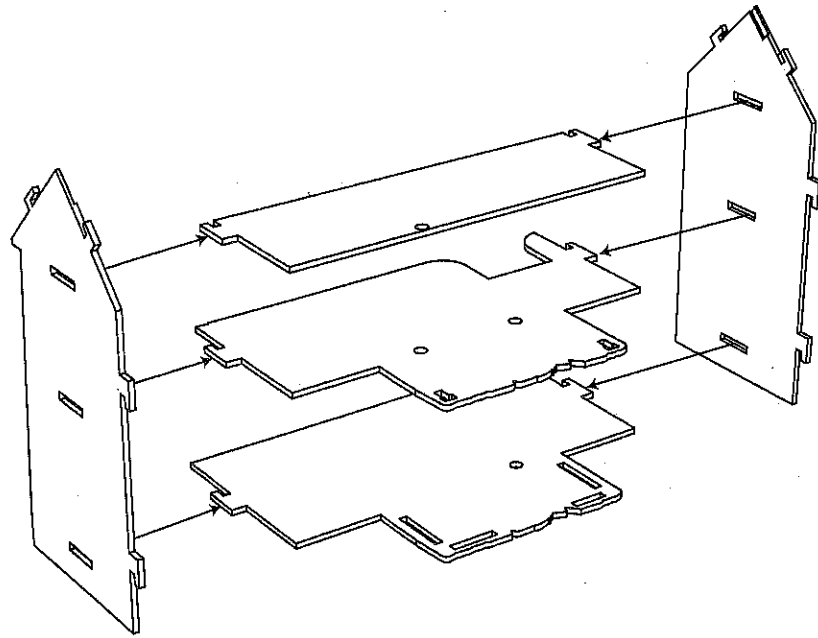

2

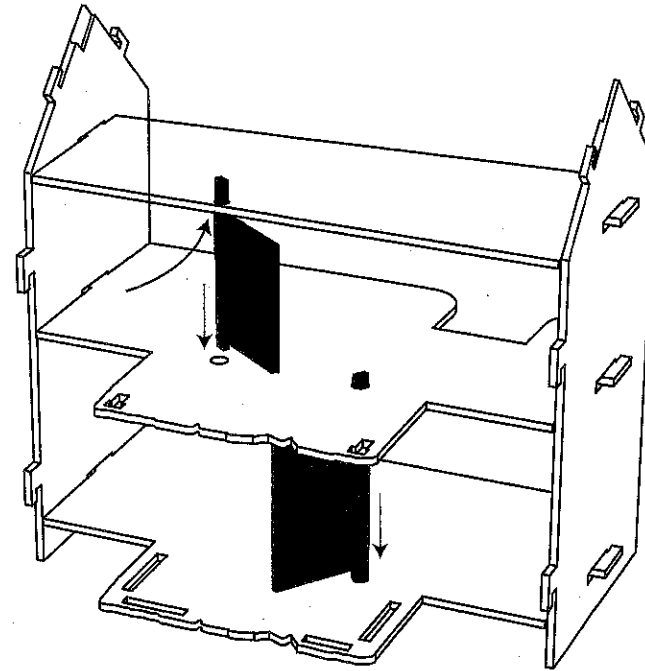

3

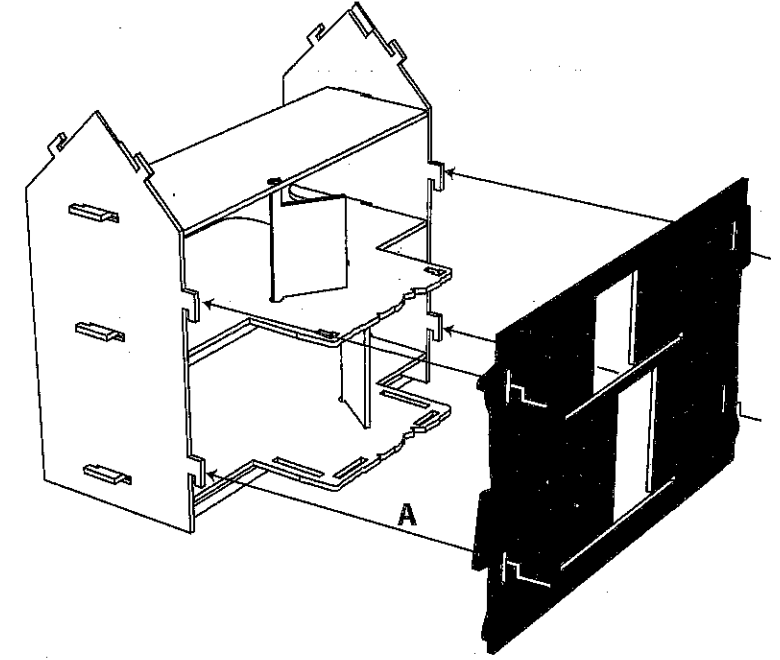

4

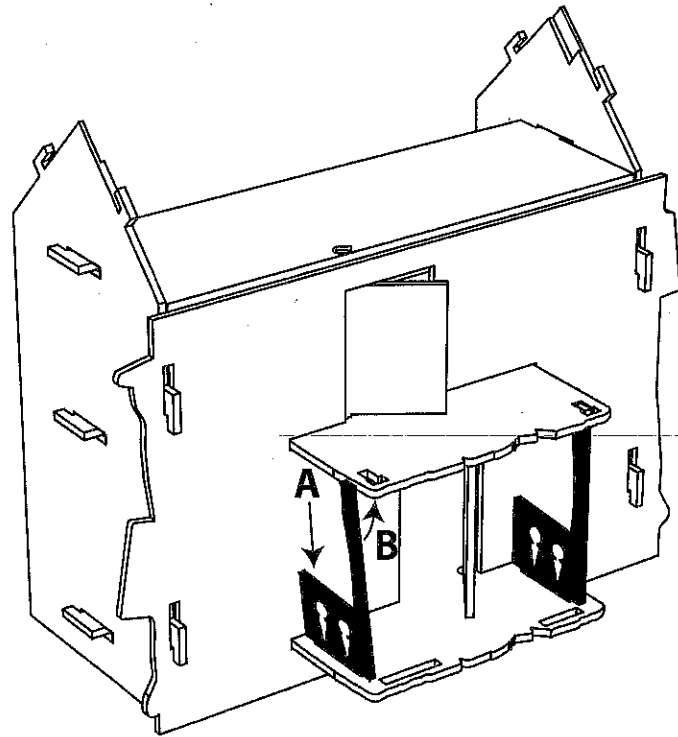

5

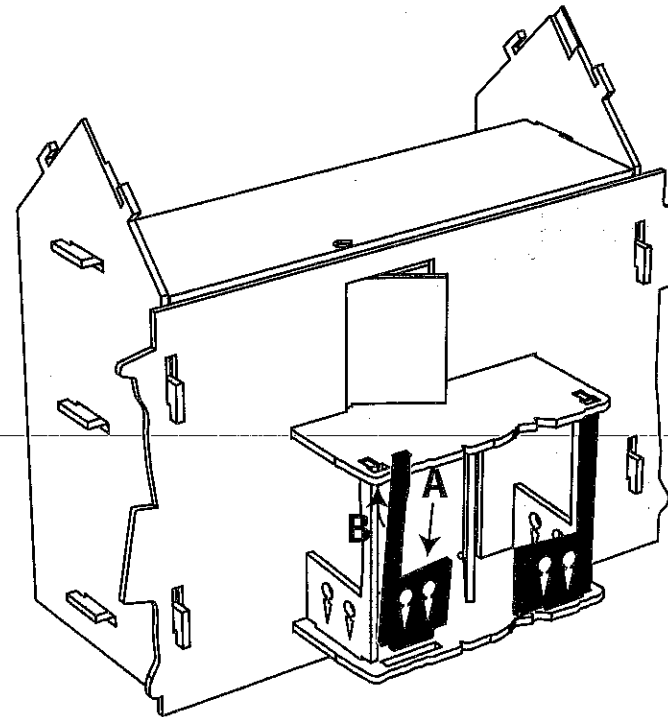

6

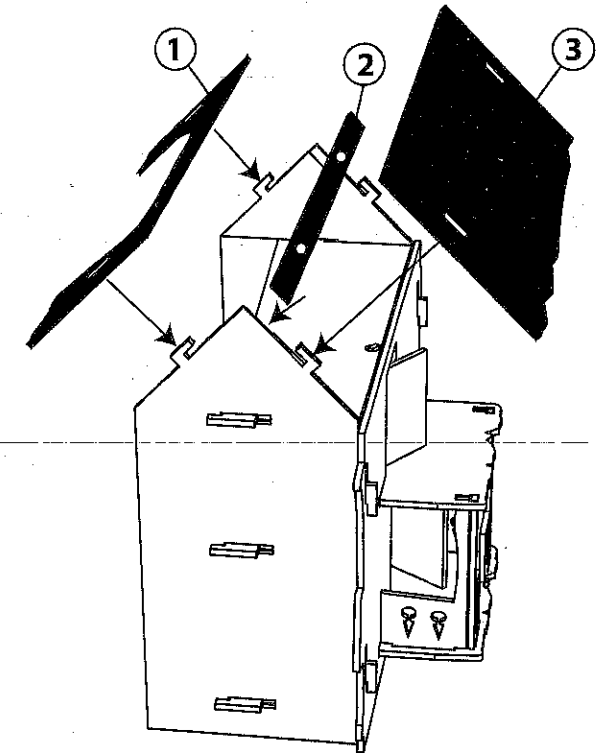

7

8

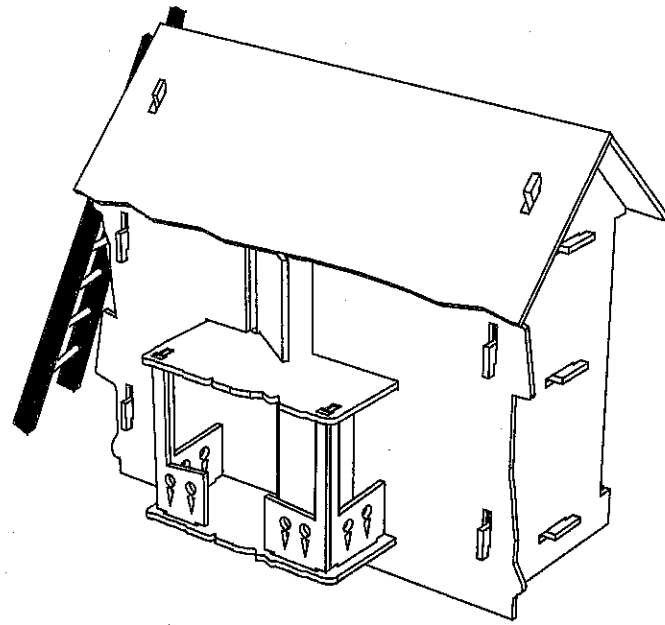
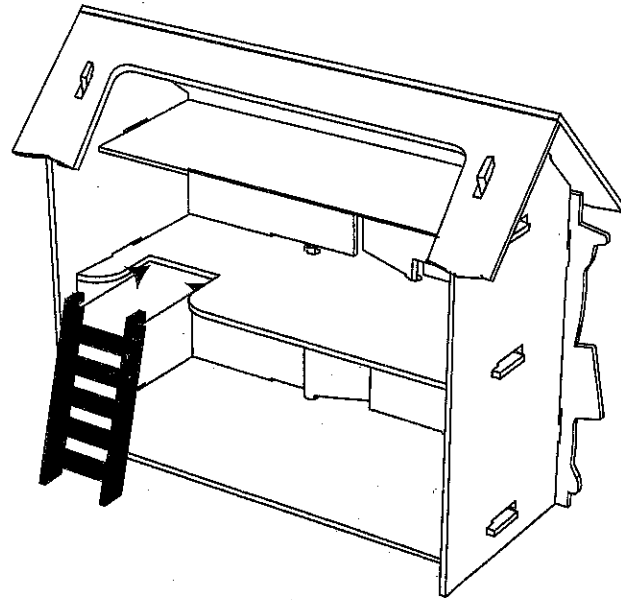

Disassemble

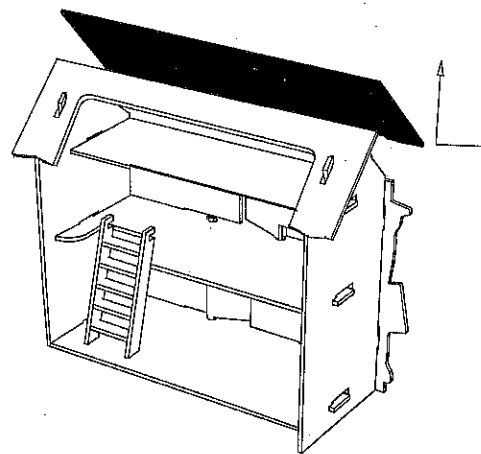
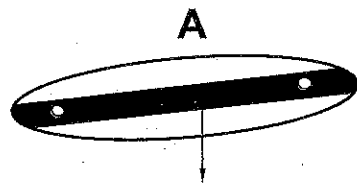
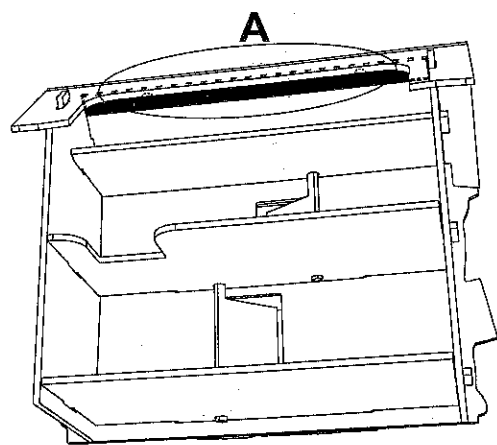

44.3753 PIPPI HOUSE WITH PLAYMAT

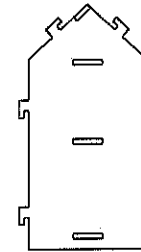

44.3753.01

X1



44.3753.02

X1

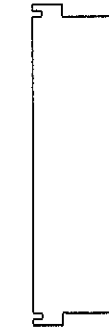

44.3753.03

X1

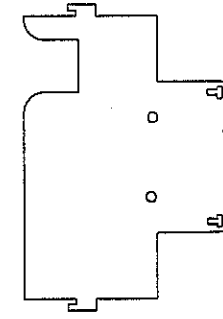

44.3753.04

X1

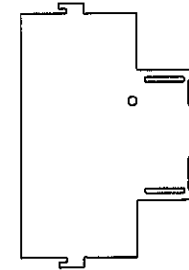

44.3753.05

X1

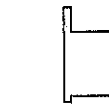

44.3753.06

X1



44.3753.07

X1

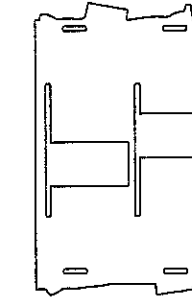

44.3753.08

X1

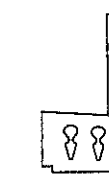

44.3753.09

X2

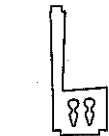

44.3753.10

X1

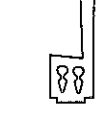

44.3753.11

X1

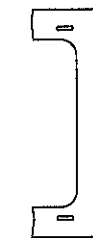

44.3753.12

X1



44.3753.13

X1



44.3753.14

X1



44.3753.15

X1

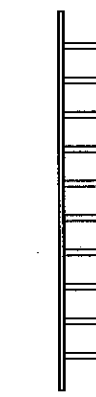

44.3753.16

X1



Head Office, Sweden: Micki Leksaker AB Industrivägen 7 SE-360 32 Gemla
Phone +46(0) 470 70 41 50 Fax +46(0) 470 673 15 E-mail: info@micki.se www.micki.se