

lekolar®

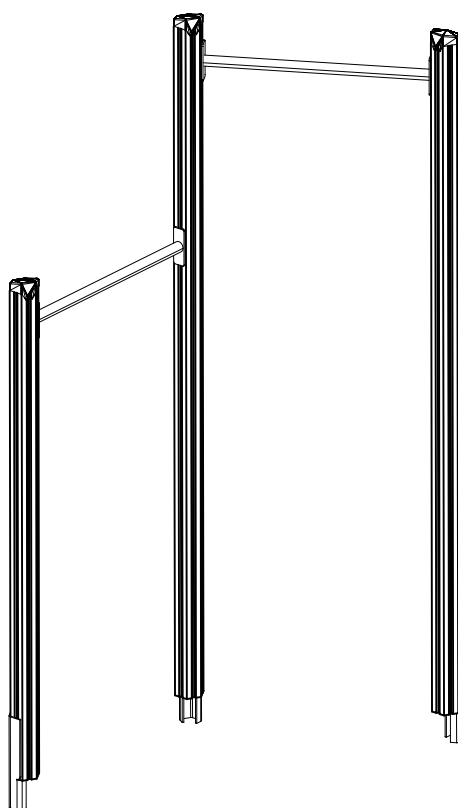





A SENNUSOHJE
MONTERINGSANSVISNING
INSTALLATION INSTRUCTION
AUFBAUANLEITUNG
NOTICE D'INSTALLATION

DATE: 5.10.2016

LEK1105

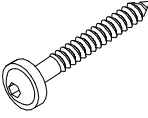
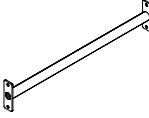

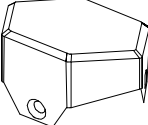
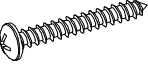
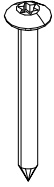
DATE: 5.10.2016

707827-620	PCS	707828-620	PCS	900240	PCS	907694-216	PCS	908399	PCS	908428	PCS
	1		2		12		2		3		3
90x80x1600		90x80x2200		Ø8x70		L 704		L=850		50x90x80	
980106	PCS	980123	PCS	708060	PCS						
	9		8		1						
Ø5x40		Ø7x60		90x50							
	PCS		PCS		PCS		PCS		PCS		PCS
	PCS		PCS		PCS		PCS		PCS		PCS
	PCS		PCS		PCS		PCS		PCS		PCS
	PCS		PCS		PCS		PCS		PCS		PCS

EN/AS Impact Area 11.6 m²

Falling Space 37 m²

Max Falling Height 2200 mm

Grid size = 1000 mm

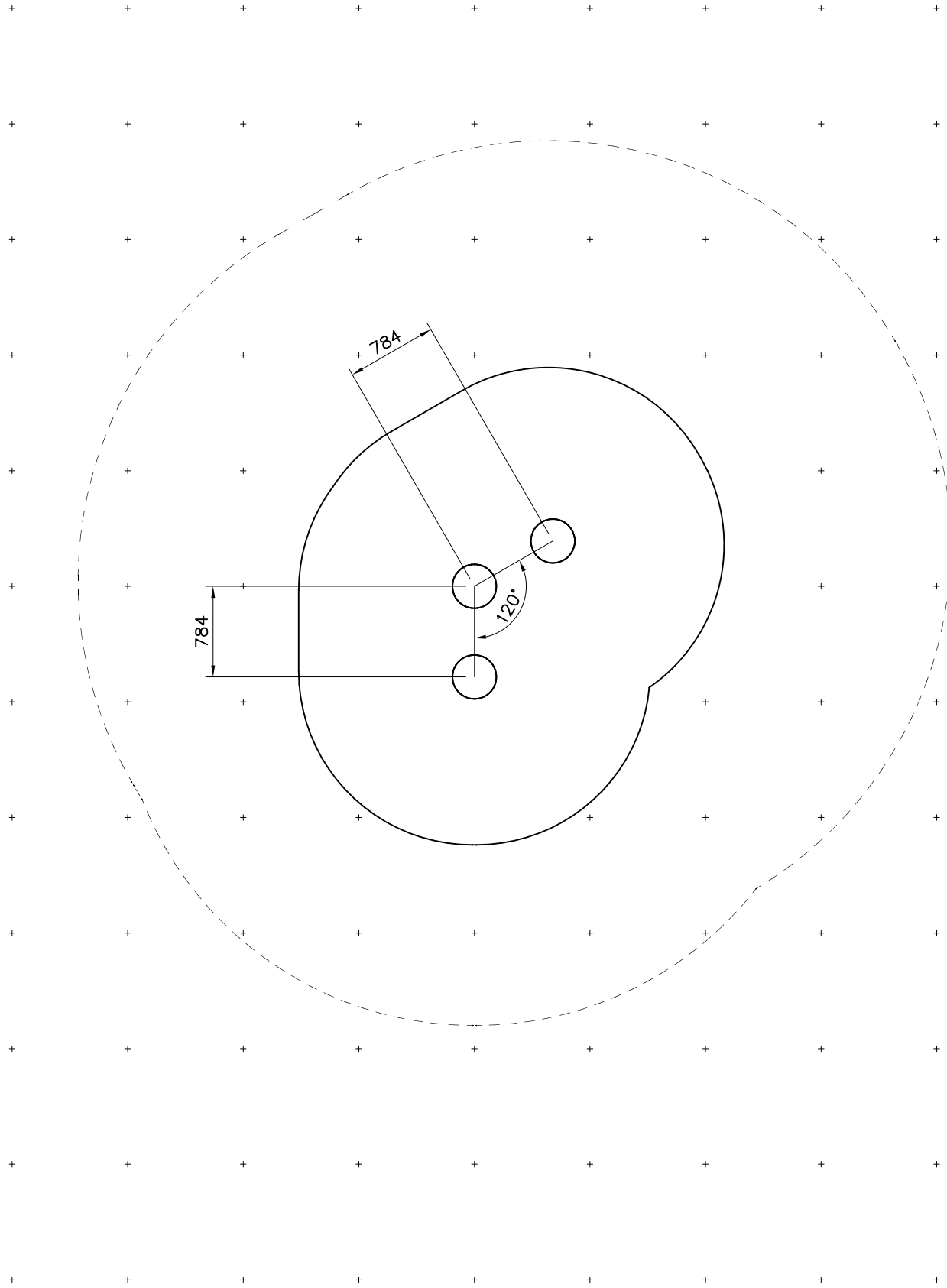
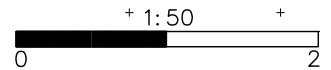

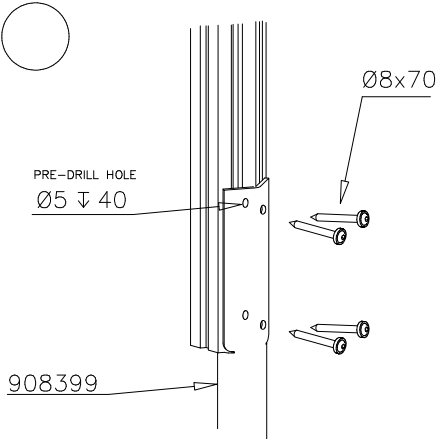
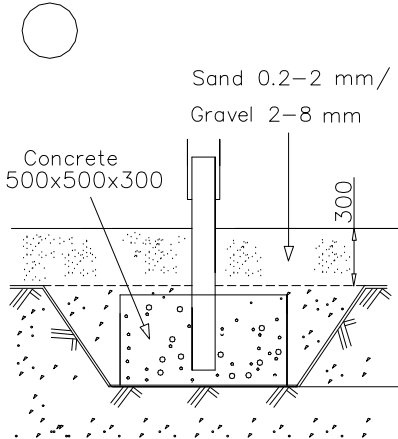
 <p>PRE-DRILL HOLE Ø5 ∇ 40</p> <p>Ø8x70</p> <p>908399</p>	 <p>Sand 0.2-2 mm/ Gravel 2-8 mm</p> <p>Concrete 500x500x300</p> <p>300</p>	

EN/AS Impact Area 11.6 m²

Falling Space 37 m²

Max Falling Height 2200 mm

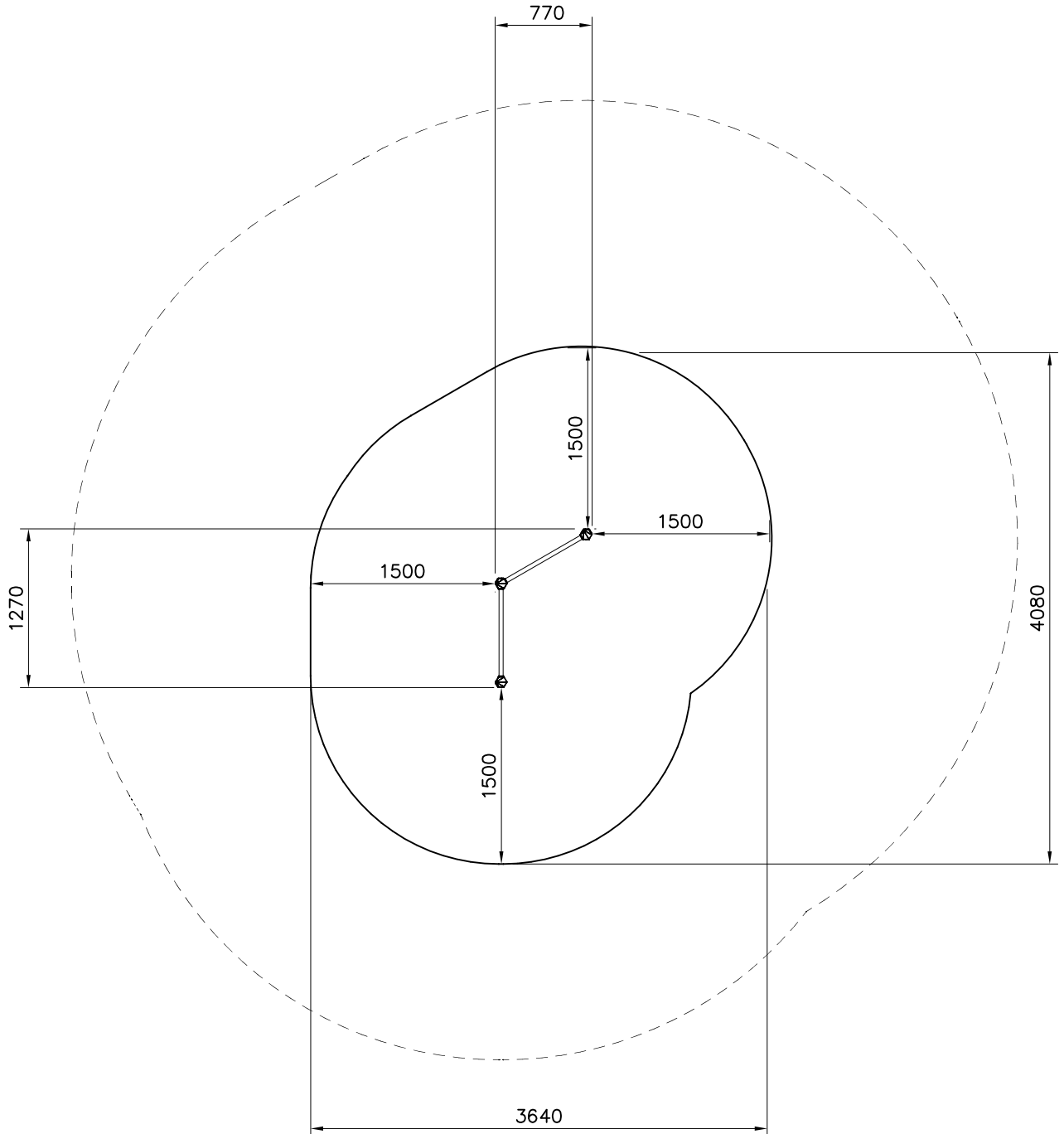
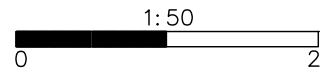

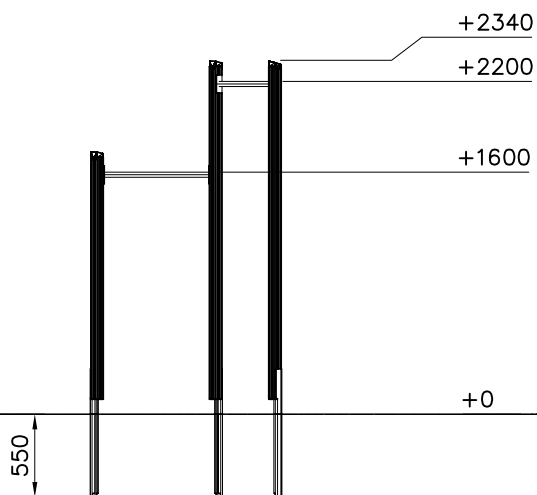
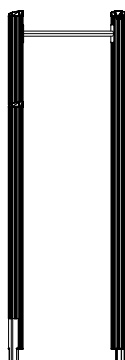

DET 1	DET 2	DET 3	
