

ST 0511

R1R3

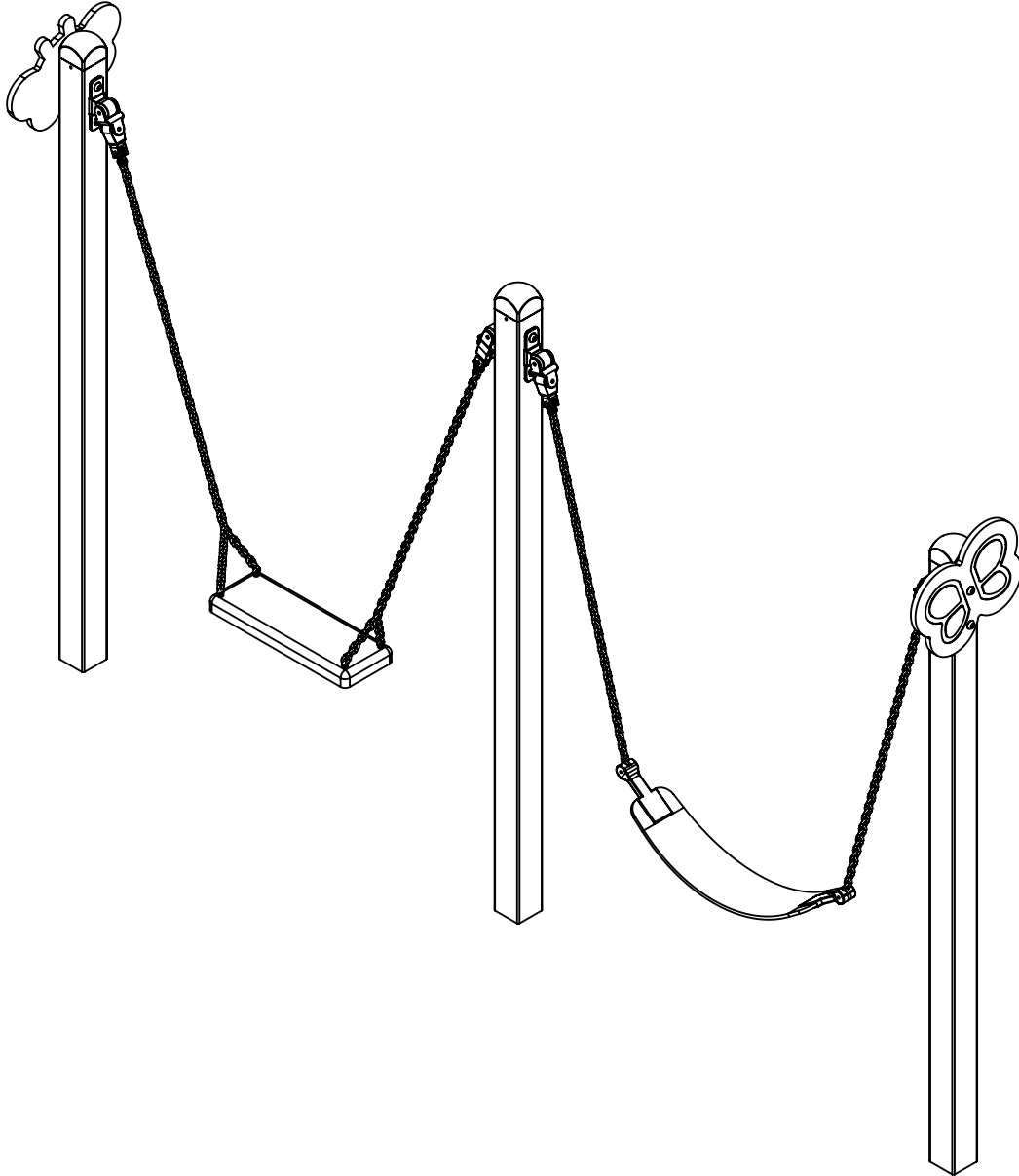

[cm]
v010
01.04.19
V. D.

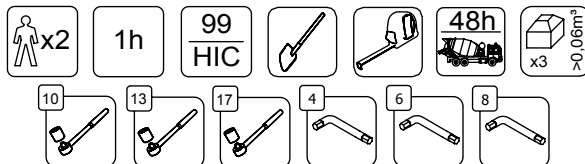

play
vinici

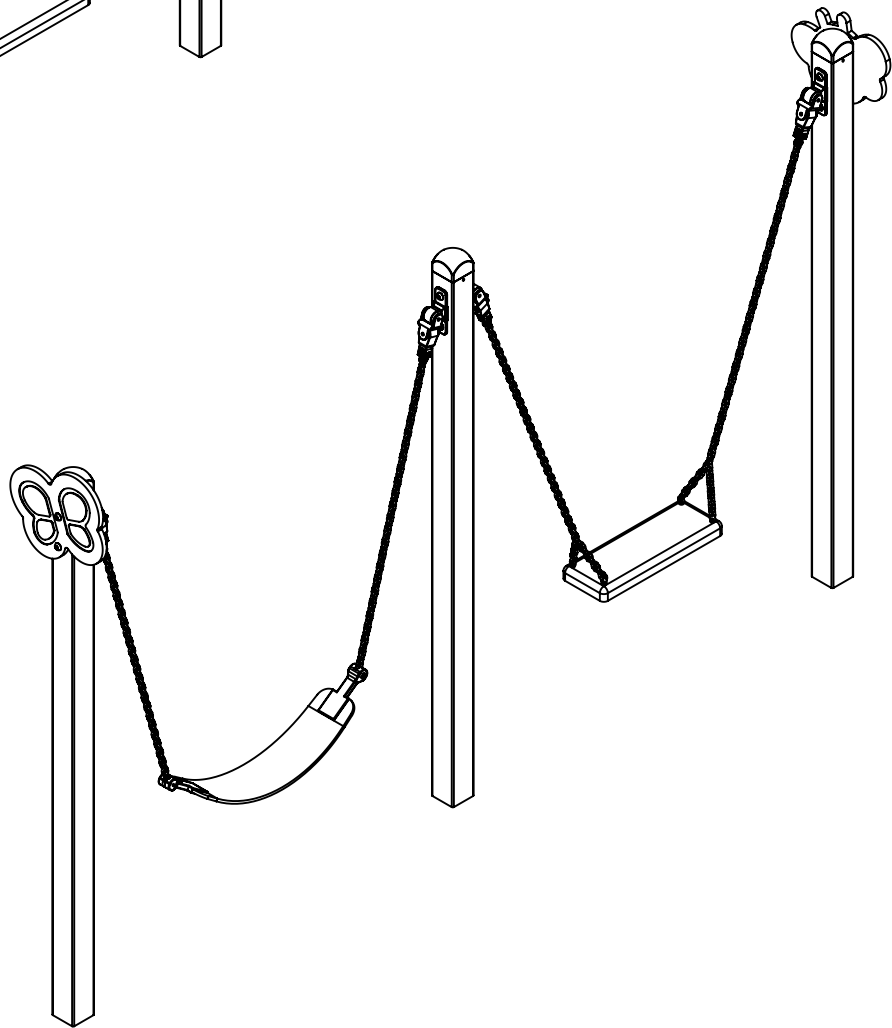
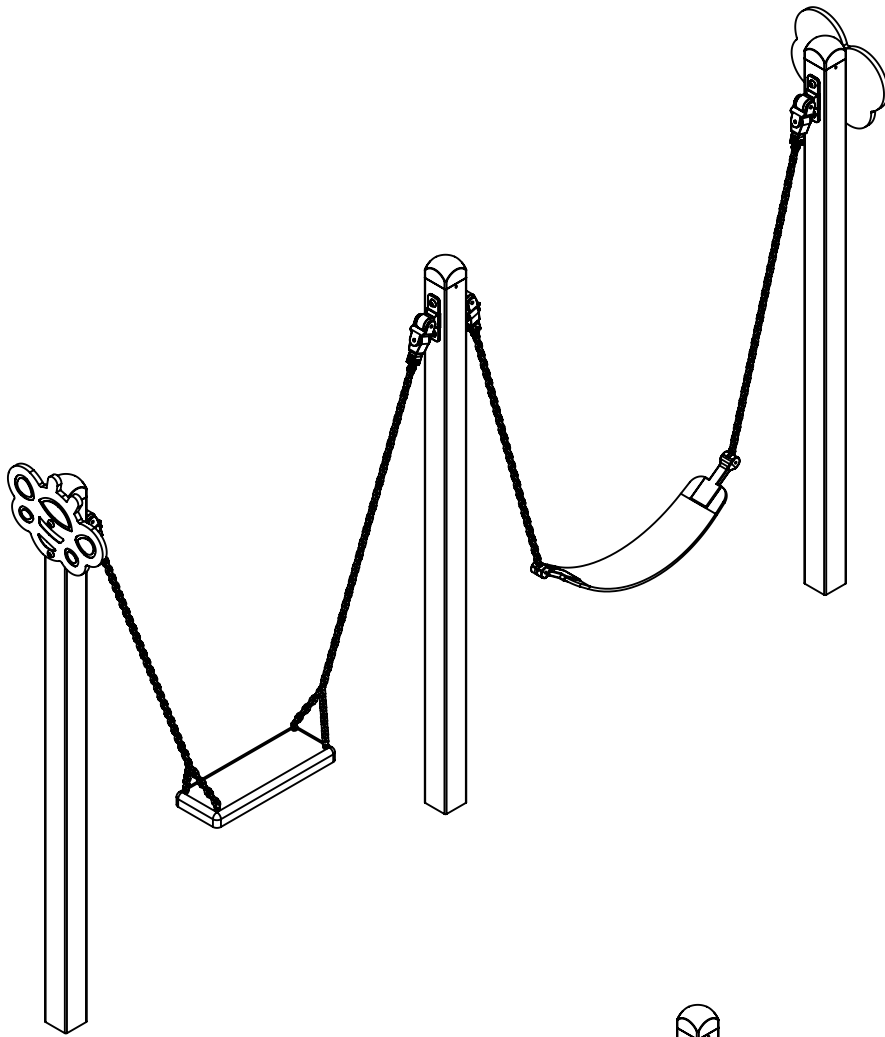

[cm]

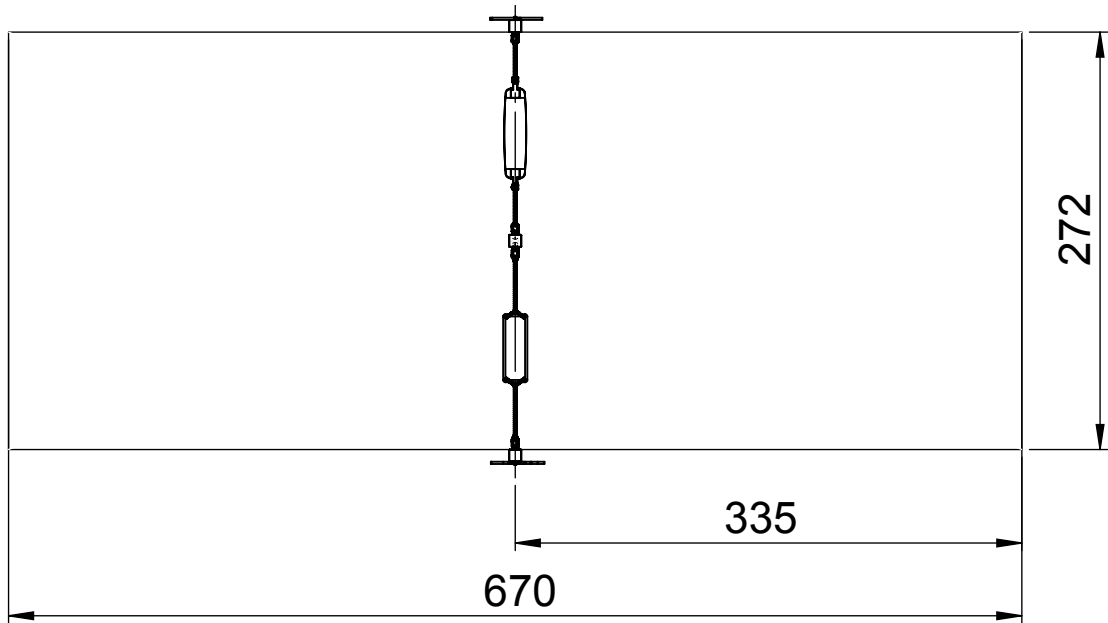
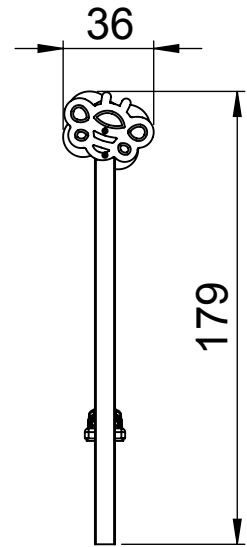
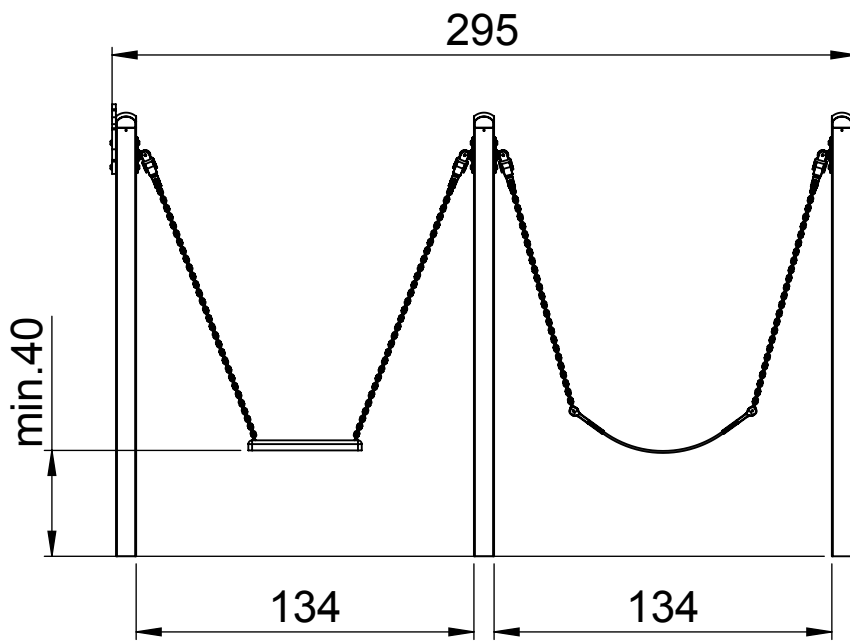

[cm]



play
Vinci

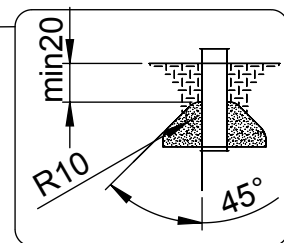
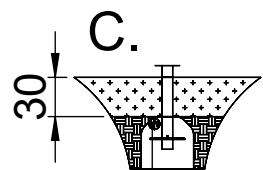
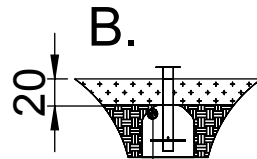
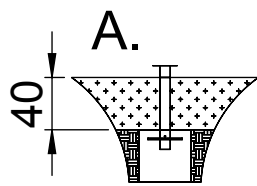
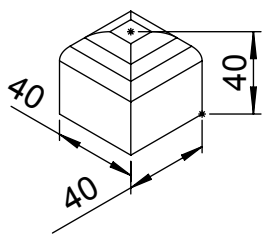
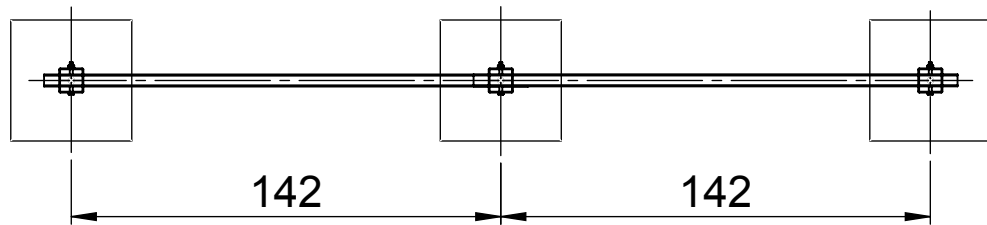
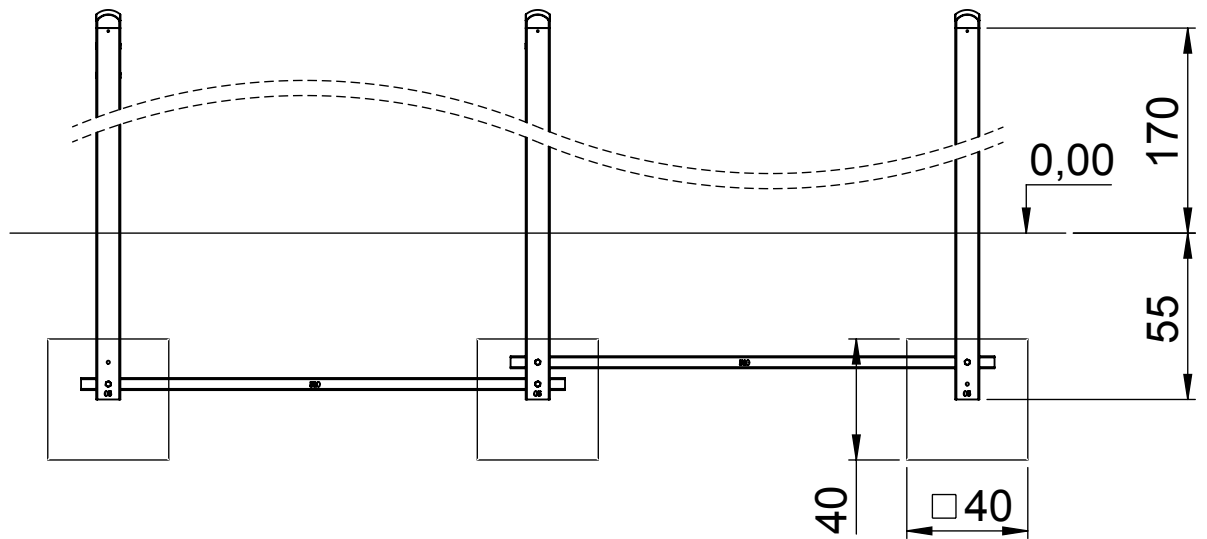

[cm]



play
Vinci

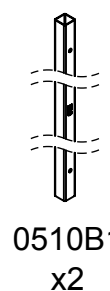
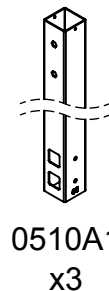
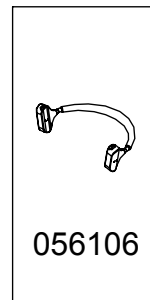
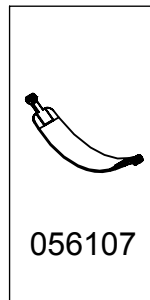
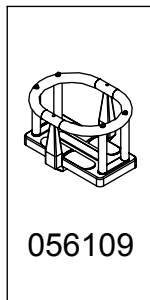
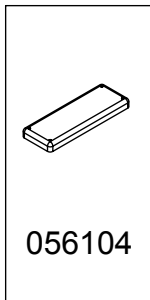

ST/INOX	
2x	E166
2x	E167
2x	E169
R1	
1...2x	E164
R2	
1...2x	E165
R3	
1...2x	E168
R5	
1...2x	E164

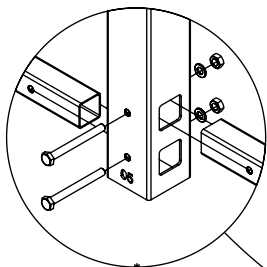
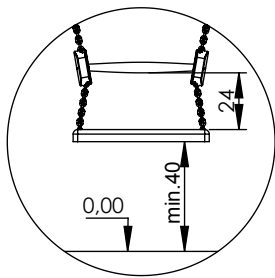

E169

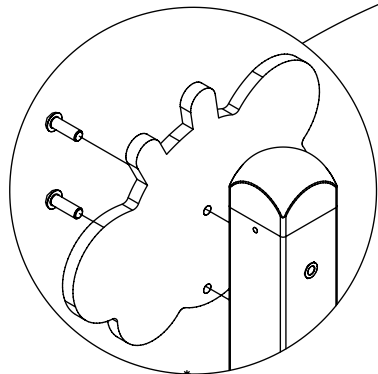
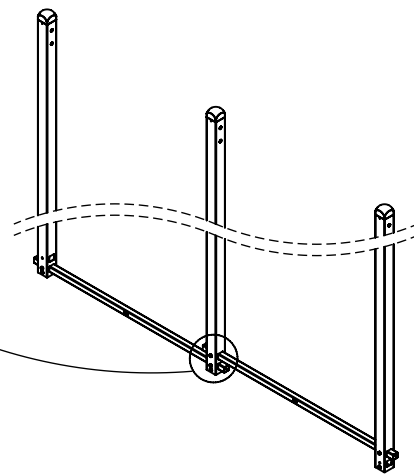

E167

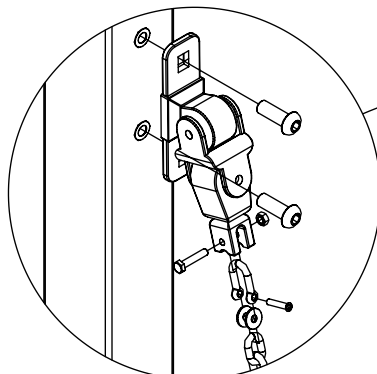

E166

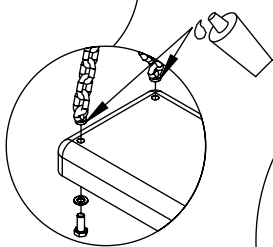
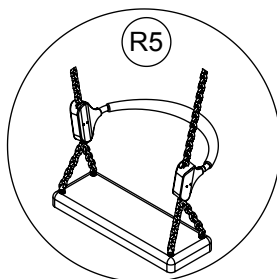
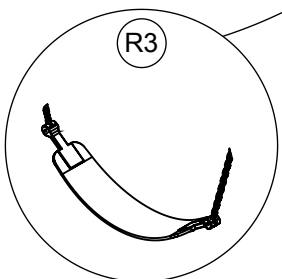
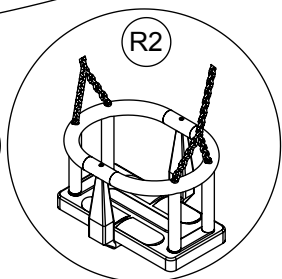
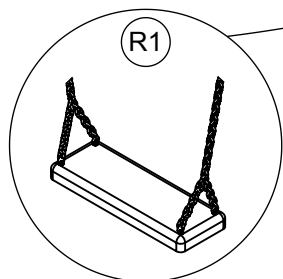
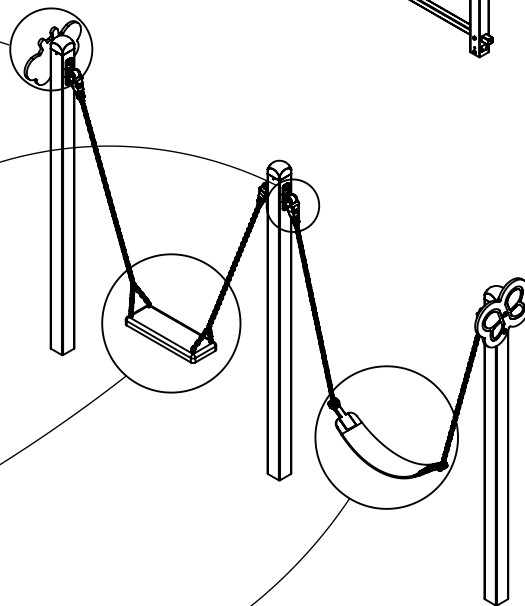

E164

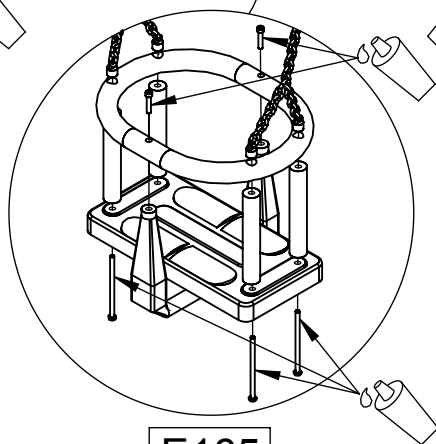

E165

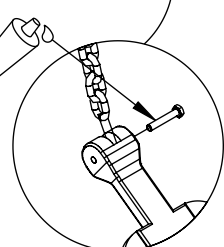

E168

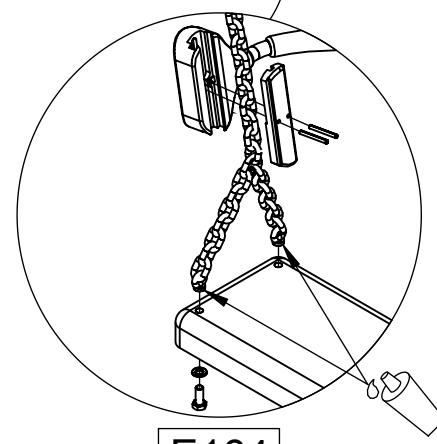

E164



[cm]

play
vinici