

ROBINIA RB1327



1+



8 kids



21,5 m²



Material specification

- Construction made of Robinia - very durable acacia wood with a diameter of ~ 18 cm without sharp edges, resistant to weather conditions,
- Platforms made of Robinia - very durable acacia wood, resistant to weather conditions,
- Transparent polycarbonate panels with a weather-resistant print,
- Side panels made of Robinia - very durable acacia wood without sharp edges, resistant to weather conditions
- Educational panels and moving elements made of HPL plate, resistant to weather conditions,
- Elements made of safe, certified rubber with textile reinforcement,
- Steel ropes in polypropylene braid, connected with durable plastic elements, stainless steel or aluminum,
- Calibrated stainless steel chains, preventing fingers entrapment,
- Stainless steel bars,
- Screws covered with plastic caps and/or stainless steel screws,



Facilitating disability



easy access



integration



Intellectual development



manipulation



sensorics



thinking



Physical development



community





5
number of interactive elements

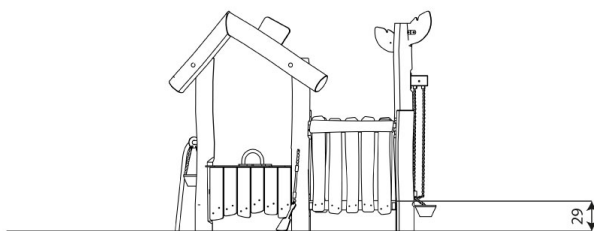
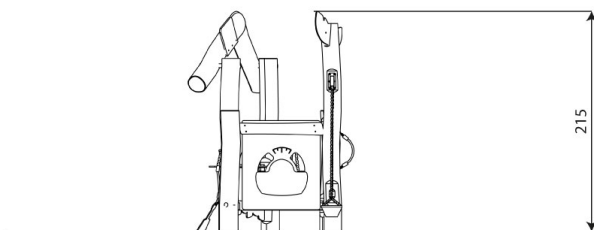
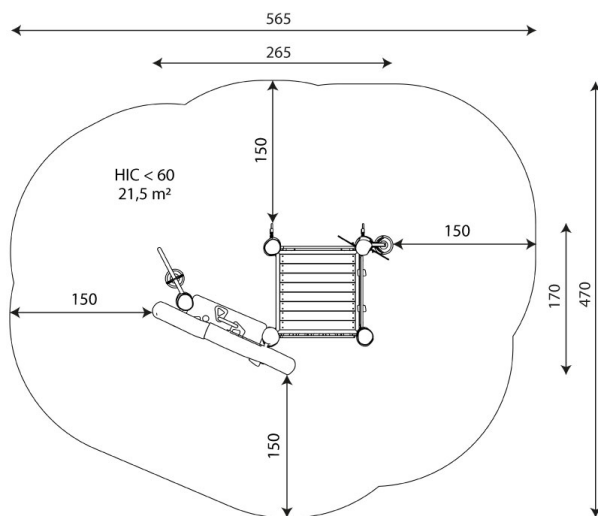

Product technical sheet

ROBINIA RB1327

Product data

Length	265 cm
Width	170 cm
Total height	215 cm
Age group	1+ years
Number of users	8 kids
Safety zone	21,5 m2
Free fall height	< 60 cm
The height of the platforms	29 cm
In accordance with norm EN	1176-1:2017
Weight of the heaviest part	61 kg
Dimensions of the largest part	270x18x18 cm
Availability of spare parts	YES
Installation time	3 h

Data is subject to change without prior notice.

Additional information

- equipment adapted for the disabled; intended for public playgrounds;
- equipment has a certificate issued by an accredited entity or a declaration of conformity;
- no sharp edges or chinks that would pose a danger of jimmie the head, fingers or any other body parts;
- anchoring on flat surface, 80/70/60 cm deep;
- render is for reference only, the actual appearance of the equipment and its color may vary;

Guarantee

30 30 year guarantee - Structural strength of steel and stainless steel components

15 15 year guarantee - Structural failure of steel and stainless steel, for dynamic equipment

10 10 year guarantee - Structural failure of high density polyethylene and high pressure laminates components

5 5 year guarantee - Corrosion of stainless steel and hot dip galvanized and powder coated components; against bark beetles and rot in case of wooden structural elements

Detailed information in the guarantee card



Surfaces according to EN 1176-1:2017

	Description (mm)	Layer thickness (cm)	Maximum fall heights (cm)
Turf/ top layer of soil (A,B,C)	-	-	≤100
bark (A,C)	Particle size from 20 to 80	30	≤200
		40	≤300
woodchips (A,C)	Particle size from 5 to 30	30	≤200
		40	≤300
sand or gravel (A,C)	Particle size from 0,25 to 8	30	≤200
		40	≤300
synthetic attested (A,B,C)	Tested according to EN 1177		< 60

Product technical sheet

ROBINIA RB1327

Amount of safe surface corresponding with free fall height:

HIC <60 21,5 m²

Data is subject to change without prior notice.

