

price list 2026

Seating

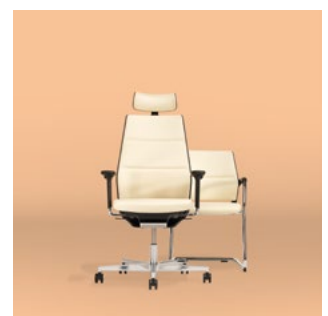

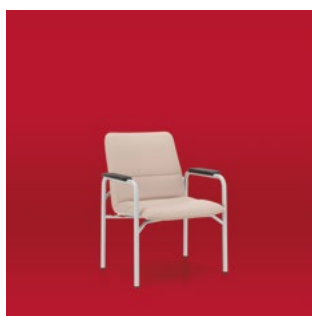
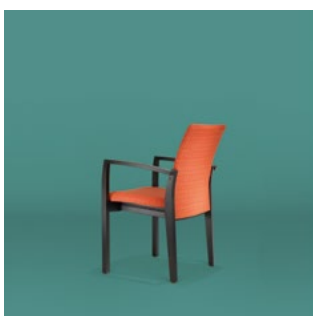
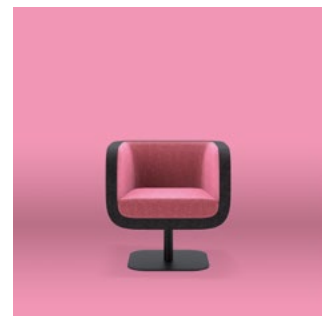
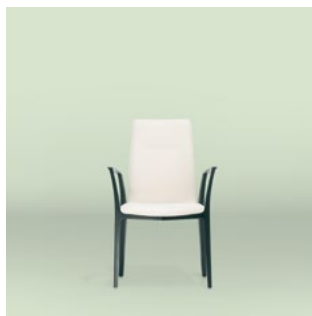
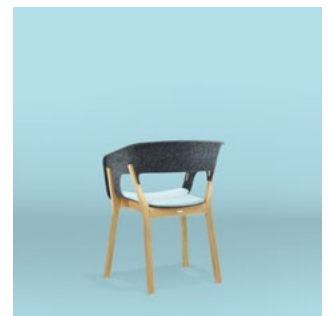
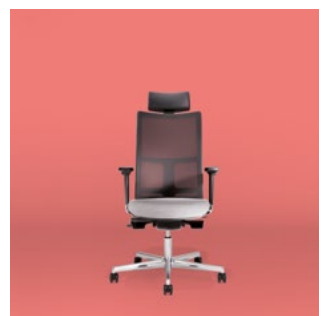
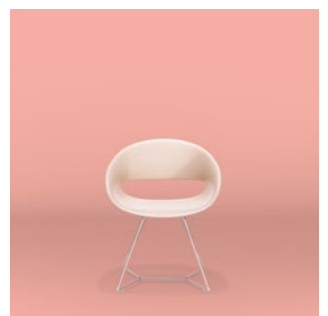
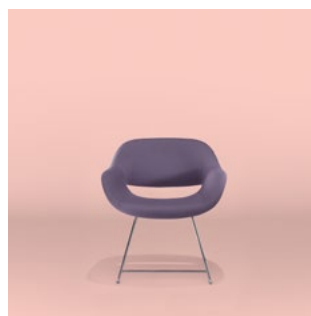
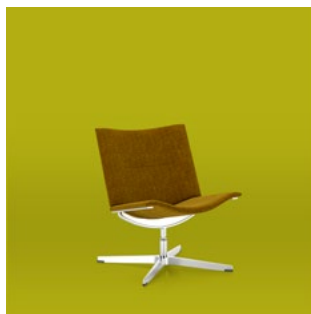

Tables



Walls



Supplementary products/informations



beWise price list 2026

Chair on 4 metal legs, plywood shell



BEWISE FRAME CHAIR 4L W



BEWISE FRAME CHAIR 4LA W

Chair on 4 metal legs, upholstered



BEWISE FRAME CHAIR 4L UPH



BEWISE FRAME CHAIR 4LA UPH

Price list

beWise chair on 4 metal legs, plywood shell

Shell made of beech plywood.
4-leg frame made of powder-coated or chromium plated steel,
with or without armrests, stackable, with plastic glides.
Possibility of connecting into rows with an integrated plastic element.



| | | BEWISE FRAME CHAIR 4L W | | BEWISE FRAME CHAIR 4LA W | | | |
|------------------------------|---|---|---------|---|----|----|----|
| | | W 535 mm D 560 mm H 835 mm SH 445 mm SH DIN 410 mm WT 5,6 kg | | W 590 mm D 560 mm H 835 mm SH 445 mm SH DIN 410 mm WT 7,1 kg | | | |
| | | Basic price (EUR) | | | | | |
| | | 156 | | 185 | | | |
| Frame | Steel | powder-coated | E-③ | | • | • | |
| | | chromium plated | E-CR | | 17 | 25 | |
| Shell | Beech plywood | Natural | • | | • | • | |
| | | Stained | CC-① | | 17 | 17 | |
| | | Laminated | ◦ | | ◦ | ◦ | |
| Brak | | • | | – | • | – | |
| Seat and backrest pad | Upholstered | 2 | SE-PD-⑤ | | 50 | 50 | |
| | | 3 | – | | 54 | 54 | |
| | | 4 | – | | 58 | 58 | |
| | | 5 | – | | 62 | 62 | |
| | Upholstered seat and backrest pads | Price group | 2 | BA-PD-⑤ | | 62 | 62 |
| | | | 3 | SE-PD-⑤ | | 70 | 70 |
| | | | 4 | – | | 78 | 78 |
| | | | 5 | – | | 91 | 91 |
| | Upholstered seat and backrest pad (one element) | – | 2 | BS-PD-⑤ | | 66 | 66 |
| | | | 3 | – | | 74 | 74 |
| | | | 4 | – | | 82 | 82 |
| | | | 5 | – | | 95 | 95 |
| Armrest pads | Black plastic | AP-KB | | – | • | | |
| | Plywood in shell finish | AP-① | | – | 29 | | |
| Seat numbering | None | • | | • | • | | |
| | Shell preparation for magnetic numbering | NO | | 10 | 10 | | |

- ① – Please specify wood colour code – [see finishes](#)
 ③ – Please specify metal colour code – [see finishes](#)
 ⑤ – Please specify upholstery colour code from selected price group – [see finishes](#)

- Available as standard (included in basic price)
- Available as an option (included in basic price)

Price list

| | | | | BEWISE FRAME CHAIR 4L W | | | BEWISE FRAME CHAIR 4LA W | | | |
|--------------------------------------|---|-----------------------------------|------|----------------------------|----|----|-----------------------------|----|----|----|
| Glides | Plastic with felt | GDF | | ● | | | ● | | | |
| | Protect | GDT | | ○ | | | ○ | | | |
| Foam | None | | ● | — | | | ● | — | | |
| | Standard foam | FSTD | | ○ | | | | ○ | | |
| | Flame retardant foam | FFR2 | — | 7 | 9 | 9 | — | 7 | 9 | 9 |
| | Flame retardant foam with fireproof fabric* | FFRF | | 28 | 46 | 46 | | 28 | 46 | 46 |
| Wood and wood-based materials | Raw material – EU timber regulation, from certified forests, FSC certificate – authorized companies | not applicable to Laminated shell | FSC | ● | | | ● | | | |
| | Raw material - EU Timber regulation | only Laminated shell | EUTR | ○ | | | ○ | | | |
| Assembly | Assembled | ASM-F | | ● | | | ● | | | |
| Sample order | BEWISE FRAME CHAIR 4L W (E-BL CC-U999 SE-PD-CUR60112 AP-KB GDF FSC ASM-F) | | | | | | | | | |

*increased fire-resistance parameters in accordance with DIN 66084 P-a for some upholstery arrangements i.e. Cura, Valencia, Xtreme, Main Line Flax, Step/Step Melange, skai Parotega, Synergy

- Available as standard (included in basic price)
- Available as an option (included in basic price)

beWise chair on 4 metal legs, upholstered

Upholstered shell.
4-leg frame made of powder-coated or chromium plated steel,
with or without armrests, stackable, with plastic glides.
Possibility of connecting into rows with an integrated plastic element.



| BEWISE FRAME CHAIR 4L UPH | BEWISE FRAME CHAIR 4LA UPH |
|---|---|
| W 535 mm D 565 mm H 840 mm SH 465 mm SH DIN 430 mm WT 6,5 kg | W 590 mm D 565 mm H 840 mm SH 465 mm SH DIN 430 mm WT 8,0 kg |

| Basic price (EUR) according to upholstery price group | | |
|--|-----|-----|
| 2 | 200 | 230 |
| 3 | 211 | 241 |
| 4 | 218 | 248 |
| 5 | 230 | 259 |

| | | | | | |
|--------------------------------------|---|-----------------|-------|----|----|
| Frame | Steel | powder-coated | E-③ | • | • |
| | | chromium plated | E-CR | 17 | 25 |
| Shell | Upholstered | | BS-⑤ | • | • |
| | Black plastic | | AP-KB | | • |
| Armrest pads | Beech plywood | Natural | AP-① | — | 29 |
| | | Stained | | | |
| Seat numbering | None | | | • | • |
| | Shell preparation for magnetic numbering | | NO | 10 | 10 |
| Glides | Plastic with felt | | GDF | • | • |
| | Protect | | GDT | ◦ | ◦ |
| Foam | Standard foam | | FSTD | • | • |
| | Flame retardant foam | | FFR2 | 9 | 9 |
| | Flame retardant foam with fireproof fabric* | | FFRF | 46 | 46 |
| Wood and wood-based materials | Raw material – EU Timber regulation, from certified forests, FSC certificate – authorized companies | | FSC | • | • |
| Assembly | Assembled | | ASM-F | • | • |
| Sample order | BEWISE FRAME CHAIR 4L UPH (E-BL BS-CUR60112 GDF FSTD FSC ASM-F) | | | | |

*increased fire-resistance parameters in accordance with DIN 66084 P-a for some upholstery arrangements i.e. Cura, Valencia, Xtreme, Main Line Flax, Step/Step Melange, skai Parotega, Synergy

- ① – Please specify wood colour code – [see finishes](#)
 ③ – Please specify metal colour code – [see finishes](#)
 ⑤ – Please specify upholstery colour code from selected price group – [see finishes](#)

- Available as standard (included in basic price)
- Available as an option (included in basic price)

Price list

beWise seat numbering

Seat numbering set includes one piece of each number in ranges:
 - from 1 to 10,
 - from 1 to 15,
 - from 1 to 20.

Magnetic numbering is assembled to specially designed places on chair backrests.
 The set includes a reusable box for storing the numbering.



CHAIR ACCESSORY NUM SEAT 1

Basic price (EUR)

| Numbering range | | | | Basic price (EUR) |
|-----------------|------|--|----|-------------------|
| | 1-10 | | 10 | 58 |
| | 1-15 | | 15 | 82 |
| | 1-20 | | 20 | 107 |

beWise row numbering

Row numbering set includes one piece of each number in the ranges:
 - from 1 to 10,
 - from 1 to 15,
 - from 1 to 20.

Numbering is assembled to a plastic element in the chair frame.
 The set includes a reusable box for storing the numbering.



CHAIR ACCESSORY NUM ROW 1

Basic price (EUR)

| Numbering range | | | | Basic price (EUR) |
|-----------------|------|--|----|-------------------|
| | 1-10 | | 10 | 103 |
| | 1-15 | | 15 | 136 |
| | 1-20 | | 20 | 173 |

beWise magnetic pen

Magnetic pen is used to take off the seat numbering from chair backrest for storage and reuse purposes after rearranging chair positioning.



CHAIR ACCESSORY MGPEN 1

Basic price (EUR)

46

beWise row separator

The set includes 2 pcs of row separator used for arranging and keeping distance between rows.



CHAIR ACCESSORY ROW SEP 1

Basic price (EUR)

41

| Distance | | | | | |
|----------|-----------------------------------|-----------|----------|----|---|
| | For chairs without writing tablet | | DS-ST | | • |
| | For chairs with writing tablet | | DS-WT | | ◦ |
| Finish | Powder-coated | Jet black | RAL 9005 | BL | • |

beWise writing tablet

Folding Anti-Panic writing tablet for right or left hand version.
 Writing tablet assembled to free standing chairs or chairs connected into rows, with or without armrests.
 No stacking possibility for chair with writing tablet



CHAIR ACCESSORY WT 1

Basic price (EUR)

101

| | | | | | |
|--------------------------------------|-------------------------------------|-----------|----------|------|---|
| Table top finish | Laminate | | | U999 | • |
| Tablet arm finish | Powder-coated | Jet black | RAL 9005 | BL | • |
| Version | Right | | | V-R | • |
| | Left | | | V-L | ◦ |
| Wood and wood-based materials | Raw material – EU Timber regulation | | | EUTR | • |

- Available as standard (included in basic price)
- Available as an option (included in basic price)

beWise clamp for connecting into rows

Clamp – additional stabilization of chairs connected into rows, in accordance with EN14703 standard.
 Set includes 2 pcs, to link front and rear legs.



CHAIR ACCESSORY ROW CLAMP 1

Basic price (EUR)

9

| | | | | | |
|---------------|---------|-------|--|---|--|
| Finish | Plastic | Black | | B | |
|---------------|---------|-------|--|---|--|

Finishes

Wood

Natural



SKNB
Natural Beech

Stained



2.07Y
Black



2.06S
Slate



S39
Light Grey



2.09S
White



2.0CB
Acacia



SK40
Oak



2.0CC
Walnut

Laminate

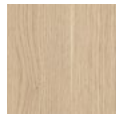

H3349
Kaisersberg
Oak



H1733
Mainau Birch

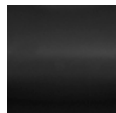

U999
Black



U963
Dark Grey

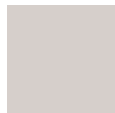

U708
Light Grey



U626
Kiwi Green



U504
Tyrolean
Blue

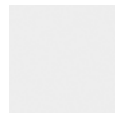

W1000
Premium
White

Metal



**NCS S
2005-Y60R**
Cashmere
NK



RAL 1024
Ochre Yellow
OY



**RAL 030 50
40**
Vermilion Red
VR



RAL 6003
Olive Green
OG



RAL 5000
Violet Blue
VB



Chrome
CR



RAL 9006
White
Aluminium
WK



DB 703
Iron Mica
IM



RAL 9005
Jet Black
BL

Plastic



KB
Black

General notes

All specified dimensions are approximate. Subject to minor modifications or differences for reasons of design improvements or for technical reasons.

- W = width
- D = depth
- H = height
- DI = diameter
- SH = seat height
- SH DIN = seat height measured acc. to DIN EN 1335-1
- WT = weight

In compliance with the highest quality standards "Quality is irreplaceable." Guided by this principle, each product line is subjected to stringent quality testing.

Only the products marked in this document are FSC® (FSC®-C120977). Look for our FSC®-certified products. Sale of products that meet the FSC® requirements is possible only by Nowy Styl Sp. z o.o., Nowy Styl Nederland B.V. and Kusch+Co GmbH.



The FSC® certificate applies to responsible forest management and the entire flow of raw materials from the forest to the customer. Each stage of the chain is monitored in terms of social, ecological and economic performance. The product with the FSC® label gives customers a guarantee that the wood used for the production of the product comes from sources managed in a sustainable manner.

Warranty

Manufacturer declares that the products shall be free from defects in material or workmanship. The warranty is given to the original purchaser only, for normal commercial usage. Detailed terms of warranty and warranty periods are available at <https://www.kusch.com/en/warranty>

v-care price list 2026

V-Care

Projekt: Justus Kolberg

Chair on 4 metal legs

kuschmed®
HYGIENIC-LINE



VCARE FRAME CHAIR 4L VCARE FRAME CHAIR 4LA

Chair on sled metal frame



VCARE FRAME CHAIR CFS VCARE FRAME CHAIR CFSA

Benches



VCARE BENCH 2U



VCARE BENCH 3U



VCARE BENCH 4U



VCARE BENCH 5U



VCARE BENCH 2U TE1



VCARE BENCH 3U TE1



VCARE BENCH 4U TE1



VCARE BENCH 5U TE1



VCARE BENCH 2U TE2



VCARE BENCH 3U TE2



VCARE BENCH 4U TE2



VCARE BENCH 5U TE2



VCARE BENCH 1U TB1



VCARE BENCH 2U TB1



VCARE BENCH 3U TB1



VCARE BENCH 4U TB1

V-Care

Projekt: Justus Kolberg

Benches PRM



**VCARE BENCH
PRM 2U**



**VCARE BENCH
PRM 3U**



**VCARE BENCH
PRM 4U**



**VCARE BENCH
PRM 5U**



**VCARE BENCH
PRM 2U TE1**



**VCARE BENCH
PRM 3U TE1**



**VCARE BENCH
PRM 4U TE1**



**VCARE BENCH PRM
5U TE1**



**VCARE BENCH
PRM 2U TE2**



**VCARE BENCH
PRM 3U TE2**



**VCARE BENCH
PRM 4U TE2**



**VCARE BENCH
PRM 5U TE2**



**VCARE BENCH
PRM 1U TB1**



**VCARE BENCH
PRM 2U TB1**



**VCARE BENCH
PRM 3U TB1**



**VCARE BENCH
PRM 4U TB1**

Accessories



**BENCH ACCESSORY
BTB 2**

V-Care Fold

Plywood benches, assembly to wall



VCARE BEAM SEATING
1U MW W



VCARE BEAM SEATING
2U MW W



VCARE BEAM SEATING
3U MW W



VCARE BEAM SEATING
4U MW W



VCARE BEAM SEATING
5U MW W



VCARE BEAM SEATING
6U MW W

Plywood benches, assembly to floor



VCARE BEAM SEATING
1U MF W



VCARE BEAM SEATING
2U MF W



VCARE BEAM SEATING
3U MF W



VCARE BEAM SEATING
4U MF W



VCARE BEAM SEATING
5U MF W



VCARE BEAM SEATING
6U MF W

Plywood benches, freestanding



VCARE BEAM SEATING
2U FS W



VCARE BEAM SEATING
3U FS W



VCARE BEAM SEATING
4U FS W



VCARE BEAM SEATING
5U FS W



VCARE BEAM SEATING
6U FS W

Upholstered benches, assembly to wall



VCARE BEAM SEATING
1U MW UPH



VCARE BEAM SEATING
2U MW UPH



VCARE BEAM SEATING
3U MW UPH



VCARE BEAM SEATING
4U MW UPH



VCARE BEAM SEATING
5U MW UPH



VCARE BEAM SEATING
6U MW UPH

Upholstered benches, assembly to floor



VCARE BEAM SEATING
1U MF UPH



VCARE BEAM SEATING
2U MF UPH



VCARE BEAM SEATING
3U MF UPH



VCARE BEAM SEATING
4U MF UPH



VCARE BEAM SEATING
5U MF UPH



VCARE BEAM SEATING
6U MF UPH

Upholstered benches, freestanding



VCARE BEAM SEATING
2U FS UPH



VCARE BEAM SEATING
3U FS UPH



VCARE BEAM SEATING
4U FS UPH



VCARE BEAM SEATING
5U FS UPH



VCARE BEAM SEATING
6U FS UPH

V-care chair on 4 metal legs

Seat shell with antibacterial properties, made of flame-retardant polyurethane.
4-leg frame made of powder-coated or Chrome steel,
with or without armrests, stackable, with plastic glides.



| | | | VCARE FRAME CHAIR 4L | VCARE FRAME CHAIR 4LA |
|---------------------|--|---------------|---|--|
| | | | W 520 mm D 575 mm H 860 mm SH 460 mm SH DIN 430 mm WT 8,5 kg | W 627 mm D 565 mm H 860 mm SH 460 mm SH DIN 430 mm WT 9,45 kg |
| | | | Basic price (EUR) | |
| | | | 315 | 380 |
| Seat height | 460 mm | SH460 | • | • |
| | 510 mm | SH510 | 39 | 39 |
| | 560 mm | SH560 | 39 | 39 |
| Frame | Steel | powder-coated | E- ^③ | • |
| | | chrome | E-CR | 18 |
| Seat shell | Flame retardant polyurethane foam | | CC- ^④ | • |
| Armrests | Made of plastic in shell colour, with antibacterial properties | | ARF-AB- ^④ | • |
| | Made of black plastic, with antibacterial properties | | | ◦ |
| Glides | Plastic | | GD | • |
| | Plastic with felt | | GDF | 7 |
| Assembly | Assembled | | ASM-F | • |
| Sample order | VCARE FRAME CHAIR 4L (SH460 E-WK CC-KG GD ASM-F) | | | |

^③ – Please specify metal colour code – [see finishes](#)

^④ – Please specify plastic colour code – [see finishes](#)

• Available as standard (included in basic price)

◦ Available as an option (included in basic price)

V-care chair on sled metal frame

Seat shell with antibacterial properties, made of flame-retardant polyurethane.
4-leg frame made of powder-coated or Chrome steel,
with or without armrests, stackable, with plastic glides.



| VCARE FRAME CHAIR CFS | VCARE FRAME CHAIR CFSA |
|---|---|
| W 510 mm D 572 mm H 860 mm SH 460 mm SH DIN 430 mm WT 9,8 kg | W 593 mm D 572 mm H 860 mm SH 460 mm SH DIN 430 mm WT 10,45 kg |
| Basic price (EUR) | |
| 356 | 388 |

| | | | | | |
|---------------------|--|---------------|----------------------|----|----|
| Frame | Steel | powder-coated | E- ^③ | • | • |
| | | chrome | E-CR | 18 | 18 |
| Seat shell | Flame retardant polyurethane foam | | CC- ^④ | • | • |
| Armrests | Made of plastic in shell colour, with antibacterial properties | | ARF-AB- ^④ | — | • |
| | Made of black plastic, with antibacterial properties | | | — | ○ |
| Glides | Plastic | | GD | • | • |
| | Plastic with felt | | GDF | 7 | 7 |
| Assembly | Assembled | | ASM-F | • | • |
| Sample order | VCARE FRAME CHAIR CFSA (E-WK CC-KG ARF-AB-KG GDF ASM-F) | | | | |

^③ – Please specify metal colour code – [see finishes](#)

^④ – Please specify plastic colour code – [see finishes](#)

• Available as standard (included in basic price)

○ Available as an option (included in basic price)

Price list

V-Care bench 2U



VCARE BENCH 2U

W 1110 mm
D 610 mm
H 820 mm
SH 460 mm
SH DIN 420 mm
WT 28,00 kg

Basic price (EUR)

1029

| | | | | | |
|---------------------|--|-------------------------|---|-------------------------------|-----|
| Frame | Powder-coated steel | | E- ^③ | • | |
| Shell | PU foam | | CC- ^④ | • | |
| Armrests | None | | | • | |
| | 2 external armrests | Powder-coated aluminium | AE-J2- ^③ | 112 | |
| | 2 external armrests 1 internal armrest | Powder-coated aluminium | AI-J1- ^③ AE- J2- ^③ | 168 | |
| Media | None | | | • | |
| | 1 media port | 1 module | 1× TUF double USB charger (type A+C) | J1-BS-YKU012- ^⑧ | 365 |
| | | 2 modules | 1× power socket 1× USB charger (type C) | J1-BS-YKU013- ^⑧ | 179 |
| Cable outlet | None | | | • | |
| | Left | | BO-L | ◦ | |
| | Right | | BO-R | | |
| Glides | Plastic | | GD | • | |
| | Plastic nonskid | | GDN | 16 | |
| | Floor fixing glued | | GDG | 66 | |
| | Floor fixing screwed | | GDS | 46 | |
| | Floor fixing magnetic | | GDMG | 156 | |
| Wall spacer | None | | | • | |
| | Wall spacer (available only for GD and GDN glides) | | IN-WS | 108 | |
| Assembly | Assembled | | ASM-F | • | |
| | Unassembled | | ASM-U | ◦ | |
| Sample order | VCARE BENCH 2U (E-BL CC-KG GD IN-WS ASM-F) | | | | |

^③ – Please specify metal colour code – [see finishes](#)

^④ – Please specify plastic colour code – [see finishes](#)

^⑧ – Please specify media port standard: FR, GB, GE

• Available as standard (included in basic price)

◦ Available as an option (included in basic price)

V-Care bench 3U



VCARE BENCH 3U

W 1680 mm
D 610 mm
H 820 mm
SH 460 mm
SH DIN 420 mm
WT 38,20 kg

Basic price (EUR)

1386

| | | | | |
|---------------------|--|-------------------------|--|-----|
| Frame | Powder-coated steel | | E-(3) | • |
| Shell | PU foam | | CC-(4) | • |
| Armrests | None | | | • |
| | 2 external armrests | Powder-coated aluminium | AE-J2-(3) | 112 |
| | 2 external armrests 2 internal armrests | Powder-coated aluminium | AI-J2-(3) AE-J2-(3) | 224 |
| Media | None | | | • |
| | 2 media ports | 1 module | 1× TUF double USB charger (type A+C) J2-BS-YKU012-(8) | 478 |
| | | 2 modules | 1× power socket 1× USB charger (type C) J2-BS-YKU013-(8) | 308 |
| Cable outlet | None | | | • |
| | Left | | BO-L | ◦ |
| | Right | | BO-R | |
| Glides | Plastic | | GD | • |
| | Plastic nonskid | | GDN | 16 |
| | Floor fixing glued | | GDG | 66 |
| | Floor fixing screwed | | GDS | 46 |
| | Floor fixing magnetic | | GDMG | 156 |
| Wall spacer | None | | | • |
| | Wall spacer (available only for GD and GDN glides) | | IN-WS | 108 |
| Assembly | Assembled | | ASM-F | • |
| | Unassembled | | ASM-U | ◦ |
| Sample order | VCARE BENCH 3U (E-BL CC-KG AE-J2-BL BO-L GD IN-WS ASM-F) | | | |

(3) - Please specify metal colour code - [see finishes](#)

(4) - Please specify plastic colour code - [see finishes](#)

(8) - Please specify media port standard: FR, GB, GE

• Available as standard (included in basic price)

◦ Available as an option (included in basic price)

Price list

V-Care bench 4U



VCARE BENCH 4U

W 2250 mm
D 610 mm
H 820 mm
SH 460 mm
SH DIN 420 mm
WT 48,40 kg

Basic price (EUR)

1742

| | | | | |
|---------------------|--|---|-----------------|-----|
| Frame | Powder-coated steel | | E-③ | • |
| Shell | PU foam | | CC-④ | • |
| Armrests | None | | | • |
| | 2 external armrests | Powder-coated aluminium | AE-J2-③ | 112 |
| | 2 external armrests 3 internal armrests | Powder-coated aluminium | AI-J3-③ AE-J2-③ | 280 |
| Media | None | | | • |
| | 2 media ports | 1 module 1× TUF double USB charger (type A+C) | J2-BS-YKU012-⑧ | 478 |
| | | 2 modules 1× power socket 1× USB charger (type C) | J2-BS-YKU013-⑧ | 308 |
| Cable outlet | None | | | • |
| | Left | | BO-L | ◦ |
| | Right | | BO-R | |
| Glides | Plastic | | GD | • |
| | Plastic nonskid | | GDN | 16 |
| | Floor fixing glued | | GDG | 66 |
| | Floor fixing screwed | | GDS | 46 |
| | Floor fixing magnetic | | GDMG | 156 |
| Wall spacer | None | | | • |
| | Wall spacer (available only for GD and GDN glides) | | IN-WS | 108 |
| Assembly | Assembled | | ASM-F | • |
| | Unassembled | | ASM-U | ◦ |
| Sample order | VCARE BENCH 4U (E-BL CC-KG AE-J2-BL GDN ASM-F) | | | |

③ – Please specify metal colour code – [see finishes](#)

④ – Please specify plastic colour code – [see finishes](#)

⑧ – Please specify media port standard: FR, GB, GE

- Available as standard (included in basic price)
- Available as an option (included in basic price)

V-Care bench 5U



VCARE BENCH 5U

W 2820 mm
D 610 mm
H 820 mm
SH 460 mm
SH DIN 420 mm
WT 58,6 kg

Basic price (EUR)

2098

| | | | | |
|---------------------|--|-------------------------|--|-----|
| Frame | Powder-coated steel | | E-(3) | • |
| Shell | PU foam | | CC-(4) | • |
| Armrests | None | | | • |
| | 2 external armrests | Powder-coated aluminium | AE-J2-(3) | 112 |
| | 2 external armrests 4 internal armrests | Powder-coated aluminium | AI-J4-(3) AE-J2-(3) | 336 |
| Media | None | | | • |
| | 2 media ports | 1 module | 1× TUF double USB charger (type A+C) J2-BS-YKU012-(8) | 478 |
| | | 2 modules | 1× power socket 1× USB charger (type C) J2-BS-YKU013-(8) | 308 |
| Cable outlet | None | | | • |
| | Left | | BO-L | ◦ |
| | Right | | BO-R | ◦ |
| Glides | Plastic | | GD | • |
| | Plastic nonskid | | GDN | 24 |
| | Floor fixing glued | | GDG | 66 |
| | Floor fixing screwed | | GDS | 46 |
| | Floor fixing magnetic | | GDMG | 234 |
| Wall spacer | None | | | • |
| | Wall spacer (available only for GD and GDN glides) | | IN-WS | 108 |
| Assembly | Assembled | | ASM-F | • |
| | Unassembled | | ASM-U | ◦ |
| Sample order | VCARE BENCH 5U (E-BL CC-KG AE-J2-BL GDN ASM-F) | | | |

(3) – Please specify metal colour code – [see finishes](#)

(4) – Please specify plastic colour code – [see finishes](#)

(8) – Please specify media port standard: FR, GB, GE

• Available as standard (included in basic price)

◦ Available as an option (included in basic price)

Price list

V-Care bench 2U with external table



VCARE BENCH 2U TE1

W 1530 mm
D 610 mm
H 820 mm
SH 460 mm
SH DIN 420 mm
WT 33,8 kg

Basic price (EUR)

1272

| | | | | | |
|--------------------------------------|---|-------------------------|--|------------------|-----|
| Frame | Powder-coated steel | | E-(3) | • | |
| Shell | PU foam | | CC-(4) | • | |
| External table | 1 piece | Left | Compact Laminat U0901TP | TE-L-U0901TP | • |
| | | Right | Traceless Black | TE-R-U0901TP | ◦ |
| Armrests | None | | | • | |
| | 2 external armrests | Powder-coated aluminium | AE-J2-(3) | 112 | |
| | 2 external armrests 1 internal armrest | Powder-coated aluminium | AI-J1-(3) AE-J2-(3) | 168 | |
| Media | None | | | • | |
| | 1 media port | 1 module | 1× TUF double USB charger (type A+C) | J2-BS-YKU012-(8) | 365 |
| | | 2 modules | 1× power socket 1× USB charger (type C) | J2-BS-YKU013-(8) | 179 |
| Cable outlet | None | | | • | |
| | Left | | BO-L | ◦ | |
| | Right | | BO-R | ◦ | |
| Glides | Plastic | | GD | • | |
| | Plastic nonskid | | GDN | 16 | |
| | Floor fixing glued | | GDG | 66 | |
| | Floor fixing screwed | | GDS | 46 | |
| | Floor fixing magnetic | | GDMG | 156 | |
| Wall spacer | None | | | • | |
| | Wall spacer (available only for GD and GDN glides) | | IN-WS | 108 | |
| Wood and wood-based materials | Raw material – EU timber regulation, from certified forests, FSC certificate – authorized companies | | FSCMIX | • | |
| Assembly | Partially assembled | | ASM-P | • | |
| | Unassembled | | ASM-U | ◦ | |

Sample order VCARE BENCH 2U TE1 (E-BL CC-KG TE-L-U0901TP GD IN-WS ASM-F)

(3) – Please specify metal colour code – [see finishes](#)

(4) – Please specify plastic colour code – [see finishes](#)

(8) – Please specify media port standard: FR, GB, GE

• Available as standard (included in basic price)

◦ Available as an option (included in basic price)

V-Care bench 3U with external table



VCARE BENCH 3U TE1

W 2100 mm
D 610 mm
H 820 mm
SH 460 mm
SH DIN 420 mm
WT 44,0 kg

Basic price (EUR)

1629

| | | | | | |
|--------------------------------------|---|-------------------------|--|----------------|-----|
| Frame | Powder-coated steel | | E-③ | • | |
| Shell | PU foam | | CC-④ | • | |
| External table | 1 piece | Left | Compact Laminat U0901TP | TE-L-U0901TP | • |
| | | Right | Traceless Black | TE-R-U0901TP | ○ |
| Armrests | None | | | • | |
| | 2 external armrests | Powder-coated aluminium | AE-J2-③ | 112 | |
| | 2 external armrests 2 internal armrests | Powder-coated aluminium | AI-J2-③ AE-J2-③ | 224 | |
| Media | None | | | • | |
| | 2 media ports | 1 module | 1× TUF double USB charger (type A+C) | J2-BS-YKU012-⑧ | 478 |
| | | 2 modules | 1× power socket 1× USB charger (type C) | J2-BS-YKU013-⑧ | 308 |
| Cable outlet | None | | | • | |
| | Left | | BO-L | ○ | |
| | Right | | BO-R | ○ | |
| Glides | Plastic | | GD | • | |
| | Plastic nonskid | | GDN | 16 | |
| | Floor fixing glued | | GDG | 66 | |
| | Floor fixing screwed | | GDS | 46 | |
| | Floor fixing magnetic | | GDMG | 156 | |
| Wall spacer | None | | | • | |
| | Wall spacer (available only for GD and GDN glides) | | IN-WS | 108 | |
| Wood and wood-based materials | Raw material – EU timber regulation, from certified forests, FSC certificate – authorized companies | | FSCMIX | • | |
| Assembly | Partially assembled | | ASM-P | • | |
| | Unassembled | | ASM-U | ○ | |
| Sample order | VCARE BENCH 3U TE1 (E-BL CC-KG TE-L-U0901TP AE-J2-BL BO-L GD IN-WS ASM-F) | | | | |

③ – Please specify metal colour code – [see finishes](#)

④ – Please specify plastic colour code – [see finishes](#)

⑧ – Please specify media port standard: FR, GB, GE

• Available as standard (included in basic price)

○ Available as an option (included in basic price)

Price list

V-Care bench 4U with external table



VCARE BENCH 4U TE1

W 2670 mm
D 610 mm
H 820 mm
SH 460 mm
SH DIN 420 mm
WT 54,2 kg

Basic price (EUR)

1985,-

| | | | | | |
|--------------------------------------|---|-------------------------|--|------------------|-----|
| Frame | Powder-coated steel | | E-(3) | • | |
| Shell | PU foam | | CC-(4) | • | |
| External table | 1 piece | Left | Compact Laminat U0901TP | TE-L-U0901TP | • |
| | | Right | Traceless Black | TE-R-U0901TP | ◦ |
| Armrests | None | | | • | |
| | 2 external armrests | Powder-coated aluminium | AE-J2-(3) | 112 | |
| | 2 external armrests 3 internal armrests | Powder-coated aluminium | AI-J3-(3) AE-J2-(3) | 280 | |
| Media | None | | | • | |
| | 2 media ports | 1 module | 1× TUF double USB charger (type A+C) | J2-BS-YKU012-(8) | 478 |
| | | 2 modules | 1× power socket 1× USB charger (type C) | J2-BS-YKU013-(8) | 308 |
| Cable outlet | None | | | • | |
| | Left | | BO-L | ◦ | |
| | Right | | BO-R | | |
| Glides | Plastic | | GD | • | |
| | Plastic nonskid | | GDN | 16 | |
| | Floor fixing glued | | GDG | 66 | |
| | Floor fixing screwed | | GDS | 46 | |
| | Floor fixing magnetic | | GDMG | 156 | |
| Wall spacer | None | | | • | |
| | Wall spacer (available only for GD and GDN glides) | | IN-WS | 108 | |
| Wood and wood-based materials | Raw material – EU timber regulation, from certified forests, FSC certificate – authorized companies | | FSCMIX | • | |
| Assembly | Partially assembled | | ASM-P | • | |
| | Unassembled | | ASM-U | ◦ | |

Sample order VCARE BENCH 4U TE1 (E-BL CC-KG TE-L-U0901TP AE-J2-BL GDN ASM-F)

(3) – Please specify metal colour code – [see finishes](#)

(4) – Please specify plastic colour code – [see finishes](#)

(8) – Please specify media port standard: FR, GB, GE

- Available as standard (included in basic price)
- Available as an option (included in basic price)

V-Care bench 5U with external table



VCARE BENCH 5U TE1

W 3240 mm
D 610 mm
H 820 mm
SH 460 mm
SH DIN 420 mm
WT 64,4 kg

Basic price (EUR)

2341

| | | | | | |
|--------------------------------------|---|-------------------------|--|----------------|-----|
| Frame | Powder-coated steel | | E-③ | • | |
| Shell | PU foam | | CC-④ | • | |
| External table | 1 piece | Left | Compact Laminat U0901TP | TE-L-U0901TP | • |
| | | Right | Traceless Black | TE-R-U0901TP | ○ |
| Armrests | None | | | • | |
| | 2 external armrests | Powder-coated aluminium | AE-J2-③ | 112 | |
| | 2 external armrests 4 internal armrests | Powder-coated aluminium | AI-J4-③ AE-J2-③ | 336 | |
| Media | None | | | • | |
| | 2 media ports | 1 module | 1× TUF double USB charger (type A+C) | J2-BS-YKU012-⑧ | 478 |
| | | 2 modules | 1× power socket 1× USB charger (type C) | J2-BS-YKU013-⑧ | 308 |
| Cable outlet | None | | | • | |
| | Left | | BO-L | ○ | |
| | Right | | BO-R | ○ | |
| Glides | Plastic | | GD | • | |
| | Plastic nonskid | | GDN | 24 | |
| | Floor fixing glued | | GDG | 66 | |
| | Floor fixing screwed | | GDS | 46 | |
| | Floor fixing magnetic | | GDMG | 234 | |
| Wall spacer | None | | | • | |
| | Wall spacer (available only for GD and GDN glides) | | IN-WS | 108 | |
| Wood and wood-based materials | Raw material – EU timber regulation, from certified forests, FSC certificate – authorized companies | | FSCMIX | • | |
| Assembly | Partially assembled | | ASM-P | • | |
| | Unassembled | | ASM-U | ○ | |
| Sample order | VCARE BENCH 5U TE1 (E-BL CC-KG TE-L-U0901TP AE-J2-BL GDN ASM-F) | | | | |

③ – Please specify metal colour code – [see finishes](#)

④ – Please specify plastic colour code – [see finishes](#)

⑧ – Please specify media port standard: FR, GB, GE

• Available as standard (included in basic price)

○ Available as an option (included in basic price)

V-Care bench 2U with external tables



VCARE BENCH 2U TE2

W 1730 mm
D 610 mm
H 820 mm
SH 460 mm
SH DIN 420 mm
WT 39,6 kg

Basic price (EUR)

1515

| | | | | | Basic price (EUR) |
|--------------------------------------|---|----------------|--|---|-------------------|
| | | | | | 1515 |
| Frame | Powder-coated steel | | | E- ^③ | • |
| Shell | PU foam | | | CC- ^④ | • |
| External tables | 2 pieces | Left and right | Laminate Traceless TP Black | TE-LR-U0901TP | • |
| | None | | | | • |
| Armrests | 2 external armrests | | Powder-coated aluminium | AE-J2- ^③ | 112 |
| | 2 external armrests 1 internal armrest | | Powder-coated aluminium | AI-J1- ^③ AE-J2- ^③ | 168 |
| | None | | | | • |
| Media | 1 media port | 1 module | 1× TUF double USB charger (type A+C) | J1-BS-YKU012- ^⑧ | 365 |
| | | 2 modules | 1× power socket 1× USB charger (type C) | J1-BS-YKU013- ^⑧ | 179 |
| | None | | | | • |
| Cable outlet | Left | | | BO-L | • |
| | Right | | | BO-R | ◦ |
| | None | | | | • |
| Glides | Plastic | | | GD | • |
| | Plastic nonskid | | | GDN | 16 |
| | Floor fixing glued | | | GDG | 66 |
| | Floor fixing screwed | | | GDS | 46 |
| | Floor fixing magnetic | | | GDMG | 156 |
| Wall spacer | None | | | | • |
| | Wall spacer (available only for GD and GDN glides) | | | IN-WS | 108 |
| Wood and wood-based materials | Raw material – EU timber regulation, from certified forests, FSC certificate – authorized companies | | | FSCMIX | • |
| Assembly | Assembled | | | ASM-F | • |
| | Unassembled | | | ASM-U | ◦ |
| Sample order | VCARE BENCH 2U TE2 (E-BL CC-KG TE-LRU0901TP GDG FSCMIX ASM-F) | | | | |

^③ – Please specify metal colour code – [see finishes](#)

^④ – Please specify plastic colour code – [see finishes](#)

^⑧ – Please specify media port standard: FR, GB, GE

- Available as standard (included in basic price)
- Available as an option (included in basic price)

Price list

V-Care bench 3U with external tables



VCARE BENCH 3U TE2

W 2300 mm
D 610 mm
H 820 mm
SH 460 mm
SH DIN 420 mm
WT 49,8 kg

Basic price (EUR)

1872

| | | | | | |
|--------------------------------------|---|----------------|--|-----------------|-----|
| Frame | Powder-coated steel | | | E-③ | • |
| Shell | PU foam | | | CC-④ | • |
| External tables | 2 pieces | Left and right | Laminate Traceless TP Black | TE-LR-U0901TP | • |
| | None | | | | • |
| Armrests | 2 external armrests | | Powder-coated aluminium | AE-J2-③ | 112 |
| | 2 external armrests 2 internal armrests | | Powder-coated aluminium | AI-J2-③ AE-J2-③ | 224 |
| | None | | | | • |
| Media | | 1 module | 1 × TUF double USB charger (type A+C) | J2-BS-YKU012-⑧ | 478 |
| | 2 media ports | 2 modules | 1 × power socket 1 × USB charger (type C) | J2-BS-YKU013-⑧ | 308 |
| | None | | | | • |
| Cable outlet | Left | | | BO-L | ◦ |
| | Right | | | BO-R | ◦ |
| | Plastic | | | GD | • |
| | Plastic nonskid | | | GDN | 16 |
| Glides | Floor fixing glued | | | GDG | 66 |
| | Floor fixing screwed | | | GDS | 46 |
| | Floor fixing magnetic | | | GDMG | 156 |
| | None | | | | • |
| Wall spacer | Wall spacer (available only for GD and GDN glides) | | | IN-WS | 108 |
| Wood and wood-based materials | Raw material – EU timber regulation, from certified forests, FSC certificate – authorized companies | | | FSCMIX | • |
| Assembly | Assembled | | | ASM-F | • |
| | Unassembled | | | ASM-U | ◦ |

Sample order VCARE BENCH 3U TE2 (E-AB-BL CC-KG TE-LR-U0901TP AE-J2-AB-BL BO-R GD IN-WS FSCMIX ASM-F)

③ – Please specify metal colour code – [see finishes](#)

④ – Please specify plastic colour code – [see finishes](#)

⑧ – Please specify media port standard: FR, GB, GE

• Available as standard (included in basic price)

◦ Available as an option (included in basic price)

V-Care bench 4U with external tables



VCARE BENCH 4U TE2

W 2870 mm
D 610 mm
H 820 mm
SH 460 mm
SH DIN 420 mm
WT 60,0kg

Basic price (EUR)

2228

| | | | | | |
|--------------------------------------|---|----------------|--|-----------------|-----|
| Frame | Powder-coated steel | | | E-③ | • |
| Shell | PU foam | | | CC-④ | • |
| External tables | 2 pieces | Left and right | Laminate Traceless TP Black | TE-LR-U0901TP | • |
| | None | | | | • |
| Armrests | 2 external armrests | | Powder-coated aluminium | AE-J2-③ | 112 |
| | 2 external armrests 3 internal armrests | | Powder-coated aluminium | AI-J3-③ AE-J2-③ | 280 |
| | None | | | | • |
| Media | 2 media ports | 1 module | 1× TUF double USB charger (type A+C) | J2-BS-YKU012-⑧ | 478 |
| | | 2 modules | 1× power socket 1× USB charger (type C) | J2-BS-YKU013-⑧ | 308 |
| | None | | | | • |
| Cable outlet | Left | | | BO-L | ◦ |
| | Right | | | BO-R | ◦ |
| | None | | | | • |
| Glides | Plastic | | | GD | • |
| | Plastic nonskid | | | GDN | 16 |
| | Floor fixing glued | | | GDG | 66 |
| | Floor fixing screwed | | | GDS | 46 |
| | Floor fixing magnetic | | | GDMG | 156 |
| | None | | | | • |
| Wall spacer | Wall spacer (available only for GD and GDN glides) | | | IN-WS | 108 |
| Wood and wood-based materials | Raw material – EU timber regulation, from certified forests, FSC certificate – authorized companies | | | FSCMIX | • |
| Assembly | Assembled | | | ASM-F | • |
| | Unassembled | | | ASM-U | ◦ |

Sample order VCARE BENCH 4U TE2 (E-AB-BL CC-KG TE-LR-U0901TP AE-J2-AB-BL BO-R GD IN-WS FSCMIX ASM-F)

③ – Please specify metal colour code – [see finishes](#)

④ – Please specify plastic colour code – [see finishes](#)

⑧ – Please specify media port standard: FR, GB, GE

- Available as standard (included in basic price)
- Available as an option (included in basic price)

V-Care bench 5U with external tables



VCARE BENCH 5U TE2

W 3440 mm
D 610 mm
H 820 mm
SH 460 mm
SH DIN 420 mm
WT 70,2 kg

Basic price (EUR)

2584

| | | | | | |
|--------------------------------------|---|----------------|--|------------------------|-----|
| Frame | Powder-coated steel | | E-(3) | • | |
| Shell | PU foam | | CC-(4) | • | |
| External tables | 2 pieces | Left and right | Compact Laminat U0901TP Traceless Black | TE-LR- U0901TP | • |
| | None | | | | • |
| Armrests | 2 external armrests | | Powder-coated aluminium | AE-J2-(3) | 112 |
| | 2 external armrests 4 internal armrests | | Powder-coated aluminium | AI-J4-(3) AE-J2-(3) | 336 |
| | None | | | | • |
| Media | | 1 module | 1 × TUF double USB charger (type A+C) | J2-BS- YKU012-(8) | 478 |
| | 2 media ports | 2 modules | 1 × power socket 1 × USB charger (type C) | J2-BS- YKU013-(8) | 308 |
| | None | | | | • |
| Cable outlet | Left | | | BO-L | ◦ |
| | Right | | | BO-R | |
| | Plastic | | | GD | • |
| | Plastic nonskid | | | GDN | 24 |
| Glides | Floor fixing glued | | | GDG | 66 |
| | Floor fixing screwed | | | GDS | 46 |
| | Floor fixing magnetic | | | GDMG | 234 |
| | None | | | | • |
| Wall spacer | Wall spacer (available only for GD and GDN glides) | | | IN-WS | 108 |
| Wood and wood-based materials | Raw material – EU timber regulation, from certified forests, FSC certificate – authorized companies | | | FSCMIX | • |
| | Assembled | | | ASM-F | • |
| Assembly | Unassembled | | | ASM-U | ◦ |

Sample order VCARE BENCH 5U TE2 (E-AB-BL CC-KG TE-LR-U0901TP AE-J2-AB-BL BO-R GD IN-WS FSCMIX ASM-F)

(3) – Please specify metal colour code – [see finishes](#)

(4) – Please specify plastic colour code – [see finishes](#)

(8) – Please specify media port standard: FR, GB, GE

• Available as standard (included in basic price)

◦ Available as an option (included in basic price)

Price list

V-Care bench 1U with big table



VCARE BENCH 1U TB1

W 1110 mm
D 610 mm
H 820 mm
SH 460 mm
SH DIN 420 mm
WT 26,0kg

Basic price (EUR)

871

| | | | | | |
|--------------------------------------|---|-------------------------|--|----------------|-----|
| Frame | Powder-coated steel | | E-③ | • | |
| Shell | PU foam | | CC-④ | • | |
| Big table | Laminate Traceless TP Black | | TB-U0901TP | • | |
| Armrests | None | | | • | |
| | 1 external armrest | Powder-coated aluminium | AE-J1-③ | 56 | |
| | 1 external armrest 1 internal armrest | Powder-coated aluminium | AI-J1-③ AE-J1-③ | 112 | |
| Media | None | | | • | |
| | 1 media port | 1 module | 1× TUF double USB charger (type A+C) | J1-BS-YKU012-⑧ | 365 |
| | | 2 modules | 1× power socket 1× USB charger (type C) | J1-BS-YKU013-⑧ | 179 |
| Cable outlet | None | | | • | |
| | Left | | BO-L | ◦ | |
| | Right | | BO-R | | |
| Glides | Plastic | | GD | • | |
| | Plastic nonskid | | GDN | 16 | |
| | Floor fixing glued | | GDG | 66 | |
| | Floor fixing screwed | | GDS | 46 | |
| | Floor fixing magnetic | | GDMG | 156 | |
| Wall spacer | None | | | • | |
| | Wall spacer (available only for GD and GDN glides) | | IN-WS | 108 | |
| Wood and wood-based materials | Raw material – EU timber regulation, from certified forests, FSC certificate – authorized companies | | FSCMIX | • | |
| Assembly | Assembled | | ASM-F | • | |
| | Unassembled | | ASM-U | ◦ | |

Sample order VCARE BENCH 1U TB1 (E-BL CC-KG TB-U0901TP AE-J1-BL J1-BS-YKU012-GE GDN IN-WS ASM-F)

③ – Please specify metal colour code – [see finishes](#)

④ – Please specify plastic colour code – [see finishes](#)

⑧ – Please specify media port standard: FR, GB, GE

- Available as standard (included in basic price)
- Available as an option (included in basic price)

V-Care bench 2U with big table



VCARE BENCH 2U TB1

W 1680 mm
D 610 mm
H 820 mm
SH 460 mm
SH DIN 420 mm
WT 36,2 kg

Basic price (EUR)

1228

| | | | | |
|--------------------------------------|---|---------------------------------------|--|------------------|
| Frame | Powder-coated steel | | E-(3) | • |
| Shell | PU foam | | CC-(4) | • |
| Big table | Laminate Traceless TP Black | | TB-U0901TP | • |
| | None | | | • |
| Armrests | 2 external armrests | Powder-coated aluminium | AE-J2-(3) | 112 |
| | 2 external armrests 2 internal armrests | Powder-coated aluminium | AI-J2-(3) AE-J2-(3) | 224 |
| | None | | | • |
| Media | 1 module | 1 × TUF double USB charger (type A+C) | J2-BS-YKU012-(8) | 478 |
| | 2 media ports | 2 modules | 1 × power socket 1 × USB charger (type C) | J2-BS-YKU013-(8) |
| | None | | | • |
| Cable outlet | Left | | BO-L | ◦ |
| | Right | | BO-R | ◦ |
| | | | | |
| | Plastic | | GD | • |
| | Plastic nonskid | | GDN | 16 |
| Glides | Floor fixing glued | | GDG | 66 |
| | Floor fixing screwed | | GDS | 46 |
| | Floor fixing magnetic | | GDMG | 156 |
| | None | | | • |
| Wall spacer | Wall spacer (available only for GD and GDN glides) | | IN-WS | 108 |
| Wood and wood-based materials | Raw material – EU timber regulation, from certified forests, FSC certificate – authorized companies | | FSCMIX | • |
| Assembly | Assembled | | ASM-F | • |
| | Unassembled | | ASM-U | ◦ |

Sample order VCARE BENCH 2U TB1 (E-BL CC-KG TB-U0901TP AI-J2-BL AE-J2-BL BO-R GD IN-WS FSCMIX ASM-F)

(3) – Please specify metal colour code – [see finishes](#)

(4) – Please specify plastic colour code – [see finishes](#)

(8) – Please specify media port standard: FR, GB, GE

• Available as standard (included in basic price)

◦ Available as an option (included in basic price)

Price list

V-Care bench 3U with big table



VCARE BENCH 3U TB1

W 2250 mm
D 610 mm
H 820 mm
SH 460 mm
SH DIN 420 mm
WT 46,4 kg

Basic price (EUR)

1584

| | | | | |
|--------------------------------------|---|--|-----------------|-----|
| Frame | Powder-coated steel | | E-③ | • |
| Shell | PU foam | | CC-④ | • |
| Big table | Laminate Traceless TP Black | | TB-U0901TP | • |
| Armrests | None | | | • |
| | 2 external armrests | Powder-coated aluminium | AE-J2-③ | 112 |
| | 2 external armrests 3 internal armrests | Powder-coated aluminium | AI-J3-③ AE-J2-③ | 280 |
| Media | None | | | • |
| | 1 module | 1× TUF double USB charger (type A+C) | J2-BS-YKU012-⑧ | 478 |
| | 2 media ports | 1× power socket 1× USB charger (type C) | J2-BS-YKU013-⑧ | 308 |
| Cable outlet | None | | | • |
| | Left | | BO-L | ◦ |
| | Right | | BO-R | ◦ |
| Glides | Plastic | | GD | • |
| | Plastic nonskid | | GDN | 16 |
| | Floor fixing glued | | GDG | 66 |
| | Floor fixing screwed | | GDS | 46 |
| | Floor fixing magnetic | | GDMG | 156 |
| Wall spacer | None | | | • |
| | Wall spacer (available only for GD and GDN glides) | | IN-WS | 108 |
| Wood and wood-based materials | Raw material – EU timber regulation, from certified forests, FSC certificate – authorized companies | | FSCMIX | • |
| Assembly | Assembled | | ASM-F | • |
| | Unassembled | | ASM-U | ◦ |

Sample order VCARE BENCH 3U TB1 (E-BL CC-KG TB-U0901TP AI-J3-BL AE-J2-BL BO-R GD IN-WS FSCMIX ASM-F)

③ – Please specify metal colour code – [see finishes](#)

④ – Please specify plastic colour code – [see finishes](#)

⑧ – Please specify media port standard: FR, GB, GE

• Available as standard (included in basic price)

◦ Available as an option (included in basic price)

V-Care bench 4U with big table



VCARE BENCH 4U TB1

W 2250 mm
D 610 mm
H 820 mm
SH 460 mm
SH DIN 420 mm
WT 46,4 kg

Basic price (EUR)

1940

| | | | | | |
|--------------------------------------|---|--|--|----------------------|-----|
| Frame | Powder-coated steel | | E-(3) | • | |
| Shell | PU foam | | CC-(4) | • | |
| Big table | Compact Laminat U0901TP Traceless Black | | TB-U0901TP | • | |
| | None | | | • | |
| Armrests | 2 external armrests | Powder-coated aluminium | AE-J2-(3) | 112 | |
| | 2 external armrests 4 internal armrests | Powder-coated aluminium | AI-J4-(3) AE-J2-(3) | 336 | |
| | None | | | • | |
| Media | 1 module | 1 × TUF double USB charger (type A+C) | J2-BS- YKU012-(8) | 478 | |
| | 2 media ports | 2 modules | 1 × power socket 1 × USB charger (type C) | J2-BS- YKU013-(8) | 308 |
| | None | | | • | |
| Cable outlet | Left | | BO-L | ◦ | |
| | Right | | BO-R | ◦ | |
| | None | | | • | |
| Glides | Plastic | | GD | • | |
| | Plastic nonskid | | GDN | 16 | |
| | Floor fixing glued | | GDG | 66 | |
| | Floor fixing screwed | | GDS | 46 | |
| | Floor fixing magnetic | | GDMG | 156 | |
| Wall spacer | None | | | • | |
| | Wall spacer (available only for GD and GDN glides) | | IN-WS | 108 | |
| Wood and wood-based materials | Raw material – EU timber regulation, from certified forests, FSC certificate – authorized companies | | FSCMIX | • | |
| Assembly | Assembled | | ASM-F | • | |
| | Unassembled | | ASM-U | ◦ | |

Sample order VCARE BENCH 4U TB1 (E-BL CC-KG TB-U0901TP AI-J4-BL AE-J2-BL BO-R GD IN-WS FSCMIX ASM-F)

(3) – Please specify metal colour code – [see finishes](#)

(4) – Please specify plastic colour code – [see finishes](#)

(8) – Please specify media port standard: FR, GB, GE

• Available as standard (included in basic price)

◦ Available as an option (included in basic price)

Price list

V-Care bench PRM 2U



VCARE BENCH PRM 2U

W 1110 mm
D 610 mm
H 820 mm
SH 460 mm
SH DIN 420 mm
WT 28,6 kg

Basic price (EUR)

1062

| | | | | | | |
|---------------------|--|-------------------------|---|--------------------|-----|-----|
| Frame | Powder-coated steel | | E- ^③ | • | | |
| PRM shell | Position A | | PRM-A- ^④ | • | — | |
| | Position B | PU foam | PRM-B- ^④ | ○ | | |
| | Position A and B | | PRM-AB- ^④ | — | 33 | |
| Shell | None | | | — | • | |
| | PU foam | | CC- ^④ | • | — | |
| Armrests | None | | | | • | |
| | 2 external armrests | Powder-coated aluminium | AE-J2- ^③ | | 112 | |
| | 2 external armrests 1 internal armrest | Powder-coated aluminium | AI-J1- ^③ AE- J2- ^③ | | 168 | |
| Media | None | | | | • | |
| | 1 media port | 1 module | 1× TUF double USB charger (type A+C) | J1-BS-YKU012- ⑧ | | 365 |
| | | 2 modules | 1× power socket 1× USB charger (type C) | J1-BS-YKU013- ⑧ | | 179 |
| Cable outlet | None | | | | • | |
| | Left | | BO-L | | ○ | |
| | Right | | BO-R | | | |
| Glides | Plastic | | GD | | • | |
| | Plastic nonskid | | GDN | | 16 | |
| | Floor fixing glued | | GDG | | 66 | |
| | Floor fixing screwed | | GDS | | 46 | |
| | Floor fixing magnetic | | GDMG | | 156 | |
| Wall spacer | None | | | | • | |
| | Wall spacer (available only for GD and GDN glides) | | IN-WS | | 108 | |
| Assembly | Assembled | | ASM-F | | • | |
| | Unassembled | | ASM-U | | ○ | |

Sample order VCARE BENCH PRM 2U (E-AB-BL PRM-A-KG CC-KG TE-LR-U0901TP AE-J2-AB-BL J1-BS-YKU012-GE BO-L GD IN-WS ASM-F)

③ – Please specify metal colour code – [see finishes](#)

④ – Please specify plastic colour code – [see finishes](#)

⑧ – Please specify media port standard: FR, GB, GE

• Available as standard (included in basic price)

○ Available as an option (included in basic price)

V-Care bench PRM 3U

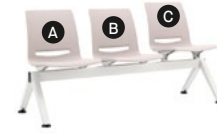

VCARE BENCH PRM 3U

W 1680 mm
D 610 mm
H 820 mm
SH 460 mm
SH DIN 420 mm
WT 38,8 kg

Basic price (EUR)

1418

| | | | | | | |
|---------------------|--|-------------------------|--|------------------|-----|-----|
| Frame | Powder-coated steel | | E-(3) | | • | |
| PRM shell | Position A | PU foam | PRM-A-(4) | • | — | — |
| | Position C | | PRM-C-(4) | ○ | — | — |
| | Position A and C | | PRM-AC-(4) | — | 33 | — |
| | Position A, B and C | | PRM-ABC-(4) | — | — | 66 |
| Shell | None | | | — | • | |
| | PU foam | | CC-(4) | • | — | |
| Armrests | None | | | | • | |
| | 2 external armrests | Powder-coated aluminium | AE-J2-(3) | | 112 | |
| | 2 external armrests 2 internal armrests | Powder-coated aluminium | AI-J2-(3) AE-J2-(3) | | 224 | |
| Media | None | | | | • | |
| | 2 media ports | 1 module | 1 × TUF double USB charger (type A+C) | J2-BS-YKU012-(8) | | 478 |
| | | 2 modules | 1 × power socket 1 × USB charger (type C) | J2-BS-YKU013-(8) | | 308 |
| Cable outlet | None | | | | • | |
| | Left | | BO-L | | ○ | |
| | Right | | BO-R | | | |
| Glides | Plastic | | GD | | • | |
| | Plastic nonskid | | GDN | | 16 | |
| | Floor fixing glued | | GDG | | 66 | |
| | Floor fixing screwed | | GDS | | 46 | |
| | Floor fixing magnetic | | GDMG | | 156 | |
| Wall spacer | None | | | | • | |
| | Wall spacer (available only for GD and GDN glides) | | IN-WS | | 108 | |
| Assembly | Assembled | | ASM-F | | • | |
| | Unassembled | | ASM-U | | ○ | |

Sample order VCARE BENCH PRM 3U (E-AB-BL PRM-A-KG CC-KG AE-J2-AB-BL BO-L GD IN-WS ASM-F)

(3) – Please specify metal colour code – [see finishes](#)

(4) – Please specify plastic colour code – [see finishes](#)

(8) – Please specify media port standard: FR, GB, GE

• Available as standard (included in basic price)

○ Available as an option (included in basic price)

Price list

V-Care bench PRM 4U

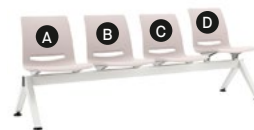

VCARE BENCH PRM 4U

W 2250 mm
D 610 mm
H 820 mm
SH 460 mm
SH DIN 420 mm
WT 49,0 kg

Basic price (EUR)

1774

| | | | | | |
|---------------------|--|---|---|---|-----|
| Frame | Powder-coated steel | | E- ^③ | • | |
| PRM shell | Position A | PU foam | PRM-A- ^④ | • | — |
| | Position D | | PRM-D- ^④ | ◦ | — |
| | Position A and D | | PRM-AD- ^④ | — | 33 |
| | Position A, B, C and D | | PRM-ABCD- ^④ | — | 99 |
| Shell | None | | | — | • |
| | PU foam | | CC- ^④ | • | — |
| Armrests | None | | | • | |
| | 2 external armrests | Powder-coated aluminium | AE-J2- ^③ | | 112 |
| | 2 external armrests 3 internal armrests | Powder-coated aluminium | AI-J3- ^③ AE- J2- ^③ | | 280 |
| Media | None | | | • | |
| | 2 media ports | 1 module 1× TUF double USB charger (type A+C) | J2-BS-YKU012- ^⑧ | | 478 |
| | 2 modules | 1× power socket 1× USB charger (type C) | J2-BS-YKU013- ^⑧ | | 308 |
| Cable outlet | None | | | • | |
| | Left | | BO-L | | ◦ |
| | Right | | BO-R | | |
| Glides | Plastic | | GD | • | |
| | Plastic nonskid | | GDN | | 16 |
| | Floor fixing glued | | GDG | | 66 |
| | Floor fixing screwed | | GDS | | 46 |
| | Floor fixing magnetic | | GDMG | | 156 |
| Wall spacer | None | | | • | |
| | Wall spacer (available only for GD and GDN glides) | | IN-WS | | 108 |
| Assembly | Assembled | | ASM-F | • | |
| | Unassembled | | ASM-U | ◦ | |

Sample order VCARE BENCH PRM 4U (E-BL PRM-A-KG CC-KG AE-J2-BL BO-L GD IN-WS ASM-F)

^③ – Please specify metal colour code – [see finishes](#)

^④ – Please specify plastic colour code – [see finishes](#)

^⑧ – Please specify media port standard: FR, GB, GE

• Available as standard (included in basic price)

◦ Available as an option (included in basic price)

V-Care bench PRM 5U



VCARE BENCH PRM 5U

W 2820 mm
D 610 mm
H 820 mm
SH 460 mm
SH DIN 420 mm
WT 59,2 kg

Basic price (EUR)

2131

| | | | | | | |
|---------------------|---|--|------------------------|---|-----|-----|
| Frame | Powder-coated steel | | E-(3) | | • | |
| PRM shell | Position A | PU foam | PRM-A-(4) | • | — | — |
| | Position E | | PRM-E-(4) | ○ | | |
| | Position A and E | | PRM-AE-(4) | — | 33 | |
| | Position A, B, C, D and E | | PRM-ABCDE-(4) | | — | 132 |
| Shell | None | | | — | • | |
| | PU foam | | CC-(4) | • | | — |
| Armrests | None | | | | • | |
| | 2 external armrests | Powder-coated aluminium | AE-J2-(3) | | 112 | |
| | 2 external armrests 4 internal armrests | Powder-coated aluminium | AI-J4-(3) AE-J2-(3) | | 336 | |
| Media | None | | | | • | |
| | 1 module | 1 × TUF double USB charger (type A+C) | J2-BS-YKU012-(8) | | 478 | |
| | 2 media ports | 1 × power socket 1 × USB charger (type C) | J2-BS-YKU013-(8) | | 308 | |
| Cable outlet | None | | | | • | |
| | Left | | BO-L | | ○ | |
| | Right | | BO-R | | | |
| Glides | Plastic | | GD | | • | |
| | Plastic nonskid | | GDN | | 24 | |
| | Floor fixing glued | | GDG | | 66 | |
| | Floor fixing screwed | | GDS | | 46 | |
| | Floor fixing magnetic | | GDMG | | 234 | |
| Wall spacer | None | | | | • | |
| | Wall spacer (available only for GD and GDN glides) | | IN-WS | | 108 | |
| Assembly | Assembled | | ASM-F | | • | |
| | Unassembled | | ASM-U | | ○ | |
| Sample order | VCARE BENCH PRM 5U (E-BL PRM-A-KG CC-KG AE-J2-BL BO-L GD IN-WS ASM-F) | | | | | |

(3) – Please specify metal colour code – [see finishes](#)

(4) – Please specify plastic colour code – [see finishes](#)

(8) – Please specify media port standard: FR, GB, GE

• Available as standard (included in basic price)

○ Available as an option (included in basic price)

Price list

V-Care bench PRM 2U with external table



VCARE BENCH PRM 2U TE1

W 1530 mm
D 610 mm
H 820 mm
SH 460 mm
SH DIN 420 mm
WT 34,4 kg

Basic price (EUR)

1305

| | | | | | |
|-----------------------|---|-------------------------|--|----------------------------|-----|
| Frame | Powder-coated steel | | E- ^③ | • | |
| PRM shell | Position A | | PRM-A- ^④ | • | — |
| | Position B | PU foam | PRM-B- ^④ | ○ | |
| | Position A and B | | PRM-AB- ^④ | — | 33 |
| Shell | None | | | — | • |
| | PU foam | | CC- ^④ | • | — |
| External table | 1 piece | Left | Compact Laminat U0901TP | TE-L-U0901TP | • |
| | | Right | Traceless Black | TE-R-U0901TP | ○ |
| Armrests | None | | | | • |
| | 2 external armrests | Powder-coated aluminium | AE-J2- ^③ | | 112 |
| | 2 external armrests 1 internal armrest | Powder-coated aluminium | AI-J1- ^③ AE-J2- ^③ | | 168 |
| Media | None | | | | • |
| | 1 media port | 1 module | 1× TUF double USB charger (type A+C) | J1-BS-YKU012- ^⑧ | 365 |
| | | 2 modules | 1× power socket 1× USB charger (type C) | J1-BS-YKU013- ^⑧ | 179 |
| Cable outlet | None | | | | • |
| | Left | | BO-L | | ○ |
| | Right | | BO-R | | |

③ – Please specify metal colour code – [see finishes](#)

④ – Please specify plastic colour code – [see finishes](#)

⑧ – Please specify media port standard: FR, GB, GE

- Available as standard (included in basic price)
- Available as an option (included in basic price)

| | | | VCARE BENCH PRM 2U TE1 |
|--------------------------------------|---|--------|------------------------|
| Glides | Plastic | GD | • |
| | Plastic nonskid | GDN | 16 |
| | Floor fixing glued | GDG | 66 |
| | Floor fixing screwed | GDS | 46 |
| | Floor fixing magnetic | GDMG | 156 |
| Wall spacer | None | | • |
| | Wall spacer (available only for GD and GDN glides) | IN-WS | 108 |
| Wood and wood-based materials | Raw material – EU timber regulation, from certified forests, FSC certificate – authorized companies | FSCMIX | • |
| Assembly | Assembled | ASM-F | • |
| | Unassembled | ASM-U | ◦ |
| Sample order | VCARE BENCH PRM 2U TE1 (E-AB-BL PRM-A-KG CC-KG TE-LR-U0901TP AE-J2-AB-BL J1-BS-YKU012-GE BO-L GD IN-WS ASM-F) | | |

- Available as standard (included in basic price)
- Available as an option (included in basic price)

Price list

V-Care bench PRM 3U with external table



VCARE BENCH PRM 3U TE1

W 2100 mm
D 610 mm
H 820 mm
SH 460 mm
SH DIN 420 mm
WT 44,6 kg

Basic price (EUR)

1661

| | | | | | | |
|-----------------------|--|-------------------------|--|-------------------------------|-----|-----|
| Frame | Powder-coated steel | | E- ^③ | • | | |
| PRM shell | Position A | | PRM-A- ^④ | • | — | — |
| | Position B | PU foam | PRM-B- ^④ | ○ | | — |
| | Position A and B | | PRM-AB- ^④ | — | 33 | |
| Shell | None | | | — | | 66 |
| | PU foam | | CC- ^④ | — | | |
| External table | 1 piece | Left | TE-L-U0901TP | • | | — |
| | | Right | Compact Laminat U0901TP Traceless Black | TE-R- U0901TP | ○ | |
| Armrests | None | | | • | | |
| | 2 external armrests | Powder-coated aluminium | AE-J2- ^③ | | 112 | |
| | 2 external armrests 2 internal armrests | Powder-coated aluminium | AI-J2- ^③ AE-J2- ^③ | | 224 | |
| Media | None | | | • | | |
| | 1 media port | 1 module | 1× TUF double USB charger (type A+C) | J1-BS-YKU012- ^⑧ | | 478 |
| | | 2 modules | 1× power socket 1× USB charger (type C) | J1-BS-YKU013- ^⑧ | | 308 |
| Cable outlet | None | | | • | | |
| | Left | | BO-L | | | |
| | Right | | BO-R | ○ | | |

^③ – Please specify metal colour code – [see finishes](#)

^④ – Please specify plastic colour code – [see finishes](#)

^⑧ – Please specify media port standard: FR, GB, GE

• Available as standard (included in basic price)

○ Available as an option (included in basic price)

| | | | VCARE BENCH PRM 3U TE1 |
|--------------------------------------|---|--------|------------------------|
| Glides | Plastic | GD | • |
| | Plastic nonskid | GDN | 16 |
| | Floor fixing glued | GDG | 66 |
| | Floor fixing screwed | GDS | 46 |
| | Floor fixing magnetic | GDMG | 156 |
| Wall spacer | None | | • |
| | Wall spacer (available only for GD and GDN glides) | IN-WS | 108 |
| Wood and wood-based materials | Raw material – EU timber regulation, from certified forests, FSC certificate – authorized companies | FSCMIX | • |
| Assembly | Assembled | ASM-F | • |
| | Unassembled | ASM-U | ◦ |
| Sample order | VCARE BENCH PRM 3U TE1 (E-AB-BL PRM-A-KG CC-KG TE-LR-U0901TP AE-J2-AB-BL BO-L GD IN-WS ASM-F) | | |

- Available as standard (included in basic price)
- Available as an option (included in basic price)

Price list

V-Care bench PRM 4U with external table

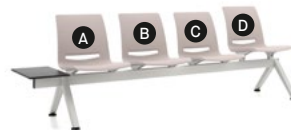

VCARE BENCH PRM 4U TE1

W 2670 mm
D 610 mm
H 820 mm
SH 460 mm
SH DIN 420 mm
WT 54,8 kg

Basic price (EUR)

2017

| | | | | | | |
|-----------------------|--|-------------------------|--|----------------------------|-----|-----|
| Frame | Powder-coated steel | | E- ^③ | • | | |
| PRM shell | Position A | | PRM-A- ^④ | • | — | — |
| | Position B | PU foam | PRM-B- ^④ | ○ | | — |
| | Position A and B | | PRM-AB- ^④ | — | 33 | |
| Shell | None | | | — | | 99 |
| | PU foam | | CC- ^④ | — | | • |
| External table | 1 piece | Left | Compact Laminat U0901TP | TE-L-U0901TP | | • |
| | | Right | Traceless Black | TE-R-U0901TP | | ○ |
| Armrests | None | | | | | • |
| | 2 external armrests | Powder-coated aluminium | AE-J2- ^③ | | 112 | |
| | 2 external armrests 3 internal armrests | Powder-coated aluminium | AI-J3- ^③ AE-J2- ^③ | | 280 | |
| Media | 1 media port | None | | | | • |
| | | 1 module | 1× TUF double USB charger (type A+C) | J1-BS-YKU012- ^⑧ | | 478 |
| | | 2 modules | 1× power socket 1× USB charger (type C) | J1-BS-YKU013- ^⑧ | | 308 |
| Cable outlet | None | | | | | • |
| | Left | | BO-L | | | ○ |
| | Right | | BO-R | | | |

③ – Please specify metal colour code – [see finishes](#)

④ – Please specify plastic colour code – [see finishes](#)

⑧ – Please specify media port standard: FR, GB, GE

• Available as standard (included in basic price)

○ Available as an option (included in basic price)

| | | | VCARE BENCH PRM 4U TE1 |
|--------------------------------------|---|--------|------------------------|
| Glides | Plastic | GD | • |
| | Plastic nonskid | GDN | 16 |
| | Floor fixing glued | GDG | 66 |
| | Floor fixing screwed | GDS | 46 |
| | Floor fixing magnetic | GDMG | 156 |
| Wall spacer | None | | • |
| | Wall spacer (available only for GD and GDN glides) | IN-WS | 108 |
| Wood and wood-based materials | Raw material – EU timber regulation, from certified forests, FSC certificate – authorized companies | FSCMIX | • |
| Assembly | Assembled | ASM-F | • |
| | Unassembled | ASM-U | ◦ |
| Sample order | VCARE BENCH PRM 4U TE1 (E-BL PRM-A-KG CC-KG TE-LR-U0901TP AE-J2-BL BO-L GD IN-WS ASM-F) | | |

- Available as standard (included in basic price)
- Available as an option (included in basic price)

Price list

V-Care bench PRM 5U with external table



VCARE BENCH PRM 5U TE1

W 3240 mm
D 610 mm
H 820 mm
SH 460 mm
SH DIN 420 mm
WT 65,0 kg

Basic price (EUR)

2374

| | | | | | | |
|-----------------------|--|-------------------------|--|----------------------------|--|-----|
| Frame | Powder-coated steel | | E- ^③ | • | | |
| PRM shell | Position A | PU foam | PRM-A- ^④ | • | | |
| | Position E | | PRM-E- ^④ | ○ | | |
| | Position A and E | | PRM-AE- ^④ | | | — |
| | Position A, B, C, D and E | | PRM-ABCDE- ^④ | — | | 33 |
| Shell | None | | | — | | 132 |
| | PU foam | | CC- ^④ | — | | • |
| External table | 1 piece | Left | Compact Laminat U0901TP | TE-L-U0901TP | | • |
| | | Right | Traceless Black | TE-R-U0901TP | | ○ |
| Armrests | None | | | | | • |
| | 2 external armrests | Powder-coated aluminium | AE-J2- ^③ | | | 112 |
| | 2 external armrests 4 internal armrests | Powder-coated aluminium | AI-J4- ^③ AE-J2- ^③ | | | 336 |
| Media | 1 media port | None | | | | • |
| | | 1 module | 1× TUF double USB charger (type A+C) | J1-BS-YKU012- ^⑧ | | 478 |
| | | 2 modules | 1× power socket 1× USB charger (type C) | J1-BS-YKU013- ^⑧ | | 308 |
| Cable outlet | None | | | | | • |
| | Left | | BO-L | | | ○ |
| | Right | | BO-R | | | ○ |

^③ – Please specify metal colour code – [see finishes](#)

^④ – Please specify plastic colour code – [see finishes](#)

^⑧ – Please specify media port standard: FR, GB, GE

• Available as standard (included in basic price)

○ Available as an option (included in basic price)

| | | | VCARE BENCH PRM 5U TE1 |
|--------------------------------------|---|--------|------------------------|
| Glides | Plastic | GD | • |
| | Plastic nonskid | GDN | 24 |
| | Floor fixing glued | GDG | 66 |
| | Floor fixing screwed | GDS | 46 |
| | Floor fixing magnetic | GDMG | 234 |
| Wall spacer | None | | • |
| | Wall spacer (available only for GD and GDN glides) | IN-WS | 108 |
| Wood and wood-based materials | Raw material – EU timber regulation, from certified forests, FSC certificate – authorized companies | FSCMIX | • |
| Assembly | Assembled | ASM-F | • |
| | Unassembled | ASM-U | ◦ |

Sample order VCARE BENCH PRM 5U TE1 (E-BL PRM-A-KG CC-KG TE-LR-U0901TP AE-J2-BL BO-L GD IN-WS ASM-F)

- Available as standard (included in basic price)
- Available as an option (included in basic price)

V-Care bench PRM 2U with external tables



VCARE BENCH PRM 2U TE2

W 1730 mm
D 610 mm
H 820 mm
SH 460 mm
SH DIN 420 mm
WT 40,2 kg

Basic price (EUR)

1548

| | | | | | | |
|------------------------|---|----------------|--|---|---|-----|
| Frame | Powder-coated steel | | | E- ^③ | • | |
| PRM shell | Position A | | | PRM-A- ^④ | • | |
| | Position B | PU foam | | PRM-B- ^④ | ○ | |
| | Position A and B | | | PRM-AB- ^④ | — | 33 |
| Shell | None | | | | — | • |
| | PU foam | | | CC- ^④ | • | — |
| External tables | 2 pieces | Left and right | Laminate Traceless TP Black | TE-LR-U0901TP | | • |
| Armrests | None | | | | | • |
| | 2 external armrests | | Powder-coated aluminium | AE-J2- ^③ | | 112 |
| | 2 external armrests 1 internal armrest | | Powder-coated aluminium | AI-J1- ^③ AE-J2- ^③ | | 168 |
| Media | None | | | | | • |
| | 1 media port | 1 module | 1× TUF double USB charger (type A+C) | J1-BS-YKU012- ^⑧ | | 365 |
| | | 2 modules | 1× power socket 1× USB charger (type C) | J1-BS-YKU013- ^⑧ | | 179 |
| Cable outlet | None | | | | | • |
| | Left | | | BO-L | | ○ |
| | Right | | | BO-R | | |

^③ – Please specify metal colour code – [see finishes](#)

^④ – Please specify plastic colour code – [see finishes](#)

^⑧ – Please specify media port standard: FR, GB, CE

• Available as standard (included in basic price)

○ Available as an option (included in basic price)

Price list

| | | | VCARE BENCH PRM 2U TE2 |
|--------------------------------------|--|--------|------------------------|
| Glides | Plastic | GD | • |
| | Plastic nonskid | GDN | 16 |
| | Floor fixing glued | GDG | 66 |
| | Floor fixing screwed | GDS | 46 |
| | Floor fixing magnetic | GDMG | 156 |
| Wall spacer | None | | • |
| | Wall spacer (available only for GD and GDN glides) | IN-WS | 108 |
| Wood and wood-based materials | Raw material – EU timber regulation, from certified forests, FSC certificate – authorized companies | FSCMIX | • |
| Assembly | Assembled | ASM-F | • |
| | Unassembled | ASM-U | o |
| Sample order | VCARE BENCH PRM 2U TE2 (E-BL PEM-B-KG CC-KG TE-LR-U0901TP AE-J2-BL J1-BS-YKU012-GE GDS FSCMIX ASM-F) | | |

- Available as standard (included in basic price)
- o Available as an option (included in basic price)

Price list

V-Care bench PRM 3U with external tables



VCARE BENCH PRM 3U TE2

W 2300 mm
D 610 mm
H 820 mm
SH 460 mm
SH DIN 420 mm
WT 50,4 kg

Basic price (EUR)

1904

| | | | | | | | |
|------------------------|--|----------------|--|---|---|-----|----|
| Frame | Powder-coated steel | | | E- ^③ | • | | |
| PRM shell | Position A | PU foam | | PRM-A- ^④ | • | — | — |
| | Position C | | | PRM-C- ^④ | ◦ | — | — |
| | Position A and C | | | PRM-AC- ^④ | — | 33 | — |
| | Position A, B and C | | | PRM-ABC- ^④ | — | — | 66 |
| Shell | None | | | | — | • | |
| | PU foam | | | CC- ^④ | • | — | — |
| External tables | 2 pieces | Left and right | Laminate Traceless TP Black | TE-LR-U0901TP | | • | |
| Armrests | None | | | | | • | |
| | 2 external armrests | | Powder-coated aluminium | AE-J2- ^③ | | 112 | |
| | 2 external armrests 2 internal armrests | | Powder-coated aluminium | AI-J2- ^③ AE-J2- ^③ | | 224 | |
| Media | None | | | | | • | |
| | 2 media ports | 1 module | 1× TUF double USB charger (type A+C) | J2-BS-YKU012- ^⑧ | | 478 | |
| | | 2 modules | 1× power socket 1× USB charger (type C) | J2-BS-YKU013- ^⑧ | | 308 | |
| Cable outlet | None | | | | | • | |
| | Left | | | BO-L | | ◦ | |
| | Right | | | BO-R | | | |

③ – Please specify metal colour code – [see finishes](#)

④ – Please specify plastic colour code – [see finishes](#)

⑧ – Please specify media port standard: FR, GB, GE

• Available as standard (included in basic price)

◦ Available as an option (included in basic price)

| | | | VCARE BENCH PRM 3U TE2 |
|--------------------------------------|---|--------|------------------------|
| Glides | Plastic | GD | • |
| | Plastic nonskid | GDN | 16 |
| | Floor fixing glued | GDG | 66 |
| | Floor fixing screwed | GDS | 46 |
| | Floor fixing magnetic | GDMG | 156 |
| Wall spacer | None | | • |
| | Wall spacer (available only for GD and GDN glides) | IN-WS | 108 |
| Wood and wood-based materials | Raw material – EU timber regulation, from certified forests, FSC certificate – authorized companies | FSCMIX | • |
| Assembly | Assembled | ASM-F | • |
| | Unassembled | ASM-U | ◦ |
| Sample order | VCARE BENCH PRM 3U TE2 (E-BL PRM-AC-KG CC-KG TE-LR-U0901TP AE-J2-BL J2-BS-YKU012-GE GDN FSCMIX ASM-F) | | |

- Available as standard (included in basic price)
- Available as an option (included in basic price)

Price list

V-Care bench PRM 4U with external tables



VCARE BENCH PRM 4U TE2

W 2870 mm
D 610 mm
H 820 mm
SH 460 mm
SH DIN 420 mm
WT 60,6 kg

Basic price (EUR)

2260

| | | | | | | |
|------------------------|--|----------------|--|---|---|-----|
| Frame | Powder-coated steel | | | E- ^③ | • | |
| PRM shell | Position A | | | PRM-A- ^④ | • | — |
| | Position D | | | PRM-D- ^④ | ◦ | — |
| | Position A and D | | PU foam | PRM-AD- ^④ | — | 33 |
| | Position A, B, C and D | | | PRM-ABCD- ^④ | — | 99 |
| Shell | None | | | | — | • |
| | PU foam | | | CC- ^④ | • | — |
| External tables | 2 pieces | Left and right | Laminate Traceless TP Black | TE-LR-U0901TP | | • |
| Armrests | None | | | | | • |
| | 2 external armrests | | Powder-coated aluminium | AE-J2- ^③ | | 112 |
| | 2 external armrests 3 internal armrests | | Powder-coated aluminium | AI-J3- ^③ AE-J2- ^③ | | 280 |
| Media | None | | | | | • |
| | 2 media ports | 1 module | 1× TUF double USB charger (type A+C) | J2-BS-YKU012- ^⑧ | | 478 |
| | | 2 modules | 1× power socket 1× USB charger (type C) | J2-BS-YKU013- ^⑧ | | 308 |
| Cable outlet | None | | | | | • |
| | Left | | | BO-L | | ◦ |
| | Right | | | BO-R | | ◦ |

^③ – Please specify metal colour code – [see finishes](#)

^④ – Please specify plastic colour code – [see finishes](#)

^⑧ – Please specify media port standard: FR, GB, GE

- Available as standard (included in basic price)
- Available as an option (included in basic price)

| | | | VCARE BENCH PRM 4U TE2 |
|--------------------------------------|---|--------|------------------------|
| Glides | Plastic | GD | • |
| | Plastic nonskid | GDN | 16 |
| | Floor fixing glued | GDG | 66 |
| | Floor fixing screwed | GDS | 46 |
| | Floor fixing magnetic | GDMG | 156 |
| Wall spacer | None | | • |
| | Wall spacer (available only for GD and GDN glides) | IN-WS | 108 |
| Wood and wood-based materials | Raw material – EU timber regulation, from certified forests, FSC certificate – authorized companies | FSCMIX | • |
| Assembly | Assembled | ASM-F | • |
| | Unassembled | ASM-U | ◦ |
| Sample order | VCARE BENCH PRM 4U TE2 (E-AB-BL PRM-AC-KG CC-KG TE-LR-U0901TP AI-J3-AB-BL AE-J2-AB-BL J2-BS-YKU012-GE GDN FSCMIX ASM-F) | | |

- Available as standard (included in basic price)
- Available as an option (included in basic price)

Price list

V-Care bench PRM 5U with external tables



VCARE BENCH PRM 5U TE2

W 3440 mm
D 610 mm
H 820 mm
SH 460 mm
SH DIN 420 mm
WT 70,8 kg

Basic price (EUR)

2617

| | | | | | | |
|------------------------|--|-------------------------|--|--|---|-----|
| Frame | Powder-coated steel | | | E- ^③ | • | |
| PRM shell | Position A | | PU foam | PRM-A- ^④ | • | — |
| | Position E | | | PRM-E- ^④ | ◦ | — |
| | Position A and E | | | PRM-AE- ^④ | — | 33 |
| | Position A, B, C, D and E | | | PRM-ABCDE- ^④ | — | 132 |
| Shell | None | | | | — | • |
| | PU foam | | | CC- ^④ | • | — |
| External tables | 2 pieces | Left and right | Compact Laminat U0901TP Traceless Black | TE-LR- U0901TP | | • |
| Armrests | None | | | | | • |
| | 2 external armrests | Powder-coated aluminium | | AE-J2- ^③ | | 112 |
| | 2 external armrests 4 internal armrests | Powder-coated aluminium | | AI-J4- ^③ AE-J2- ^③ | | 336 |
| Media | None | | | | | • |
| | 2 media ports | 1 module | 1× TUF double USB charger (type A+C) | J2-BS- YKU012- ^⑧ | | 478 |
| | | 2 modules | 1× power socket 1× USB charger (type C) | J2-BS- YKU013- ^⑧ | | 308 |
| Cable outlet | None | | | | | • |
| | Left | | | BO-L | | ◦ |
| | Right | | | BO-R | | |

^③ – Please specify metal colour code – [see finishes](#)

^④ – Please specify plastic colour code – [see finishes](#)

^⑧ – Please specify media port standard: FR, GB, GE

- Available as standard (included in basic price)
- Available as an option (included in basic price)

| | | | VCARE BENCH PRM 5U TE2 |
|--------------------------------------|---|--------|------------------------|
| Glides | Plastic | GD | • |
| | Plastic nonskid | GDN | 24 |
| | Floor fixing glued | GDG | 66 |
| | Floor fixing screwed | GDS | 46 |
| | Floor fixing magnetic | GDMG | 234 |
| Wall spacer | None | | • |
| | Wall spacer (available only for GD and GDN glides) | IN-WS | 108 |
| Wood and wood-based materials | Raw material – EU timber regulation, from certified forests, FSC certificate – authorized companies | FSCMIX | • |
| Assembly | Assembled | ASM-F | • |
| | Unassembled | ASM-U | ◦ |
| Sample order | VCARE BENCH PRM 5U TE2 (E-AB-BL PRM-AC-KG CC-KG TE-LR-U0901TP AI-J4-AB-BL AE-J2-AB-BL J2-BS-YKU012-GE GDN FSCMIX ASM-F) | | |

- Available as standard (included in basic price)
- Available as an option (included in basic price)

Price list

V-Care bench PRM 1U with big table



VCARE BENCH PRM 1U TB1

W 1110 mm
D 610 mm
H 820 mm
SH 460 mm
SH DIN 420 mm
WT 26,6 kg

Basic price (EUR)

904

| | | | | | |
|--------------------------------------|---|-------------------------|--|----------------|-----|
| Frame | Powder-coated steel | | E-③ | • | |
| PRM shell | Position A | PU foam | PRM-A-④ | • | |
| Big table | Laminate Traceless TP Black | | TB-U0901TP | • | |
| Armrests | None | | | • | |
| | 1 external armrest | Powder-coated aluminium | AE-J1-③ | 56 | |
| | 1 external armrest 1 internal armrest | Powder-coated aluminium | AI-J1-③ AE-J1-③ | 112 | |
| Media | None | | | • | |
| | 1 media port | 1 module | 1× TUF double USB charger (type A+C) | J1-BS-YKU012-⑧ | 365 |
| | | 2 modules | 1× power socket 1× USB charger (type C) | J1-BS-YKU013-⑧ | 179 |
| Cable outlet | None | | | • | |
| | Left | | BO-L | ◦ | |
| | Right | | BO-R | ◦ | |
| Glides | Plastic | | GD | • | |
| | Plastic nonskid | | GDN | 16 | |
| | Floor fixing glued | | GDG | 66 | |
| | Floor fixing screwed | | GDS | 46 | |
| | Floor fixing magnetic | | GDMG | 156 | |
| Wall spacer | None | | | • | |
| | Wall spacer (available only for GD and GDN glides) | | IN-WS | 108 | |
| Wood and wood-based materials | Raw material – EU timber regulation, from certified forests, FSC certificate – authorized companies | | FSCMIX | • | |
| Assembly | Assembled | | ASM-F | • | |
| | Unassembled | | ASM-U | ◦ | |

Sample order VCARE BENCH PRM 1U TB1 (E-BL PRM-A-KG TB-U0901TP AI-J1-BL AE-J1-BL BO-R GD IN-WS FSCMIX ASM-F)

③ – Please specify metal colour code – [see finishes](#)

④ – Please specify plastic colour code – [see finishes](#)

⑧ – Please specify media port standard: FR, GB, GE

• Available as standard (included in basic price)

◦ Available as an option (included in basic price)

V-Care bench PRM 2U with big table



VCARE BENCH PRM 2U TB1

W 1680 mm
D 610 mm
H 820 mm
SH460 mm
SH DIN 420 mm
WT 36,8 kg

Basic price (EUR)

1260

| | | | | | |
|---------------------|--|-------------------------|--|------------------|-----|
| Frame | Powder-coated steel | | E-(3) | • | |
| PRM shell | Position A | | PRM-A-(4) | • | |
| | Position B | PU foam | PRM-B-(4) | ○ | |
| | Position A and B | | PRM-AB-(4) | — | 33 |
| Shell | None | | | — | • |
| | PU foam | | CC-(4) | • | — |
| Big table | Laminate Traceless TP Black | | TB-U0901TP | • | |
| Armrests | None | | | • | |
| | 2 external armrests | Powder-coated aluminium | AE-J2-(3) | | 112 |
| | 2 external armrests 2 internal armrests | Powder-coated aluminium | AI-J2-(3) AE-J2-(3) | | 224 |
| Media | None | | | • | |
| | 2 media ports | 1 module | 1 × TUF double USB charger (type A+C) | J2-BS-YKU012-(8) | 478 |
| | | 2 modules | 1 × power socket 1 × USB charger (type C) | J2-BS-YKU013-(8) | 308 |
| Cable outlet | None | | | • | |
| | Left | | BO-L | ○ | |
| | Right | | BO-R | | |

(3) – Please specify metal colour code – [see finishes](#)

(4) – Please specify plastic colour code – [see finishes](#)

(8) – Please specify media port standard: FR, GB, GE

• Available as standard (included in basic price)

○ Available as an option (included in basic price)

Price list

| | | VCARE BENCH PRM 2U TB1 | |
|--------------------------------------|---|------------------------|-----|
| Glides | Plastic | GD | • |
| | Plastic nonskid | GDN | 16 |
| | Floor fixing glued | GDG | 66 |
| | Floor fixing screwed | GDS | 46 |
| | Floor fixing magnetic | GDMG | 156 |
| Wall spacer | None | | • |
| | Wall spacer (available only for GD and GDN glides) | IN-WS | 108 |
| Wood and wood-based materials | Raw material – EU timber regulation, from certified forests, FSC certificate – authorized companies | FSCMIX | • |
| Assembly | Assembled | ASM-F | • |
| | Unassembled | ASM-U | ◦ |
| Sample order | VCARE BENCH PRM 2U TB1 (E-BL PRM-A-KG CC-KG TB-U0901TP AE-J2-BL J2-BSYKU012-GE GD IN-WS FSCMIX ASM-F) | | |

- Available as standard (included in basic price)
- Available as an option (included in basic price)

V-Care bench PRM 3U with big table



VCARE BENCH PRM 3U TB1

W 2250 mm
D 610 mm
H 820 mm
SH 460 mm
SH DIN420 mm
WT 47,0 kg

Basic price (EUR)

1616

| | | | | | | |
|---------------------|--|--|-------------------------|---|----|-----|
| Frame | Powder-coated steel | | E-(3) | | • | |
| PRM shell | Position A | PU foam | PRM-A-(4) | • | — | — |
| | Position C | | PRM-C-(4) | ◦ | | |
| | Position A and C | | PRM-AC-(4) | — | 33 | |
| | Position A, B and C | | PRM-ABC-(4) | | — | 66 |
| Shell | None | | | — | • | |
| | PU foam | | CC-(4) | • | | — |
| Big table | Laminate Traceless TP Black | | TB-U0901TP | | • | |
| | None | | | | • | |
| Armrests | 2 external armrests | Powder-coated aluminium | AE-J2-(3) | | | 112 |
| | 2 external armrests 3 internal armrests | Powder-coated aluminium | AI-J3-(3) AE- J2-(3) | | | 280 |
| | None | | | | • | |
| Media | 1 module | 1× TUF double USB charger (type A+C) | J2-BS- YKU012-(8) | | | 478 |
| | 2 media ports | | | | | |
| | 2 modules | 1× power socket 1× USB charger (type C) | J2-BS- YKU013-(8) | | | 308 |
| Cable outlet | None | | | | • | |
| | Left | | BO-L | | | |
| | Right | | BO-R | | ◦ | |

(3) – Please specify metal colour code – [see finishes](#)

(4) – Please specify plastic colour code – [see finishes](#)

(8) – Please specify media port standard: FR, GB, GE

• Available as standard (included in basic price)

◦ Available as an option (included in basic price)

Price list

| | | | VCARE BENCH PRM 3U TB1 |
|--------------------------------------|---|--------|------------------------|
| Glides | Plastic | GD | • |
| | Plastic nonskid | GDN | 16 |
| | Floor fixing glued | GDG | 66 |
| | Floor fixing screwed | GDS | 46 |
| | Floor fixing magnetic | GDMG | 156 |
| Wall spacer | None | | • |
| | Wall spacer (available only for GD and GDN glides) | IN-WS | 108 |
| Wood and wood-based materials | Raw material – EU timber regulation, from certified forests, FSC certificate – authorized companies | FSCMIX | • |
| Assembly | Assembled | ASM-F | • |
| | Unassembled | ASM-U | ◦ |
| Sample order | VCARE BENCH PRM 3U TB1 (E-BL PRM-A-KG CC-KG TB-U0901TP AE-J2-BL BO-L GDN IN-WS FSCMIX ASM-F) | | |

- Available as standard (included in basic price)
- Available as an option (included in basic price)

V-Care bench PRM 4U with big table



VCARE BENCH PRM 4U TB1

W 2250 mm
D 610 mm
H 820 mm
SH 460 mm
SH DIN 420 mm
WT 47,0 kg

Basic price (EUR)

1973

| | | | | | |
|---------------------|--|---|------------------------|---|-----|
| Frame | Powder-coated steel | | E-(3) | • | |
| PRM shell | Position A | PU foam | PRM-A-(4) | • | — |
| | Position D | | PRM-D-(4) | ◦ | — |
| | Position A and D | | PRM-AD-(4) | — | 33 |
| | Position A, B, C and D | | PRM-ABCD-(4) | — | 99 |
| Shell | None | | | — | • |
| | PU foam | | CC-(4) | • | — |
| Big table | Compact Laminat U0901TP Traceless Black | | TB-U0901TP | • | |
| Armrests | None | | | • | |
| | 2 external armrests | Powder-coated aluminium | AE-J2-(3) | | 112 |
| | 2 external armrests 4 internal armrests | Powder-coated aluminium | AI-J4-(3) AE-J2-(3) | | 336 |
| Media | None | | | • | |
| | 1 module | 1× TUF double USB charger (type A+C) | J2-BS- YKU012-(8) | | 478 |
| | 2 media ports | 2 modules 1× power socket 1× USB charger (type C) | J2-BS- YKU013-(8) | | 308 |
| Cable outlet | None | | | • | |
| | Left | | BO-L | | ◦ |
| | Right | | BO-R | | |
| Glides | Plastic | | GD | • | |
| | Plastic nonskid | | GDN | | 16 |
| | Floor fixing glued | | GDG | | 66 |
| | Floor fixing screwed | | GDS | | 46 |
| | Floor fixing magnetic | | GDMG | | 156 |

(3) – Please specify metal colour code – [see finishes](#)

(4) – Please specify plastic colour code – [see finishes](#)

(8) – Please specify media port standard: FR, GB, GE

• Available as standard (included in basic price)

◦ Available as an option (included in basic price)

Price list

| | | | VCARE BENCH PRM 4U TB1 |
|--------------------------------------|---|--------|------------------------|
| Wall spacer | None | | ● |
| | Wall spacer (available only for GD and GDN glides) | IN-WS | 108 |
| Wood and wood-based materials | Raw material – EU timber regulation, from certified forests, FSC certificate – authorized companies | FSCMIX | ● |
| Assembly | Assembled | ASM-F | ● |
| | Unassembled | ASM-U | ○ |
| Sample order | VCARE BENCH PRM 4U TB1 (E-BL PRM-A-KG CC-KG TB-U0901TP AE-J2-BL BO-L GDN IN-WS FSCMIX ASM-F) | | |

- Available as standard (included in basic price)
- Available as an option (included in basic price)

Connector for connecting benches back to back



BENCH ACCESSORY BTB 2

Basic price (EUR)

114

Price list

V-Care Fold plywood benches, assembly to wall

Backrest and seat made of beech plywood, legs and beam made of powder-coated steel, mechanism with slow seat folding function, with or without lock in open position, mounting recommended to concrete walls only with a strength class of at least C20/25 according to the PL-EN 206-1 standard.



| V-Care Fold 1-seater plywood bench, fixed to wall | V-Care Fold 2-seater plywood bench, fixed to wall | V-Care Fold 3-seater plywood bench, fixed to wall |
|---|---|--|
| VCARE BEAM SEATING 1U MW W | VCARE BEAM SEATING 2U MW W | VCARE BEAM SEATING 3U MW W |
| W 445 mm D 601 mm H 886 mm SH 444 mm WT 16,0 kg | W 945 mm D 601 mm H 886 mm SH 444 mm WT 36,0 kg | W 1445 mm D 601 mm H 886 mm SH 444 mm WT 52,0 kg |
| Basic price (EUR) | | |
| 365 | 790 | 1120 |

| | | | | | | |
|--|---|--|---------|----|-----|-----|
| Backrest finish | Beech plywood | Natural beech | BA-SKNB | • | • | • |
| | | Stained | BA-① | 5 | 10 | 15 |
| | | Laminated | | 25 | 50 | 75 |
| Seat finish | Beech plywood (in backrest colour) | Natural beech | SE-SKNB | • | • | • |
| | | Stained | SE-① | 5 | 10 | 15 |
| | | Laminated | | 10 | 20 | 30 |
| Metal element finish | Powder-coated steel | | E-③ | • | • | • |
| Seat folding mechanism | Without seat multi-lock | | ME1 | • | • | • |
| | With seat multi-lock | | ME2 | 10 | 20 | 30 |
| Wooden and wood-based materials | Raw material – EU timber regulation, from certified forests, FSC certificate – authorized companies | For models: seat and backrest made of natural beech, stained beech | FSC | • | • | • |
| | Raw material – EU Timber regulation | For models: laminated seat and backrest | EUTR | | | |
| Wooden elements lacquering | Water lacquer | | | • | • | • |
| | Water lacquer UV | Not available for laminated seat and backrest | UV | 85 | 170 | 255 |
| Assembly | Assembled | | ASM-F | • | — | — |
| | Unassembled | | ASM-U | ○ | • | • |
| Sample order | VCARE BEAM SEATING 1U MW W (BA-SKNB BA-SKNB E-BL ME1 FSC ASM-F) | | | | | |

① – Please specify wood colour code – [see finishes](#)

③ – Please specify metal colour code – [see finishes](#)

- Available as standard (included in basic price)
- Available as an option (included in basic price)

V-Care Fold plywood benches, assembly to wall

Backrest and seat made of beech plywood, legs and beam made of powder-coated steel, mechanism with slow seat folding function, with or without lock in open position, mounting recommended to concrete walls only with a strength class of at least C20/25 according to the PL-EN 206-1 standard.



| V-Care Fold 4-seater plywood bench, fixed to wall | V-Care Fold 5-seater plywood bench, fixed to wall | V-Care Fold 6-seater plywood bench, fixed to wall |
|--|--|---|
| VCARE BEAM SEATING 4U MW W | VCARE BEAM SEATING 5U MW W | VCARE BEAM SEATING 6U MW W |
| W 1945 mm D 601 mm H 886 mm SH 444 mm WT 67,0 kg | W 2445 mm D 601 mm H 886 mm SH 444 mm WT 86,0 kg | W 2945 mm D 601 mm H 886 mm SH 444 mm WT 101,0 kg |
| Basic price (EUR) | | |
| 1455 | 1840 | 2160 |

| | | | | | | |
|--|---|--|---------|-----|-----|-----|
| Backrest finish | Beech plywood | Natural beech | BA-SKNB | • | • | • |
| | | Stained | BA-① | 20 | 25 | 30 |
| | | Laminated | | 100 | 125 | 150 |
| Seat finish | Beech plywood (in backrest colour) | Natural beech | SE-SKNB | • | • | • |
| | | Stained | SE-① | 20 | 25 | 30 |
| | | Laminated | | 40 | 50 | 60 |
| Metal element finish | Powder-coated steel | | E-③ | • | • | • |
| Seat folding mechanism | Without seat multi-lock | | ME1 | • | • | • |
| | With seat multi-lock | | ME2 | 40 | 50 | 60 |
| Wooden and wood-based materials | Raw material – EU timber regulation, from certified forests, FSC certificate – authorized companies | For models: seat and backrest made of natural beech, stained beech | FSC | • | • | • |
| | Raw material – EU Timber regulation | For models: laminated seat and backrest | EUTR | | | |
| Wooden elements lacquering | Water lacquer | | | • | • | • |
| | Water lacquer UV | Not available for laminated seat and backrest | UV | 340 | 425 | 510 |
| Assembly | Unassembled | | ASM-U | • | — | — |
| Sample order | VCARE BEAM SEATING 4U MW W (BA-SKNB BA-SKNB E-BL ME1 FSC ASM-F) | | | | | |

① – Please specify wood colour code – [see finishes](#)

③ – Please specify metal colour code – [see finishes](#)

- Available as standard (included in basic price)
- Available as an option (included in basic price)

Price list

V-Care Fold plywood benches, assembly to floor

Backrest and seat made of beech plywood, legs and beam made of powder-coated steel, mechanism with slow seat folding function, with or without lock in open position.



| V-Care Fold 1-seater plywood bench, fixed to floor | V-Care Fold 2-seater plywood bench, fixed to floor | V-Care Fold 3-seater plywood bench, fixed to floor |
|---|---|--|
| VCARE BEAM SEATING 1U MF W | VCARE BEAM SEATING 2U MF W | VCARE BEAM SEATING 3U MF W |
| W 445 mm D 564 mm H 887 mm SH 445 mm WT 15,0 kg | W 945 mm D 564 mm H 887 mm SH 445 mm WT 33,0 kg | W 1445 mm D 564 mm H 887 mm SH 445 mm WT 48,0 kg |
| Basic price (EUR) | | |
| 335 | 745 | 1080 |

| | | | | | | |
|--|---|--|---------|----|-----|-----|
| Seat height | Standard | | SH1 | ● | ● | ● |
| | Higher | | SH2 | ○ | ○ | ○ |
| Backrest finish | Beech plywood | Natural beech | BA-SKNB | ● | ● | ● |
| | | Stained | BA-① | 5 | 10 | 15 |
| | | Laminated | | 25 | 50 | 75 |
| Seat finish | Beech plywood (in backrest colour) | Natural beech | SE-SKNB | ● | ● | ● |
| | | Stained | SE-① | 5 | 10 | 15 |
| | | Laminated | | 10 | 20 | 30 |
| Metal element finish | Powder-coated steel | | E-③ | ● | ● | ● |
| Seat folding mechanism | Without seat multi-lock | | ME1 | ● | ● | ● |
| | With seat multi-lock | | ME2 | 10 | 20 | 30 |
| Wooden and wood-based materials | Raw material – EU timber regulation, from certified forests, FSC certificate – authorized companies | For models: seat and backrest made of natural beech, stained beech | FSC | ● | ● | ● |
| | Raw material – EU Timber regulation | For models: laminated seat and backrest | EUTR | | | |
| Wooden elements lacquering | Water lacquer | | | ● | ● | ● |
| | Water lacquer UV | Not available for laminated seat and backrest | UV | 85 | 170 | 255 |
| Assembly | Assembled | | ASM-F | ● | — | — |
| | Unassembled | | ASM-U | ○ | ● | ● |

Sample order VCARE BEAM SEATING 1U MF W (SH1 BA-SKNB BA-SKNB E-BL ME1 FSC ASM-F)

① – Please specify wood colour code – [see finishes](#)

③ – Please specify metal colour code – [see finishes](#)

● Available as standard (included in basic price)

○ Available as an option (included in basic price)

V-Care Fold plywood benches, assembly to floor

Backrest and seat made of beech plywood, legs and beam made of powder-coated steel, mechanism with slow seat folding function, with or without lock in open position.



| V-Care Fold 4-seater plywood bench, fixed to floor | V-Care Fold 5-seater plywood bench, fixed to floor | V-Care Fold 6-seater plywood bench, fixed to floor |
|--|--|--|
| VCARE BEAM SEATING 4U MF W | VCARE BEAM SEATING 5U MF W | VCARE BEAM SEATING 6U MF W |
| W 1945 mm D 564 mm H 887 mm SH 445 mm WT 64,0 kg | W 2445 mm D 564 mm H 887 mm SH 445 mm WT 81,0 kg | W 2945 mm D 564 mm H 887 mm SH 445 mm WT 96,0 kg |
| Basic price (EUR) | | |
| 1405 | 1785 | 2110 |

| | | | | | | |
|--|---|--|---------|-----|-----|-----|
| Seat height | Standard | | SH1 | ● | ● | ● |
| | Higher | | SH2 | ○ | ○ | ○ |
| Backrest finish | Beech plywood | Natural beech | BA-SKNB | ● | ● | ● |
| | | Stained | BA-① | 20 | 25 | 30 |
| | | Laminated | | 100 | 125 | 150 |
| Seat finish | Beech plywood (in backrest colour) | Natural beech | SE-SKNB | ● | ● | ● |
| | | Stained | SE-① | 20 | 25 | 30 |
| | | Laminated | | 40 | 50 | 60 |
| Metal element finish | Powder-coated steel | | E-③ | ● | ● | ● |
| Seat folding mechanism | Without seat multi-lock | | ME1 | ● | ● | ● |
| | With seat multi-lock | | ME2 | 40 | 50 | 60 |
| Wooden and wood-based materials | Raw material – EU timber regulation, from certified forests, FSC certificate – authorized companies | For models: seat and backrest made of natural beech, stained beech | FSC | ● | ● | ● |
| | Raw material – EU Timber regulation | For models: laminated seat and backrest | EUTR | | | |
| Wooden elements lacquering | Water lacquer | | | ● | ● | ● |
| | Water lacquer UV | Not available for laminated seat and backrest | UV | 340 | 425 | 510 |
| Assembly | Assembled | | ASM-F | ● | — | — |
| | Unassembled | | ASM-U | ○ | ● | ● |
| Sample order | VCARE BEAM SEATING 4U MF W (SH1 BA-SKNB BA-SKNB E-BL ME1 FSC ASM-F) | | | | | |

① – Please specify wood colour code – [see finishes](#)

③ – Please specify metal colour code – [see finishes](#)

● Available as standard (included in basic price)

○ Available as an option (included in basic price)

Price list

V-Care Fold plywood benches, freestanding

Backrest and seat made of beech plywood, legs and beam made of powder-coated steel, mechanism with slow seat folding function, with or without lock in open position, plastic glides.



| V-Care Fold 2-seater plywood bench, freestanding | V-Care Fold 3-seater plywood bench, freestanding | V-Care Fold 4-seater plywood bench, freestanding |
|---|--|--|
| VCARE BEAM SEATING 2U FS W | VCARE BEAM SEATING 3U FS W | VCARE BEAM SEATING 4U FS W |
| W 945 mm D 564 mm H 886 mm SH 444 mm WT 35,0 kg | W 1445 mm D 564 mm H 886 mm SH 444 mm WT 51,0 kg | W 1945 mm D 564 mm H 886 mm SH 444 mm WT 66,0 kg |
| Basic price (EUR) | | |
| 780 | 1110 | 1440 |

| | | | | | | |
|--|---|--|---------|-----|-----|-----|
| Seat height | Standard | | SH1 | ● | ● | ● |
| | Higher | | SH2 | ○ | ○ | ○ |
| Backrest finish | Beech plywood | Natural beech | BA-SKNB | ● | ● | ● |
| | | Stained | BA-① | 10 | 15 | 20 |
| | | Laminated | | 50 | 75 | 100 |
| Seat finish | Beech plywood (in backrest colour) | Natural beech | SE-SKNB | ● | ● | ● |
| | | Stained | SE-① | 10 | 15 | 20 |
| | | Laminated | | 20 | 30 | 40 |
| Metal element finish | Powder-coated steel | | E-③ | ● | ● | ● |
| Seat folding mechanism | Without seat multi-lock | | ME1 | ● | ● | ● |
| | With seat multi-lock | | ME2 | 20 | 30 | 40 |
| Wooden and wood-based materials | Raw material – EU timber regulation, from certified forests, FSC certificate – authorized companies | For models: seat and backrest made of natural beech, stained beech | FSC | ● | ● | ● |
| | Raw material – EU Timber regulation | For models: laminated seat and backrest | EUTR | | | |
| Wooden elements lacquering | Water lacquer | | | ● | ● | ● |
| | Water lacquer UV | Not available for laminated seat and backrest | UV | 170 | 255 | 340 |
| Assembly | Assembled | | ASM-F | ● | — | — |
| | Unassembled | | ASM-U | ○ | ● | ● |

Sample order VCARE BEAM SEATING 2U FS W (SH1 BA-SKNB BA-SKNB E-BL ME1 FSC ASM-F)

① – Please specify wood colour code – [see finishes](#)

③ – Please specify metal colour code – [see finishes](#)

● Available as standard (included in basic price)

○ Available as an option (included in basic price)

V-Care Fold plywood benches, freestanding

Backrest and seat made of beech plywood, legs and beam made of powder-coated steel, mechanism with slow seat folding function, with or without lock in open position, plastic glides.



| V-Care Fold 5-seater plywood bench, freestanding | V-Care Fold 6-seater plywood bench, freestanding |
|--|---|
| VCARE BEAM SEATING 5U FS W | VCARE BEAM SEATING 6U FS W |
| W 2445 mm D 564 mm H 886 mm SH 444 mm WT 84,0 kg | W 2945 mm D 564 mm H 886 mm SH 444 mm WT 100,0 kg |
| Basic price (EUR) | |
| 1825 | 2140 |

| | | | | | |
|--|---|--|---------|-----|-----|
| Seat height | Standard | SH1 | ● | ● | |
| | Higher | SH2 | ○ | ○ | |
| Backrest finish | Beech plywood | Natural beech | BA-SKNB | ● | ● |
| | | Stained | BA-① | 25 | 30 |
| | | Laminated | | 125 | 150 |
| Seat finish | Beech plywood (in backrest colour) | Natural beech | SE-SKNB | ● | ● |
| | | Stained | SE-① | 25 | 30 |
| | | Laminated | | 50 | 60 |
| Metal element finish | Powder-coated steel | E-③ | ● | ● | |
| Seat folding mechanism | Without seat multi-lock | ME1 | ● | ● | |
| | With seat multi-lock | ME2 | 50 | 60 | |
| Wooden and wood-based materials | Raw material – EU timber regulation, from certified forests, FSC certificate – authorized companies | For models: seat and backrest made of natural beech, stained beech | FSC | ● | ● |
| | Raw material – EU Timber regulation | For models: laminated seat and backrest | EUTR | | |
| Wooden elements lacquering | Water lacquer | | | ● | ● |
| | Water lacquer UV | Not available for laminated seat and backrest | UV | 425 | 510 |
| Assembly | Assembled | ASM-F | ● | — | |
| | Unassembled | ASM-U | ○ | ● | |

Sample order VCARE BEAM SEATING 5U FS W (SH1 BA-SKNB BA-SKNB E-BL ME1 FSC ASM-F)

① – Please specify wood colour code – [see finishes](#)

③ – Please specify metal colour code – [see finishes](#)

- Available as standard (included in basic price)
- Available as an option (included in basic price)

Price list

V-Care Fold upholstered benches, assembly to wall

Upholstered backrest and seat, legs and beam made of powder-coated steel, mechanism with slow seat folding function, with or without lock in open position, mounting recommended to concrete walls only with a strength class of at least C20/25 according to the PL-EN 206-1 standard.



| V-Care Fold 1-seater upholstered bench, fixed to wall | V-Care Fold 2-seater upholstered bench, fixed to wall | V-Care Fold 3-seater upholstered bench, fixed to wall |
|---|---|--|
| VCARE BEAM SEATING 1U MW UPH | VCARE BEAM SEATING 2U MW UPH | VCARE BEAM SEATING 3U MW UPH |
| W 465 mm D 611 mm H 901 mm SH 458 mm WT 17,0 kg | W 965 mm D 611 mm H 901 mm SH 458 mm WT 38,0 kg | W 1465 mm D 611 mm H 901 mm SH 458 mm WT 55,0 kg |

Basic price (EUR) according to upholstery price group

| | 1U MW UPH | 2U MW UPH | 3U MW UPH |
|---------------|-----------|-----------|-----------|
| Price group 2 | 415 | 895 | 1280 |
| Price group 3 | 445 | 950 | 1360 |
| Price group 4 | 465 | 995 | 1430 |
| Price group 6 | 635 | 1330 | 1930 |

| | | | | | |
|--|---|-------|----|----|----|
| Backrest finish | Upholstery | BA-⑤ | • | • | • |
| Seat finish | Upholstery (in backrest colour) | SE-⑤ | • | • | • |
| Metal element finish | Powder-coated steel | E-③ | • | • | • |
| Seat folding mechanism | Without seat multi-lock | ME1 | • | • | • |
| | With seat multi-lock | ME2 | 10 | 20 | 30 |
| Foam | Flame retardant | FFR2 | • | • | • |
| Wooden and wood-based materials | Raw material – EU timber regulation, from certified forests, FSC certificate – authorized companies | FSC | • | • | • |
| Assembly | Assembled | ASM-F | • | — | — |
| | Unassembled | ASM-U | ○ | • | • |

Sample order VCARE BEAM SEATING 1U MW UPH (BA-VL9035 SE-VL9035 E-BL ME1 FFR2 FSC ASM-F)

③ – Please specify metal colour code – [see finishes](#)

⑤ – Please specify upholstery colour code from selected price group – [see finishes](#)

- Available as standard (included in basic price)
- Available as an option (included in basic price)

V-Care Fold upholstered benches, assembly to wall

Upholstered backrest and seat, legs and beam made of powder-coated steel, mechanism with slow seat folding function, with or without lock in open position, mounting recommended to concrete walls only with a strength class of at least C20/25 according to the PL-EN 206-1 standard.



| V-Care Fold 4-seater upholstered bench, fixed to wall | V-Care Fold 5-seater upholstered bench, fixed to wall | V-Care Fold 6-seater upholstered bench, fixed to wall |
|--|--|---|
| VCARE BEAM SEATING 4U MW UPH | VCARE BEAM SEATING 5U MW UPH | VCARE BEAM SEATING 6U MW UPH |
| W 1965 mm D 611 mm H 901 mm SH 458 mm WT 72,0 kg | W 2465 mm D 611 mm H 901 mm SH 458 mm WT 91,0 kg | W 2946 mm D 611 mm H 901 mm SH 458 mm WT 108,0 kg |

Basic price (EUR) according to upholstery price group

| | 4U MW UPH | 5U MW UPH | 6U MW UPH |
|---------------|-----------|-----------|-----------|
| Price group 2 | 1655 | 2100 | 2475 |
| Price group 3 | 1765 | 2235 | 2635 |
| Price group 4 | 1860 | 2360 | 2780 |
| Price group 6 | 2520 | 3185 | 3775 |

| | | | | | |
|--|---|-------|----|----|----|
| Backrest finish | Upholstery | BA-⑤ | • | • | • |
| Seat finish | Upholstery (in backrest colour) | SE-⑤ | • | • | • |
| Metal element finish | Powder-coated steel | E-③ | • | • | • |
| Seat folding mechanism | Without seat multi-lock | ME1 | • | • | • |
| | With seat multi-lock | ME2 | 40 | 50 | 60 |
| Foam | Flame retardant | FFR2 | • | • | • |
| Wooden and wood-based materials | Raw material – EU timber regulation, from certified forests, FSC certificate – authorized companies | FSC | • | • | • |
| Assembly | Unassembled | ASM-U | • | — | — |

Sample order VCARE BEAM SEATING 4U MW UPH (BA-VL9035 SE-VL9035 E-BL ME1 FFR2 FSC ASM-F)

③ – Please specify metal colour code – [see finishes](#)

⑤ – Please specify upholstery colour code from selected price group – [see finishes](#)

- Available as standard (included in basic price)
- Available as an option (included in basic price)

Price list

V-Care Fold upholstered benches, assembly to floor

Upholstered backrest and seat, legs and beam made of powder-coated steel, mechanism with slow seat folding function, with or without lock in open position.



| V-Care Fold 1-seater upholstered bench, fixed to floor | V-Care Fold 2-seater upholstered bench, fixed to floor | V-Care Fold 3-seater upholstered bench, fixed to floor |
|--|--|--|
| VCARE BEAM SEATING 1U MF UPH | VCARE BEAM SEATING 2U MF UPH | VCARE BEAM SEATING 3U MF UPH |
| W 465 mm D 584 mm H 902 mm SH 459 mm WT 16,0 kg | W 965 mm D 584 mm H 902 mm SH 459 mm WT 35,0 kg | W 1465 mm D 584 mm H 902 mm SH 459 mm WT 51,0 kg |

Basic price (EUR) according to upholstery price group

| | 410 | 910 | 1305 |
|---------------|-----|------|------|
| Price group 2 | | | |
| Price group 3 | 435 | 965 | 1385 |
| Price group 4 | 460 | 1010 | 1450 |
| Price group 6 | 630 | 1345 | 1955 |

| | | | | | |
|--|---|-------|----|----|----|
| Seat height | Standard | SH1 | • | • | • |
| | Higher | SH2 | ○ | ○ | ○ |
| Backrest finish | Upholstery | BA-⑤ | • | • | • |
| Seat finish | Upholstery (in backrest colour) | SE-⑤ | • | • | • |
| Metal element finish | Powder-coated steel | E-③ | • | • | • |
| Seat folding mechanism | Without seat multi-lock | ME1 | • | • | • |
| | With seat multi-lock | ME2 | 10 | 20 | 30 |
| Foam | Flame retardant | FFR2 | • | • | • |
| Wooden and wood-based materials | Raw material – EU timber regulation, from certified forests, FSC certificate – authorized companies | FSC | • | • | • |
| Assembly | Assembled | ASM-F | • | — | — |
| | Unassembled | ASM-U | ○ | • | • |

Sample order VCARE BEAM SEATING1U MF UPH (SH1 BA-VL9035 SE-VL9035 E-BL ME1 FFR2 FSC ASM-F)

③ – Please specify metal colour code – [see finishes](#)

⑤ – Please specify upholstery colour code from selected price group – [see finishes](#)

• Available as standard (included in basic price)

○ Available as an option (included in basic price)

PRICE GROUP 2: Valencia

PRICE GROUP 3: Silvertex

PRICE GROUP 4: Blazer, Main Line Flax, skai Parotega, Synergy

PRICE GROUP 6: Nappa Leather

V-Care Fold upholstered benches, assembly to floor

Upholstered backrest and seat, legs and beam made of powder-coated steel, mechanism with slow seat folding function, with or without lock in open position.



| V-Care Fold 4-seater upholstered bench, fixed to floor | V-Care Fold 5-seater upholstered bench, fixed to floor | V-Care Fold 6-seater upholstered bench, fixed to floor |
|--|--|---|
| VCARE BEAM SEATING 4U MF UPH | VCARE BEAM SEATING 5U MF UPH | VCARE BEAM SEATING 6U MF UPH |
| W 1965 mm D 584 mm H 902 mm SH 459 mm WT 68,0 kg | W 2465 mm D 584 mm H 902 mm SH 459 mm WT 86,0 kg | W 2946 mm D 584 mm H 902 mm SH 459 mm WT 103,0 kg |

Basic price (EUR) according to upholstery price group

| | 4U MF UPH | 5U MF UPH | 6U MF UPH |
|---------------|-----------|-----------|-----------|
| Price group 2 | 1705 | 2165 | 2565 |
| Price group 3 | 1815 | 2300 | 2725 |
| Price group 4 | 1900 | 2410 | 2860 |
| Price group 6 | 2575 | 3245 | 3865 |

| | | | | | |
|--|---|-------|----|----|----|
| Seat height | Standard | SH1 | • | • | • |
| | Higher | SH2 | ○ | ○ | ○ |
| Backrest finish | Upholstery | BA-⑤ | • | • | • |
| Seat finish | Upholstery (in backrest colour) | SE-⑤ | • | • | • |
| Metal element finish | Powder-coated steel | E-③ | • | • | • |
| Seat folding mechanism | Without seat multi-lock | ME1 | • | • | • |
| | With seat multi-lock | ME2 | 40 | 50 | 60 |
| Foam | Flame retardant | FFR2 | • | • | • |
| Wooden and wood-based materials | Raw material – EU timber regulation, from certified forests, FSC certificate – authorized companies | FSC | • | • | • |
| Assembly | Assembled | ASM-F | • | — | — |
| | Unassembled | ASM-U | ○ | • | • |

Sample order VCARE BEAM SEATING 4U MF UPH (SH1 BA-VL9035 SE-VL9035 E-BL ME1 FFR2 FSC ASM-F)

③ – Please specify metal colour code – [see finishes](#)

⑤ – Please specify upholstery colour code from selected price group – [see finishes](#)

• Available as standard (included in basic price)

○ Available as an option (included in basic price)

PRICE GROUP 2: Valencia
 PRICE GROUP 3: Silvertex
 PRICE GROUP 4: Blazer, Main Line Flax, skai Parotega, Synergy
 PRICE GROUP 6: Nappa Leather

Price list

V-Care Fold upholstered benches, freestanding

Upholstered backrest and seat, legs and beam made of powder-coated steel, mechanism with slow seat folding function, with or without lock in open position, plastic glides



| V-Care Fold 2-seater upholstered bench, freestanding | V-Care Fold 3-seater upholstered bench, freestanding | V-Care Fold 4-seater upholstered bench, freestanding |
|---|--|--|
| VCARE BEAM SEATING 2U FS UPH | VCARE BEAM SEATING 3U FS UPH | VCARE BEAM SEATING 4U FS UPH |
| W 965 mm D 608 mm H 901 mm SH 457 mm WT 37,0 kg | W 1465 mm D 608 mm H 901 mm SH 457 mm WT 54,0 kg | W 1965 mm D 608 mm H 901 mm SH 457 mm WT 70,0 kg |

Basic price (EUR) according to upholstery price group

| | 930 | 1335 | 1750 |
|---------------|------|------|------|
| Price group 2 | | | |
| Price group 3 | 980 | 1415 | 1860 |
| Price group 4 | 1025 | 1480 | 1945 |
| Price group 6 | 1360 | 1985 | 2620 |

| | | | | | |
|--|---|-------|----|----|----|
| Seat height | Standard | SH1 | • | • | • |
| | Higher | SH2 | ○ | ○ | ○ |
| Backrest finish | Upholstery | BA-⑤ | • | • | • |
| Seat finish | Upholstery (in backrest colour) | SE-⑤ | • | • | • |
| Metal element finish | Powder-coated steel | E-③ | • | • | • |
| Seat folding mechanism | Without seat multi-lock | ME1 | • | • | • |
| | With seat multi-lock | ME2 | 20 | 30 | 40 |
| Foam | Flame retardant | FFR2 | • | • | • |
| Wooden and wood-based materials | Raw material – EU timber regulation, from certified forests, FSC certificate – authorized companies | FSC | • | • | • |
| Assembly | Assembled | ASM-F | • | — | — |
| | Unassembled | ASM-U | ○ | • | • |

Sample order VCARE BEAM SEATING2U FS UPH (SH1 BA-VL9035 SE-VL9035 E-BL ME1 FFR2 FSC ASM-F)

③ – Please specify metal colour code – [see finishes](#)

⑤ – Please specify upholstery colour code from selected price group – [see finishes](#)

- Available as standard (included in basic price)
- Available as an option (included in basic price)

PRICE GROUP 2: Valencia
 PRICE GROUP 3: Silvertex
 PRICE GROUP 4: Blazer, Main Line Flax, skai Parotega, Synergy
 PRICE GROUP 6: Nappa Leather

V-Care Fold upholstered benches, freestanding

Upholstered backrest and seat, legs and beam made of powder-coated steel, mechanism with slow seat folding function, with or without lock in open position, plastic glides



| V-Care Fold 5-seater upholstered bench, freestanding | V-Care Fold 6-seater upholstered bench, freestanding |
|--|---|
| VCARE BEAM SEATING 5U FS UPH | VCARE BEAM SEATING 6U FS UPH |
| W 2465 mm D 608 mm H 901 mm SH 457 mm WT 89,0 kg | W 2946 mm D 608 mm H 901 mm SH 457 mm WT 106,0 kg |

Basic price (EUR) according to upholstery price group

| | | |
|---------------|------|------|
| Price group 2 | 2205 | 2590 |
| Price group 3 | 2340 | 2755 |
| Price group 4 | 2450 | 2885 |
| Price group 6 | 3285 | 3890 |

| | | | | |
|--|---|-------|----|----|
| Seat height | Standard | SH1 | ● | ● |
| | Higher | SH2 | ○ | ○ |
| Backrest finish | Upholstery | BA-⑤ | ● | ● |
| Seat finish | Upholstery (in backrest colour) | SE-⑤ | ● | ● |
| Metal element finish | Powder-coated steel | E-③ | ● | ● |
| Seat folding mechanism | Without seat multi-lock | ME1 | ● | ● |
| | With seat multi-lock | ME2 | 50 | 60 |
| Foam | Flame retardant | FFR2 | ● | ● |
| Wooden and wood-based materials | Raw material – EU timber regulation, from certified forests, FSC certificate – authorized companies | FSC | ● | ● |
| Assembly | Assembled | ASM-F | ● | — |
| | Unassembled | ASM-U | ○ | ● |

Sample order VCARE BEAM SEATING 5U FS UPH (SH1 BA-VL9035 SE-VL9035 E-BL ME1 FFR2 FSC ASM-F)

③ – Please specify metal colour code – [see finishes](#)

⑤ – Please specify upholstery colour code from selected price group – [see finishes](#)

● Available as standard (included in basic price)

○ Available as an option (included in basic price)

Finishes for V-Care

Chairs

Polyurethane

for shell



KG
Black Grey

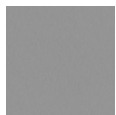

PY
Platinum Grey

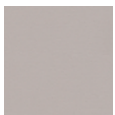

KKB
Blush Silk



PE
Purple Red

Plastic

for armrests



KB
Black



KG
Black Grey

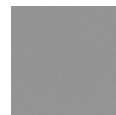

PY
Platinum Grey



KKB
Blush Silk



PE
Purple Red

Metal



NCS S 2005-Y60R
Cashmere
NK



RAL 1024
Ochre Yellow
OY



RAL 030 50 40
Vermilion Red
VR



RAL 6003
Olive Green
OG



RAL 5000
Violet Blue
VB



Chrome
CR



RAL 9006
White Aluminium
WK



DB 703
Iron Mica
IM



RAL 9005
Jet Black
BK, BL



Silk
KSK

Benches

Polyurethane

for shell



KG
Black Grey

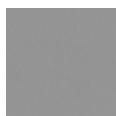

PY
Platinum Grey



KKB
Blush Silk



PE
Purple Red

Metal



RAL 9006
White Aluminium
WK



RAL 9005
Jet Black
BK, BL



Silver Aluminium
SA

Compact Laminate

for top replacing seat and tablet



U0901TP
Traceless
Black

Finishes for V-Care Fold

Wood

Natural



SKNB
Natural Beech

Stained



2.07Y
Black



2.06S
Slate



S39
Light Grey

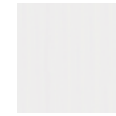

2.09S
White



2.0CB
Acacia



SK40
Oak



2.0CC
Walnut

Laminate

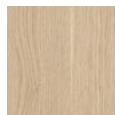

H3349
Kaisersberg
Oak



H1733
Mainau Birch

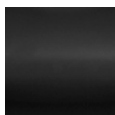

U999
Black



U963
Dark Grey



U708
Light Grey



U626
Kiwi Green



U504
Tyrolean
Blue

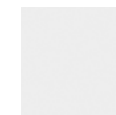

W1000
Premium
White

Metal



**NCS S
2005-Y60R**
Cashmere
NK



RAL 1024
Ochre Yellow
OY



**RAL 030 50
40**
Vermilion Red
VR



RAL 6003
Olive Green
OG



RAL 5000
Violet Blue
VB



RAL 9006
White
Aluminium
WK



DB 703
Iron Mica
IM



RAL 9005
Jet Black
BL

General notes

All specified dimensions are approximate. Subject to minor modifications or differences for reasons of design improvements or for technical reasons.

- W = width
- D = depth
- H = height
- DI = diameter
- SH = seat height
- SH DIN = seat height measured acc. to DIN EN 1335-1

In compliance with the highest quality standards "Quality is irreplaceable." Guided by this principle, each product line is subjected to stringent quality testing.

Only the products marked in this document are FSC® (FSC®-C120977). Look for our FSC®-certified products. Sale of products that meet the FSC® requirements is possible only by Nowy Styl Sp. z o.o., Nowy Styl Nederland B.V. and Kusch + Co GmbH.



The FSC® certificate applies to responsible forest management and the entire flow of raw materials from the forest to the customer. Each stage of the chain is monitored in terms of social, ecological and economic performance. The product with the FSC® label gives customers a guarantee that the wood used for the production of the product comes from sources managed in a sustainable manner.

Warranty

Manufacturer declares that the products shall be free from defects in material or workmanship. The warranty is given to the original purchaser only, for normal commercial usage. Detailed terms of warranty and warranty periods are available at <https://www.kusch.com/en/warranty>

Smile

Design: brodbeck | koepp design

Plywood chair 4L



SMILE FRAME CHAIR 4L W



SMILE FRAME CHAIR 4LA W



SMILE FRAME CHAIR 4L HB W



SMILE FRAME CHAIR 4LA HB W

Upholstered chair 4L



SMILE FRAME CHAIR 4L UPH



SMILE FRAME CHAIR 4LA UPH



SMILE FRAME CHAIR 4L HB UPH



SMILE FRAME CHAIR 4LA HB UPH

Price list

Backrest and seat made of beech plywood.
Frame: 4 powder-coated metal legs, with or without armrests, stackable,
replaceable plastic glides.



| Smile plywood chair 4L | Smile plywood chair 4L with armrests |
|--|--|
| SMILE FRAME CHAIR 4L W | SMILE FRAME CHAIR 4LA W |
| W 465 mm D 560 mm H 800 mm SH 450 mm SH DIN 415 mm WT 6,3kg | W 545 mm D 560 mm H 800 mm SH 450 mm SH DIN 415 mm WT 7,2kg |
| Basic price (EUR) | |
| 200 | 220 |

| | | | | | |
|--------------------------------------|---|-------------------------|----------|----|----|
| Seat height | 450 mm | | SH450 | ● | ● |
| | 500 mm | | SH500 | 45 | 45 |
| Frame | Steel | powder-coated | E-③ | ● | ● |
| | | chromium plated | E-CR | 20 | 30 |
| Backrest | Beech plywood | natural (natural beech) | BA-SKNB | ● | ● |
| | | stained | BA-① | 10 | 10 |
| | | veneered (natural oak) | BA-SKNO | 20 | 20 |
| Seat | Beech plywood (in backrest colour) | natural (natural beech) | SE-SKNB | ● | ● |
| | | stained | SE-① | 10 | 10 |
| | | veneered (natural oak) | SE-SKNO | 20 | 20 |
| Armpads | None | | | ● | ● |
| | Plastic, colour matching frame colour | | AP-④ | | 10 |
| | Plastic, black colour | | AP-KB | | |
| | Solid wood, colour matching seat and backrest colour | natural beech | AP-SKNB | — | 60 |
| | | stained beech | AP-① | | 65 |
| natural oak | AP-SKNO | | 70 | | |
| Glides | Plastic | | GD | ● | ● |
| | Plastic with felt | | GDF | ○ | ○ |
| | Protect glides | | GDT | ○ | ○ |
| Wood and wood-based materials | Raw material from certified forests, FSC certificate – authorized companies | | FSC | ● | ● |
| Wooden elements lacquering | Water lacquer | | | ● | ● |
| | UV water lacquer | | UV | 70 | 70 |
| Assembly | Assembled, cardboard packaging | | PACK-ASM | ● | ● |
| Sample order | SMILE FRAME CHAIR 4L W (SH450 E-BK BA-2.06S SE-2.06S GD FSC PACK-ASM) | | | | |

① – Please specify wood colour code – [see finishes](#)

③ – Please specify metal colour code – [see finishes](#)

④ – Please specify plastic colour code – [see finishes](#)

● Available as standard (included in basic price)

○ Available as an option (included in basic price)

Price list

High backrest and seat made of beech plywood.
Frame: 4 powder-coated metal legs, with or without armrests, stackable, replaceable plastic glides.



Smile plywood chair 4L with high backrest

Smile plywood chair 4L with high backrest and armrests

SMILE FRAME CHAIR 4L HB W

SMILE FRAME CHAIR 4LA HB W

W 465 mm
D 585 mm
H 845 mm
SH 450 mm
SH DIN 415 mm
WT 6,6 kg

W 545 mm
D 585 mm
H 845 mm
SH 450 mm
SH DIN 415 mm
WT 7,5 kg

Basic price (EUR)

200

220

| | | | | | |
|--------------------------------------|---|-------------------------|----------|----|----|
| Seat height | 450 mm | | SH450 | • | • |
| | 500 mm | | SH500 | 45 | 45 |
| Frame | Steel | powder-coated | E-③ | • | • |
| | | chromium plated | E-CR | 20 | 30 |
| Backrest | Beech plywood | natural (natural beech) | BA-SKNB | • | • |
| | | stained | BA-① | 10 | 10 |
| | | veneered (natural oak) | BA-SKNO | 20 | 20 |
| Seat | Beech plywood (in backrest colour) | natural (natural beech) | SE-SKNB | • | • |
| | | stained | SE-① | 10 | 10 |
| | | veneered (natural oak) | SE-SKNO | 20 | 20 |
| Armpads | None | | | • | • |
| | Plastic, colour matching frame colour | | AP-④ | | 10 |
| | Plastic, black colour | | AP-KB | | |
| | Solid wood, colour matching seat and backrest colour | natural beech | AP-SKNB | — | 60 |
| | | stained beech | AP-① | | 65 |
| natural oak | | AP-SKNO | | 70 | |
| Glides | Plastic | | GD | • | • |
| | Plastic with felt | | GDF | ○ | ○ |
| | Protect glides | | GDT | ○ | ○ |
| Wood and wood-based materials | Raw material from certified forests, FSC certificate – authorized companies | | FSC | • | • |
| Wooden elements lacquering | Water lacquer | | | • | • |
| | UV water lacquer | | UV | 70 | 70 |
| Assembly | Assembled, cardboard packaging | | PACK-ASM | • | • |
| Sample order | SMILE FRAME CHAIR 4L HB W (SH450 E-BK BA-SKNB SE-SKNB GD FSC PACK-ASM) | | | | |

① – Please specify wood colour code – [see finishes](#)

③ – Please specify metal colour code – [see finishes](#)

④ – Please specify plastic colour code – [see finishes](#)

• Available as standard (included in basic price)

○ Available as an option (included in basic price)

Price list

Upholstered backrest and seat.
Frame: 4 powder-coated metal legs, with or without armrests, stackable, replaceable plastic glides.



Smile upholstered chair 4L
Smile upholstered chair 4L with armrests

SMILE FRAME CHAIR 4L UPH
SMILE FRAME CHAIR 4LA UPH

W 465 mm
D 560 mm
H 800 mm
SH 470 mm
SH DIN 435 mm
WT 6,8 kg

W 545 mm
D 560 mm
H 800 mm
SH 470 mm
SH DIN 435 mm
WT 8,2 kg

Basic price (EUR) according to upholstery price group

| | 2 | 3 | 4 | 5 | 6 |
|--|-----|-----|-----|-----|-----|
| | 280 | 292 | 300 | 310 | 400 |
| | | | | | |
| | | | | | |
| | | | | | |
| | | | | | |
| | | | | | |

| | | | | | |
|--------------------------------------|---|---|------------------|----|----|
| Seat height | 470 mm | SH470 | • | • | |
| | 520 mm | SH520 | 45 | 45 | |
| Frame | Steel | powder-coated | E- ^③ | • | |
| | | chromium plated | E-CR | 20 | |
| Backrest | Upholstery (upholstery type and colour are the same for seat and backrest) | | BA- ^⑤ | • | |
| Seat | Upholstery (upholstery type and colour are the same for seat and backrest) | | SE- ^⑤ | • | |
| Armpads | None | | • | • | |
| | Plastic, colour matching frame colour | | AP- ^④ | 10 | |
| | Plastic, black colour | | AP-KB | | |
| | Solid wood | natural beech | AP-SKNB | — | 60 |
| | | stained beech | AP- ^① | — | 65 |
| | natural oak | AP-SKNO | — | 70 | |
| Glides | Plastic | | GD | • | |
| | Plastic with felt | | GDF | ○ | |
| | Protect glides | | GDT | ○ | |
| Foam | Flame retardant | | FFR2 | • | |
| | Flame retardant with fireproof fabric | | FFRF | 50 | |
| Wood and wood-based materials | Raw material from certified forests, FSC certificate – authorized companies | | FSC | • | |
| Wooden elements lacquering | None | for configurations without armpads and with plastic armpads | • | • | |
| | | for configurations with wooden armpads | — | • | |
| | UV water lacquer | UV | — | 15 | |
| Assembly | Assembled, cardboard packaging | | PACK-ASM | • | |

Sample order SMILE FRAME CHAIR 4L UPH (SH470 E-CR BA-CUR64195 SE-CUR64195 GD FFR2 FSC PACK-ASM)

① – Please specify wood colour code – [see finishes](#)

③ – Please specify metal colour code – [see finishes](#)

④ – Please specify plastic colour code – [see finishes](#)

⑤ – Please specify upholstery colour code from selected price group – [see finishes](#)

• Available as standard (included in basic price)

○ Available as an option (included in basic price)

PRICE GROUP 2: Cura, Cura Loop, Urban, Valencia, Xtreme
PRICE GROUP 3: Silvertex, Step/Step Melange
PRICE GROUP 4: Blazer, Main Line Flax, Oceanic, skai Parotega, Synergy

PRICE GROUP 5: Remix 3
PRICE GROUP 6: Nappa leather

Price list

Upholstered high backrest and seat.
Frame: 4 powder-coated metal legs, with or without armrests, stackable, replaceable plastic glides.



Smile upholstered chair 4L with high backrest

Smile upholstered chair 4L with high backrest and armrests

SMILE FRAME CHAIR 4L HB UPH

SMILE FRAME CHAIR 4LA HB UPH

W 465 mm
D 585 mm
H 845 mm
SH 470 mm
SH DIN 435 mm
WT 7,0 kg

W 545 mm
D 585 mm
H 845 mm
SH 470 mm
SH DIN 435 mm
WT 8,4 kg

Basic price (EUR) according to upholstery price group

| | 2 | 3 | 4 | 5 | 6 |
|--|-----|-----|-----|-----|-----|
| | 280 | 292 | 300 | 310 | 400 |
| | | | | | |
| | | | | | |
| | | | | | |
| | | | | | |
| | | | | | |

| | | | | | |
|--------------------------------------|---|-----------------|----------|----|----|
| Seat height | 470 mm | | SH470 | • | • |
| | 520 mm | | SH520 | 45 | 45 |
| Frame | Steel | powder-coated | E-③ | • | • |
| | | chromium plated | E-CR | 20 | 30 |
| Backrest | Upholstery (upholstery type and colour are the same for seat and backrest) | | BA-⑤ | • | • |
| Seat | Upholstery (upholstery type and colour are the same for seat and backrest) | | SE-⑤ | • | • |
| Armpads | None | | | • | • |
| | Plastic, colour matching frame colour | | AP-④ | | 10 |
| | Plastic, black colour | | AP-KB | | |
| | Solid wood | natural beech | AP-SKNB | — | 60 |
| | | stained beech | AP-① | | 65 |
| | natural oak | AP-SKNO | | 70 | |
| Glides | Plastic | | GD | • | • |
| | Plastic with felt | | GDF | ○ | ○ |
| | Protect glides | | GDT | ○ | ○ |
| Foam | Flame retardant | | FFR2 | • | • |
| | Flame retardant with fireproof fabric | | FFRF | 50 | 50 |
| Wood and wood-based materials | Raw material from certified forests, FSC certificate – authorized companies | | FSC | • | • |
| Wooden elements lacquering | None for configurations without armpads and with plastic armpads | | | • | • |
| | Water lacquer for configurations with wooden armpads | | | — | • |
| | UV water lacquer | | UV | | 15 |
| Assembly | Assembled, cardboard packaging | | PACK-ASM | • | • |

Sample order SMILE FRAME CHAIR 4L HB UPH (SH470 E-CR BA-CUR64195 SE-CUR64195 GD FFR2 FSC PACK-ASM)

① – Please specify wood colour code – [see finishes](#)

③ – Please specify metal colour code – [see finishes](#)

④ – Please specify plastic colour code – [see finishes](#)

⑤ – Please specify upholstery colour code from selected price group – [see finishes](#)

• Available as standard (included in basic price)

○ Available as an option (included in basic price)

Finishes

Wood

Natural



SKNB
Natural Beech



SKNO
Natural Oak

Stained



2.07Y
Black



2.06S
Slate



S39
Light Grey

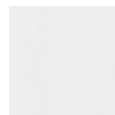

2.09S
White



2.0CB
Acacia



SK40
Oak



2.0CC
Walnut

Metal



**NCS S 2005-
Y60R**
Cashmere
NK



RAL 1024
Ochre Yellow
OY



RAL 030 50 40
Vermilion Red
VR



RAL 6003
Olive Green
OG



RAL 5000
Violet Blue
VB



Chrome
CR



RAL 9006
White
Aluminium
WK



RAL 9005
Jet Black
BK

Veneer



SKNO
Natural Oak

Plastic



KB
Black

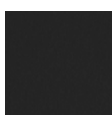

KG
Black Grey



WKP
White
Aluminium



VBP
Violet Blue



OGP
Olive Green



VRP
Vermilion
Red



OYP
Ochre Yellow



NKP
Cashmere

General notes

All specified dimensions are approximate. Subject to minor modifications or differences for reasons of design improvements or for technical reasons.

- W = width
- D = depth
- H = height
- DI = diameter
- SH = seat height
- SH DIN = seat height measured acc. to DIN EN 1335-1

In compliance with the highest quality standards "Quality is irreplaceable." Guided by this principle, each product line is subjected to stringent quality testing.

Only the products marked in this document are FSC® (FSC®-C120977). Look for our FSC®-certified products. Sale of products that meet the FSC® requirements is possible only by Nowy Styl Sp. z o.o., Nowy Styl Nederland B.V. and Kusch + Co GmbH.



The mark of responsible forestry

The FSC® certificate applies to responsible forest management and the entire flow of raw materials from the forest to the customer. Each stage of the chain is monitored in terms of social, ecological and economic performance. The product with the FSC® label gives customers a guarantee that the wood used for the production of the product comes from sources managed in a sustainable manner.

Warranty

Manufacturer declares that the products shall be free from defects in material or workmanship. The warranty is given to the original purchaser only, for normal commercial usage. Detailed terms of warranty and warranty periods are available at <https://www.kusch.com/en/warranty>

trio price list 2026

Trio

Design by Robert de le Roi

Stool on 4 metal legs



TRIO STOOL 4L W



TRIO STOOL 4L UPH

Chair on 4 metal legs, plywood shell



**TRIO FRAME
CHAIR 4L W**



**TRIO FRAME
CHAIR 4LA W**

Chair on 4 metal legs, upholstered shell



**TRIO FRAME CHAIR
4L UPH**



**TRIO FRAME CHAIR
4LA UPH**

Chair and bar hocker on sled metal frame, plywood shell



**TRIO FRAME CHAIR
CFS W**



**TRIO FRAME CHAIR
HKR CFS W**

Chair on sled metal frame, upholstered shell



**TRIO FRAME
CHAIR CFS UPH**

Bench, plywood shells



TRIO BENCH 2U 4L W



TRIO BENCH 3U 4L W



TRIO BENCH 4U 4L W



TRIO BENCH 5U 4L W

Bench, upholstered shells



TRIO BENCH 2U 4L UPH



TRIO BENCH 3U 4L UPH



TRIO BENCH 4U 4L UPH



TRIO BENCH 5U 4L UPH

Cantilever frame chair with armrests



TRIO FRAME CHAIR
CFA W



TRIO FRAME CHAIR
CFA UPH

Price list

Trio stool on 4 metal legs

Seat made of Topalit®, beech plywood or upholstered.
Frame on 4 legs made of powder-coated or chromium plated steel, stackable, plastic glides.



| | | | TRIO STOOL 4L W | TRIO STOOL 4L UPH |
|-----------------------------------|--|---------------------|---|---|
| | | | W 340 mm D 340 mm SH 450 mm SH DIN 445 mm WT 3 kg | W 340 mm D 340 mm SH 450 mm SH DIN 445 mm WT 3 kg |
| | | | Basic price (EUR) | Basic price (EUR) according to upholstery price group |
| | Price group 2 | | 140 | 148 |
| | Price group 3 | | | 151 |
| | Price group 4 | | | 155 |
| | Price group 5 | | | 159 |
| Frame | Steel | powder-coated | • | • |
| | | chromium plated E-③ | 20 | 20 |
| | | satin chrome | 24 | 24 |
| Seat | Natural Beech | SE-① | • | — |
| | stained | | 20 | |
| | Upholstered | SE-⑤ | — | • |
| Glides | Plastic | GD | • | • |
| | Plastic with felt | GDF | 8 | 8 |
| | Protect glides | GDT | 9 | 9 |
| Foam | Flame retardant foam | FFR2 | — | • |
| | Flame retardant foam with fireproof fabric | FFRF | | 23 |
| Wooden elements lacquering | Water lacquer UV | UV | • | — |
| | Water lacquer | | - 20 | — |
| Sample order | TRIO STOOL 4L W (E-WK SE-SS40 GD) | | | |

① – Please specify wood colour code – [see finishes](#)

③ – Please specify metal colour code – [see finishes](#)

⑤ – Please specify upholstery colour code from selected price group – [see finishes](#)

• Available as standard (included in basic price)

PRICE GROUP 2: Cura, Cura Loop, Valencia, Xtreme

PRICE GROUP 3: Silvertex, Step/Step Melange

PRICE GROUP 4: Blazer, Main Line Flax, Oceanic, skai Parotega, Synergy

PRICE GROUP 5: Remix 3

Trio chair on 4 metal legs, plywood shell

Shell made of beech plywood.
Frame on 4 legs made of powder-coated or chromium plated steel, with or without armrests, stackable, plastic glides.



| | | | | TRIO FRAME CHAIR 4L W | | | TRIO FRAME CHAIR 4LA W | | | |
|--------------|--|-----------------|-------------|---|----|----|---|----|----|---|
| | | | | W 500 mm D 550 mm H 820 mm SH 450 mm SH DIN 425 mm WT 5 kg | | | W 560 mm D 550 mm H 820 mm SH 450 mm SH DIN 425 mm WT 5,5 kg | | | |
| | | | | Basic price (EUR) | | | | | | |
| | | | | 205 | | | 280 | | | |
| Frame | Steel | powder-coated | | E-③ | • | | | • | | |
| | | chromium plated | | E-③ | 19 | | | 38 | | |
| | | satin chrome | | E-③ | 24 | | | 48 | | |
| Shell | Beech plywood | natural | | CC-① | • | | | • | | |
| | | stained | | CC-① | 19 | | | 19 | | |
| | | Laminated | | CC-① | 39 | | | 39 | | |
| | | natural | | CC-HH-① | 21 | 21 | | 21 | 21 | |
| | | stained | Handle hole | CC-HH-① | 40 | 40 | – | 40 | 40 | – |
| | | Laminated | | CC-HH-① | 60 | 60 | | 60 | 60 | |
| Backrest pad | Upholstered | None | | BA-PD-⑤ | • | | | • | | |
| | | Price group | 2 | BA-PD-⑤ | – | | | – | | |
| | | | 3 | BA-PD-⑤ | – | | | – | | |
| | | | 4 | BA-PD-⑤ | – | | | – | | |
| | | | 5 | BA-PD-⑤ | – | | | – | | |
| | | | 6 | BA-PD-⑤ | – | | | – | | |
| Seat pad | Upholstered | None | | SE-PD-⑤ | • | | | • | | |
| | | Price group | 2 | SE-PD-⑤ | – | | | – | | |
| | | | 3 | SE-PD-⑤ | – | | | – | | |
| | | | 4 | SE-PD-⑤ | – | | | – | | |
| | | | 5 | SE-PD-⑤ | – | | | – | | |
| | | | 6 | SE-PD-⑤ | – | | | – | | |
| Armrests | No armrest cover, armrests colour matching frame | | | ARF-③ | – | | | • | | |
| | Black plastic cover | | | ARF-KB | – | | | 38 | | |

① – Please specify wood colour code – [see finishes](#)

③ – Please specify metal colour code – [see finishes](#)

⑤ – Please specify upholstery colour code from selected price group – [see finishes](#)

• Available as standard (included in basic price)

PRICE GROUP 2: Cura, Cura Loop, Valencia, Xtreme
PRICE GROUP 3: Silvertex, Step/Step Melange
PRICE GROUP 4: Blazer, Main Line Flax, Oceanic, skai Parotega, Synergy
PRICE GROUP 5: Remix 3
PRICE GROUP 6: Nappa leather

Price list

| | | | | | TRIO FRAME CHAIR 4L W | | | TRIO FRAME CHAIR 4LA W | | |
|----------------------------------|---|--------------------------|--|-----------|-----------------------|----|----|------------------------|----|----|
| Writing tablet (490 × 260 mm) | None | | | | • | | | • | | |
| | Right version | Compact Laminate U0901TP | Chromium plated | WT-R-①/CR | 224 | | | 224 | | |
| | Left version | Traceless Black | | WT-L-①/CR | | | | | | |
| Linking element | None | | | | • | | | • | | |
| | Extractable | | | IN-CL | 49 | | | 49 | | |
| Seat numeration | None | | | | • | • | • | • | • | • |
| | Seat numberplate milled in the back | | | NO-ML | 17 | 17 | – | 17 | 17 | – |
| | Seat numberplate screwed to the back | | | NO-SC | – | – | 17 | – | – | 17 |
| Glides | Plastic | | | GD | • | | | • | | |
| | Plastic with felt | | | GDF | 8 | | | 8 | | |
| | Protect glides | | | GDT | 9 | | | 9 | | |
| Foam | Flame retardant foam | | | FFR2 | – | • | • | – | • | • |
| | Flame retardant foam with fireproof fabric | | | FFRF | – | 31 | 50 | – | 31 | 50 |
| Wood and wood-based materials | Raw material from certified forests, FSC certificate – authorized companies | For configuration: | • Natural beech shell • Stained beech shell | FSC | • | | | • | | |
| | | | • Writing tablet | FSCMIX | | | | | | |
| | Raw material – EU Timber regulation | | • with upholstered pads • Laminated shell | EUTR | | | | | | |
| Wooden elements lacquering | Water lacquer UV | | | UV | • | | | • | | |
| | Water lacquer | | | | – 20 | | | – 20 | | |
| Sample order | TRIO FRAME CHAIR 4L W (E-WK CC-SKNB GD FSC UV) | | | | | | | | | |

① – Please specify wood colour code – [see finishes](#)

③ – Please specify metal colour code – [see finishes](#)

• Available as standard (included in basic price)

Trio chair on 4 metal legs, upholstered shell

Upholstered shell.
Frame on 4 legs made of powder-coated or chromium plated steel, with or without armrests, stackable, plastic glides.



| | | | | TRIO FRAME CHAIR 4L UPH | TRIO FRAME CHAIR 4LA UPH |
|----------------------------------|---|---------------------------------|-----------|---|---|
| | | | | W 500 mm D 550 mm H 820 mm SH 450 mm SH DIN 435 mm WT 5,5 kg | W 560 mm D 550 mm H 820 mm SH 450 mm SH DIN 435 mm WT 6 kg |
| | | | | Basic price (EUR) according to upholstery price group | |
| Price group 2 | | | | 301 | 370 |
| Price group 3 | | | | 315 | 382 |
| Price group 4 | | | | 331 | 401 |
| Price group 5 | | | | 346 | 415 |
| Price group 6 | | | | 488 | 559 |
| Frame | Steel | powder-coated | E-③ | • | • |
| | | chromium plated | E-③ | 19 | 38 |
| | | satin chrome | | 24 | 48 |
| Shell | Upholstered | | BS-⑤ | • | • |
| Armrests | No armrest cover, armrests colour matching frame | | ARF-③ | — | • |
| | Black plastic cover | | ARF-KB | | 38 |
| Writing tablet (490 × 260 mm) | None | | | • | • |
| | Right version | Compact Laminate U0901TP Chrome | WT-R-①/CR | 224 | 224 |
| | Left version | Traceless Black | WT-L-①/CR | | |
| Linking element | None | | | • | • |
| | Extractable | | IN-CL | 49 | 49 |
| Seat numeration | None | | | • | • |
| | Seat numberplate screwed to the back | | NO-SC | 17 | 17 |
| Glides | Plastic | | GD | • | • |
| | Plastic with felt | | GDF | 8 | 8 |
| | Protect glides | | GDT | 9 | 9 |
| Foam | Flame retardant foam | | FFR2 | • | • |
| | Flame retardant foam with fireproof fabric | | FFRF | 93 | 93 |
| Wood and wood-based materials | Raw material from certified forests, FSC certificate – authorized companies | | FSC | • | • |
| | For configuration with a writing tablet | | FSCMIX | | |

Sample order TRIO FRAME CHAIR 4L UPH (E-WK BS-CPC10 GD FFR2 FSC)

- ① – Please specify wood colour code – [see finishes](#)
- ③ – Please specify metal colour code – [see finishes](#)
- ⑤ – Please specify upholstery colour code from selected price group – [see finishes](#)

• Available as standard (included in basic price)

PRICE GROUP 2: Cura, Cura Loop, Valencia, Xtreme
PRICE GROUP 3: Silvertex, Step/Step Melange
PRICE GROUP 4: Blazer, Main Line Flax, Oceanic, skai Parotega, Synergy
PRICE GROUP 5: Remix 3
PRICE GROUP 6: Nappa leather

Price list

Trio chair/bar hocker on sled metal frame, plywood shell

Shell made of beech plywood.
Sled frame made of powder-coated or chromium plated steel,
stackable, plastic glides.



| | | | | TRIO FRAME CHAIR CFS W | | TRIO FRAME CHAIR HKR CFS W | | | |
|--------------|---------------|-----------------|-------------|---|----|--|-----|-----|----|
| | | | | W 510 mm D 520 mm H 830 mm SH 450 mm SH DIN 435 mm WT 5,5 kg | | W 520 mm D 570 mm H 1140 mm SH 820 mm SH DIN 800 mm WT 7 kg | | | |
| | | | | Basic price (EUR) | | | | | |
| | | | | 269 | | 423 | | | |
| Frame | Steel | powder-coated | | • | | • | | | |
| | | chromium plated | E-③ | 38 | | 76 | | | |
| | | satin chrome | | 48 | | 95 | | | |
| Shell | Beech plywood | natural | | • | | • | | | |
| | | stained | CC-① | 19 | | 19 | | | |
| | | Laminated | | 56 | | — | | | |
| | | natural | | 21 | 21 | | | | |
| | | stained | Handle hole | CC-HH-① | 40 | 40 | — | — | |
| | | Laminated | 60 | 60 | | | | | |
| | None | | • | • | — | — | — | | |
| Backrest pad | Upholstered | Price group | 2 | | | 50 | | | |
| | | | 3 | | | 54 | | | |
| | | | 4 | BA-PD-⑤ | — | — | 61 | — | |
| | | | 5 | | | 66 | | | |
| | | | 6 | | | 106 | | | |
| | None | | • | — | — | • | — | | |
| Seat pad | Upholstered | Price group | 2 | | | 56 | 56 | 56 | |
| | | | 3 | | | 63 | 63 | 63 | |
| | | | 4 | SE-PD-⑤ | — | — | 70 | 70 | 70 |
| | | | 5 | | | 76 | 76 | 76 | |
| | | | 6 | | | 134 | 134 | 134 | |

① – Please specify wood colour code – [see finishes](#)

③ – Please specify metal colour code – [see finishes](#)

⑤ – Please specify upholstery colour code from selected price group – [see finishes](#)

• Available as standard (included in basic price)

PRICE GROUP 2: Cura, Cura Loop, Valencia, Xtreme
PRICE GROUP 3: Silvertex, Step/Step Melange
PRICE GROUP 4: Blazer, Main Line Flax, Oceanic, skai Parotega, Synergy
PRICE GROUP 5: Remix 3
PRICE GROUP 6: Nappa leather

| | | | | TRIO FRAME CHAIR CFS W | | | TRIO FRAME CHAIR HKR CFS W | |
|--------------------------------------|---|--------------------|-----|---------------------------|----|-----|-------------------------------|--|
| Linking element | None | | • | | | — | | |
| | Linking element for glides | IN-GD | 13 | | | | | |
| Seat numeration | None | | • | • | • | | | |
| | Seat numberplate milled in the back | NO-ML | 17 | 17 | — | — | | |
| | Seat numberplate screwed to the back | NO-SC | — | — | 17 | | | |
| Glides | Plastic | GD | • | | | • | | |
| | Plastic with felt | GDF | 8 | | | 8 | | |
| Foam | Flame retardant foam | FFR2 | — | • | • | — | • | |
| | Flame retardant foam with fireproof fabric | FFRF | | 31 | 50 | | 31 | |
| Wood and wood-based materials | Raw material from certified forests, FSC certificate – authorized companies | For configuration: | | • | | • | | |
| | Raw material – EU Timber regulation | | | • | | • | | |
| Wooden elements lacquering | Water lacquer UV | UV | • | | | • | | |
| | Water lacquer | | -20 | | | -20 | | |
| Sample order | TRIO FRAME CHAIR CFS W (E-WK CC-SKNB GD FSC UV) | | | | | | | |

- Available as standard (included in basic price)

Price list

Trio chair on sled metal frame, upholstered shell

Upholstered shell.
Frame made of powder-coated or chromium plated steel, stackable, plastic glides.



TRIO FRAME CHAIR CFS UPH

W 510 mm
D 520 mm
H 830 mm
SH 450 mm
SH DIN 445 mm
WT 6 kg

Basic price (EUR) according to upholstery price group

| | | | | |
|--------------------------------------|---|-----------------|------------------|-----|
| | Price group 2 | | | 360 |
| | Price group 3 | | | 373 |
| | Price group 4 | | | 392 |
| | Price group 5 | | | 406 |
| | Price group 6 | | | 548 |
| Frame | Steel | powder-coated | E- ^③ | • |
| | | chromium plated | | 38 |
| | | satin chrome | | 48 |
| Shell | Upholstered | | BS- ^⑤ | • |
| Linking element | None | | | • |
| | Linking element for glides | | IN-GD | 13 |
| Seat numeration | None | | | • |
| | Seat numberplate screwed to the back | | NO-SC | 17 |
| Glides | Plastic | | GD | • |
| | Plastic with felt | | GDF | 8 |
| Foam | Flame retardant foam | | FFR2 | • |
| | Flame retardant foam with fireproof fabric | | FFRF | 93 |
| Wood and wood-based materials | Raw material from certified forests, FSC certificate – authorized companies | | FSC | • |

Sample order TRIO FRAME CHAIR CFS UPH (E-WK BS-CPC10 GD FFR2 FSC)

^③ – Please specify metal colour code – [see finishes](#)

^⑤ – Please specify upholstery colour code from selected price group – [see finishes](#)

• Available as standard (included in basic price)

PRICE GROUP 2: Cura, Cura Loop, Valencia, Xtreme
PRICE GROUP 3: Silvertex, Step/Step Melange
PRICE GROUP 4: Blazer, Main Line Flax, Oceanic, skai Parotega, Synergy
PRICE GROUP 5: Remix 3
PRICE GROUP 6: Nappa leather

Trio bench, plywood shells

Shell made of beech plywood.
Legs made of powder-coated or chromium plated steel,
powder-coated beam, with or without armrests, plastic glides.



| | | TRIO BENCH 2U 4L W | | | TRIO BENCH 3U 4L W | | | | |
|---------------------|---------------------|--|---------------|-----------|---|-----|-----|-----|-----|
| | | W 1220 mm D 550 mm H 810 mm SH 450 mm SH DIN 425 mm | | | W 1750 mm D 550 mm H 810 mm SH 450 mm SH DIN 425 mm | | | | |
| | | Basic price (EUR) | | | | | | | |
| | | 687 | | | 899 | | | | |
| Frame | Beam | Legs | | | | | | | |
| | Powder-coated steel | Steel | powder-coated | • | | | | | |
| | | | chrome | E-(3)/(3) | 20 | | | 20 | |
| | | satin chrome | | 24 | | | 24 | | |
| Shell | Beech plywood | natural | • | | | | • | | |
| | | stained | CC-(1) | 40 | | | 60 | | |
| | | Laminated | | 112 | | | 167 | | |
| Backrest pad | Upholstered | Price group | None | • | | | • | | |
| | | | 2 | 100 | | | 150 | | |
| | | | 3 | 107 | | | 162 | | |
| | | | 4 | BA-PD-(5) | 121 | | | 183 | |
| | | | 5 | | 131 | | | 198 | |
| | | | 6 | | 211 | | | 318 | |
| Seat pad | Upholstered | Price group | None | • | | | • | | |
| | | | 2 | 112 | | 168 | | 168 | |
| | | | 3 | 126 | | 189 | | 189 | |
| | | | 4 | SE-PD-(5) | 140 | | 210 | | 210 |
| | | | 5 | | 152 | | 228 | | 228 |
| | | | 6 | | 268 | | 402 | | 402 |
| Armrests | None | • | | | • | | | | |
| | External | One armrest – available only with seat – replacing top on the edge of bench | 51 | | | 51 | | | |
| | | Two armrests on both sides of bench – not available with seat-replacing top on the edge of bench | Powder-coated | 102 | | | 102 | | |
| | Internal | ARM-EX-(3) | 51 | | | 102 | | | |
| All | ARM-IN-(3) | 153 | | | 204 | | | | |
| | | | ARM-EI-(3) | 153 | | | 204 | | |

① – Please specify wood colour code – [see finishes](#)

③ – Please specify metal colour code – [see finishes](#)

⑤ – Please specify upholstery colour code from selected price group – [see finishes](#)

• Available as standard (included in basic price)

PRICE GROUP 2: Cura, Cura Loop, Valencia, Xtreme
PRICE GROUP 3: Silvertex, Step/Step Melange
PRICE GROUP 4: Blazer, Main Line Flax, Oceanic, skai Parotega, Synergy
PRICE GROUP 5: Remix 3
PRICE GROUP 6: Nappa leather

Price list

| | | | | | TRIO BENCH 2U 4L W | | | TRIO BENCH 3U 4L W | | | |
|-----------------------------------|---|--------------------------|---------------------------------|----------------|-------------------------|--------|----|--------------------|------|----|-----|
| Seat-replacing top (440 × 400 mm) | None | | | | • | | | • | | | |
| | Top position (7) | | Top finish (1) Frame finish (3) | | | | | | | | |
| | A or B | Compact Laminate U0901TP | Powder-coated | TF-(7)-(1)/(3) | 16 | | | – | | | |
| | A, B or C | Traceless Black | | | – | | | - 16 | | | |
| Wall spacer | None | | | | • | | | • | | | |
| | Wall spacer | | | | IN-WS | 117 | | | 117 | | |
| Glides | Plastic | | | | GD | • | | | • | | |
| Foam | Flame retardant foam | | | | FFR2 | • • | | | • • | | |
| | Flame retardant foam with fireproof fabric | | | | FFRF | – | 61 | 99 | – | 91 | 148 |
| Wood and wood-based materials | Raw material from certified forests, FSC certificate – authorized companies | | For configuration: | | • Natural beech shell | FSC | | | | | |
| | | | | | • Stained beech shell | | | | | | |
| | Raw material – EU Timber regulation | | | | • Seat-replacing top | FSCMIX | | | • | | |
| | | | | | • with upholstered pads | EUTR | | | | | |
| | | | | | • Laminated shell | | | | | | |
| Wooden elements lacquering | Water lacquer UV | | | | UV | • | | | • | | |
| | Water lacquer | | | | | - 40 | | | - 60 | | |
| Sample order | TRIO BENCH 2U 4L W (E-WK/CR CC-SKNB GD FSC UV) | | | | | | | | | | |

① – Please specify wood colour code – [see finishes](#)

③ – Please specify metal colour code – [see finishes](#)

⑦ – Please specify seat-replacing top position

• Available as standard (included in basic price)

Trio bench, plywood shells

Shell made of beech plywood.
 Legs made of powder-coated or chromium plated steel,
 powder-coated beam, with or without armrests, plastic glides.



| | | TRIO BENCH 4U 4L W | | | TRIO BENCH 5U 4L W | | | | |
|--------------|---------------------|--|---------------------|----------|---|-----|-----|-----|--|
| | | W 2280 mm D 550 mm H 810 mm SH 450 mm SH DIN 425 mm | | | W 2810 mm D 550 mm H 810 mm SH 450 mm SH DIN 425 mm | | | | |
| | | Basic price (EUR) | | | | | | | |
| | | 1182 | | | 1393 | | | | |
| Frame | Beam | Legs | | | | | | | |
| | Powder-coated steel | Steel | powder-coated | • | | • | | | |
| | | | chrome E-③/③ | 30 | | 30 | | | |
| | | satin chrome | | 36 | | 36 | | | |
| Shell | Beech plywood | natural | • | | • | | | | |
| | | stained CC-① | 80 | | 100 | | | | |
| | | Laminated | 223 | | 279 | | | | |
| Backrest pad | Upholstered | Price group | None | • | | • | | • | |
| | | | 2 | | | 200 | | 250 | |
| | | | 3 | | | 216 | | 270 | |
| | | | 4 BA-PD-⑤ | - | | 244 | | 305 | |
| | | | 5 | | | 264 | | 330 | |
| | | | 6 | | | 424 | | 530 | |
| Seat pad | Upholstered | Price group | None | • | | - | | - | |
| | | | 2 | | | 224 | | 280 | |
| | | | 3 | | | 252 | | 315 | |
| | | | 4 SE-PD-⑤ | - | | 280 | | 350 | |
| | | | 5 | | | 304 | | 380 | |
| | | | 6 | | | 536 | | 670 | |
| Armrests | External | One armrest – available only with seat – replacing top on the edge of bench | Powder-coated steel | ARM-EX-③ | | • | | • | |
| | | | | ARM-EX-③ | | 51 | | 51 | |
| | Internal | Two armrests on both sides of bench – not available with seat-replacing top on the edge of bench | ARM-IN-③ | | 102 | | 102 | | |
| | | | ARM-IN-③ | | 153 | | 204 | | |
| | All | Not available with seat-replacing top | ARM-EI-③ | | 255 | | 306 | | |

- ① – Please specify wood colour code – [see finishes](#)
 ③ – Please specify metal colour code – [see finishes](#)
 ⑤ – Please specify upholstery colour code from selected price group – [see finishes](#)
- Available as standard (included in basic price)

PRICE GROUP 2: Cura, Cura Loop, Valencia, Xtreme
 PRICE GROUP 3: Silvertex, Step/Step Melange
 PRICE GROUP 4: Blazer, Main Line Flax, Oceanic, skai Parotega, Synergy
 PRICE GROUP 5: Remix 3
 PRICE GROUP 6: Nappa leather

Price list

| | | | | | TRIO BENCH 4U 4L W | TRIO BENCH 5U 4L W | | |
|-----------------------------------|---|--------------------------|-------------------------|----------------|--------------------|--------------------|---|---|
| Seat-replacing top (440 × 400 mm) | None | | | | • | • | | |
| | Top position (7) | Top finish (1) | Frame finish (3) | | | | | |
| | A, B, C or D | Compact Laminate U0901TP | Powder-coated | TF-(7)-(1)/(3) | - 16 | – | | |
| | A, B, C, D or E | Traceless Black | | | – | - 16 | | |
| Wall spacer | None | | | | • | • | | |
| | Wall spacer | | IN-WS | | 117 | 117 | | |
| Glides | Plastic | | GD | | • | • | | |
| Foam | Flame retardant foam | | FFR2 | – | • | • | | |
| | Flame retardant foam with fireproof fabric | | FFRF | | 121 | 197 | – | • |
| Wood and wood-based materials | Raw material from certified forests, FSC certificate – authorized companies | For configuration: | • Natural beech shell | FSC | | | | |
| | | | • Stained beech shell | | | | | |
| | | • Seat-replacing top | FSCMIX | | • | | • | |
| | Raw material – EU Timber regulation | | • with upholstered pads | EUTR | | | | |
| Wooden elements lacquering | Water lacquer UV | | UV | | • | • | | |
| | Water lacquer | | | | - 80 | - 100 | | |

Sample order TRIO BENCH 4U 4L W (E-WK/CR CC-SKNB GD FSC UV)

① – Please specify wood colour code – [see finishes](#)

③ – Please specify metal colour code – [see finishes](#)

⑦ – Please specify seat-replacing top position

• Available as standard (included in basic price)

Trio bench, upholstered shells

Upholstered shell.

Legs made of powder-coated or chromium plated steel, powder-coated stretcher beam, with or without armrests, plastic glides.

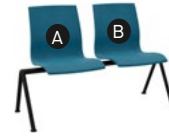

TRIO BENCH 2U 4L UPH

W 1220 mm
D 550 mm
H 810 mm
SH 450 mm
SH DIN 425 mm

Basic price (EUR) according to upholstery price group

| | | | | | | |
|--|---|--|---|---------------|----------------|-------|
| | Price group 2 | | | | | 881 |
| | Price group 3 | | | | | 910 |
| | Price group 4 | | | | | 945 |
| | Price group 5 | | | | | 975 |
| | Price group 6 | | | | | 1282 |
| Frame | Beam | Legs | | | | |
| | Powder-coated steel | Steel | powder-coated | E-(3)/(3) | | • |
| | | | chromium plated | | | 20 |
| | | | satin chrome | | | 24 |
| Shell | Upholstered | | | BS-(5) | | • |
| | None | | | | | • |
| Armrests | External | One armrest – available only with seat – replacing top on the edge of bench | | Powder-coated | ARM-EX-(3) | 51 |
| | | Two armrests on both sides of bench – not available with seat-replacing top on the edge of bench | | | | 102 |
| | Internal | Not available with seat-replacing top | | | ARM-IN-(3) | 51 |
| | All | | | | ARM-EI-(3) | 153 |
| | None | | | | | • |
| Seat-replacing top (440 × 400 mm) | Top position (7) | Top finish (1) | Frame finish (3) | Price group | | |
| | | | | 2 | | - 103 |
| | | | | 3 | | - 118 |
| | A or B | Compact Laminate U0901TP | Powder-coated | 4 | TF-(7)-(1)/(3) | - 136 |
| | | Traceless Black | | 5 | | - 151 |
| | | | | 6 | | - 304 |
| Wall spacer | None | | | | | • |
| | Wall spacer | | | | IN-WS | 117 |
| Glides | Plastic | | | | GD | • |
| Foam | Flame retardant foam | | | | FFR2 | • |
| | Flame retardant foam with fireproof fabric | | | | FFRF | 91 |
| Wood and wood-based materials | Raw material from certified forests, FSC certificate – authorized companies | | | | FSC | |
| | | | For configuration with a seat-replacing top | | FSCMIX | • |

Sample order TRIO BENCH 2U 4L UPH (E-WK/CR BS-CPC10 GD FFR2 FSC)

- ① – Please specify wood colour code – [see finishes](#)
- ③ – Please specify metal colour code – [see finishes](#)
- ⑤ – Please specify upholstery colour code from selected price group – [see finishes](#)
- ⑦ – Please specify seat-replacing top position

- Available as standard (included in basic price)

PRICE GROUP 2: Cura, Cura Loop, Valencia, Xtreme
 PRICE GROUP 3: Silvertex, Step/Step Melange
 PRICE GROUP 4: Blazer, Main Line Flax, Oceanic, skai Parotega, Synergy
 PRICE GROUP 5: Remix 3
 PRICE GROUP 6: Nappa leather

Price list

Trio bench, upholstered shells

Upholstered shell.
Legs made of powder-coated or chromium plated steel,
powder-coated stretcher beam, with or without armrests, plastic glides.

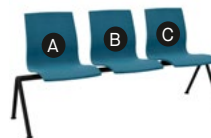

TRIO BENCH 3U 4L UPH

W 1750 mm
D 550 mm
H 810 mm
SH 450 mm
SH DIN 425 mm

Basic price (EUR) according to upholstery price group

| | | | | | | |
|--|---|--|---|-------------|--------------|-------|
| | Price group 2 | | | | | 1187 |
| | Price group 3 | | | | | 1232 |
| | Price group 4 | | | | | 1285 |
| | Price group 5 | | | | | 1330 |
| | Price group 6 | | | | | 1790 |
| | Beam | Legs | | | | |
| Frame | Powder-coated steel | Steel | powder-coated | E-(3)/3 | | • |
| | | | chromium plated | | | 20 |
| | | | satin chrome | | | 24 |
| Shell | Upholstered | | | BS-(5) | | • |
| | None | | | | | • |
| Armrests | External | One armrest – available only with seat – replacing top on the edge of bench | | ARM-EX-(3) | | 51 |
| | | Two armrests on both sides of bench – not available with seat-replacing top on the edge of bench | | | | 102 |
| | Internal | | | ARM-IN-(3) | | 102 |
| | All | Not available with seat-replacing top | | | ARM-EI-(3) | |
| | None | | | | | • |
| Seat-replacing top (440 × 400 mm) | Top position (7) | Top finish (1) | Frame finish (3) | Price group | | |
| | | | | 2 | | - 103 |
| | | | | 3 | | - 118 |
| | A, B or C | Compact Laminate U0901TP | Powder-coated | 4 | TF-(7)-(1)/3 | - 136 |
| | | Traceless Black | | 5 | | - 151 |
| | | | | 6 | | - 304 |
| Wall spacer | None | | | | | • |
| | Wall spacer | | | IN-WS | | 117 |
| Glides | Plastic | | | GD | | • |
| Foam | Flame retardant foam | | | FFR2 | | • |
| | Flame retardant foam with fireproof fabric | | | FFRF | | 184 |
| Wood and wood-based materials | Raw material from certified forests, FSC certificate – authorized companies | | | FSC | | • |
| | | | For configuration with a seat-replacing top | FSCMIX | | |

Sample order TRIO BENCH 3U 4L UPH (E-WK/CR BS-CPC10 GD FFR2 FSC)

- ① – Please specify wood colour code – [see finishes](#)
 - ③ – Please specify metal colour code – [see finishes](#)
 - ⑤ – Please specify upholstery colour code from selected price group – [see finishes](#)
 - ⑦ – Please specify seat-replacing top position
- Available as standard (included in basic price)

PRICE GROUP 2: Cura, Cura Loop, Valencia, Xtreme
PRICE GROUP 3: Silvertex, Step/Step Melange
PRICE GROUP 4: Blazer, Main Line Flax, Oceanic, skai Parotega, Synergy
PRICE GROUP 5: Remix 3
PRICE GROUP 6: Nappa leather

Trio bench, upholstered shells

Upholstered shell.

Legs made of powder-coated or chromium plated steel, powder-coated stretcher beam, with or without armrests, plastic glides.

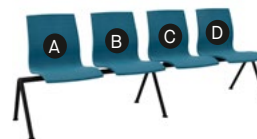

TRIO BENCH 4U 4L UPH

W 2280 mm
D 550 mm
H 810 mm
SH 450 mm
SH DIN 425 mm

Basic price (EUR) according to upholstery price group

| | | | | | | | |
|--|---|--|---|---------------|----------------|------|-----|
| | Price group 2 | | | | | 1567 | |
| | Price group 3 | | | | | 1625 | |
| | Price group 4 | | | | | 1698 | |
| | Price group 5 | | | | | 1756 | |
| | Price group 6 | | | | | 2368 | |
| Frame | Beam | Legs | | | | • | |
| | Powder-coated steel | Steel | powder-coated | E-(3)/(3) | | • | |
| | | | chromium plated | | | 30 | |
| | | | satin chrome | | | 36 | |
| Shell | Upholstered | | | BS-(5) | | • | |
| | None | | | | | • | |
| Armrests | External | One armrest – available only with seat – replacing top on the edge of bench | | | | 51 | |
| | | Two armrests on both sides of bench – not available with seat-replacing top on the edge of bench | | Powder-coated | ARM-EX-(3) | | 102 |
| | Internal | Not available with seat-replacing top | | | ARM-IN-(3) | | 153 |
| | All | | | | ARM-EI-(3) | | 255 |
| | None | | | | | • | |
| Seat-replacing top (440×400 mm) | Top position (7) | Top finish (1) | Frame finish (3) | Price group | | | |
| | A, B, C or D | Compact Laminate U0901TP Traceless Black | Powder-coated | 2 | TF-(7)-(1)/(3) | -103 | |
| | | | | 3 | | -118 | |
| | | | | 4 | | -136 | |
| | | | | 5 | | -151 | |
| | | | | 6 | | -304 | |
| | | | | | | | |
| Wall spacer | None | | | | | • | |
| | Wall spacer | | | IN-WS | | 117 | |
| Glides | Plastic | | | GD | | • | |
| Foam | Flame retardant foam | | | FFR2 | | • | |
| | Flame retardant foam with fireproof fabric | | | FFRF | | 370 | |
| Wood and wood-based materials | Raw material from certified forests, FSC certificate – authorized companies | | | FSC | | • | |
| | | | For configuration with a seat-replacing top | FSCMIX | | • | |

Sample order TRIO BENCH 4U 4L UPH (E-WK/CR BS-CPC10 GD FFR2 FSC)

- ① – Please specify wood colour code – [see finishes](#)
- ③ – Please specify metal colour code – [see finishes](#)
- ⑤ – Please specify upholstery colour code from selected price group – [see finishes](#)
- ⑦ – Please specify seat-replacing top position
- Available as standard (included in basic price)

PRICE GROUP 2: Cura, Cura Loop, Valencia, Xtreme
PRICE GROUP 3: Silvertex, Step/Step Melange
PRICE GROUP 4: Blazer, Main Line Flax, Oceanic, skai Parotega, Synergy
PRICE GROUP 5: Remix 3
PRICE GROUP 6: Nappa leather

Price list

Trio bench, upholstered shells

Upholstered shell.
Legs made of powder-coated or chromium plated steel,
powder-coated stretcher beam, with or without armrests, plastic glides

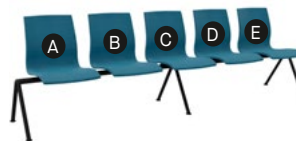

TRIO BENCH 5U 4L UPH

W 2810 mm
D 550 mm
H 810 mm
SH 450 mm
SH DIN 425 mm

Basic price (EUR) according to upholstery price group

| | | | | | | |
|--|---|--|---|-------------|----------------|-------|
| | Price group 2 | | | | | 1873 |
| | Price group 3 | | | | | 1948 |
| | Price group 4 | | | | | 2037 |
| | Price group 5 | | | | | 2111 |
| | Price group 6 | | | | | 2877 |
| | Beam | Legs | | | | |
| Frame | Powder-coated steel | Steel | powder-coated | E-(3)/(3) | | • |
| | | | chromium plated | | | 30 |
| | | | satin chrome | | | 36 |
| Shell | Upholstered | | | BS-(5) | | • |
| | None | | | | | • |
| Armrests | External | One armrest – available only with seat – replacing top on the edge of bench | | ARM-EX-(3) | | 51 |
| | | Two armrests on both sides of bench – not available with seat-replacing top on the edge of bench | | | | 102 |
| | Internal | | | ARM-IN-(3) | | 204 |
| | All | Not available with seat-replacing top | | | ARM-EI-(3) | |
| | None | | | | | • |
| Seat-replacing top (440 × 400 mm) | Top position (7) | Top finish (1) | Frame finish (3) | Price group | | |
| | | | | 2 | | - 103 |
| | | | | 3 | | - 118 |
| | A, B, C, D or E | Compact Laminate U0901TP Traceless Black | Powder-coated | 4 | TF-(7)-(1)/(3) | - 136 |
| | | | | 5 | | - 151 |
| | | | | 6 | | - 304 |
| Wall spacer | None | | | | | • |
| | Wall spacer | | | IN-WS | | 117 |
| Glides | Plastic | | | GD | | • |
| Foam | Flame retardant foam | | | FFR2 | | • |
| | Flame retardant foam with fireproof fabric | | | FFRF | | 463 |
| Wood and wood-based materials | Raw material from certified forests, FSC certificate – authorized companies | | | FSC | | • |
| | | | For configuration with a seat-replacing top | FSCMIX | | |

Sample order TRIO BENCH 5U 4L UPH (E-WK/CR BS-CPC10 GD FFR2 FSC)

- ① – Please specify wood colour code – [see finishes](#)
 - ③ – Please specify metal colour code – [see finishes](#)
 - ⑤ – Please specify upholstery colour code from selected price group – [see finishes](#)
 - ⑦ – Please specify seat-replacing top position
- Available as standard (included in basic price)

PRICE GROUP 2: Cura, Cura Loop, Valencia, Xtreme
PRICE GROUP 3: Silvertex, Step/Step Melange
PRICE GROUP 4: Blazer, Main Line Flax, Oceanic, skai Parotega, Synergy
PRICE GROUP 5: Remix 3
PRICE GROUP 6: Nappa leather

Floor fixing (type 1)

Set of floor fixing elements

| |
|-----------------------------|
| BENCH ACCESSORY FF 1 |
| Basic price (EUR) |
| 63 |

Price list

Trio cantilever frame chair with armrests

Plywood or upholstered seat and backrest.
Cantilever frame made of powder-coated or chromium plated steel,
with armrests, stackable, no glides.



| | | | | TRIO FRAME CHAIR CFA W | TRIO FRAME CHAIR CFA UPH | | |
|---------------------|---------------|-----------------|-----------------------|---|---|---|---|
| | | | | W 540 mm D 540 mm H 820 mm SH 450 mm SH DIN 430 mm WT 8,5 kg | W 540 mm D 540 mm H 820 mm SH 450 mm SH DIN 440 mm WT 9 kg | | |
| | | | | Basic price (EUR) | | | Basic price (EUR) according to upholstery price group |
| Price group 2 | | | | | | | 455 |
| Price group 3 | | | | | | | 469 |
| Price group 4 | | | | 360 | | | 491 |
| Price group 5 | | | | | | | 504 |
| Price group 6 | | | | | | | 656 |
| Frame | Steel | powder-coated | E- ^③ | • | | | • |
| | | chromium plated | | 40 | | | 40 |
| | | satin chrome | | 48 | | | 48 |
| Shell | Beech plywood | natural | CC- ^① | • | | | - |
| | | stained | | 20 | | | |
| | | Laminated | | 56 | | | |
| | | natural | CC-HH- ^① | 22 | 22 | - | |
| | | stained | | 42 | 42 | | |
| Laminated | | 78 | 78 | | | | |
| | Upholstered | | BS- ^⑤ | - | | | • |
| | None | | | • | • | - | |
| Backrest pad | Upholstered | Price group | 2 3 4 5 6 | BA-PD- ^⑤ | - | - | 53 |
| | | | | | | | 57 |
| | | | | | | | 64 |
| | | | | | | | 69 |
| | | | | | | | 112 |

① - Please specify wood colour code - [see finishes](#)

③ - Please specify metal colour code - [see finishes](#)

⑤ - Please specify upholstery colour code from selected price group - [see finishes](#)

• Available as standard (included in basic price)

PRICE GROUP 2: Cura, Cura Loop, Valencia, Xtreme
PRICE GROUP 3: Silvertex, Step/Step Melange
PRICE GROUP 4: Blazer, Main Line Flax, Oceanic, skai Parotega, Synergy
PRICE GROUP 5: Remix 3
PRICE GROUP 6: Nappa leather

| | | | | | TRIO FRAME CHAIR CFA W | | | TRIO FRAME CHAIR CFA UPH | | |
|-------------------------------|---|--------------------|-------------------------|---------|---------------------------|-----|-----|-----------------------------|----|---|
| Seat pad | None | | | | • | – | – | | | |
| | Upholstered | Price group | 2 | SE-PD-⑤ | – | 59 | 59 | | | |
| | | | 3 | | | 66 | 66 | | | |
| | | | 4 | | | 74 | 74 | | | – |
| | | | 5 | | | 80 | 80 | | | |
| | | | 6 | | | 142 | 142 | | | |
| Armrests | No armrest cover, armrests colour matching frame | | ARF-③ | | • | | | | • | |
| | Black plastic cover | | ARF-KB | | 40 | | | | 40 | |
| Glides | No glides | | | | • | | | | • | |
| | Plastic | | GD | | 23 | | | | 23 | |
| | Plastic with felt | | GDF | | 31 | | | | 31 | |
| | Protect glides | | GDT | | 41 | | | | 41 | |
| Foam | Flame retardant foam | | FFR2 | | – | • | • | | • | |
| | Flame retardant foam with fireproof fabric | | FFRF | | | 31 | 50 | | 93 | |
| Wood and wood-based materials | Raw material from certified forests, FSC certificate – authorized companies | For configuration: | • upholstered shell | FSC | | – | | | • | |
| | | | • Natural beech shell | FSC | | • | | | – | |
| | | | • with upholstered pads | EUTR | | | | | | |
| | Raw material – EU Timber regulation | | • Laminated shell | | | | | | | |
| Wooden elements lacquering | Water lacquer UV | | UV | | • | | | | – | |
| | | | | | | –20 | | | – | |

Sample order TRIO FRAME CHAIR CFA W (E-WK CC-SKNB ARF-WK-KB FSC UV)

- ③ – Please specify metal colour code – [see finishes](#)
 ④ – Please specify plastic colour code – [see finishes](#)
 ⑤ – Please specify upholstery colour code from selected price group – [see finishes](#)

• Available as standard (included in basic price)

PRICE GROUP 2: Cura, Cura Loop, Valencia, Xtreme
 PRICE GROUP 3: Silvertex, Step/Step Melange
 PRICE GROUP 4: Blazer, Main Line Flax, Oceanic, skai Parotega, Synergy
 PRICE GROUP 5: Remix 3
 PRICE GROUP 6: Nappa leather

Finishes

Wood

Natural



SKNB
Natural
Beech

Stained



2.07Y
Black



2.06S
Slate



S39
Light Grey

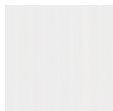

2.09S
White



2.0CB
Acacia



SK40
Oak



2.0CC
Walnut

Metal

for chairs



**NCS S
2005-Y60R**
Cashmere
NK



RAL 1024
Ochre Yellow
OY



**RAL 030
50 40**
Vermilion
Red
VR



RAL 6003
Olive Green
OG



RAL 5000
Violet Blue
VB



Chrome
CR



**Satin
Chrome**
SCR



RAL 9005
Jet Black
BK



Silver 98
SV



RAL 9006
White
Aluminium
WK

for benches



RAL 9005
Jet Black
BK



Silver 98
SV



RAL 9006
White
Aluminium
WK

Laminate



H3349
Kaisersberg
Oak



H1733
Mainau Birch

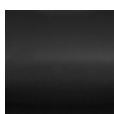

U999
Black



U963
Dark Grey



U708
Light Grey



U626
Kiwi Green



U504
Tyrolean
Blue

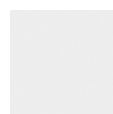

W1000
Premium
White

Compact Laminate

For top replacing seat and tablet



U0901TP
Traceless
Black

Plastic



KB
Black

General notes

All specified dimensions are approximate. Subject to minor modifications or differences for reasons of design improvements or for technical reasons.

- W = width
- D = depth
- H = height
- DI = diameter
- SH = seat height
- SH DIN = seat height measured acc. to DIN EN 1335-1
- WT = weight

In compliance with the highest quality standards "Quality is irreplaceable." Guided by this principle, each product line is subjected to stringent quality testing.

Only the products marked in this document are FSC® (FSC®-C120977).

Look for our FSC®-certified products.

Sale of products that meet the FSC® requirements is possible only by Nowy Styl Sp. z o.o., Nowy Styl Nederland B.V. and Kusch + Co GmbH.



The mark of responsible forestry

The FSC® certificate applies to responsible forest management and the entire flow of raw materials from the forest to the customer. Each stage of the chain is monitored in terms of social, ecological and economic performance. The product with the FSC® label gives customers a guarantee that the wood used for the production of the product comes from sources managed in a sustainable manner.

Warranty

Manufacturer declares that the products shall be free from defects in material or workmanship. The warranty is given to the original purchaser only, for normal commercial usage.

Detailed terms of warranty and warranty periods are available at

<https://www.kusch.com/en/warranty>

duo price list 2026

Duo

Design by Kusch + Co Designteam

Chair on 4 metal legs, plywood shell



DUO FRAME CHAIR 4L W



DUO FRAME CHAIR 4LA W

Chair on 4 metal legs, upholstered shell



DUO FRAME CHAIR 4L UPH



DUO FRAME CHAIR 4LA UPH

Price list

Duo chair on 4 metal legs, plywood shell

Shell made of beech plywood.
Frame on 4 legs made of powder-coated or chromium plated steel, with or without armrests, stackable, plastic glides.



| | | | | DUO FRAME CHAIR 4L W | DUO FRA ME CHAIR 4LA W | |
|-------------------------------|--|-----------------|---------|--|---|-----|
| | | | | W 510 mm D 560 mm H 820 mm SH 45 mm SH DIN 420 mm WT 5,5 kg | W 580 mm D 560 mm H 820 mm SH 450 mm SH DIN 420 mm WT 6 kg | |
| | | | | Basic price (EUR) | | |
| | | | | 210 | 280 | |
| Frame | Steel | powder-coated | E-③ | • | • | |
| | | chromium plated | E-CR | 20 | 40 | |
| Shell | Beech plywood | natural | CC-① | • | • | |
| | | stained | | 20 | 20 | |
| | | natural | CC-HH-① | 22 | 22 | |
| | | stained | | 42 | 42 | |
| Seat pad | Upholstered | None | | • | • | |
| | | Price group | 2 | | 59 | 59 |
| | | | 3 | | 66 | 66 |
| | | | 4 | SE-PD-⑤ | 74 | 74 |
| | | | 5 | | 80 | 80 |
| | | | 6 | | 142 | 142 |
| Armpads | None | | – | • | | |
| | Black plastic armpads | AP-KB | | 40 | | |
| Linking element | None | | • | • | | |
| | Extractable | IN-CL | 52 | 52 | | |
| Glides | Plastic | GD | • | • | | |
| | Plastic with felt | GDF | 8 | 8 | | |
| | Protect glides | GDT | 9 | 9 | | |
| Foam | Flame retardant foam | FFR2 | – | • | | |
| | Flame retardant foam with fireproof fabric | FFRF | | 31 | | |
| Wood and wood-based materials | Raw material - EU Timber regulation | EUTR | • | • | | |
| Wooden elements lacquering | Water lacquer UV | UV | • | • | | |
| | Water lacquer | | –20 | –20 | | |

Sample order DUO FRAME CHAIR 4L W (E-WK CC-SKNB GD EUTR UV)

- ① – Please specify wood colour code – [see finishes](#)
- ③ – Please specify metal colour code – [see finishes](#)
- ⑤ – Please specify upholstery colour code from selected price group – [see finishes](#)
- Available as standard (included in basic price)

PRICE GROUP 2: Cura, Cura Loop, Valencia, Xtreme
PRICE GROUP 3: Silvertex, Step/Step Melange
PRICE GROUP 4: Blazer, Main Line Flax, Oceanic, skai Parotega, Synergy
PRICE GROUP 5: Remix 3
PRICE GROUP 6: Nappa leather

Price list

Duo chair on 4 metal legs, upholstered shell

Upholstered shell.

Frame on 4 legs made of powder-coated or chromium plated steel, with or without armrests, stackable, plastic glides.



DUO FRAME CHAIR 4L UPH

W 510 mm
D 560 mm
H 820 mm
SH 450 mm
SH DIN 430 mm
WT 6,5 kg

DUO FRAME CHAIR 4LA UPH

W 580 mm
D 560 mm
H 820 mm
SH 450 mm
SH DIN 430 mm
WT 7,0 kg

Basic price (EUR) according to upholstery price group

| | | | | 300 | 371 |
|--------------------------------------|--|-----------------|-------|-----|-----|
| | Price group 2 | | | | |
| | Price group 3 | | | 314 | 384 |
| | Price group 4 | | | 335 | 407 |
| | Price group 5 | | | 348 | 420 |
| | Price group 6 | | | 503 | 574 |
| Frame | Steel | powder-coated | E-③ | • | • |
| | | chromium plated | E-CR | 20 | 40 |
| Shell | Upholstered | | BS-⑤ | • | • |
| Armpads | None | | | — | • |
| | Black plastic armpads | | AP-KB | | 40 |
| Linking element | None | | | • | • |
| | Extractable | | IN-CL | 52 | 52 |
| Glides | Plastic | | GD | • | • |
| | Plastic with felt | | GDF | 8 | 8 |
| | Protect glides | | GDT | 9 | 9 |
| Foam | Flame retardant foam | | FFR2 | • | • |
| | Flame retardant foam with fireproof fabric | | FFRF | 93 | 93 |
| Wood and wood-based materials | Raw material - EU Timber regulation | | EUTR | • | • |

Sample order DUO FRAME CHAIR 4L UPH (E-WK BS-CPC10 GD FFR2 EUTR)

③ – Please specify metal colour code – [see finishes](#)

⑤ – Please specify upholstery colour code from selected price group – [see finishes](#)

• Available as standard (included in basic price)

PRICE GROUP 2: Cura, Cura Loop, Valencia, Xtreme
PRICE GROUP 3: Silvertex, Step/Step Melange
PRICE GROUP 4: Blazer, Main Line Flax, Oceanic, skai Parotega, Synergy
PRICE GROUP 5: Remix 3
PRICE GROUP 6: Nappa leather

Finishes

Wood

Natural



SKNB
Natural
Beech

Stained



2.07Y
Black



2.06S
Slate



S39
Light Grey



2.09S
White



2.0CB
Acacia



SK40
Oak



2.0CC
Walnut

Metal



**NCS S
2005-Y60R**
Cashmere
NK



RAL 1024
Ochre Yellow
OY



**RAL 030
50 40**
Vermilion
Red
VR



RAL 6003
Olive Green
OG



RAL 5000
Violet Blue
VB



Chrome
CR



RAL 9006
White
Aluminium
WK



RAL 9005
Jet Black
BK

Plastic



KB
Black

General notes

All specified dimensions are approximate. Subject to minor modifications or differences for reasons of design improvements or for technical reasons.

- W = width
- D = depth
- H = height
- DI = diameter
- SH = seat height
- SH DIN = seat height measured acc. to DIN EN 1335-1

In compliance with the highest quality standards "Quality is irreplaceable." Guided by this principle, each product line is subjected to stringent quality testing.

Warranty

Manufacturer declares that the products shall be free from defects in material or workmanship. The warranty is given to the original purchaser only, for normal commercial usage. Detailed terms of warranty and warranty periods are available at <https://www.kusch.com/en/warranty>

paxo
price list
2026

Paxo

Design by Kusch + Co Designteam

Chair on 4 metal legs



PAXO FRAME CHAIR 4L P

Chair on sled metal frame



PAXO FRAME CHAIR CFS P

Price list

Paxo chair on 4 metal legs

Shell made of plastic.
4-leg frame made of powder-coated or chromium plated steel, stackable, plastic glides.



| PAXO FRAME CHAIR 4L P | PAXO FRAME CHAIR CFS P |
|---|---|
| W 510 mm D 550 mm H 820 mm SH 450 mm SH DIN 420 mm WT 5,5 kg | W 510 mm D 520 mm H 820 mm SH 450 mm SH DIN 435 mm WT 5,5 kg |

Basic price (EUR)

158

212

| | | | | | |
|--------------------------------------|---|-----------------|---------|----|-----|
| Frame | Steel | powder-coated | E-③ | • | • |
| | | chromium plated | E-CR | 20 | 40 |
| Shell | Plastic | | CC-④ | • | • |
| | None | | | • | • |
| Seat pad | Upholstered | Price group | SE-PD-⑤ | 2 | 51 |
| | | | | 3 | 58 |
| | | | | 4 | 67 |
| | | | | 5 | 72 |
| | | | | 6 | 134 |
| Linking element | None | | | • | • |
| | Extractable | | IN-CL | 51 | — |
| | Linking element for glides | | IN-GD | — | 13 |
| Glides | Plastic | | GD | • | • |
| | Plastic with felt | | GDF | 8 | 8 |
| | Protect glides | | GDT | 9 | — |
| Foam | Standard foam | | FSTD | — | • |
| | Flame retardant foam | | FFR2 | 8 | 8 |
| Wood and wood-based materials | Raw material from certified forests, FSC certificate – authorized companies | | FSC | — | • |
| Sample order | PAXO FRAME CHAIR 4L P (E-CR-RAL9005BK CC-KB GD) | | | | |

③ – Please specify metal code – [see finishes](#)

④ – Please specify plastic code – [see finishes](#)

⑤ – Please specify upholstery colour code from selected price group – [see finishes](#)

• Available as standard (included in basic price)

PRICE GROUP 2: Cura, Cura Loop, Valencia, Xtreme
PRICE GROUP 3: Silvertex, Step/Step Melange
PRICE GROUP 4: Blazer, Main Line Flax, Oceanic, skai Parotega, Synergy
PRICE GROUP 5: Remix 3
PRICE GROUP 6: Nappa leather

Finishes

Metal



**NCS S
2005-Y60R**
Cashmere
NK



RAL 1024
Ochre Yellow
OY



**RAL 030
50 40**
Vermilion
Red
VR



RAL 6003
Olive Green
OG



RAL 5000
Violet Blue
VB



Chrome
CR



RAL 9005
Jet Black
BK

Plastic



KB
Black



KS
Silver



KR
Reed Green

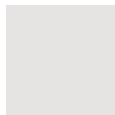

KWT
Traffic White

General notes

All specified dimensions are approximate. Subject to minor modifications or differences for reasons of design improvements or for technical reasons.

- W = width
- D = depth
- H = height
- DI = diameter
- SH = seat height
- SH DIN = seat height measured acc. to DIN EN 1335-1

In compliance with the highest quality standards "Quality is irreplaceable." Guided by this principle, each product line is subjected to stringent quality testing.

Only the products marked in this document are FSC® (FSC®-C120977).

Look for our FSC®-certified products. Sale of products that meet the FSC® requirements is possible only by Nowy Styl Sp. z o.o., Nowy Styl Nederland B.V. and Kusch + Co GmbH.



The mark of responsible forestry

The FSC® certificate applies to responsible forest management and the entire flow of raw materials from the forest to the customer. Each stage of the chain is monitored in terms of social, ecological and economic performance. The product with the FSC® label gives customers a guarantee that the wood used for the production of the product comes from sources managed in a sustainable manner.

Warranty

Manufacturer declares that the products shall be free from defects in material or workmanship. The warranty is given to the original purchaser only, for normal commercial usage. Detailed terms of warranty and warranty periods are available at <https://www.kusch.com/en/warranty>

luca price list 2026

Luca

Design by Robert de le Roi

Stool on 4 wooden legs



LUCA STOOL 4L
UPH

Chair on 4 wooden legs



LUCA FRAME
CHAIR 4L W



LUCA FRAME
CHAIR 4L
W/UPH



LUCA FRAME
CHAIR 4L UPH

Chair on 4 wooden legs with armrests



LUCA FRAME
CHAIR 4LA
W/UPH



LUCA FRAME
CHAIR 4LA
UPH



LUCA FRAME
CHAIR 4LA HB
UPH



LUCA FRAME
CHAIR
4LA HB W/UPH 2



LUCA FRAME
CHAIR
4LA HB UPH 2

Chair on 4 wooden legs with handle bar



LUCA FRAME CHAIR
4L HH UPH



LUCA FRAME CHAIR
4LA HH UPH

Price list

Luca stool on 4 wooden legs

Upholstered seat, standard foam.
Frame: 4 legs, made of solid beech wood, plastic glides.



LUCA STOOL 4L UPH

W 380 mm
D 380 mm
SH 450 mm
SH DIN 455 mm
WT 4 kg

Basic price (EUR) according to upholstery price group

| | | | | |
|-----------------------------------|---|---------|------|------|
| | Price group 2 | | | 213 |
| | Price group 3 | | | 218 |
| | Price group 4 | | | 225 |
| | Price group 5 | | | 230 |
| Frame | Solid beech wood | natural | E-① | • |
| | | stained | | 20 |
| Seat | Upholstered | | SE-⑤ | • |
| | Plastic | | GD | • |
| Glides | Plastic with felt | | GDF | 8 |
| | Protect glides | | GDT | 9 |
| Foam | Standard foam | | FSTD | • |
| | Flame retardant foam | | FFR2 | 6 |
| | Flame retardant foam with fireproof fabric | | FFRF | 33 |
| Wood certificate | Raw material from certified forests, FSC certificate – authorized companies | | FSC | • |
| Wooden elements lacquering | Water lacquer UV | | UV | • |
| | Water lacquer | | | - 20 |
| Sample order | LUCA STOOL 4L UPH (SE-CUR64195 GDF FSTD FSC UV) | | | |

① – Please specify wood colour code – [see finishes](#)

⑤ – Please specify upholstery colour code from selected price group – [see finishes](#)

• Available as standard (included in basic price)

Price list

Luca chair on 4 wooden legs

Seat made of beech plywood or upholstered.
 Backrest made of beech plywood or upholstered.
 Frame: 4 legs, made of solid beech wood, plastic glides. Stackable.
 Also available with upholstered seat and wooden backrest or upholstered seat and backrest.



| | | | LUCA FRAME CHAIR 4L W | LUCA FRAME CHAIR 4L W/UPH | LUCA FRAME CHAIR 4L UPH |
|-----------------------------------|---|---------|---|---|---|
| | | | W 490 mm D 530 mm H 850 mm SH 450 mm SH DIN 430 mm WT 5 kg | W 490 mm D 530 mm H 850 mm SH 450 mm SH DIN 440 mm WT 5 kg | W 490 mm D 530 mm H 850 mm SH 450 mm SH DIN 440 mm WT 5,5 kg |
| | | | Basic price (EUR) | Basic price (EUR) according to upholstery price group | |
| Price group 2 | | | 296 | 315 | 351 |
| Price group 3 | | | | 322 | 365 |
| Price group 4 | | | | 329 | 383 |
| Price group 5 | | | | 337 | 393 |
| Frame | Solid beech wood | natural | • | • | • |
| | | stained | 20 | 20 | 20 |
| Backrest | Beech in the colour of frame | | • | • | — |
| | Beech in the colour of frame | Slits | 25 | 25 | — |
| | Upholstered | | — | — | • |
| Seat | Beech in the colour of frame | | • | — | — |
| | Upholstered | | — | • | • |
| Glides | Plastic | | • | • | • |
| | Plastic with felt | | 8 | 8 | 8 |
| | Protect glides | | 9 | 9 | 9 |
| Foam | Standard foam | | — | • | • |
| | Flame retardant foam | | | 6 | 9 |
| | Flame retardant foam with fireproof fabric | | | 33 | 77 |
| Wood certificate | Raw material from certified forests, FSC certificate – authorized companies | | • | • | • |
| Wooden elements lacquering | Water lacquer UV | | • | • | • |
| | Water lacquer | | -40 | -28 | -20 |

Sample order LUCA FRAME CHAIR 4L W (E-SKNB BA-SKNB SE-SKNB GDF FSC UV)

① – Please specify wood colour code – [see finishes](#)

⑤ – Please specify upholstery colour code from selected price group – [see finishes](#)

• Available as standard (included in basic price)

Luca chair on 4 wooden legs, with armrests

Upholstered seat, backrest made of beech plywood or upholstered.
Frame: 4 legs and armrests made of solid beech wood, plastic glides. Stackable.



| LUCA FRAME CHAIR 4LA W/UPH | LUCA FRAME CHAIR 4LA UPH | LUCA FRAME CHAIR 4LA HB UPH |
|---|---|---|
| W 600 mm D 590 mm H 850 mm SH 450 mm SH DIN 440 mm WT 7,5 kg | W 600 mm D 590 mm H 850 mm SH 450 mm SH DIN 440 mm WT 8 kg | W 600 mm D 640 mm H 990 mm SH 450 mm SH DIN 440 mm WT 9 kg |

Basic price (EUR) according to upholstery price group

| | | | | 359 | 393 | 453 |
|-----------------------------------|---|---------|---------------------|-----|-----|-----|
| | Price group 2 | | | | | |
| | Price group 3 | | | 365 | 406 | 471 |
| | Price group 4 | | | 372 | 424 | 494 |
| | Price group 5 | | | 379 | 436 | 511 |
| Frame | Solid beech wood | natural | E- ^① | • | • | • |
| | | stained | | 20 | 20 | 20 |
| Backrest | Beech in the colour of frame | | BA- ^① | • | – | – |
| | Beech in the colour of frame | Slits | BA-DZ- ^① | 25 | – | – |
| | Upholstered | | BA- ^⑤ | – | • | • |
| Seat | Upholstered | | SE- ^⑤ | • | • | • |
| Glides | Plastic | | GD | • | • | • |
| | Plastic with felt | | GDF | 8 | 8 | 8 |
| | Protect glides | | GDT | 9 | 9 | 9 |
| Foam | Standard foam | | FSTD | • | • | • |
| | Flame retardant foam | | FFR2 | 6 | 9 | 13 |
| | Flame retardant foam with fireproof fabric | | FFRF | 33 | 77 | 130 |
| Wood certificate | Raw material from certified forests, FSC certificate – authorized companies | | FSC | • | • | • |
| Wooden elements lacquering | Water lacquer UV | | UV | • | • | • |
| | Water lacquer | | | –28 | –20 | –20 |

Sample order LUCA FRAME CHAIR 4LA W/UPH (E-SKNB BA-SKNB SE-CUR64195 GDF FSTD FSC UV)

^① – Please specify wood colour code – [see finishes](#)

^⑤ – Please specify upholstery colour code from selected price group – [see finishes](#)

• Available as standard (included in basic price)

PRICE GROUP 2: Cura, Cura Loop, Valencia, Xtreme
PRICE GROUP 3: Silvertex, Step/Step Melange
PRICE GROUP 4: Blazer, Main Line Flax, Oceanic, skai Parotega, Synergy
PRICE GROUP 5: Remix 3

Price list

Luca chair on 4 wooden legs, with handle bar

Upholstered seat, upholstered backrest with wooden handle bar (backrest crossbar).
Frame: 4 legs and armrests made of solid beech wood, plastic glides. Stackable.



LUCA FRAME CHAIR 4L HH UPH

W 600 mm
D 590 mm
H 850 mm
SH 450 mm
SH DIN 440 mm
WT 7,5 kg

LUCA FRAME CHAIR 4LA HH UPH

W 600 mm
D 590 mm
H 850 mm
SH 450 mm
SH DIN 440 mm
WT 8 kg

Basic price (EUR) according to upholstery price group

| | | | | 381 | 423 |
|-----------------------------------|---|---------|------------------|-----|-----|
| | Price group 2 | | | | |
| | Price group 3 | | | 391 | 436 |
| | Price group 4 | | | 410 | 453 |
| | Price group 5 | | | 423 | 467 |
| Frame | Solid beech wood | natural | E- ^① | • | • |
| | | stained | | 20 | 20 |
| Backrest | Upholstered | | BA- ^⑤ | • | • |
| Seat | Upholstered | | SE- ^⑤ | • | • |
| Glides | Plastic | | GD | • | • |
| | Plastic with felt | | GDF | 8 | 8 |
| | Protect glides | | GDT | 9 | 9 |
| Foam | Standard foam | | FSTD | • | • |
| | Flame retardant foam | | FFR2 | 9 | 9 |
| | Flame retardant foam with fireproof fabric | | FFRF | 77 | 77 |
| Wood certificate | Raw material from certified forests, FSC certificate – authorized companies | | FSC | • | • |
| Wooden elements lacquering | Water lacquer UV | | UV | • | • |
| | Water lacquer | | | -20 | -20 |

Sample order LUCA FRAME CHAIR 4LA HH UPH (E-SKNB BA-CPC10 SE-CUR64195 GDF FSTD FSC UV)

^① – Please specify wood colour code – [see finishes](#)

^⑤ – Please specify upholstery colour code from selected price group – [see finishes](#)

- Available as standard (included in basic price)

PRICE GROUP 2: Cura, Cura Loop, Valencia, Xtreme

PRICE GROUP 3: Silvertex, Step/Step Melange

PRICE GROUP 4: Blazer, Main Line Flax, Oceanic, skai Parotega, Synergy

PRICE GROUP 5: Remix 3

Luca chair on 4 wooden legs with armrests

Upholstered seat, backrest made of beech plywood or upholstered.
Frame: 4 legs and armrests made of solid beech wood, plastic glides.



| LUCA FRAME CHAIR 4LA HB W/UPH 2 | LUCA FRAME CHAIR 4LA HB UPH 2 |
|---|---|
| W 560 mm D 560 mm H 930 mm SH 450 mm SH DIN 440 mm WT 7,5 kg | W 560 mm D 560 mm H 930 mm SH 450 mm SH DIN 440 mm WT 7,5 kg |

Basic price (EUR) according to upholstery price group

| | | | | 369 | 424 |
|-----------------------------------|---|-----------------------|--------------|-----|-----|
| | Price group 2 | | | | |
| | Price group 3 | | | 376 | 434 |
| | Price group 4 | | | 386 | 447 |
| | Price group 5 | | | 391 | 456 |
| Frame | Solid beech wood | natural | E-① | • | • |
| | | stained | | 20 | 20 |
| Backrest | Beech in the colour of frame | | BA-① | • | — |
| | | Slits | BA-DZ-① | 25 | — |
| | | Upholstered pad | BA-PD-①/⑤ | — | • |
| | | Slits Upholstered pad | BA-DZ-PD-①/⑤ | — | 25 |
| Seat | Upholstered | | SE-⑤ | • | • |
| Glides | Plastic | | GD | • | • |
| | Plastic with felt | | GDF | 8 | 8 |
| | Protect glides | | GDT | 9 | 9 |
| Foam | Standard foam | | FSTD | • | • |
| | Flame retardant foam | | FFR2 | 6 | 13 |
| | Flame retardant foam with fireproof fabric | | FFRF | 33 | 54 |
| Wood certificate | Raw material from certified forests, FSC certificate – authorized companies | | FSC | • | • |
| Wooden elements lacquering | Water lacquer UV | | UV | • | • |
| | Water lacquer | | | -28 | -20 |

Sample order LUCA FRAME CHAIR 4LA HB W/UPH 2 (E-SKNB BA-SKNB SE-CUR64195 GDF FSTD FSC UV)

① – Please specify wood colour code – [see finishes](#)

⑤ – Please specify upholstery colour code from selected price group – [see finishes](#)

• Available as standard (included in basic price)

PRICE GROUP 2: Cura, Cura Loop, Valencia, Xtreme
PRICE GROUP 3: Silvertex, Step/Step Melange
PRICE GROUP 4: Blazer, Main Line Flax, Oceanic, skai Parotega, Synergy
PRICE GROUP 5: Remix 3

Finishes

Wood

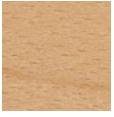

SKNB
Natural
beech



2.0CC
Walnut



2.0CB
Acacia

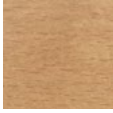

SK40
Oak



2.07Y
Black



2.06S
Slate

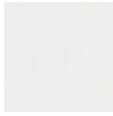

2.09S
White



SS39
Light grey

General notes

All specified dimensions are approximate. Subject to minor modifications or differences for reasons of design improvements or for technical reasons.

- W = width
- D = depth
- H = height
- DI = diameter
- SH = seat height
- SH DIN = seat height measured acc. to DIN EN 1335-1

In compliance with the highest quality standards "Quality is irreplaceable." Guided by this principle, each product line is subjected to stringent quality testing.

Only the products marked in this document are FSC® (FSC®-C120977).

Look for our FSC®-certified products. Sale of products that meet the FSC® requirements is possible only by Nowy Styl Sp. z o.o., Nowy Styl Nederland B.V. and Kusch + Co GmbH.



The mark of responsible forestry

The FSC® certificate applies to responsible forest management and the entire flow of raw materials from the forest to the customer. Each stage of the chain is monitored in terms of social, ecological and economic performance. The product with the FSC® label gives customers a guarantee that the wood used for the production of the product comes from sources managed in a sustainable manner.

Warranty

Manufacturer declares that the products shall be free from defects in material or workmanship. The warranty is given to the original purchaser only, for normal commercial usage.

Detailed terms of warranty and warranty periods are available at

<https://www.kusch.com/en/warranty>

kanu price list 2026

Kanu

Design: Tomasz Augustyniak

Lounge armchair LGM



KANU ARMCHAIR ARC 4L LGM



KANU ARMCHAIR 4L LGM

Lounge armchair LGW



KANU ARMCHAIR ARC 4L LGW



KANU ARMCHAIR 4L LGW

Lounge table



KANU TABLE LOUNGE 35



KANU TABLE LOUNGE 50

Price list

Kanu armchair lounge LGM

Backrest and seat made of beech plywood.
Frame made of steel, powder-coated, plastic glides.



| | |
|---|---|
| Kanu armchair lounge ARC 4L LGM | Kanu armchair lounge 4L LGM |
| KANU ARMCHAIR ARC 4L LGM | KANU ARMCHAIR 4L LGM |
| W 750 mm D 685 mm H 800 mm SH 410 mm WT 10,1 kg | W 750 mm D 685 mm H 800 mm SH 410 mm WT 10,3 kg |
| Basic price (EUR) | |
| 370 | 370 |

| | | | | | | | | | | | | |
|--------------------------------------|---|--------------|-----------------|------------------|---------------------|---|---|-----|-----|-----|-----|-----|
| Frame | Powder-coated steel | | E- ^③ | | • | | | • | | | | |
| Backrest and seat | Beech plywood | natural | | | • | | | • | | | | |
| | | stained | | BS- ^① | 15 | | | 15 | | | | |
| | | veneered | | | 90 | | | 90 | | | | |
| Backrest pad | None Upholstered (upholstery type and colour is the same for seat and backrest) | Price group: | | | • | • | – | • | • | – | | |
| | | | 2 | | | | | 60 | | 60 | | |
| | | | 3 | | | | | 70 | | 70 | | |
| | | | 4 | | BA-PD- ^⑤ | – | – | 75 | – | – | 75 | |
| | | | 5 | | | | | 80 | | 80 | | |
| | | | 6 | | | | | 155 | | 155 | | |
| Seat pad | None Upholstered (upholstery type and colour is the same for seat and backrest) | Price group: | | | • | • | – | • | • | – | | |
| | | | 2 | | | | | 65 | 65 | | 65 | 65 |
| | | | 3 | | | | | 75 | 75 | | 75 | 75 |
| | | | 4 | | SE-PD- ^⑤ | – | – | 80 | 80 | – | 80 | 80 |
| | | | 5 | | | | | 85 | 85 | | 85 | 85 |
| | | | 6 | | | | | 165 | 165 | | 165 | 165 |
| Glides | Plastic | | GD | | • | | | • | | | | |
| | Plastic with felt | | GDF | | ○ | | | ○ | | | | |
| Foam | Flame retardant | | FFR2 | | – | • | • | – | • | • | | |
| Wood and wood-based materials | Raw material from certified forests, FSC certificate – authorized companies | | FSC | | • | | | • | | | | |
| Assembly | Assembled, cardboard packaging | | PACK-ASM | | • | | | • | | | | |
| Sample order | KANU ARMCHAIR ARC 4L LGM (E-BL BS-SKNB GD FSC PACK-ASM) | | | | | | | | | | | |

① – Please specify wood colour code – [see finishes](#)

③ – Please specify metal colour code – [see finishes](#)

⑤ – Please specify upholstery colour code from selected price group – [see finishes](#)

• Available as standard (included in basic price)

○ Available as an option (included in basic price)

PRICE GROUP 2: Boogie, Cura, Cura Loop, Home, Urban, Valencia, Xtreme
PRICE GROUP 3: Chili, Moulin-Fr, Silvertex, Step/Step Melange
PRICE GROUP 4: Blazer, Focus Royal, Main Line Flax, Oceanic, skai Parotega, Synergy
PRICE GROUP 5: Remix 3
PRICE GROUP 6: Nappa leather

Price list

Kanu armchair lounge LGW

Backrest and seat made of beech plywood.
Frame made of beech plywood, stained in black colour, plastic glides.



| | | | | Kanu armchair lounge ARC 4L LGW | | | Kanu armchair lounge ARC 4L LGW | | | | |
|--------------------------------------|---|--------------|---------|--|---|---|--|-----|---|-----|-----|
| | | | | KANU ARMCHAIR ARC 4L LGW | | | KANU ARMCHAIR 4L LGW | | | | |
| | | | | W 750 mm D 680 mm H 800 mm SH 410 mm WT 9,7 kg | | | W 750 mm D 680 mm H 800 mm SH 410 mm WT 9,9 kg | | | | |
| | | | | Basic price (EUR) | | | | | | | |
| | | | | 600 | | | 600 | | | | |
| Frame | Stained beech plywood, black | E-2.07Y | | • | | | • | | | | |
| Backrest and seat | Beech plywood | natural | BS-① | • | | | • | | | | |
| | | stained | | 15 | | | 15 | | | | |
| | | veneered | | 90 | | | 90 | | | | |
| Backrest pad | (upholstery type and colour is the same for seat and backrest) | Price group: | BA-PD-⑤ | None | • | • | – | • | • | – | |
| | | | | 2 | | | 60 | | | 60 | |
| | | | | 3 | | | 70 | | | 70 | |
| | | | | 4 | – | – | 75 | – | – | 75 | |
| | | | | 5 | | | 80 | | | 80 | |
| | | | | 6 | | | 155 | | | 155 | |
| Seat pad | (upholstery type and colour is the same for seat and backrest) | Price group: | SE-PD-⑤ | None | • | • | – | • | • | – | |
| | | | | 2 | | | 65 | 65 | | 65 | 65 |
| | | | | 3 | | | 75 | 75 | | 75 | 75 |
| | | | | 4 | – | | 80 | 80 | – | 80 | 80 |
| | | | | 5 | | | 85 | 85 | | 85 | 85 |
| | | | | 6 | | | 165 | 165 | | 165 | 165 |
| Glides | Plastic | GD | | • | | | • | | | | |
| | Plastic with felt | GDF | | ◦ | | | ◦ | | | | |
| Foam | Flame retardant | FFR2 | | – | • | • | – | • | • | | |
| Wood and wood-based materials | Raw material from certified forests, FSC certificate – authorized companies | FSC | | • | | | • | | | | |
| Assembly | Assembled, cardboard packaging | PACK-ASM | | • | | | • | | | | |
| Sample order | KANU ARMCHAIR ARC 4L LGW (E-2.07Y BS-SKNB GD FSC PACK-ASM) | | | | | | | | | | |

① – Please specify wood colour code – [see finishes](#)

⑤ – Please specify upholstery colour code from selected price group – [see finishes](#)

• Available as standard (included in basic price)

◦ Available as an option (included in basic price)

PRICE GROUP 2: Boogie, Cura, Cura Loop, Home, Urban, Valencia, Xtreme
PRICE GROUP 3: Chili, Moulin-Fr, Silvertex, Step/Step Melange
PRICE GROUP 4: Blazer, Focus Royal, Main Line Flax, Oceanic, skai Parotega, Synergy
PRICE GROUP 5: Remix 3
PRICE GROUP 6: Nappa leather

Kanu lounge 35 table

Round table top.

Table top thickness 18 mm for melamine (MFC) finish, table top height 350 mm. Table top thickness 21 mm for laminate finish, table top height 353 mm. Table top thickness 14 mm for Fenix NTM finish, table top height 346 mm.

Base – A-leg frame, made of beech plywood, stained in black colour, plastic glides.



Kanu lounge 35 table

KANU TABLE LOUNGE 35

| | |
|---------|-----|
| WT (kg) | 8,7 |
|---------|-----|

| | | |
|-------------------------|-------|--|
| Table top diameter (mm) | DI700 | 700 |
| | | Basic price (EUR) according to table top finishes |
| Melamine (MFC) | | 350 |
| Laminate | | 520 |
| Fenix NTM® | | 605 |

| | | | | | |
|--------------------------------------|---|-------|---|---|---|
| Table top finish | Melamine (MFC) | Edge: | 2 mm (in table top colour) | | |
| | Laminate | Edge: | 2 mm (in table top colour) | ① | • |
| | Fenix NTM® | Edge: | without edge (visible plywood structure) | | |
| Base finish | Stained beech plywood, black colour | | BC-2.07Y | | • |
| Glides | Plastic | | GD | | • |
| | Plastic with felt | | GDF | | ○ |
| Wood and wood-based materials | Raw material – EU Timber regulation | | EUTR | | • |
| Assembly | Assembled, cardboard packaging | | PACK-ASM | | • |
| Sample order | KANU TABLE LOUNGE 35 (DI700 BI BC-2.07Y GD EUTR PACK-ASM) | | | | |

① – Please specify table top colour code – [see finishes](#)

- Available as standard (included in basic price)
- Available as an option (included in basic price)

Price list

Kanu lounge 50 table

Round table top.
 Table top thickness 18 mm for melamine (MFC) finish, table top height 500 mm. Table top thickness 21 mm for laminate finish, table top height 503 mm. Table top thickness 14 mm for Fenix NTM finish, table top height 496 mm.
 Base – A-leg frame, made of beech plywood, stained in black colour, plastic glides.



Kanu lounge 50 table

KANU TABLE LOUNGE 50

| | |
|---------|-----|
| WT (kg) | 9,4 |
|---------|-----|

| | | |
|-------------------------|-------|--|
| Table top diameter (mm) | DI700 | 700 |
| | | Basic price (EUR) according to table top finishes |
| Melamine (MFC) | | 370 |
| Laminate | | 540 |
| Fenix NTM® | | 625 |

| | | | | |
|--------------------------------------|-------------------------------------|--|---|---|
| Table top finish | Melamine (MFC) | Edge: 2 mm (in table top colour) | | |
| | Laminate | Edge: 2 mm (in table top colour) | ① | • |
| | Fenix NTM® | Edge: without edge (visible plywood structure) | | |
| Base finish | Stained beech plywood, black colour | BC-2.07Y | | • |
| Glides | Plastic | GD | | • |
| | Plastic with felt | GDF | | ○ |
| Wood and wood-based materials | Raw material – EU Timber regulation | EUTR | | • |
| Assembly | Assembled, cardboard packaging | PACK-ASM | | • |

Sample order KANU TABLE LOUNGE 50 (DI700 BI BC-2.07Y GD EUTR PACK-ASM)

① – Please specify table top colour code – [see finishes](#)

- Available as standard (included in basic price)
- Available as an option (included in basic price)

Finishes

Armchair

Wood

for seat and backrest

Natural



SKNB
Natural
Beech

Stained



2.07Y
Black



2.06S
Slate



S39
Light Grey

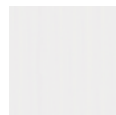

2.09S
White



2.0CB
Acacia



SK40
Oak



2.0CC
Walnut

for frame

Stained



2.07Y
Black

Veneer



SKNO
Natural Oak

Metal



**NCS S
2005-Y60R**
Cashmere
NK



RAL 1024
Ochre Yellow
OY



**RAL 030 50
40**
Vermilion Red
VR



RAL 6003
Olive Green
OG



RAL 5000
Violet Blue
VB



RAL 9005
Jet Black
BL

Finishes

Tables

Melamine (MFC)



Laminate

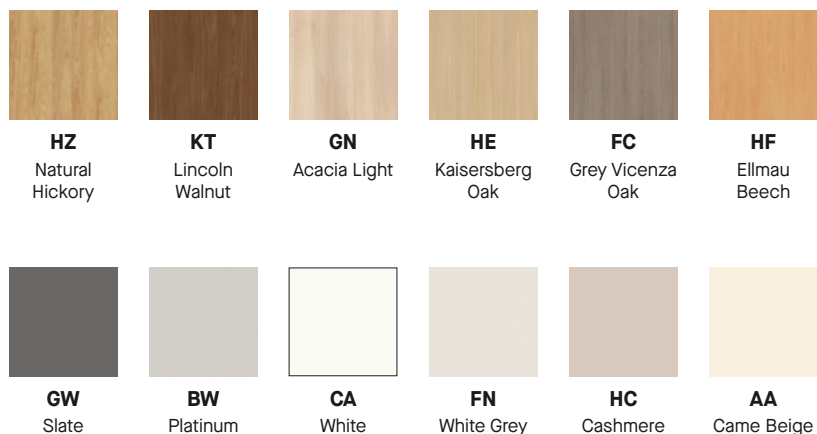

Fenix NTM®

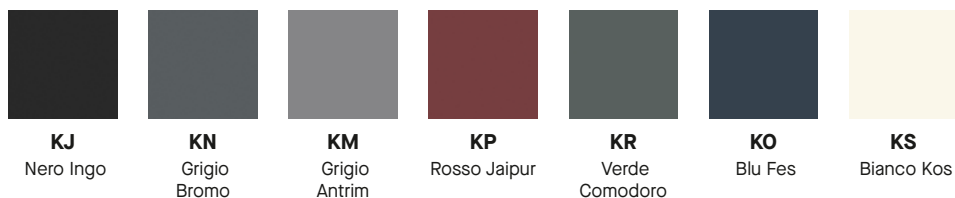

Wood

for base

Stained



General notes

All specified dimensions are approximate. Subject to minor modifications or differences for reasons of design improvements or for technical reasons.

- W = width
- D = depth
- H = height
- DI = diameter
- SH = seat height
- SH DIN = seat height measured acc. to DIN EN 1335-1

In compliance with the highest quality standards "Quality is irreplaceable." Guided by this principle, each product line is subjected to stringent quality testing.

Only the products marked in this document are FSC® (FSC®-C120977).

Look for our FSC®-certified products. Sale of products that meet the FSC® requirements is possible only by Nowy Styl Sp. z o.o., Nowy Styl Nederland B.V. and Kusch + Co GmbH.



The mark of responsible forestry

The FSC® certificate applies to responsible forest management and the entire flow of raw materials from the forest to the customer. Each stage of the chain is monitored in terms of social, ecological and economic performance. The product with the FSC® label gives customers a guarantee that the wood used for the production of the product comes from sources managed in a sustainable manner.

Warranty

Manufacturer declares that the products shall be free from defects in material or workmanship. The warranty is given to the original purchaser only, for normal commercial usage.

Detailed terms of warranty and warranty periods are available at

<https://www.kusch.com/en/warranty>

uni_verso price list 2026

uni_verso

Design by Norbert Geelen

Chair on 4 metal legs, plastic shell



UNIVERSO FRAME
CHAIR 4L P



UNIVERSO FRAME
CHAIR 4LA P



UNIVERSO FRAME
CHAIR HKR 4L P

2, 3, 4, 5, 6-seater bench, plastic shell



UNIVERSO BENCH
2U 4L P



UNIVERSO BENCH
3U 4L P



UNIVERSO BENCH
4U 4L P



UNIVERSO BENCH
5U 4L P



UNIVERSO BENCH
6U 4L P

Chair/hocker on 4 wooden legs, plastic shell



UNIVERSO FRAME
CHAIR 4L LWM P



UNIVERSO FRAME
CHAIR HKR 4L LWM P

Chair on 4 metal legs, plywood shell



UNIVERSO FRAME
CHAIR 4L W



UNIVERSO FRAME
CHAIR 4LA W

Chair on 4 metal legs, fully upholstered shell



UNIVERSO FRAME
CHAIR 4L UPH



UNIVERSO FRAME
CHAIR 4LA UPH

Chair on 4 metal legs, fully upholstered shell with high backrest



**UNIVERSO FRAME
CHAIR 4L HB UPH**



**UNIVERSO FRAME
CHAIR 4LA HB UPH**

Chair on sled metal frame



**UNIVERSO FRAME
CHAIR CFS P**



**UNIVERSO FRAME
CHAIR CFS W**

Chair on sled metal frame, fully upholstered shell



**UNIVERSO FRAME
CHAIR CFS UPH**

Hocker chair on 4 metal/wooden legs, upholstered shell



**UNIVERSO FRAME
CHAIR HKR 4L LB UPH**



**UNIVERSO FRAME
CHAIR HKR 4L LB LWM UPH**

Swivel chair



**UNIVERSO SWIVEL CHAIR
HB UPH**

Price list

uni_verso chair on 4 metal legs, plastic shell

Shell made of plastic.
4 leg frame made of powder-coated or chromed steel,
with or without armrests, stackable, plastic glides.



| | | | | UNIVERSO FRAME CHAIR 4L P | | | | UNIVERSO FRAME CHAIR 4LA P | | | |
|--------------------------------------|---|-------------|---------|---|-----------|----|----|---|----|-----|-----|
| | | | | W 540 mm D 520 mm H 820 mm SH 450 mm SH DIN 425 mm WT 5,5 kg | | | | W 610 mm D 520 mm H 820 mm SH 450 mm SH DIN 425 mm WT 6,5 kg | | | |
| | | | | Basic price (EUR) | | | | | | | |
| | | | | 232 | | | | 343 | | | |
| Seat height | 450 mm | | SH450 | • | | | | • | | | |
| | 500 mm | | SH500 | 45 | | | | 45 | | | |
| Frame | Powder-coated | | E-(3) | • | | | | • | | | |
| | Chrom | | | 19 | | | | 19 | | | |
| | Satin chrome (for SH450) | | E-(3) | 23 | | | | 48 | | | |
| Shell | Plastic | | CC-(4) | • | | | | • | | | |
| Backrest pad | No backrest pad | | | • | • | – | • | • | – | | |
| | Upholstered backrest pad | Price group | | | | | 72 | | 72 | | |
| | | | 2 | | | | 77 | | 77 | | |
| | | | 3 | | | | 87 | – | – | 87 | |
| | | | 4 | | BA-PD-(5) | – | – | | | 93 | |
| | | | 5 | | | | | | | 129 | |
| 6 | | | | | | | | 129 | | | |
| Seat pad | No seat pad | | | • | – | – | • | – | – | | |
| | Upholstered seat pad | Price group | | | | | 77 | 77 | 77 | 77 | |
| | | | 2 | | | | 85 | 85 | 85 | 85 | |
| | | | 3 | | | | 94 | 94 | – | 94 | 94 |
| | | | 4 | | SE-PD-(5) | – | | | | 100 | 100 |
| | | | 5 | | | | | | | 155 | 155 |
| 6 | | | | | | | | 155 | | | |
| Armrests | None | | | • | | | | – | | | |
| | Plastic armrests | | ARM-(4) | 48 | | | | – | | | |
| | Black plastic armpads | | AP-KB | – | | | | • | | | |
| Glides | Plastic | | GD | • | | | | • | | | |
| | Plastic with felt | | GDF | 8 | | | | 8 | | | |
| | Protect glides | | GDT | 9 | | | | 9 | | | |
| Foam | Flame retardant foam | | FFR2 | – | • | • | – | • | • | | |
| | Flame retardant foam with fireproof fabric | | FFRF | – | 33 | 60 | – | 33 | 60 | | |
| Wood and wood-based materials | Raw material from certified forests, FSC certificate – authorized companies | | FSC | – | • | • | – | • | • | | |
| Sample order | UNIVERSO FRAME CHAIR 4L P (SH450 E-WS CC-KO) | | | | | | | | | | |

(3) – Please specify metal colour code – [see finishes](#)

(4) – Please specify plastic colour code – [see finishes](#)

(5) – Please specify upholstery colour code from selected price group – [see finishes](#)

• Available as standard (included in basic price)

PRICE GROUP 2: Cura, Cura Loop, Valencia, Xtreme.
PRICE GROUP 3: Silvertex, Step/Step Melange,
PRICE GROUP 4: Blazer, Main Line Flax, Oceanic, skai Parotega, Synergy
PRICE GROUP 5: Remix 3
PRICE GROUP 6: Nappa leather

uni_verso hocker chair on 4 metal legs, plastic shell

Shell made of plastic.
 4 leg hocker frame made of chromed steel, plastic glides.
 Footrest made of chrome-plated steel.



UNIVERSO FRAME CHAIR HKR 4L P

W 480 mm
 D 560 mm
 H 1170 mm
 SH 800 mm
 SH DIN 780 mm
 WT 7,5 kg

Basic price (EUR)

499

| | | | | | | | | |
|--------------------------------------|---|-------------|---------------------|---|---|----|-----|-----|
| Frame | Chrom | | E- ^③ | | • | | | |
| Shell | Plastic | | CC- ^④ | | • | | | |
| | No backrest pad | | | | • | • | – | |
| Backrest pad | Upholstered backrest pad | Price group | BA-PD- ^⑤ | 2 | | | 72 | |
| | | | | 3 | | | 77 | |
| | | | | 4 | – | – | 87 | |
| | | | | 5 | | | 93 | |
| | | | | 6 | | | 129 | |
| | No seat pad | | | | • | – | – | |
| Seat pad | Upholstered seat pad | Price group | SE-PD- ^⑤ | 2 | | | 77 | 77 |
| | | | | 3 | | | 85 | 85 |
| | | | | 4 | – | – | 94 | 94 |
| | | | | 5 | | | 100 | 100 |
| | | | | 6 | | | 155 | 155 |
| Glides | Plastic | | GD | | • | | | |
| | Plastic with felt | | GDF | | | 8 | | |
| Foam | Flame retardant foam | | FFR2 | | | • | • | |
| | Flame retardant foam with fireproof fabric | | FFRF | | | 33 | 60 | |
| Wood and wood-based materials | Raw material from certified forests, FSC certificate – authorized companies | | FSC | | – | • | • | |

Sample order UNIVERSO FRAME CHAIR HKR 4L P (E-CR CC-KO GD)

- ③ – Please specify metal colour code – [see finishes](#)
- ④ – Please specify plastic colour code – [see finishes](#)
- ⑤ – Please specify upholstery colour code from selected price group – [see finishes](#)
- Available as standard (included in basic price)

PRICE GROUP 2: Cura, Cura Loop, Valencia, Xtreme,
 PRICE GROUP 3: Silvertex, Step/Step Melange,
 PRICE GROUP 4: Blazer, Main Line Flax, Oceanic, skai Parotega, Synergy
 PRICE GROUP 5: Remix 3
 PRICE GROUP 6: Nappa leather

Price list

uni_verso 2-seater bench, plastic shell

Shell made of plastic.
Legs made of powder-coated or polished aluminium, beam powder-coated, with or without armrests, plastic glides.



UNIVERSO BENCH 2U 4L P

W 1080 mm
D 540 mm
H 820 mm
SH 450 mm
SH DIN 425 mm
WT 15 kg

Basic price (EUR)

877

| | Beam | Legs | | | | | | | | |
|--------------------------|--------------------------|--|---------------|------------|--|--|-----|-----|-----|-----|
| Frame | Powder-coated | Powder-coated | E-(3)/(3) | | | | | • | | |
| | | Aluminium polished | | | | | | 47 | | |
| Shell | Plastic | | CC-(4) | | | | | • | | |
| Backrest pad | No backrest pad | | | | | | | • | | |
| | Upholstered backrest pad | Price group | 2 | BA-PD-(5) | | | | | — | |
| | | | 3 | | | | | | 144 | |
| | | | 4 | | | | | | 154 | |
| | | | 5 | | | | | | 174 | |
| | | | 6 | | | | | | 186 | |
| Upholstered backrest pad | 6 | | | | | | 258 | | | |
| Seat pad | No seat pad | | | | | | | • | | |
| | Upholstered seat pad | Price group | 2 | SE-PD-(5) | | | | | — | |
| | | | 3 | | | | | | 154 | 154 |
| | | | 4 | | | | | | 170 | 170 |
| | | | 5 | | | | | | 188 | 188 |
| | | | 6 | | | | | | 200 | 200 |
| Upholstered seat pad | 6 | | | | | | 310 | 310 | | |
| Armrests | No armrests | | | GD | | | | • | | |
| | External | One armrest – available only with seat-replacing top on the edge of bench | Powder-coated | ARM-EX-(3) | | | | | 98 | |
| | | Two armrests on both sides of bench – not available with seat-replacing top on the edge of bench | Powder-coated | | | | | | 195 | |

(3) – Please specify metal colour code – [see finishes](#)

(4) – Please specify plastic colour code – [see finishes](#)

(5) – Please specify upholstery colour code from selected price group – [see finishes](#)

• Available as standard (included in basic price)

PRICE GROUP 2: Cura, Cura Loop, Valencia, Xtreme.

PRICE GROUP 3: Silvertex, Step/Step Melange,

PRICE GROUP 4: Blazer, Main Line Flax, Oceanic, skai Parotega, Synergy

PRICE GROUP 5: Remix 3

PRICE GROUP 6: Nappa leather

| | | | | | UNIVERSO BENCH 2U 4L P | | | |
|--------------------------------------|---|---|---------------------|------------------------|------------------------|-----|----|-------|
| | No top | | | | | | • | |
| | Top position (7) | Top finish (1) | Frame finish (3) | Price group | | | | |
| Seat-replacing top* | A or B | Compact Laminate U0901TP Traceless Black | Powder-coated | 2 | TF-(7)-(1)/(3) | 133 | 64 | - 5 |
| | | | | 3 | | | 55 | - 20 |
| | | | | 4 | | | 47 | - 40 |
| | | | | 5 | | | 38 | - 52 |
| | | | | 6 | | | 20 | - 150 |
| | | | | | | | | |
| Glides | Plastic | | | GD | | | • | |
| | Plastic nonskid | | | GDN | | | 8 | |
| | Plastic with felt | | | GDF | | | 6 | |
| Foam | Flame retardant foam | | | FFR2 | | | • | • |
| | Flame retardant foam with fireproof fabric | | | FFRF | — | | 65 | 119 |
| | | | | FSC | — | | • | • |
| Wood and wood-based materials | Raw material from certified forests, FSC certificate – authorized companies | | | for version with a top | FSCMIX | | • | |
| Sample order | UNIVERSO BENCH 2U 4L P (E-BK/BK CC-KO GD) | | | | | | | |

*rectangular top instead of seat, 500 × 400 mm, thickness 13 mm

① – Please specify wood colour code – [see finishes](#)

③ – Please specify metal colour code – [see finishes](#)

⑦ – Please specify seat-replacing top position

• Available as standard (included in basic price)

PRICE GROUP 2: Cura, Cura Loop, Valencia, Xtreme,
PRICE GROUP 3: Silvertex, Step/Step Melange,
PRICE GROUP 4: Blazer, Main Line Flax, Oceanic, skai Parotega, Synergy
PRICE GROUP 5: Remix 3
PRICE GROUP 6: Nappa leather

Price list

uni_verso 3-seater bench, plastic shell.

Shell made of plastic.
Legs made of powder-coated or polished aluminium, beam powder-coated, with or without armrests, plastic glides.

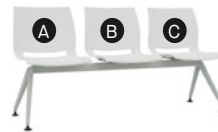

UNIVERSO BENCH 3U 4L P

W 1640 mm
D 540 mm
H 820 mm
SH 450 mm
SH DIN 425 mm
WT 19 kg

Basic price (EUR)

1141

| | Beam | Legs | | | | | | | | |
|---------------------|--------------------------|--|---------------|------------|--|--|--|-----|-----|-----|
| Frame | Powder-coated | Powder-coated | E-(3)/(3) | | | | | • | | |
| | | Aluminium polished | | | | | | 47 | | |
| Shell | Plastic | | CC-(4) | | | | | • | | |
| Backrest pad | No backrest pad | | | | | | | • | | |
| | Upholstered backrest pad | Price group | 2 | BA-PD-(5) | | | | | – | |
| | | | 3 | | | | | | 216 | |
| | | | 4 | | | | | | 231 | |
| | | | 5 | | | | | | 261 | |
| | | | 6 | | | | | | 279 | |
| 6 | 387 | | | | | | | | | |
| Seat pad | No seat pad | | | | | | | • | | |
| | Upholstered seat pad | Price group | 2 | SE-PD-(5) | | | | | – | |
| | | | 3 | | | | | | 231 | 231 |
| | | | 4 | | | | | | 255 | 255 |
| | | | 5 | | | | | | 282 | 282 |
| | | | 6 | | | | | | 300 | 300 |
| 6 | 465 | 465 | | | | | | | | |
| Armrests | No armrests | | | GD | | | | • | | |
| | External | One armrest – available only with seat-replacing top on the edge of bench | Powder-coated | ARM-EX-(3) | | | | 98 | | |
| | | Two armrests on both sides of bench – not available with seat-replacing top on the edge of bench | Powder-coated | | | | | 195 | | |

(3) – Please specify metal colour code – [see finishes](#)

(4) – Please specify plastic colour code – [see finishes](#)

(5) – Please specify upholstery colour code from selected price group – [see finishes](#)

• Available as standard (included in basic price)

PRICE GROUP 2: Cura, Cura Loop, Valencia, Xtreme.
PRICE GROUP 3: Silvertex, Step/Step Melange,
PRICE GROUP 4: Blazer, Main Line Flax, Oceanic, skai Parotega, Synergy
PRICE GROUP 5: Remix 3
PRICE GROUP 6: Nappa leather

| | | | | | UNIVERSO BENCH 3U 4L P | | | |
|---|---|---|---------------------|------------------------|------------------------|-----|----|-------|
| | No top | | | | | | • | |
| | Top position (7) | Top finish (1) | Frame finish (3) | Price group | | | | |
| Seat-replacing top* | A,B or C | Compact Laminate U0901TP Traceless Black | Powder-coated | 2 | TF-(7)-(1)/(3) | 133 | 64 | - 5 |
| | | | | 3 | | | 55 | - 20 |
| | | | | 4 | | | 47 | - 40 |
| | | | | 5 | | | 38 | - 52 |
| | | | | 6 | | | 20 | - 150 |
| | | | | | | | | |
| Glides | Plastic | | | GD | | | • | |
| | Plastic nonskid | | | GDN | | | 8 | |
| | Plastic with felt | | | GDF | | | 6 | |
| Foam | Flame retardant foam | | | FFR2 | | | • | • |
| | Flame retardant foam with fireproof fabric | | | FFRF | — | | 97 | 179 |
| Wood and wood-based materials | Raw material from certified forests, FSC certificate – authorized companies | | | | | | • | • |
| | | | | for version with a top | FSCMIX | — | | • |
| Sample order UNIVERSO BENCH 3U 4L P (E-BK/BK CC-KO GD) | | | | | | | | |

*rectangular top instead of seat, 500 × 400 mm, thickness 13 mm

① – Please specify wood colour code – [see finishes](#)

③ – Please specify metal colour code – [see finishes](#)

⑦ – Please specify seat-replacing top position

• Available as standard (included in basic price)

PRICE GROUP 2: Cura, Cura Loop, Valencia, Xtreme,
PRICE GROUP 3: Silvertex, Step/Step Melange,
PRICE GROUP 4: Blazer, Main Line Flax, Oceanic, skai Parotega, Synergy
PRICE GROUP 5: Remix 3
PRICE GROUP 6: Nappa leather

Price list

uni_verso 4-seater bench, plastic shell.

Shell made of plastic.
Legs made of powder-coated or polished aluminium,
beam powder-coated, with or without armrests, plastic glides.

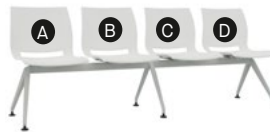

UNIVERSO BENCH 4U 4L P

W 2200 mm
D 540 mm
H 820 mm
SH 450 mm
SH DIN 425 mm
WT 30 kg

Basic price (EUR)

1633

| | Beam | Legs | | | | | | | | | |
|---------------------|--------------------------|--|-----------|---------------|------------|--|--|----|---|---|-----|
| Frame | Powder-coated | Powder-coated | E-(3)/(3) | | | | | • | | | |
| | | Aluminium polished | | | | | | 96 | | | |
| Shell | Plastic | | CC-(4) | | | | | • | | | |
| Backrest pad | No backrest pad | | | | | | | • | • | – | |
| | Upholstered backrest pad | Price group | 2 | BA-PD-(5) | | | | | | | 288 |
| | | | 3 | | | | | | | | 308 |
| | | | 4 | | | | | | | | 348 |
| | | | 5 | | | | | | | | 372 |
| | | | 6 | | | | | | | | 516 |
| Seat pad | No seat pad | | | | | | | • | – | – | |
| | Upholstered seat pad | Price group | 2 | SE-PD-(5) | | | | | | | 308 |
| | | | 3 | | | | | | | | 340 |
| | | | 4 | | | | | | | | 376 |
| | | | 5 | | | | | | | | 400 |
| | | | 6 | | | | | | | | 620 |
| Armrests | No armrests | | | GD | | | | | | • | |
| | External | One armrest – available only with seat-replacing top on the edge of bench | | Powder-coated | ARM-EX-(3) | | | | | | 98 |
| | | Two armrests on both sides of bench – not available with seat-replacing top on the edge of bench | | Powder-coated | | | | | | | 195 |

(3) – Please specify metal colour code – [see finishes](#)

(4) – Please specify plastic colour code – [see finishes](#)

(5) – Please specify upholstery colour code from selected price group – [see finishes](#)

• Available as standard (included in basic price)

PRICE GROUP 2: Cura, Cura Loop, Valencia, Xtreme.
PRICE GROUP 3: Silvertex, Step/Step Melange,
PRICE GROUP 4: Blazer, Main Line Flax, Oceanic, skai Parotega, Synergy
PRICE GROUP 5: Remix 3
PRICE GROUP 6: Nappa leather

| | | | | | UNIVERSO BENCH 4U 4L P | | | |
|---|---|---|---------------------|------------------------|------------------------|-----|-----|-------|
| | No top | | | | | | • | |
| | Top position (7) | Top finish (1) | Frame finish (3) | Price group | | | | |
| Seat-replacing top* | A, B, C or D | Compact Laminate U0901TP Traceless Black | Powder-coated | 2 | TF-(7)-(1)/(3) | 133 | 64 | - 5 |
| | | | | 3 | | | 55 | - 20 |
| | | | | 4 | | | 47 | - 40 |
| | | | | 5 | | | 38 | - 52 |
| | | | | 6 | | | 20 | - 150 |
| | | | | | | | | |
| Glides | Plastic | | | GD | | | • | |
| | Plastic nonskid | | | GDN | | | 12 | |
| | Plastic with felt | | | GDF | | | 9 | |
| Foam | Flame retardant foam | | | FFR2 | | | • | • |
| | Flame retardant foam with fireproof fabric | | | FFRF | — | | 129 | 238 |
| Wood and wood-based materials | Raw material from certified forests, FSC certificate – authorized companies | | | | | | • | • |
| | | | | for version with a top | FSCMIX | | | • |
| Sample order UNIVERSO BENCH 4U 4L P (E-BK/BK CC-KO GD) | | | | | | | | |

*rectangular top instead of seat, 500 × 400 mm, thickness 13 mm

① – Please specify wood colour code – [see finishes](#)

③ – Please specify metal colour code – [see finishes](#)

⑦ – Please specify seat-replacing top position

• Available as standard (included in basic price)

PRICE GROUP 2: Cura, Cura Loop, Valencia, Xtreme,
PRICE GROUP 3: Silvertex, Step/Step Melange,
PRICE GROUP 4: Blazer, Main Line Flax, Oceanic, skai Parotega, Synergy
PRICE GROUP 5: Remix 3
PRICE GROUP 6: Nappa leather

Price list

uni_verso 5-seater bench, plastic shell.

Shell made of plastic.

Legs made of powder-coated or polished aluminium,
beam powder-coated, with or without armrests, plastic glides.



UNIVERSO BENCH 5U 4L P

W 2760 mm
D 540 mm
H 820 mm
SH 450 mm
SH DIN 425 mm
WT 35 kg

Basic price (EUR)

1895

| | | | | Basic price (EUR) | | | |
|---------------------|--------------------------|--|---------------|-------------------|---|-----|-----|
| Frame | Beam | Legs | | | | | |
| | Powder-coated | Powder-coated | E-(3)/(3) | • | | | |
| | | Aluminium polished | | 96 | | | |
| Shell | Plastic | | CC-(4) | • | | | |
| Backrest pad | No backrest pad | | | • | • | – | |
| | | | 2 | | | 360 | |
| | | | 3 | | | 385 | |
| | Upholstered backrest pad | Price group | 4 | BA-PD-(5) | – | – | 435 |
| | | | 5 | | | | 465 |
| | | | 6 | | | | 645 |
| Seat pad | No seat pad | | | • | – | – | |
| | | | 2 | | | 385 | |
| | | | 3 | | | 425 | |
| | Upholstered seat pad | Price group | 4 | SE-PD-(5) | – | | 470 |
| | | | 5 | | | | 500 |
| | | | 6 | | | | 775 |
| Armrests | No armrests | | GD | • | | | |
| | External | One armrest – available only with seat-replacing top on the edge of bench | Powder-coated | | | 98 | |
| | | Two armrests on both sides of bench – not available with seat-replacing top on the edge of bench | Powder-coated | ARM-EX-(3) | | | 195 |

(3) – Please specify metal colour code – see finishes

(4) – Please specify plastic colour code – see finishes

(5) – Please specify upholstery colour code from selected price group – see finishes

• Available as standard (included in basic price)

PRICE GROUP 2: Cura, Cura Loop, Valencia, Xtreme.

PRICE GROUP 3: Silvertex, Step/Step Melange.

PRICE GROUP 4: Blazer, Main Line Flax, Oceanic, skai Parotega, Synergy

PRICE GROUP 5: Remix 3

PRICE GROUP 6: Nappa leather

| | | | | | UNIVERSO BENCH 5U 4L P | | | |
|--------------------------------------|---|---|---------------------|------------------------|------------------------|-----|-----|-------|
| | No top | | | | | • | | |
| | Top position (7) | Top finish (1) | Frame finish (3) | Price group | | | | |
| Seat-replacing top* | A, B, C, D or E | Compact Laminate U0901TP Traceless Black | Powder-coated | 2 | TF-(7)-(1)/(3) | 133 | 64 | - 5 |
| | | | | 3 | | | 55 | - 20 |
| | | | | 4 | | | 47 | - 40 |
| | | | | 5 | | | 38 | - 52 |
| | | | | 6 | | | 20 | - 150 |
| | | | | | | | | |
| Glides | Plastic | | | | GD | • | | |
| | Plastic nonskid | | | | GDN | 12 | | |
| | Plastic with felt | | | | GDF | 9 | | |
| Foam | Flame retardant foam | | | | FFR2 | • | • | |
| | Flame retardant foam with fireproof fabric | | | | FFRF | 161 | 298 | |
| Wood and wood-based materials | Raw material from certified forests, FSC certificate – authorized companies | | | | FSC | • | • | |
| | | | | for version with a top | FSCMIX | • | | |
| Sample order | UNIVERSO BENCH 5U 4L P (E-BK/BK CC-KO GD) | | | | | | | |

*rectangular top instead of seat, 500 × 400 mm, thickness 13 mm

① – Please specify wood colour code – [see finishes](#)

③ – Please specify metal colour code – [see finishes](#)

⑦ – Please specify seat-replacing top position

• Available as standard (included in basic price)

PRICE GROUP 2: Cura, Cura Loop, Valencia, Xtreme,
PRICE GROUP 3: Silvertex, Step/Step Melange,
PRICE GROUP 4: Blazer, Main Line Flax, Oceanic, skai Parotega, Synergy
PRICE GROUP 5: Remix 3
PRICE GROUP 6: Nappa leather

Price list

uni_verso 6-seater bench, plastic shell.

Shell made of plastic.

Legs made of powder-coated or polished aluminium,
beam powder-coated, with or without armrests, plastic glides.



UNIVERSO BENCH 6U 4L P

W 2760 mm
D 540 mm
H 820 mm
SH 450 mm
SH DIN 425 mm
WT 35 kg

Basic price (EUR)

2157

| | Beam | Legs | | | | | | | |
|--------------------------|--------------------------|--|---------------|------------|--|--|-----|-----|-----|
| Frame | Powder-coated | Powder-coated | E-(3)/(3) | | | | • | | |
| | | Aluminium polished | | | | | 96 | | |
| Shell | Plastic | | CC-(4) | | | | • | | |
| Backrest pad | No backrest pad | | | | | | • | | |
| | Upholstered backrest pad | Price group | 2 | BA-PD-(5) | | | | — | |
| | | | 3 | | | | | 432 | |
| | | | 4 | | | | | 462 | |
| | | | 5 | | | | | 522 | |
| | | | 6 | | | | | 558 | |
| Upholstered backrest pad | | 6 | | | | | 774 | | |
| Seat pad | No seat pad | | | | | | • | | |
| | Upholstered seat pad | Price group | 2 | SE-PD-(5) | | | | — | |
| | | | 3 | | | | | 462 | 462 |
| | | | 4 | | | | | 510 | 510 |
| | | | 5 | | | | | 564 | 564 |
| | | | 6 | | | | | 600 | 600 |
| Upholstered seat pad | | 6 | | | | | 930 | | |
| Armrests | No armrests | | | GD | | | • | | |
| | External | One armrest – available only with seat-replacing top on the edge of bench | Powder-coated | ARM-EX-(3) | | | 98 | | |
| | | Two armrests on both sides of bench – not available with seat-replacing top on the edge of bench | Powder-coated | | | | 195 | | |

(3) – Please specify metal colour code – [see finishes](#)

(4) – Please specify plastic colour code – [see finishes](#)

(5) – Please specify upholstery colour code from selected price group – [see finishes](#)

• Available as standard (included in basic price)

PRICE GROUP 2: Cura, Cura Loop, Valencia, Xtreme.

PRICE GROUP 3: Silvertex, Step/Step Melange,

PRICE GROUP 4: Blazer, Main Line Flax, Oceanic, skai Parotega, Synergy

PRICE GROUP 5: Remix 3

PRICE GROUP 6: Nappa leather

| | | | | | UNIVERSO BENCH 6U 4L P | | | |
|--------------------------------------|---|--|---------------------|------------------------|------------------------|-----|-----|-------|
| | No top | | | | | • | | |
| | Top position (7) | Top finish (1) | Frame finish (3) | Price group | | | | |
| Seat-replacing top* | A, B, C, D, E or F | Compact Laminate U0901TP Traceless Black | Powder-coated | 2 | TF-(7)-(1)/(3) | 133 | 64 | - 5 |
| | | | | 3 | | | 55 | - 20 |
| | | | | 4 | | | 47 | - 40 |
| | | | | 5 | | | 38 | - 52 |
| | | | | 6 | | | 20 | - 150 |
| | | | | | | | | |
| Glides | Plastic | | | | GD | • | | |
| | Plastic nonskid | | | | GDN | 12 | | |
| | Plastic with felt | | | | GDF | 9 | | |
| Foam | Flame retardant foam | | | | FFR2 | • | • | |
| | Flame retardant foam with fireproof fabric | | | | FFRF | 193 | 357 | |
| Wood and wood-based materials | Raw material from certified forests, FSC certificate – authorized companies | | | | FSC | – | • | • |
| | | | | for version with a top | FSCMIX | | • | |
| Sample order | UNIVERSO BENCH 6U 4L P (E-BK/BK CC-KO GD) | | | | | | | |

*rectangular top instead of seat, 500 × 400 mm, thickness 13 mm

① – Please specify wood colour code – [see finishes](#)

③ – Please specify metal colour code – [see finishes](#)

⑦ – Please specify seat-replacing top position

• Available as standard (included in basic price)

PRICE GROUP 2: Cura, Cura Loop, Valencia, Xtreme,
PRICE GROUP 3: Silvertex, Step/Step Melange,
PRICE GROUP 4: Blazer, Main Line Flax, Oceanic, skai Parotega, Synergy
PRICE GROUP 5: Remix 3
PRICE GROUP 6: Nappa leather

Price list

Floor fixing (type 2)

Set of floor fixing elements for benches



BENCH ACCESSORY FF 2

Basic price (EUR)

63

uni_verso chair/hocker on 4 wooden legs, plastic shell

Shell made of plastic.
 Frame made of solid beech wood, plastic or metal glides.
 Footrest in hocker frame made of chromed steel.



| | | | | UNIVERSO FRAME CHAIR 4L LWM P | | | UNIVERSO FRAME CHAIR HKR 4L LWM P | | | | | |
|-------------------------------|---|---------------|---|---|---------|--|--|----|--|--|--|--|
| | | | | W 480 mm D 520 mm H 820 mm SH 450 mm SH DIN 43,50 mm WT 5,5 kg | | | W 480 mm D 560 mm H 1170 mm SH 800 mm SH DIN 78,50 mm WT 7 kg | | | | | |
| | | | | Basic price (EUR) | | | | | | | | |
| | | | | 397 | | | 605 | | | | | |
| Frame | Mounting | Legs | | | | | | | | | | |
| | Powder-coated | Natural beech | | E-③/① | | | | | | | | |
| | | Stained beech | – | E-AB-③/① | 19 | | | 19 | | | | |
| Footrest | Chrom | | | FB-③ | | | | | | | | |
| Shell | Plastic | | | CC-④ | | | | | | | | |
| Backrest pad | No backrest pad | | | | | | | | | | | |
| | Upholstered backrest pad | Price group | 2 | | | | | | | | | |
| | | | 3 | | | | | | | | | |
| | | | 4 | | BA-PD-⑤ | | | | | | | |
| | | | 5 | | | | | | | | | |
| | | | 6 | | | | | | | | | |
| No seat pad | | | | | | | | | | | | |
| Seat pad | Upholstered seat pad | Price group | 2 | | | | | | | | | |
| | | | 3 | | | | | | | | | |
| | | | 4 | | SE-PD-⑤ | | | | | | | |
| | | | 5 | | | | | | | | | |
| | | | 6 | | | | | | | | | |
| Armrests | None | | | | | | | | | | | |
| | Plastic armrests | | | | | | | | | | | |
| Glides | Plastic | | | | | | | | | | | |
| | Plastic with felt | | | | | | | | | | | |
| | Protect glides | | | | | | | | | | | |
| Foam | Flame retardant foam | | | | | | | | | | | |
| | Flame retardant foam with fireproof fabric | | | | | | | | | | | |
| Wood and wood-based materials | Raw material from certified forests, FSC certificate – authorized companies | | | FSC | | | | | | | | |
| Wooden elements lacquering | Water lacquer UV | | | | | | | | | | | |
| | Water lacquer | | | | | | | | | | | |

Sample order UNIVERSO FRAME CHAIR 4L LWM P (E-WS/SKNB CC-KO FSC UV)

- ① – Please specify wood colour code – [see finishes](#)
 ③ – Please specify metal colour code – [see finishes](#)
 ④ – Please specify plastic colour code – [see finishes](#)
 ⑤ – Please specify upholstery colour code from selected price group – [see finishes](#)
- Available as standard (included in basic price)

PRICE GROUP 2: Cura, Cura Loop, Valencia, Xtreme,
 PRICE GROUP 3: Silvertex, Step/Step Melange,
 PRICE GROUP 4: Blazer, Main Line Flax, Oceanic, skai Parotega, Synergy
 PRICE GROUP 5: Remix 3
 PRICE GROUP 6: Nappa leather

Price list

uni_verso chair on 4 metal legs, plywood shell

Shell made of beech plywood.
4 leg frame made of powder-coated or chromed steel,
with or without armrests, stackable, plastic or metal glides.



| | | | | UNIVERSO FRAME CHAIR 4L W | UNIVERSO FRAME CHAIR 4LA W | | | | | | | |
|-------------------------------|---|-------------|-------|---|---|------|----|-----|------|----|-----|-----|
| | | | | W 540 mm D 520 mm H 840 mm SH 450 mm SH DIN 425 mm WT 5,5 kg | W 610 mm D 520 mm H 840 mm SH 450 mm SH DIN 425 mm WT 6,5 kg | | | | | | | |
| | | | | Basic price (EUR) | | | | | | | | |
| | | | | 239 | 336 | | | | | | | |
| Seat height | 450 mm | | SH450 | • | | | | • | | | | |
| | 500 mm | | SH500 | 45 | | | | 45 | | | | |
| Frame | Powder-coated | | E-③ | • | | | | • | | | | |
| | Chrom | | | 20 | | | | 40 | | | | |
| | Satin chrome (for SH450) | | E-③ | 23 | | | | 48 | | | | |
| Shell | Natural beech | | | • | | | | • | | | | |
| | Stained beech | | CC-① | 20 | | | | 20 | | | | |
| Backrest pad | No backrest pad | | | • | • | — | • | • | — | | | |
| | Upholstered backrest pad | Price group | 2 | | | | 76 | | | 76 | | |
| | | | 3 | | | | 82 | | | 82 | | |
| | | | 4 | | BA-PD-⑤ | — | — | 92 | — | — | 92 | |
| | | | 5 | | | | | 98 | | | 98 | |
| | | | 6 | | | | | 137 | | | 137 | |
| Seat pad | No seat pad | | | • | — | — | • | — | — | | | |
| | Upholstered seat pad | Price group | 2 | | | | 82 | 82 | | 82 | 82 | |
| | | | 3 | | | | 90 | 90 | | 90 | 90 | |
| | | | 4 | | SE-PD-⑤ | — | — | 99 | 99 | — | 99 | 99 |
| | | | 5 | | | | | 106 | 106 | | 106 | 106 |
| | | | 6 | | | | | 164 | 164 | | 164 | 164 |
| Armpads | No armrest pads | | | — | — | — | | | • | | | |
| | Black plastic armpads | | AP-KB | | | | | | 40 | | | |
| Glides | Plastic | | GD | | | | | | • | | | |
| | Plastic with felt | | GDF | | | 8 | | | 8 | | | |
| | Protect glides | | GDT | | | 9 | | | 9 | | | |
| Foam | Flame retardant foam | | FFR2 | | | • | • | | • | • | | |
| | Flame retardant foam with fireproof fabric | | FFRF | — | | 33 | 60 | — | 33 | 60 | | |
| Wood and wood-based materials | Raw material from certified forests, FSC certificate – authorized companies | | FSC | | | • | | | • | | | |
| Wooden elements lacquering | Water lacquer UV | | UV | | | • | | | • | | | |
| | Water lacquer | | | | | – 20 | | | – 20 | | | |

Sample order UNIVERSO FRAME CHAIR 4L W (SH450 E-WS CC-SKNB FSC UV)

- ① – Please specify wood colour code – [see finishes](#)
- ③ – Please specify metal colour code – [see finishes](#)
- ⑤ – Please specify upholstery colour code from selected price group – [see finishes](#)
- Available as standard (included in basic price)

PRICE GROUP 2: Cura, Cura Loop, Valencia, Xtreme.
PRICE GROUP 3: Silvertex, Step/Step Melange,
PRICE GROUP 4: Blazer, Main Line Flax, Oceanic, skai Parotega, Synergy
PRICE GROUP 5: Remix 3
PRICE GROUP 6: Nappa leather

uni_verso chair on 4 metal legs, fully upholstered shell

Fully upholstered seat.
4 leg frame made of powder-coated or chromed steel, with or without armrests, plastic or metal glides.



| UNIVERSO FRAME CHAIR 4L UPH | UNIVERSO FRAME CHAIR 4LA UPH |
|---|---|
| W 540 mm D 520 mm H 840 mm SH 450 mm SH DIN 440 mm WT 6 kg | W 610 mm D 520 mm H 840 mm SH 450 mm SH DIN 440 mm WT 7 kg |

Basic price (EUR) according to upholstery price group

| | | | | |
|--------------------------------------|---|-------|-----|-----|
| | Price group 2 | | 411 | 511 |
| | Price group 3 | | 431 | 526 |
| | Price group 4 | | 450 | 550 |
| | Price group 5 | | 466 | 564 |
| | Price group 6 | | 657 | 756 |
| Seat height | 450 mm | SH450 | • | • |
| | 500 mm | SH500 | 45 | 45 |
| Frame | Powder-coated | E-③ | • | • |
| | Chrom | | 20 | 40 |
| | Satin chrome (for SH450) | E-③ | 23 | 48 |
| Shell | Fully upholstered | BS-⑤ | • | • |
| Armpads | No armrest pads | | | • |
| | Black plastic armpads | AP-KB | — | 40 |
| Glides | Plastic | GD | • | • |
| | Plastic with felt | GDF | 8 | 8 |
| | Protect glides | GDT | 9 | 9 |
| Foam | Flame retardant foam | FFR2 | • | • |
| | Flame retardant foam with fireproof fabric | FFRF | 68 | 68 |
| Wood and wood-based materials | Raw material from certified forests, FSC certificate – authorized companies | FSC | • | • |
| Sample order | UNIVERSO FRAME CHAIR 4L UPH (SH450 E-WS BS-CPC10 FFR2 FSC) | | | |

③ – Please specify metal colour code – [see finishes](#)

⑤ – Please specify upholstery colour code from selected price group – [see finishes](#)

- Available as standard (included in basic price)

PRICE GROUP 2: Cura, Cura Loop, Valencia, Xtreme,
PRICE GROUP 3: Silvertex, Step/Step Melange,
PRICE GROUP 4: Blazer, Main Line Flax, Oceanic, skai Parotega, Synergy
PRICE GROUP 5: Remix 3
PRICE GROUP 6: Nappa leather

Price list

uni_verso chair on 4 metal legs, fully upholstered shell with high backrest

Fully upholstered seat and high backrest.
4 leg frame made of powder-coated or chromed steel, with or without armrests, plastic glides.



| | | | UNIVERSO FRAME CHAIR 4L HB UPH | UNIVERSO FRAME CHAIR 4LA HB UPH |
|--------------------------------------|---|-------|---|---|
| | | | W 540 mm D 610 mm H 970 mm SH 450 mm SH DIN 440 mm WT 6,5 kg | W 610 mm D 610 mm H 970 mm SH 450 mm SH DIN 440 mm WT 7,5 kg |
| | | | Basic price (EUR) according to upholstery price group | |
| | Price group 2 | | 456 | 555 |
| | Price group 3 | | 476 | 575 |
| | Price group 4 | | 508 | 607 |
| | Price group 5 | | 529 | 627 |
| | Price group 6 | | 734 | 834 |
| Seat height | 450 mm | SH450 | • | • |
| | 500 mm | SH500 | 45 | 45 |
| Frame | Powder-coated | E-③ | • | • |
| | Chrom | E-③ | 20 | 40 |
| Shell | Fully upholstered | BS-⑤ | • | • |
| Armpads | No armrest pads | | — | • |
| | Black plastic armpads | AP-KB | | 40 |
| Glides | Plastic | GD | • | • |
| | Plastic with felt | GDF | 8 | 8 |
| | Protect glides | GDT | 9 | 9 |
| Foam | Flame retardant foam | FFR2 | • | • |
| | Flame retardant foam with fireproof fabric | FFRF | 100 | 100 |
| Wood and wood-based materials | Raw material from certified forests, FSC certificate – authorized companies | FSC | • | • |
| Sample order | UNIVERSO FRAME CHAIR 4L HB UPH (SH450 E-WS BS-CPC10 FFR2 FSC) | | | |

③ – Please specify metal colour code – [see finishes](#)

⑤ – Please specify upholstery colour code from selected price group – [see finishes](#)

• Available as standard (included in basic price)

PRICE GROUP 2: Cura, Cura Loop, Valencia, Xtreme.
PRICE GROUP 3: Silvertex, Step/Step Melange,
PRICE GROUP 4: Blazer, Main Line Flax, Oceanic, skai Parotega, Synergy
PRICE GROUP 5: Remix 3
PRICE GROUP 6: Nappa leather

uni_verso chair on sled metal frame

Shell made of plastic or beech plywood.
Sled frame made of powder-coated or chromed steel, plastic glides.



| UNIVERSO FRAME CHAIR CFS P | UNIVERSO FRAME CHAIR CFS W |
|---|---|
| W 540 mm D 540 mm H 820 mm SH 450 mm SH DIN 425 mm WT 6,5 kg | W 540 mm D 540 mm H 840 mm SH 450 mm SH DIN 430 mm WT 6,5 kg |

Basic price (EUR)

| | | | | 289 | | | 301 | | | |
|--------------------------------------|---|-------------|------|---------|----|----|-----|------|----|-----|
| Frame | Powder-coated | | E-③ | • | | | | • | | |
| | Chrom | | | 38 | | | | 38 | | |
| | Satin chrome | | E-③ | 48 | | | | 48 | | |
| Shell | Plastic | | CC-④ | • | | | | — | | |
| | Natural beech | | | — | | | | • | | |
| | Stained beech | | CC-① | — | | | | 20 | | |
| Backrest pad | No backrest pad | | | • | • | — | • | • | — | |
| | Upholstered backrest pad | Price group | 2 | BA-PD-⑤ | — | — | 72 | — | — | 72 |
| | | | 3 | | | | 77 | | | 77 |
| | | | 4 | | | | 87 | | | 87 |
| | | | 5 | | | | 93 | | | 93 |
| | | | 6 | | | | 129 | | | 129 |
| No seat pad | | | • | — | — | • | — | — | | |
| Seat pad | Upholstered seat pad | Price group | 2 | SE-PD-⑤ | — | — | 77 | — | — | 77 |
| | | | 3 | | | | 85 | | | 85 |
| | | | 4 | | | | 94 | | | 94 |
| | | | 5 | | | | 100 | | | 100 |
| | | | 6 | | | | 155 | | | 155 |
| | No possibility of integration | | | • | | | | • | | |
| Linking element for glides | | IN-GD | | 13 | | | | 13 | | |
| Glides | Plastic | | GD | • | | | | • | | |
| | Plastic with felt | | GDF | | 8 | | | 8 | | |
| Foam | Flame retardant foam | | FFR2 | — | • | • | — | • | • | |
| | Flame retardant foam with fireproof fabric | | FFRF | | 33 | 60 | | 33 | 60 | |
| Wood and wood-based materials | Raw material from certified forests, FSC certificate – authorized companies | | FSC | — | • | • | | • | | |
| Wooden elements lacquering | Water lacquer UV | | UV | | — | | | • | | |
| | | | | | — | | | – 20 | | |

Sample order UNIVERSO FRAME CHAIR CFS P (E-BK CC-KO GD ASM-F)

- ① – Please specify wood colour code – [see finishes](#)
- ③ – Please specify metal colour code – [see finishes](#)
- ④ – Please specify plastic colour code – [see finishes](#)
- ⑤ – Please specify upholstery colour code from selected price group – [see finishes](#)

• Available as standard (included in basic price)

PRICE GROUP 2: Cura, Cura Loop, Valencia, Xtreme,
PRICE GROUP 3: Silvertex, Step/Step Melange,
PRICE GROUP 4: Blazer, Main Line Flax, Oceanic, skai Parotega, Synergy
PRICE GROUP 5: Remix 3
PRICE GROUP 6: Nappa leather

Price list

uni_verso chair on sled metal frame, fully upholstered shell

Fully upholstered seat.
Sled frame made of powder-coated or chromed steel, plastic glides.



UNIVERSO FRAME CHAIR CFS UPH

W 540 mm
D 540 mm
H 840 mm
SH 450 mm
SH DIN 44,50 mm
WT 7 kg

| | | | Basic price (EUR) according to upholstery price group |
|--------------------------------------|---|--------|---|
| | Price group 2 | | 446 |
| | Price group 3 | | 463 |
| | Price group 4 | | 483 |
| | Price group 5 | | 497 |
| | Price group 6 | | 677 |
| Frame | Powder-coated | E-(3) | • |
| | Chrom | | 38 |
| | Satin chrome | E-(3) | 48 |
| Shell | Fully upholstered | BS-(5) | • |
| Row integration | No possibility of integration | | • |
| | Linking element for glides | IN-GD | 13 |
| Glides | Plastic | GD | • |
| | Plastic with felt | GDF | 8 |
| Foam | Flame retardant foam | FFR2 | • |
| | Flame retardant foam with fireproof fabric | FFRF | 68 |
| Wood and wood-based materials | Raw material from certified forests, FSC certificate – authorized companies | FSC | • |
| Sample order | UNIVERSO FRAME CHAIR CFS UPH (E-WS BS-CPC11 GD FFR2 FSC) | | |

(3) – Please specify metal colour code – [see finishes](#)

(5) – Please specify upholstery colour code from selected price group – [see finishes](#)

• Available as standard (included in basic price)

PRICE GROUP 2: Cura, Cura Loop, Valencia, Xtreme.
PRICE GROUP 3: Silvertex, Step/Step Melange,
PRICE GROUP 4: Blazer, Main Line Flax, Oceanic, skai Parotega, Synergy
PRICE GROUP 5: Remix 3
PRICE GROUP 6: Nappa leather

uni_verso hocker chair on 4 metal/wooden legs, upholstered shell

Fully upholstered seat and low backrest.
Hocker frame made of powder-coated or chromed steel or solid beech wood with chromed steel footrest.
Plastic glides.



| UNIVERSO FRAME CHAIR HKR 4L LB UPH | UNIVERSO FRAME CHAIR HKR 4L LB LWM UPH |
|--|--|
| W 480 mm D 520 mm H 1000 mm SH 800 mm SH DIN 790 mm WT 7,5 kg | W 480 mm D 520 mm H 1000 mm SH 800 mm SH DIN 810 mm WT 7 kg |

| | | | Basic price (EUR) according to upholstery price group | | |
|-----------------------------------|---|---|---|------|----|
| | Price group 2 | | 649 | 720 | |
| | Price group 3 | | 655 | 727 | |
| | Price group 4 | | 667 | 735 | |
| | Price group 5 | | 673 | 744 | |
| | Price group 6 | | 885 | 949 | |
| Frame | Chrom | E-③ | • | — | |
| | Mounting | Legs | | | |
| | Powder-coated | Natural beech | E-③/① | — | • |
| | | Stained beech | | — | 19 |
| Footrest | Chrome | FB-③ | — | • | |
| Shell | Fully upholstered | BS-⑤ | • | • | |
| | Plastic | GD | • | • | |
| Glides | Plastic with felt | GDF | 8 | 8 | |
| | Protect glides | GDT | — | 9 | |
| | Flame retardant foam | FFR2 | • | • | |
| Foam | Flame retardant foam with fireproof fabric | FFRF | 56 | — | |
| | Wood and wood-based materials | Raw material from certified forests, FSC certificate – authorized companies | FSC | • | • |
| Wooden elements lacquering | Water lacquer UV | UV | — | • | |
| | | | — | - 20 | |
| Sample order | UNIVERSO FRAME CHAIR HKR 4L LB UPH (E-CR BS-CPC10 GDF FFR2 FSC) | | | | |

- ① – Please specify wood colour code – [see finishes](#)
- ③ – Please specify metal colour code – [see finishes](#)
- ⑤ – Please specify upholstery colour code from selected price group – [see finishes](#)
- Available as standard (included in basic price)

PRICE GROUP 2: Cura, Cura Loop, Valencia, Xtreme,
PRICE GROUP 3: Silvertex, Step/Step Melange,
PRICE GROUP 4: Blazer, Main Line Flax, Oceanic, skai Parotega, Synergy
PRICE GROUP 5: Remix 3
PRICE GROUP 6: Nappa leather

Price list

uni_verso swivel chair

Fully upholstered seat.
Swivel base made of powder-coated or polished aluminium,
armrests, plastic glides.



UNIVERSO SWIVEL CHAIR HB UPH

W 690 mm
D 690 mm
H 970 mm
SH 450 mm
SH DIN 450 mm
WT 11,5 kg

Basic price (EUR) according to upholstery price group

| | | | |
|--------------------------------------|---|-------------------|------|
| | Price group 2 | | 970 |
| | Price group 3 | | 990 |
| | Price group 4 | | 1021 |
| | Price group 5 | | 1040 |
| | Price group 6 | | 1245 |
| Column | Powder-coated | CO- ^③ | • |
| | Chrom | | 20 |
| Shell | Fully upholstered | BS- ^⑤ | • |
| Armrests | Powder-coated | ARF- ^③ | • |
| | Chrom | | 38 |
| Base | Powder-coated | BC- ^③ | • |
| | Aluminium polished | | 23 |
| Glides | Plastic | GD | • |
| | Plastic nonskid | GDN | 6 |
| | Plastic with felt | GDF | 8 |
| Foam | Flame retardant foam | FFR2 | • |
| | Flame retardant foam with fireproof fabric | FFRF | 100 |
| Wood and wood-based materials | Raw material from certified forests, FSC certificate – authorized companies | FSC | • |
| Sample order | UNIVERSO SWIVEL CHAIR HB UPH (CO-CR BS-CPC10ARF-WS BC-POL GD FFR2 FSC) | | |

^③ – Please specify metal colour code – [see finishes](#)

^⑤ – Please specify upholstery colour code from selected price group – [see finishes](#)

- Available as standard (included in basic price)

PRICE GROUP 2: Cura, Cura Loop, Valencia, Xtreme.
PRICE GROUP 3: Silvertex, Step/Step Melange,
PRICE GROUP 4: Blazer, Main Line Flax, Oceanic, skai Parotega, Synergy
PRICE GROUP 5: Remix 3
PRICE GROUP 6: Nappa leather

Finishes

Wood

Natural



SKNB
Natural
Beech

Stained



2.07Y
Black



2.06S
Slate



S39
Light Grey



2.09S
White



2.0CB
Acacia



SK40
Oak



2.0CC
Walnut

Compact Laminate

for tables in benches and writing tablets



U0901TP
Traceless
Black

Metal



NCS S 2005-Y60R
Cashmere
NK



RAL 1024
Ochre Yellow
OY



RAL 030 50 40
Vermilion
Red
VR



RAL 6003
Olive Green
OG



RAL 5000
Violet Blue
VB



Chrome
CR



**Satin
Chrome**
SCR



**Polished
Aluminium**
POL



RAL 9003
Signal White
WS



Silk
KSK



RAL 9006
White
Aluminium
WK



Silver 98
SV



DB 703
Iron Mica
IM



RAL 9005
Jet Black
BK

Plastic

for armpads



KO
Stone



KKF
Flax Silk

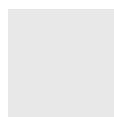

KI
Arctic



KB
Black

General notes

All specified dimensions are approximate. Subject to minor modifications or differences for reasons of design improvements or for technical reasons.

- W = width
- D = depth
- H = height
- DI = diameter
- SH = seat height
- SH DIN = seat height measured acc. to DIN EN 1335-1

In compliance with the highest quality standards "Quality is irreplaceable." Guided by this principle, each product line is subjected to stringent quality testing.

Only the products marked in this document are FSC® (FSC®-C120977) certified. Look for our FSC®-certified products. Sale of products that meet the FSC® requirements is possible only by Nowy Styl Sp. z o.o., Nowy Styl Nederland B.V. and Kusch + Co GmbH.



The mark of responsible forestry

The FSC® certificate applies to responsible forest management and the entire flow of raw materials from the forest to the customer. Each stage of the chain is monitored in terms of social, ecological and economic performance. The product with the FSC® label gives customers a guarantee that the wood used for the production of the product comes from sources managed in a sustainable manner.

Warranty

Manufacturer declares that the products shall be free from defects in material or workmanship. The warranty is given to the original purchaser only, for normal commercial usage. Detailed terms of warranty and warranty periods are available at <https://www.kusch.com/en/warranty>.

¡hola! price list 2026

¡hola!

Design by Jorge Pensi

Chair/bar hocker on 4 metal legs



HOLA FRAME
CHAIR 4L P

HOLA FRAME
CHAIR 4L OD P

HOLA FRAME
CHAIR HKR 4L P

Bench



HOLA BENCH 2U 4L P

HOLA BENCH 3U 4L P

Chairon 4 metal legs, hygienic version



HOLA FRAME
CHAIR 4L HYG P

kuschmed[®]
HYGIENIC-LINE

Bench hygienic version



HOLA BENCH 2U
4L HYG P

HOLA BENCH 3U 4L
HYG P

kuschmed[®]
HYGIENIC-LINE

Price list

¡hola! chair on 4 metal legs

Seat, backrest and armrests made of plastic.
 Frame: 4 legs made of powder-coated or chromium plated steel,
 with or without armrests, stackable, plastic glides.
 Stacking plate underneath the seat for models with upholstery seat.



HOLA FRAME CHAIR 4L P

W 480 mm
 D 530 mm
 H 820 mm
 SH 450 mm
 SH DIN 420 mm
 WT 5 kg

Basic price (EUR)

183

| | | | | | | | | | | |
|--------------------|--|-------------|-----------------|-----------|--|--|---|----|----|----|
| Seat height | 450 mm | | SH450 | | | | • | | | |
| | 500 mm | | SH500 | | | | | | 45 | |
| Frame | Steel | | powder-coated | | | | | | • | |
| | | | chromium plated | E-③ | | | | | 19 | |
| | | | satin chrome | | | | | | 23 | |
| Backrest | Plastic backrest | | BA-④ | | | | • | • | – | |
| | | | | | | | | | 60 | |
| | Plastic backrest with upholstered backrest pad | Price group | 2 | | | | | | | 66 |
| | | | 3 | BA-PD-④/⑤ | | | | – | – | 75 |
| | | | 4 | | | | | | | 80 |
| | | 5 | | | | | | | | |
| Seat | Plastic seat | | SE-④ | | | | • | – | – | |
| | | | | | | | | | 67 | |
| | Plastic seat with upholstered seat pad | Price group | 2 | | | | | | | 67 |
| | | | 3 | SE-PD-④/⑤ | | | | – | | 76 |
| | | | 4 | | | | | | | 83 |
| | | 5 | | | | | | 90 | | |
| Armrests | None | | | | | | | | • | |
| | Plastic armrests (in backrest or seat colour) | | ARM-④ | | | | | | 63 | |

③ – Please specify metal colour code – [see finishes](#)

④ – Please specify plastic colour code – [see finishes](#)

⑤ – Please specify upholstery colour code from selected price group – [see finishes](#)

• Available as standard (included in basic price)

Price list

| | | HOLA FRAME CHAIR 4L P | | | |
|---------------------|---|-----------------------|----|----|----|
| Linking element | None | | • | | |
| | Clip linking (Not available for pads upholstered in fabrics: Valencia, Silvertex, skai Parotega) | IN-CL | 52 | | |
| Glides | Plastic | GD | • | | |
| | Plastic with felt | GDF | 8 | | |
| | Protect glides | GDT | 15 | | |
| Foam | Standard foam | FSTD | — | • | • |
| | Flame retardant foam | FFR2 | | 7 | 10 |
| | Flame retardant foam with fireproof fabric | FFRF | | 35 | 68 |
| Assembly | Assembled | ASM-F | • | | |
| Sample order | HOLA FRAME CHAIR 4L P (SH450 E-BL BA-KW SE-KW GD ASM-F) | | | | |

- Available as standard (included in basic price)

¡hola! chair on 4 metal legs, outdoor version

Seat, backrest and armrests made of plastic.
 Frame: 4 legs made of powder-coated steel, secured additionally with the primer,
 with or without armrests, stackable, plastic glides.



HOLA FRAME CHAIR 4L OD P

W 480 mm
 D 530 mm
 H 820 mm
 SH 450 mm
 SH DIN 420 mm
 WT 5 kg

Basic price (EUR)

227

| | | | |
|-----------------|------------------|---------|----|
| Frame | Powder-coated | E-(3) | • |
| Backrest | Plastic backrest | BA-(4) | • |
| Seat | Plastic seat | SE-(4) | • |
| Armrests | None | | • |
| | Plastic armrests | ARM-(4) | 63 |
| Glides | Plastic | GD | • |
| Assembly | Assembled | ASM-F | • |

Sample order HOLA FRAME CHAIR 4L OD P (WT BA-KK SE-KK GD ASM-F)

(3) – Please specify metal colour code – [see finishes](#)

(4) – Please specify plastic colour code – [see finishes](#)

- Available as standard (included in basic price)

Price list

¡hola! bar hocker on 4 metal legs

Seat and backrest made of plastic.
 Frame: 4 legs frame made of powder-coated or chromium plated steel, stackable, plastic glides.
 Stacking plate underneath the seat for models with upholstery on seats.



HOLA FRAME CHAIR HKR 4L P

W 490 mm
 D 540 mm
 H 1180 mm
 SH 800 mm
 SH DIN 780 mm
 WT 7,5 kg

| | | | | Basic price (EUR) | | | |
|-----------------|--|-----------------|------------------|---------------------------------|----|----|----|
| | | | | 424 | | | |
| Frame | Steel | powder-coated | E- ^③ | • | | | |
| | | chromium plated | | 19 | | | |
| | | satin chrome | | 23 | | | |
| Backrest | Plastic backrest with upholstered backrest pad | Price group | Plastic backrest | BA- ^④ / ^⑤ | • | • | – |
| | | | 2 | | – | – | 60 |
| | | | 3 | | – | – | 66 |
| | | | 4 | | – | – | 75 |
| | | | 5 | | – | – | 80 |
| Seat | Plastic seat with upholstered seat pad | Price group | Plastic seat | SE- ^④ / ^⑤ | • | – | – |
| | | | 2 | | – | 67 | 67 |
| | | | 3 | | – | 76 | 76 |
| | | | 4 | | – | 83 | 83 |
| | | | 5 | | – | 90 | 90 |
| Glides | Plastic | | GD | • | | | |
| | Plastic with felt | | GDF | 8 | | | |
| | Protect glides | | GDT | 15 | | | |
| Foam | Standard foam | | FSTD | – | • | • | |
| | Flame retardant foam | | FFR2 | – | 7 | 10 | |
| | Flame retardant foam with fireproof fabric | | FFRF | – | 35 | 68 | |
| Assembly | Assembled | | ASM-F | • | | | |

Sample order HOLA FRAME CHAIR HKR 4L P (E-BL BA-KT SE-KK GD ASM-F)

③ – Please specify metal colour code – [see finishes](#)

④ – Please specify plastic colour code – [see finishes](#)

⑤ – Please specify upholstery colour code from selected price group – [see finishes](#)

• Available as standard (included in basic price)

¡hola! bench

Seat, backrest and armrests made of plastic.
 Legs made of powder-coated or chromium plated steel, powder-coated steel beam, plastic glides.



HOLA BENCH 2U 4L P

W 1070 mm
 D 550 mm
 H 810 mm
 SH 450 mm
 SH DIN 420 mm

Basic price (EUR)

663

| | Beam | Legs | | | | | | | |
|-----------------|--|--|-----------------|---|---|---|----|-----|-----|
| Frame | | | powder-coated | | | • | | | |
| | Powder-coated steel | Steel | chromium plated | E-(3)/(3) | | | 29 | | |
| | | | satin chrome | | | | | 37 | |
| Backrest | Plastic backrest | | | BA-(4) | | • | • | • | |
| | Plastic backrest with upholstered backrest pad | Price group | 2 | BA-PD-(4)/(5) | - | - | - | 119 | |
| | | | 3 | | | | | 131 | |
| | | | 4 | | | | | 150 | |
| | | | 5 | | | | | 159 | |
| Plastic seat | | | SE-(4) | | • | - | - | | |
| Seat | Plastic seat with upholstered seat pad | Price group | 2 | SE-PD-(4)/(5) | - | - | - | 142 | 142 |
| | | | 3 | | | | | 159 | 159 |
| | | | 4 | | | | | 176 | 176 |
| | | | 5 | | | | | 189 | 189 |
| | None | | | | | | • | | |
| Armrests | External | Two armrests on both sides of bench – not available with seat-replacing top on the edge of bench | Plastic | ARM-EX-(4) | | | | 67 | |
| | | | | One armrest – available only with seat-replacing top on the edge of bench | | | | | 34 |

(3) – Please specify metal colour code – [see finishes](#)

(4) – Please specify plastic colour code – [see finishes](#)

(5) – Please specify upholstery colour code from selected price group – [see finishes](#)

• Available as standard (included in basic price)

Price list

| | | | | HOLA BENCH 2U 4L P | | |
|---|------------------|--|--|--------------------|----|-----|
| | None | | | | • | |
| | Top position (⑦) | Top finish (①) | Price group | | | |
| Seat-replacing top* | | | 2 | 84 | 22 | -36 |
| | A or B | Compact Laminate U0901TP Traceless Black | 3 | | 22 | -36 |
| | | | 4 | | 13 | -51 |
| | | | 5 | | 5 | -69 |
| | | | TF-⑦-① | | | |
| Wall spacer | None | | | • | | |
| | Wall spacer | | IN-WS | 117 | | |
| Glides | Glides | Plastic | GD | • | | |
| Foam | | | Standard foam | FSTD | • | • |
| | | | Flame retardant foam | FFR2 | 14 | 19 |
| | | | Flame retardant foam with fireproof fabric | FFRF | 72 | 136 |
| Assembly | Assembled | | ASM-F | • | | |
| Sample order HOLA BENCH 2U 4L P (E-WS/CR BA-KW SE-KW GD ASM-F) | | | | | | |

*rectangular top instead of seat, 450 × 400 mm, thickness 13 mm

① – Please specify table top colour code – [see finishes](#)

⑦ – Please specify seat-replacing top position

- Available as standard (included in basic price)

¡hola! bench

Seat, backrest and armrests made of plastic.
Legs made of powder-coated or chromium plated steel, powder-coated steel beam, plastic glides.

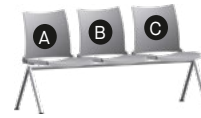

HOLA BENCH 3U 4L P

W 1590 mm
D 550 mm
H 810 mm
SH 450 mm
SH DIN 420 mm

Basic price (EUR)

940

| | Beam | Legs | | | | | | | |
|-----------------|--|--|---|---------------|--|--|--|-----|-----|
| Frame | Powder-coated steel | Steel | powder-coated | E-(3)/(3) | | | | • | |
| | | | chromium plated | | | | | 29 | |
| | | | satin chrome | | | | | 37 | |
| Backrest | Plastic backrest with upholstered backrest pad | Price group | Plastic backrest | BA-PD-(4)/(5) | | | | • | |
| | | | 2 | | | | | 179 | |
| | | | 3 | | | | | 196 | |
| | | | 4 | | | | | 224 | |
| | | | 5 | | | | | 238 | |
| Seat | Plastic seat with upholstered seat pad | Price group | Plastic seat | SE-PD-(4)/(5) | | | | • | |
| | | | 2 | | | | | 213 | 213 |
| | | | 3 | | | | | 238 | 238 |
| | | | 4 | | | | | 264 | 264 |
| | | | 5 | | | | | 284 | 284 |
| Armrests | External | Two armrests on both sides of bench – not available with seat-replacing top on the edge of bench | Plastic | ARM-EX-(4) | | | | • | |
| | | | One armrest – available only with seat-replacing top on the edge of bench | | | | | 67 | |
| | | | | | | | | 34 | |

③ – Please specify metal colour code – [see finishes](#)

④ – Please specify plastic colour code – [see finishes](#)

⑤ – Please specify upholstery colour code from selected price group – [see finishes](#)

• Available as standard (included in basic price)

Price list

| | | | | HOLA BENCH 3U 4L P | | |
|---|------------------|--|--|--------------------|-----|-----|
| | None | | | | • | |
| | Top position (⑦) | Top finish (①) | Price group | | | |
| Seat-replacing top* | | | 2 | 84 | 22 | -36 |
| | A, B or C | Compact Laminate U0901TP Traceless Black | 3 | | 22 | -36 |
| | | | 4 | | 13 | -51 |
| | | | 5 | | 5 | -69 |
| | | | | | | |
| | | | TF-⑦-① | | | |
| Wall spacer | None | | | | • | |
| | Wall spacer | | IN-WS | | 117 | |
| Glides | Glides | Plastic | GD | | • | |
| Foam | | | Standard foam | FSTD | • | • |
| | | | Flame retardant foam | FFR2 | 20 | 29 |
| | | | Flame retardant foam with fireproof fabric | FFRF | 108 | 204 |
| Assembly | Assembled | | ASM-F | | • | |
| Sample order HOLA BENCH 3U 4L P (E-WS/CR BA-KW SE-KW GD ASM-F) | | | | | | |

*rectangular top instead of seat, 450 × 400 mm, thickness 13 mm

① – Please specify table top colour code – [see finishes](#)

⑦ – Please specify seat-replacing top position

- Available as standard (included in basic price)

¡hola! chair on 4 metal legs, hygienic version

Seat, backrest and armrests made of plastic.
 Frame: 4 legs made of chromium plated, plastic glides.
 Seat underside closed with plastic cover. With or without armrests.
 Dirt-repellent, pore-free plastic surfaces.
 All surfaces easily accessible for cleaning or disinfection.



HOLA FRAME CHAIR 4L HYG P

W 480 mm
 D 530 mm
 H 820 mm
 SH 450 mm
 SH DIN 420 mm
 WT 5 kg

Basic price (EUR)

228

| | | | |
|--------------------|-----------------------|-------|----|
| Seat height | 450 mm | SH450 | • |
| | 500 mm | SH500 | 45 |
| Frame | Steel chromium plated | E-③ | • |
| Backrest | Plastic backrest | BA-④ | • |
| Seat | Plastic seat | SE-④ | • |
| Armrests | None | | • |
| | Plastic armrests | ARM-④ | 76 |
| | Protect glides | GDT | 15 |
| Assembly | Assembled | ASM-F | • |

Sample order HOLA FRAME CHAIR 4L HYG P (SH450 E-WS BA-KW SE-KW GDT ASM-F)

③ – Please specify metal colour code – [see finishes](#)

④ – Please specify plastic colour code – [see finishes](#)

- Available as standard (included in basic price)

¡hola! bench, hygienic version

Seat, backrest and armrests made of plastic.
Legs made of chromium plated, beam powder-coated, plastic glides.
Seat underside closed with plastic cover. With or without armrests.
Dirt-repellent, pore-free plastic surfaces.
All surfaces easily accessible for cleaning or disinfection.



**HOLA BENCH 2U 4L
HYG P**

W 1070 mm
D 550 mm
H 810 mm
SH 450 mm
SH DIN 420 mm

**HOLA BENCH 3U 4L
HYG P**

W 1590 mm
D 550 mm
H 810 mm
SH 450 mm
SH DIN 420 mm

Basic price (EUR)

760

1071

| | Beam | Legs | | | | |
|--------------------|---------------------|---------|-----------------|----------|-----|-----|
| Frame | Powder-coated steel | Steel | chromium plated | E-③/③ | • | • |
| | | | powder-coated | | 30 | 30 |
| Backrest | Plastic backrest | | | BA-④ | • | • |
| Seat | Plastic seat | | | SE-④ | • | • |
| Armrests | None | | | | • | • |
| | External | Plastic | | ARM-EX-④ | 76 | 76 |
| Wall spacer | None | | | | • | • |
| | Wall spacer | | | IN-WS | 117 | 117 |
| Glides | Plastic | | | GD | • | • |
| Assembly | Assembled | | | ASM-F | • | • |

Sample order HOLA BENCH 2U 4L HYG P (SH450 E-WS/CR BA-KW SE-KW GD ASM-F)

③ – Please specify metal colour code – [see finishes](#)

④ – Please specify plastic colour code – [see finishes](#)

• Available as standard (included in basic price)

¡hola! Floor fixing

Set of floor fixing elements for banches



BENCH ACCESSORY FF 1

Basic price (EUR)

63

Sample order BENCH ACCESSORY FF1

Finishes

Metal



Metal

for outdoor chairs

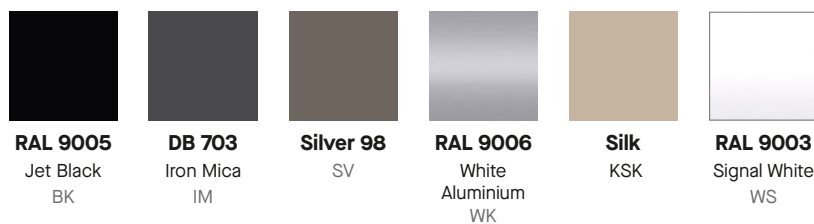

Metal

for bar hockers

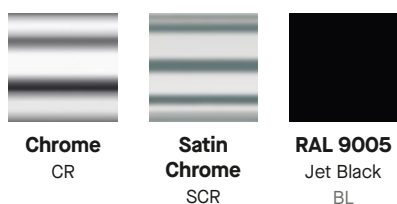

Metal

for benches

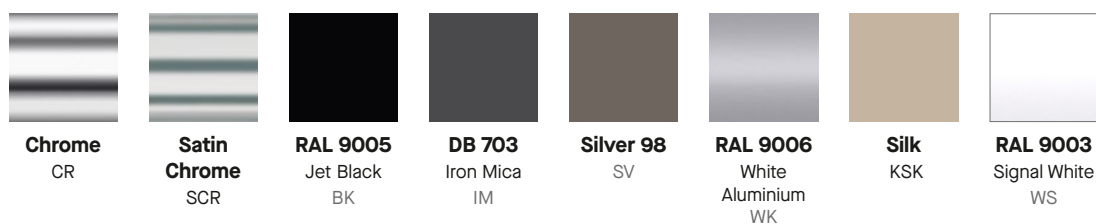

Laminate



U0901TP
Traceless
Black

Plastic



KB
Black



KG
Black Grey



KY
Light Grey



KQ
Quartz Grey



KK
Silk



KA
Salem



KE
Pimento



KC
Scampolo



KT
Tinkerbell



KL
Midnight
Blue

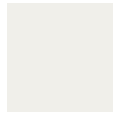

KW
Signal White

General notes

All specified dimensions are approximate. Subject to minor modifications or differences for reasons of design improvements or for technical reasons.

- W = width
- D = depth
- H = height
- DI = diameter
- SH = seat height
- SH DIN = seat height measured acc. to DIN EN 1335-1

In compliance with the highest quality standards "Quality is irreplaceable." Guided by this principle, each product line is subjected to stringent quality testing.

Warranty

Manufacturer declares that the products shall be free from defects in material or workmanship. The warranty is given to the original purchaser only, for normal commercial usage. Detailed terms of warranty and warranty periods are available at <https://www.kusch.com/en/warranty>

embla price list 2026

Embla

Design by Antonio Scaffidi

Upholstered chair on 4 wooden legs



EMBLA FRAME
CHAIR 4L
UPH

EMBLA FRAME
CHAIR 4LA
UPH

EMBLA FRAME
CHAIR 4L HB
UPH

EMBLA FRAME
CHAIR 4LA HB
UPH

Wooden chair on 4 legs



EMBLA FRAME
CHAIR 4L W

EMBLA FRAME
CHAIR 4LA W

Price list

Embla upholstered chair on 4 wooden legs

Upholstered seat and backrest.
Frame made of solid beech wood,
with or without armrests, stackable,
plastic glides.



| EMBLA FRAME CHAIR 4L UPH | EMBLA FRAME CHAIR 4LA UPH | EMBLA FRAME CHAIR 4L HB UPH | EMBLA FRAME CHAIR 4LA HB UPH |
|---|---|---|---|
| W 520 mm D 545 mm H 790 mm SH 460 mm SH DIN 425 mm WT 6,4 kg | W 600 mm D 545 mm H 790 mm SH 460 mm SH DIN 425 mm WT 7,0 kg | W 520 mm D 575 mm H 855 mm SH 460 mm SH DIN 425 mm WT 6,7 kg | W 600 mm D 575 mm H 855 mm SH 460 mm SH DIN 425 mm WT 7,3 kg |

Basic price (EUR)
according to upholstery price group

| | EMBLA FRAME CHAIR 4L UPH | EMBLA FRAME CHAIR 4LA UPH | EMBLA FRAME CHAIR 4L HB UPH | EMBLA FRAME CHAIR 4LA HB UPH |
|---------------|--------------------------|---------------------------|-----------------------------|------------------------------|
| Price group 2 | 328 | 405 | 360 | 445 |
| Price group 3 | 341 | 416 | 372 | 456 |
| Price group 4 | 355 | 432 | 388 | 473 |
| Price group 5 | 363 | 439 | 397 | 481 |
| Price group 6 | 433 | 511 | 472 | 555 |

| | | | | | | | |
|-------------------------------|---|---------|--------|------|------|------|----|
| Seat height | 460 mm | SH460 | • | • | • | • | |
| | 510 mm | SH510 | — | 39 | — | 39 | |
| | 560 mm | SH560 | — | 39 | — | 39 | |
| Frame | Solid beech wood | natural | E-SKNB | • | • | • | • |
| | | stained | E-① | 19 | 19 | 19 | 19 |
| Backrest | Upholstered | BA-⑤ | • | • | • | • | |
| Seat | Upholstered | SE-⑤ | • | • | • | • | |
| Glides | Plastic | GD | • | • | • | • | |
| | Plastic with felt | GDF | 8 | 8 | 8 | 8 | |
| | Protect glides | GDT | 9 | 9 | 9 | 9 | |
| Foam | Standard foam | FSTD | • | • | • | • | |
| | Flame retardant foam | FFR2 | 10 | 10 | 19 | 19 | |
| | Flame retardant foam with fireproof fabric | FFRF | 46 | 46 | 59 | 59 | |
| Wood and wood-based materials | Raw material from certified forests, FSC certificate – authorized companies | FSC | • | • | • | • | |
| Wooden elements lacquering | Water lacquer UV | UV | • | • | • | • | |
| | Water lacquer | | - 20 | - 20 | - 20 | - 20 | |
| Assembly | Assembled | ASM-F | • | • | • | • | |

| | |
|--------------|---|
| Sample order | EMBLA FRAME CHAIR 4L UPH (SH460 E-SKNB BA-CPC11 SE-CPC23 GD FSTD FSC UV ASM-F) |
| | EMBLA FRAME CHAIR 4LA UPH (SH510 E-SKNB BA-MLF16 SE-MLF32 GD FFR2 FSC UV ASM-F) |

① – Please specify wood colour code – [see finishes](#)

⑤ – Please specify upholstery colour code from selected price group – [see finishes](#)

- Available as standard (included in basic price)

General notes

As standard, the upholstery type is the same for each upholstered element, colours may vary

PRICE GROUP 2: Cura, Cura Loop, Urban, Valencia, Xtreme
PRICE GROUP 3: Silvertex, Step/Step Melange
PRICE GROUP 4: Blazer, Main Line Flax, Oceanic, skai Parotega, Synergy
PRICE GROUP 5: Remix 3
PRICE GROUP 6: Nappa leather

Price list

Embla wooden chair on 4 legs

Seat and backrest made of beech plywood.
Frame made of solid beech wood and plywood,
with or without armrests, stackable, plastic glides.



| EMBLA FRAME CHAIR 4L W | EMBLA FRAME CHAIR 4LA W |
|---|---|
| W 520 mm D 545 mm H 780 mm SH 450 mm SH DIN 435 mm WT 5,3 kg | W 610 mm D 545 mm H 780 mm SH 450 mm SH DIN 435 mm WT 6,2 kg |
| Basic price (EUR) | |
| 369 | 446 |

| | | | | | | | | |
|--|---|--------------|--------|---------|---|-----|---|-----|
| Seat height | 465 mm | SH465 | | • | | • | | |
| Frame | Solid beech wood | natural | E-SKNB | | • | | • | |
| | | stained | E-① | 19 | | 19 | | |
| Backrest pad | Upholstered | Price group: | None | | • | • | • | • |
| | | | 2 | | | 45 | | 45 |
| | | | 3 | | | 52 | | 52 |
| | | | 4 | BA-PD-⑤ | – | 58 | – | 58 |
| | | | 5 | | | 64 | | 64 |
| | | | 6 | | | 95 | | 95 |
| Seat pad | Upholstered | Price group: | None | | • | – | • | – |
| | | | 2 | | | 66 | | 66 |
| | | | 3 | | | 71 | | 71 |
| | | | 4 | SE-PD-⑤ | – | 77 | – | 77 |
| | | | 5 | | | 81 | | 81 |
| | | | 6 | | | 130 | | 130 |
| Glides | Plastic | | GD | | • | | • | |
| | Plastic with felt | | GDF | 8 | | 8 | | |
| | Protect glides | | GDT | 9 | | 9 | | |
| Foam (applicable only for upholstered backrest pad, seat pad) | Standard foam | | FSTD | | • | | • | |
| | Flame retardant foam | | FFR2 | 10 | | 10 | | |
| | Flame retardant foam with fireproof fabric | | FFRF | 24 | | 46 | | |
| Wood and wood-based materials | Raw material from certified forests, FSC certificate – authorized companies | | FSC | | • | | • | |
| Wooden elements lacquering | Water lacquer UV | | UV | | • | | • | |
| | Water lacquer | | | –40 | | –40 | | |
| Assembly | Assembled | | ASM-F | | • | | • | |
| Sample order | EMBLA FRAME CHAIR 4L W (SH465 E-SKNB SE-PD-CPC05 GD FSTD FSC UV ASM-F) | | | | | | | |

① – Please specify wood colour code – see finishes

⑤ – Please specify upholstery colour code from selected price group – see finishes

• Available as standard (included in basic price)

General notes

As standard, the upholstery type is the same for each upholstered element, colours may vary

PRICE GROUP 2: Cura, Cura Loop, Urban, Valencia, Xtreme

PRICE GROUP 3: Silvertex, Step/Step Melange

PRICE GROUP 4: Blazer, Main Line Flax, Oceanic, skai Parotega, Synergy

PRICE GROUP 5: Remix 3

PRICE GROUP 6: Nappa leather

Finishes

Wood

Natural



SKNB
Natural
Beech

Stained



2.07Y
Black



2.06S
Slate



S39
Light Grey

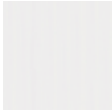

2.09S
White



2.0CB
Acacia



SK40
Oak



2.0CC
Walnut

General notes

All specified dimensions are approximate. Subject to minor modifications or differences for reasons of design improvements or for technical reasons.

- W = width
- D = depth
- H = height
- DI = diameter
- SH = seat height
- SH DIN = seat height measured acc. to DIN EN 1335-1

In compliance with the highest quality standards "Quality is irreplaceable." Guided by this principle, each product line is subjected to stringent quality testing.

Only the products marked in this document are FSC® (FSC®-C120977). Look for our FSC®-certified products. Sale of products that meet the FSC® requirements is possible only by Nowy Styl Sp. z o.o., Nowy Styl Nederland B.V. and Kusch + Co GmbH.



The FSC® certificate applies to responsible forest management and the entire flow of raw materials from the forest to the customer. Each stage of the chain is monitored in terms of social, ecological and economic performance. The product with the FSC® label gives customers a guarantee that the wood used for the production of the product comes from sources managed in a sustainable manner.

Warranty

Manufacturer declares that the products shall be free from defects in material or workmanship. The warranty is given to the original purchaser only, for normal commercial usage.

Detailed terms of warranty and warranty periods are available at

<https://www.kusch.com/en/warranty>

njord price list 2026

Njord

Design by Scaffidi & Johansen

Armchair on 4 wooden legs



NJORD ARMCHAIR 4L LGW FL

Table



NJORD TABLE LWM RD

Price list

Njord armchair on 4 wooden legs

Shell made of thermoformed polyester felt in anthracite colour, upholstered seat pad.
Frame made of solid beech wood, plastic glides.



NJORD ARMCHAIR 4L LGW FL

W 620 mm
D 530 mm
H 810 mm
SH 475 mm
SH DIN 470 mm
WT 5,5 kg

Basic price (EUR)
according to upholstery price group

| | |
|---------------|-----|
| Price group 2 | 584 |
| Price group 3 | 590 |
| Price group 4 | 598 |
| Price group 5 | 604 |
| Price group 6 | 682 |

| | | | | |
|--------------------------------------|---|---------|---------------------|-----|
| Frame | Beech wood | natural | E- ^① | • |
| | | stained | | 20 |
| | Oak wood | natural | | 89 |
| Shell | Anthracite felt | | BS-FK01 | • |
| Seat pad | Upholstered | | SE-PD- ^⑤ | • |
| Glides | Plastic | | GD | • |
| | Plastic with felt | | GDF | 8 |
| | Protect glides | | GDT | 9 |
| Foam | Standard foam | | FSTD | • |
| | Flame retardant foam | | FFR2 | 6 |
| Wood and wood-based materials | Raw material from certified forests, FSC certificate – authorized companies | | FSC | • |
| Wooden elements lacquering | Water lacquer UV | | UV | • |
| | Water lacquer | | | -20 |
| Assembly | Assembled | | ASM-F | • |

Sample order NJORD ARMCHAIR 4L LGW FL (E-SKNB BS-FK01 SE-PD-LDS74 FSTD FSC UV ASM-F)

^① – Please specify wood colour code – [see finishes](#)

^⑤ – Please specify upholstery colour code from selected price group – [see finishes](#)

- Available as standard (included in basic price)

PRICE GROUP 2: Cura, Cura Loop, Urban, Valencia, Xtreme
PRICE GROUP 3: Silvertex, Step/Step Melange
PRICE GROUP 4: Blazer, Main Line Flax, Skai Parotega, Synergy
PRICE GROUP 5: Remix 3
PRICE GROUP 6: Nappa leather

Price list

Njord table

Round table top.
Base: solid beech wood, metal connector, powder-coated,
plastic glides.



NJORD TABLE LWM RD

DI 380 mm
H 563/ 550 mm*
WT 3,4 kg

Basic price (EUR)
according to table top finishes

| | | | | | |
|-----------------------------|--|-------------------|----------|---------|-----|
| | Fenix NTM® | | | | 325 |
| Table top board core | Plywood | | PD | | • |
| Table top finish | Fenix NTM® | | ① | | • |
| | Connector | Base | | | |
| Base finish | Powder-coated steel in Jet black colour (RAL 9005) | Solid beech wood: | natural | BC-BK/① | • |
| | | | stained | | 15 |
| Glides | Plastic | | GD | | • |
| | Plastic with felt | | GDF | | ◦ |
| Assembly | Assembled, cardboard packaging | | PACK-ASM | | • |

Sample order NJORD TABLE LWM RD (PD KJ BC-BK/1.007 GDF PACK-ASM)

* x/y mm – x: overall height/y: height under table top

① – Please specify table top colour code – [see finishes](#)

- Available as standard (included in basic price)
- Available as an option (included in basic price)

Finishes for chair

Wood



SKNB
Natural
beech



SKNO
Natural
oak



2.0CC
Walnut



2.0CB
Acacia

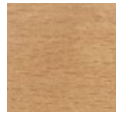

SK40
Oak



2.07Y
Black



2.06S
Slate



2.09S
White



SS39
Light grey

Polyester felt



FK01
anthracite
for seat shell
armchair

Metal



RAL 9005
Jet Black
BK

Finishes for table

Wood

Natural



SKNB
Natural
Beech

Stained



2.07Y
Black



2.06S
Slate



S39
Light Grey



2.09S
White



2.0CB
Acacia



SK40
Oak



2.0CC
Walnut

Fenix NTM®



KJ
Nero Ingo



KN
Grigio
Bromo



KM
Grigio
Antrim



KP
Rosso Jaipur



KR
Verde
Comodoro



KO
Blu Fes

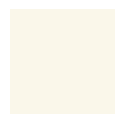

KS
Bianco Kos

Metal



RAL 9005
Jet Black
BK

General notes

All specified dimensions are approximate. Subject to minor modifications or differences for reasons of design improvements or for technical reasons.

- W = width
- D = depth
- H = height
- DI = diameter
- SH = seat height
- SH DIN = seat height measured acc. to DIN EN 1335-1

In compliance with the highest quality standards "Quality is irreplaceable." Guided by this principle, each product line is subjected to stringent quality testing.

Only the products marked in this document are FSC® (FSC®-C120977).
Look for our FSC®-certified products.
Sale of products that meet the FSC® requirements is possible only by Nowy Styl Sp. z o.o.,
Nowy Styl Nederland B.V. and Kusch + Co GmbH.



The mark of responsible forestry

The FSC® certificate applies to responsible forest management and the entire flow of raw materials from the forest to the customer. Each stage of the chain is monitored in terms of social, ecological and economic performance. The product with the FSC® label gives customers a guarantee that the wood used for the production of the product comes from sources managed in a sustainable manner.

Warranty

Manufacturer declares that the products shall be free from defects in material or workmanship. The warranty is given to the original purchaser only, for normal commercial usage.

Detailed terms of warranty and warranty periods are available at

<https://www.kusch.com/en/warranty>

scorpii price list 2026

Scorpii

Design by Uwe Sommerlade

Chair on 4 metal legs, plywood shell



SCORPII FRAME
CHAIR 4L W



SCORPII FRAME
CHAIR 4LA W

Chair on 4 metal legs, upholstered shell



SCORPII FRAME
CHAIR 4L
UPH



SCORPII FRAME
CHAIR 4LA
UPH



SCORPII FRAME
CHAIR 4L
HB UPH



SCORPII FRAME
CHAIR 4LA
HB UPH

Armchair on 4 metal legs



SCORPII
ARMCHAIR
4L TH



SCORPII
ARMCHAIR
4LA TH



SCORPII
ARMCHAIR
4LA



SCORPII
ARMCHAIR
4LA HB

Price list

Scorpii chair on 4 metal legs, plywood shell

Shell made of beech plywood.
Frame: 4 legs made of powder-coated or chromium plated steel, with or without armrests, stackable, plastic glides.

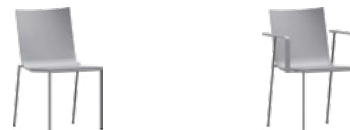

| SCORPII FRAME CHAIR 4L W | SCORPII FRAME CHAIR 4LA W |
|---|---|
| W 470 mm D 540 mm H 840 mm SH 450 mm SH DIN 430 mm WT 6 kg | W 550 mm D 540 mm H 840 mm SH 450 mm SH DIN 430 mm WT 7 kg |

Basic price (EUR)

| 280 | 487 |
|-----|-----|
|-----|-----|

| Frame | Steel | | E-③ | • | • | | | | |
|--------------|---------------|-----------------|---------|----|-----|-----|----|-----|-----|
| | | powder-coated | E-③ | • | • | | | | |
| | | chromium plated | E-③ | 24 | | | | 33 | |
| Shell | Beech plywood | natural | CC-① | • | • | | | | |
| | | stained | | 20 | | | 30 | | |
| | | natural | CC-HH-① | 22 | 22 | – | 22 | 22 | – |
| | | stained | | 42 | 42 | – | 51 | 51 | – |
| | None | | | • | • | – | • | • | – |
| Backrest pad | Upholstered | Price group 2 | BA-PD-⑤ | | | 99 | | | 99 |
| | | Price group 3 | | | | 103 | | | 103 |
| | | Price group 4 | | – | – | 112 | – | – | 112 |
| | | Price group 5 | | | | 118 | | | 118 |
| | | Price group 6 | | | | 184 | | | 184 |
| Seat pad | Upholstered | None | SE-PD-⑤ | • | – | – | • | – | – |
| | | Price group 2 | | | 62 | 62 | | 62 | 62 |
| | | Price group 3 | | | 67 | 67 | | 67 | 67 |
| | | Price group 4 | | – | 74 | 74 | – | 74 | 74 |
| | | Price group 5 | | | 81 | 81 | | 81 | 81 |
| | | Price group 6 | | | 127 | 127 | | 127 | 127 |

① – Please specify wood colour code – [see finishes](#)

③ – Please specify metal colour code – [see finishes](#)

⑤ – Please specify upholstery colour code from selected price group – [see finishes](#)

• Available as standard (included in basic price)

PRICE GROUP 2: Cura, Cura Loop, Valencia, Xtreme
PRICE GROUP 3: Silvertex, Step/Step Melange
PRICE GROUP 4: Blazer, Main Line Flax, skai Parotega, Synergy
PRICE GROUP 5: Remix 3
PRICE GROUP 6: Nappa leather

| | | | SCORPII FRAME CHAIR 4L W | | | SCORPII FRAME CHAIR 4LA W | | |
|--------------------------------------|--|-------|-----------------------------|----|----|------------------------------|----|----|
| Armrests | Beech armrests matching shell colour | ARF-① | — | | | • | | |
| Linking element | None | | • | | | • | | |
| Glides | Plastic | GD | • | | | • | | |
| | Plastic with felt | GDF | 8 | | | 8 | | |
| Foam | Standard foam | FSTD | — | • | • | — | • | • |
| | Flame retardant foam | FFR2 | | 8 | 11 | | 8 | 11 |
| | Flame retardant foam with fireproof fabric | FFRF | | 39 | 72 | | 39 | 72 |
| Wood and wood-based materials | Raw material - EU Timber regulation | EUTR | • | | | • | | |
| Wooden elements lacquering | Water lacquer UV | UV | • | | | • | | |
| | Water lacquer | | - 20 | | | - 20 | | |
| Sample order | SCORPII FRAME CHAIR 4L W (E-WK CC-SKNB GD EUTR UV) | | | | | | | |

① – Please specify wood colour code – [see finishes](#)

- Available as standard (included in basic price)

Price list

Scorpii frame chair on 4 metal legs, upholstered shell

Upholstered shell.
Frame on 4 legs made of powder-coated or chromium plated steel, with or without armrests, stackable, plastic glides.



| SCORPII FRAME CHAIR 4L UPH | SCORPII FRAME CHAIR 4LA UPH |
|---|---|
| W 470 mm D 540 mm H 840 mm SH 450 mm SH DIN 440 mm WT 8 kg | W 550 mm D 540 mm H 840 mm SH 450 mm SH DIN 440 mm WT 9 kg |

Basic price (EUR) according to upholstery price group

| | | | | |
|--------------------------------------|--|-----------------|------|-----|
| | Price group 2 | | 398 | 604 |
| | Price group 3 | | 417 | 623 |
| | Price group 4 | | 442 | 648 |
| | Price group 5 | | 459 | 667 |
| | Price group 6 | | 603 | 810 |
| Frame | Steel | powder-coated | E-③ | • |
| | | chromium plated | E-③ | 24 |
| Shell | Upholstered | | BS-⑤ | • |
| Armrests | Beech armrests | | | • |
| | stained armrests | ARF-① | — | 10 |
| Linking element | None | | | • |
| Glides | Plastic | GD | | • |
| | Plastic with felt | GDF | 8 | 8 |
| Foam | Standard foam | FSTD | | • |
| | Flame retardant foam | FFR2 | 11 | 11 |
| | Flame retardant foam with fireproof fabric | FFRF | 104 | 104 |
| Wood and wood-based materials | Raw material - EU Timber regulation | EUTR | | • |
| Wooden elements lacquering | Water lacquer UV | UV | — | • |
| | Water lacquer | | — | ◦ |

Sample order SCORPII FRAME CHAIR 4L UPH (E-WK BS-CPC10 GD FSTD EUTR)

- ① – Please specify wood colour code – [see finishes](#)
 ③ – Please specify metal colour code – [see finishes](#)
 ⑤ – Please specify upholstery colour code from selected price group – [see finishes](#)

- Available as standard (included in basic price)
- Available as an option (included in basic price)

PRICE GROUP 2: Cura, Cura Loop, Valencia, Xtreme
 PRICE GROUP 3: Silvertex, Step/Step Melange
 PRICE GROUP 4: Blazer, Main Line Flax, skai Parotega, Synergy
 PRICE GROUP 5: Remix 3
 PRICE GROUP 6: Nappa leather

Scorpii frame chair on 4 metal legs, upholstered shell with high backrest

Shell with high backrest, upholstered.
Frame on 4 legs made of powder-coated or chromium plated steel, with or without wooden armrests, stackable, plastic glides.



**SCORPII FRAME CHAIR
4L HB UPH**

W 470 mm
D 570 mm
H 940 mm
SH 450 mm
SH DIN 440 mm
WT 8 kg

**SCORPII FRAME CHAIR
4LA HB UPH**

W 550 mm
D 570 mm
H 940 mm
SH 450 mm
SH DIN 440 mm
WT 9 kg

Basic price (EUR) according to upholstery price group

| | | | | 4L HB UPH | 4LA HB UPH |
|--------------------------------------|--|-----------------|-------|-----------|------------|
| | Price group 2 | | | 487 | 695 |
| | Price group 3 | | | 504 | 711 |
| | Price group 4 | | | 530 | 734 |
| | Price group 5 | | | 546 | 751 |
| | Price group 6 | | | 699 | 907 |
| Frame | Steel | powder-coated | E-③ | • | • |
| | | chromium plated | E-③ | 24 | 33 |
| Shell | Upholstered | | BS-⑤ | • | • |
| Armrests | Beech | | | — | • |
| | Stained beech | | ARF-① | — | 10 |
| Linking element | None | | | • | • |
| Glides | Plastic | | GD | • | • |
| | Plastic with felt | | GDF | 8 | 8 |
| Foam | Standard foam | | FSTD | • | • |
| | Flame retardant foam | | FFR2 | 11 | 11 |
| | Flame retardant foam with fireproof fabric | | FFRF | 104 | 104 |
| Wood and wood-based materials | Raw material - EU Timber regulation | | EUTR | • | • |
| Wooden elements lacquering | Water lacquer UV | | UV | — | • |
| | Water lacquer | | | — | o |
| Sample order | SCORPII FRAME CHAIR 4L HB UPH (E-WK BS-CPC11 GD FSTD EUTR) | | | | |

① – Please specify wood colour code – [see finishes](#)

③ – Please specify metal colour code – [see finishes](#)

⑤ – Please specify upholstery colour code from selected price group – [see finishes](#)

• Available as standard (included in basic price)

o Available as an option (included in basic price)

PRICE GROUP 2: Cura, Cura Loop, Valencia, Xtreme
PRICE GROUP 3: Silvertex, Step/Step Melange
PRICE GROUP 4: Blazer, Main Line Flax, skai Parotega, Synergy
PRICE GROUP 5: Remix 3
PRICE GROUP 6: Nappa leather

Price list

Scorpil armchair on 4 metal legs

Upholstered shell.
Frame on 4 legs made of powder-coated or chromium plated steel, with or without armrests



| SCORPII ARMCHAIR 4L TH | SCORPII ARMCHAIR 4LA TH |
|---|---|
| W 630 mm D 680 mm H 820 mm SH 450 mm WT 12,5 kg | W 670 mm D 680 mm H 820 mm SH 450 mm WT 15,5 kg |

Basic price (EUR) according to upholstery price group

| | | | | |
|--------------------------------------|--|-----------------|--------------------|----------------------------------|
| | Price group 2 | | 711 | 935 |
| | Price group 3 | | 738 | 965 |
| | Price group 4 | | 775 | 1000 |
| | Price group 5 | | 802 | 1026 |
| | Price group 6 | | 1012 | 1236 |
| Seat height | 450 mm | | — | • |
| | 500 mm | | | 45 |
| Frame | Steel | powder-coated | E- ^③ | • |
| | | chromium plated | E- ^③ | 36 |
| Shell | Upholstered | | BS- ^⑤ | • |
| Armrests | Back connector | Cover | Aluminium polished | ARF- ^③ / ^④ |
| | | | | |
| | Chrome | | | 28 |
| Glides | Plastic | | GD | • |
| | Plastic with felt | | GDF | 8 |
| Foam | Standard foam | | FSTD | • |
| | Flame retardant foam | | FFR2 | 21 |
| | Flame retardant foam with fireproof fabric | | FFRF | 207 |
| Wood and wood-based materials | Raw material - EU Timber regulation | | EUTR | • |

Sample order SCORPII ARMCHAIR 4L TH (E-WK BS-CPC10 GD FSTD EUTR)

- ③ – Please specify metal colour code – [see finishes](#)
- ④ – Please specify plastic colour code – [see finishes](#)
- ⑤ – Please specify upholstery colour code from selected price group – [see finishes](#)
- Available as standard (included in basic price)

PRICE GROUP 2: Cura, Cura Loop, Valencia, Xtreme
PRICE GROUP 3: Silvertex, Step/Step Melange
PRICE GROUP 4: Blazer, Main Line Flax, skai Parotega, Synergy
PRICE GROUP 5: Remix 3
PRICE GROUP 6: Nappa leather

Scorpil armchair on 4 metal legs

Upholstered shell, two backrest heights available.
Upholstered armrests.
Frame on 4 legs, made of powder-coated or chromium plated steel, plastic glides.



**SCORPII ARMCHAIR
4LA**

W 620 mm
D 650 mm
H 820 mm
SH 450 mm
WT 15,5 kg

**SCORPII ARMCHAIR
4LA HB**

W 620 mm
D 680 mm
H 920 mm
SH 450 mm
WT 16 kg

Basic price (EUR) according to upholstery price group

| | | | 986 | 1040 | |
|--------------------------------------|--|-----------------|-------|------|-----|
| | Price group 2 | | | | |
| | Price group 3 | | 1023 | 1076 | |
| | Price group 4 | | 1076 | 1125 | |
| | Price group 5 | | 1113 | 1161 | |
| | Price group 6 | | 1500 | 1539 | |
| Frame | Steel | powder-coated | E-③ | • | • |
| | | chromium plated | E-③ | 36 | 36 |
| Shell | Upholstered | | BS-⑤ | • | • |
| Armrests | Upholstered | | ARF-⑤ | • | • |
| Glides | Plastic | | GD | • | • |
| | Plastic with felt | | GDF | 8 | 8 |
| Foam | Standard foam | | FSTD | • | • |
| | Flame retardant foam | | FFR2 | 22 | 22 |
| | Flame retardant foam with fireproof fabric | | FFRF | 346 | 346 |
| Wood and wood-based materials | Raw material - EU Timber regulation | | EUTR | • | • |

Sample order SCORPII ARMCHAIR 4LA TH (E-WK BS-CPC10 ARF-CPC10 GD FSTD EUTR)

③ – Please specify metal colour code – [see finishes](#)

⑤ – Please specify upholstery colour code from selected price group – [see finishes](#)

- Available as standard (included in basic price)

Finishes

Wood

Natural



SKNB
Natural
Beech

Stained



2.07Y
Black



2.06S
Slate



S39
Light Grey



2.09S
White



2.0CB
Acacia



SK40
Oak



2.0CC
Walnut

Metal



**NCS S
2005-Y60R**
Cashmere
NK



RAL 1024
Ochre Yellow
OY



**RAL 030
50 40**
Vermilion
Red
VR



RAL 6003
Olive Green
OG



RAL 5000
Violet Blue
VB



Chrome
CR



RAL 9005
Jet Black
BK



RAL 9006
White
Aluminium
WK

General notes

All specified dimensions are approximate. Subject to minor modifications or differences for reasons of design improvements or for technical reasons.

- W = width
- D = depth
- H = height
- DI = diameter
- SH = seat height
- SH DIN = seat height measured acc. to DIN EN 1335-1

In compliance with the highest quality standards "Quality is irreplaceable." Guided by this principle, each product line is subjected to stringent quality testing.

Warranty

Manufacturer declares that the products shall be free from defects in material or workmanship. The warranty is given to the original purchaser only, for normal commercial usage. Detailed terms of warranty and warranty periods are available at <https://www.kusch.com/en/warranty>

Yara

Design by Jorge Pensi

Chair on 4 wooden legs



**YARA FRAME
CHAIR 4L UPH**



**YARA FRAME
CHAIR 4LA UPH**



**YARA FRAME
CHAIR 4L HB UPH**



**YARA FRAME
CHAIR 4LA HB
UPH**

Price list

Yara chair on 4 wooden legs

Upholstered shell.
Frame on 4 legs made of solid beech wood, with or without armrests, plastic glides. Stackable.



| YARA FRAME CHAIR 4L UPH | YARA FRAME CHAIR 4LA UPH |
|---|---|
| W 530 mm D 600 mm H 860 mm SH 450 mm SH DIN 425 mm WT 6,5 kg | W 630 mm D 600 mm H 860 mm SH 450 mm SH DIN 425 mm WT 7,5 kg |

| | | | Basic price (EUR) according to upholstery price group | |
|--------------------------------------|---|---------|---|------|
| | Price group 2 | | 540 | 623 |
| | Price group 3 | | 560 | 644 |
| | Price group 4 | | 587 | 669 |
| | Price group 5 | | 607 | 687 |
| | Price group 6 | | 792 | 867 |
| Frame | Solid beech wood | natural | • | • |
| | | stained | 20 | 20 |
| Shell | Upholstered | BS-⑤ | • | • |
| Glides | Plastic | GD | • | • |
| | Plastic with felt | GDF | 8 | 8 |
| | Protect glides | GDT | 9 | 9 |
| Foam | Standard foam | FSTD | • | • |
| | Flame retardant foam | FFR2 | 11 | 11 |
| | Flame retardant foam with fireproof fabric | FFRF | 201 | 201 |
| Wood and wood-based materials | Raw material from certified forests, FSC certificate – authorized companies | FSC | • | • |
| Wooden elements lacquering | Water lacquer UV | UV | • | • |
| | Water lacquer | | - 20 | - 20 |

Sample order YARA FRAME CHAIR 4L UPH (E-SKNB BS-XR009 GDF FSTD FSC UV)

① – Please specify wood colour code – [see finishes](#)

⑤ – Please specify upholstery colour code from selected price group – [see finishes](#)

• Available as standard (included in basic price)

PRICE GROUP 2: Cura, Cura Loop, Valencia, Xtreme
PRICE GROUP 3: Silvertex, Step/Step Melange
PRICE GROUP 4: Blazer, Main Line Flax, Oceanic, skai Parotega, Synergy
PRICE GROUP 5: Remix 3
PRICE GROUP 6: Nappa leather

Price list

Yara chair on 4 wooden legs with high backrest

Upholstered shell.
Frame on 4 legs made of solid beech wood, with or without armrests, plastic glides. Stackable.



**YARA FRAME CHAIR
4L HB UPH**

W 530 mm
D 630 mm
H 960 mm
SH 450 mm
SH DIN 425 mm
WT 7 kg

**YARA FRAME CHAIR
4LA HB UPH**

W 630 mm
D 630 mm
H 960 mm
SH 450 mm
SH DIN 425 mm
WT 8 kg

Basic price (EUR) according to upholstery price group

| | | | | 548 | 647 |
|--------------------------------------|---|---------|------------------|------|------|
| | Price group 2 | | | | |
| | Price group 3 | | | 570 | 668 |
| | Price group 4 | | | 598 | 696 |
| | Price group 5 | | | 617 | 717 |
| | Price group 6 | | | 834 | 933 |
| Frame | Solid beech wood | natural | E- ^① | • | • |
| | | stained | | 20 | 20 |
| Shell | Upholstered | | BS- ^⑤ | • | • |
| Glides | Plastic | | GD | • | • |
| | Plastic with felt | | GDF | 8 | 8 |
| | Protect glides | | GDT | 9 | 9 |
| Foam | Standard foam | | FSTD | • | • |
| | Flame retardant foam | | FFR2 | 11 | 11 |
| | Flame retardant foam with fireproof fabric | | FFRF | 258 | 258 |
| Wood and wood-based materials | Raw material from certified forests, FSC certificate – authorized companies | | FSC | • | • |
| Wooden elements lacquering | Water lacquer UV | | UV | • | • |
| | Water lacquer | | | - 20 | - 20 |

Sample order YARA FRAME CHAIR 4L HB UPH (E-SKNB BS-CUR66167 GDF FSTD FSC UV)

^① – Please specify wood colour code – [see finishes](#)

^⑤ – Please specify upholstery colour code from selected price group – [see finishes](#)

• Available as standard (included in basic price)

PRICE GROUP 2: Cura, Cura Loop, Valencia, Xtreme
PRICE GROUP 3: Silvertex, Step/Step Melange
PRICE GROUP 4: Blazer, Main Line Flax, Oceanic, skai Parotega, Synergy
PRICE GROUP 5: Remix 3
PRICE GROUP 6: Nappa leather

Finishes

Wood

Natural



SKNB
Natural
Beech

Stained



2.07Y
Black



2.06S
Slate



S39
Light Grey

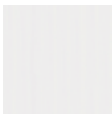

2.09S
White



2.0CB
Acacia



SK40
Oak



2.0CC
Walnut

General notes

All specified dimensions are approximate. Subject to minor modifications or differences for reasons of design improvements or for technical reasons.

- W = width
- D = depth
- H = height
- DI = diameter
- SH = seat height
- SH DIN = seat height measured acc. to DIN EN 1335-1

In compliance with the highest quality standards "Quality is irreplaceable." Guided by this principle, each product line is subjected to stringent quality testing.

Only the products marked in this document are FSC® (FSC®-C120977). Look for our FSC®-certified products. Sale of products that meet the FSC® requirements is possible only by Nowy Styl Sp. z o.o., Nowy Styl Nederland B.V. and Kusch + Co GmbH.



The FSC® certificate applies to responsible forest management and the entire flow of raw materials from the forest to the customer. Each stage of the chain is monitored in terms of social, ecological and economic performance. The product with the FSC® label gives customers a guarantee that the wood used for the production of the product comes from sources managed in a sustainable manner.

Warranty

Manufacturer declares that the products shall be free from defects in material or workmanship. The warranty is given to the original purchaser only, for normal commercial usage. Detailed terms of warranty and warranty periods are available at <https://www.kusch.com/en/warranty>

arn
price list
2026

Arn

Design: Scaffidi & Johansen

Chair on 4 wooden legs



ARN FRAME
CHAIR 4L
LGW P

ARN FRAME
CHAIR 4L
LGW HB P

Chair on 4 wooden legs, upholstered seat



ARN FRAME
CHAIR 4L LGW
UPH

ARN FRAME
CHAIR 4L LGW
HB UPH

Arn bar hocker on 4 wooden legs



ARN FRAME
CHAIR HKR 4L
LGW P

ARN FRAME
CHAIR HKR 4L
LGW UPH

Chair on 4 metal legs



ARN FRAME
CHAIR 4L LGM P

ARN FRAME
CHAIR 4L LGM
HB P

Chair on 4 metal legs, upholstered seat



ARN FRAME
CHAIR 4L
LGM UPH

ARN FRAME
CHAIR 4L
LGM HB UPH

Price list

Arn chair on 4 wooden legs

Seat and backrest made of plastic, with high antibacterial properties.
 Chair design adapted to hygiene requirements.
 All surfaces easily accessible for cleaning or disinfection.
 Frame: 4 legs made of solid beech wood mounted to plastic chassis, with or without armrests, stackable, plastic glides.



| | | | ARN FRAME CHAIR 4L LGW P | ARN FRAME CHAIR 4L LGW HB P |
|--------------------------------------|---|---------|---|---|
| | | | W 490 mm D 530 mm H 820 mm SH 450 mm SH DIN 445 mm WT 5,5 kg | W 500 mm D 580 mm H 900 mm SH 450 mm SH DIN 430 mm WT 6,0 kg |
| | | | Basic price (EUR) | |
| | | | 259 | 314 |
| Legs | Beech wood | natural | • | • |
| | | stained | E-① | 19 |
| | Oak wood | natural | 49 | 49 |
| Backrest, seat, chassis | Plastic | CC-④ | • | • |
| Armrests | No armrests | | • | • |
| | Plastic armrests in chassis colour | ARM-④ | 56 | 56 |
| Glides | Plastic | GD | • | • |
| | Plastic with felt | GDF | 8 | 8 |
| | Protect glides | GDT | 9 | 9 |
| Wood and wood-based materials | Raw material from certified forests, FSC certificate – authorized companies | FSC | • | • |
| Varnishing of wooden elements | Water lacquer UV | UV | • | • |
| | Water lacquer | | -40 | -40 |
| Assembly | Assembled | ASM-F | • | • |
| Sample order | ARN FRAME CHAIR 4L LGW P (E-SKNB CC-KT15 GD FSC UV ASM-F) | | | |

① – Please specify wood colour code – [see finishes](#)

④ – Please specify plastic elements finish – [see finishes](#)

• Available as standard (included in basic price)

Price list

Arn chair on 4 wooden legs, upholstered seat

Upholstered seat, plastic backrest, with high antibacterial properties.
Chair design adapted to hygiene requirements.
All surfaces easily accessible for cleaning or disinfection.
Frame: 4 legs made of solid beech wood mounted to plastic chassis, with or without armrests, stackable, plastic glides.



| ARN FRAME CHAIR 4L LGW UPH | ARN FRAME CHAIR 4L LGW HB UPH |
|----------------------------|-------------------------------|
|----------------------------|-------------------------------|

| | |
|---|---|
| W 490 mm D 540 mm H 820 mm SH 460 mm SH DIN 450 mm WT 6,0 kg | W 500 mm D 580 mm H 900 mm SH 450 mm SH DIN 430 mm WT 6,0 kg |
|---|---|

Basic price (EUR)
according to upholstery price group

| | | | | | | |
|--------------------------|------------------------------------|-------------|---------|-----|-----|-----|
| | Price group 2 | | | 304 | 360 | |
| | Price group 3 | | | 308 | 365 | |
| | Price group 4 | | | 319 | 376 | |
| | Price group 5 | | | 325 | 382 | |
| | Price group 6 | | | 368 | 429 | |
| Legs | Beech wood | natural | E-① | • | • | |
| | | stained | | 19 | 19 | |
| | Oak wood | natural | | 49 | 49 | |
| Backrest, chassis | Plastic | | CC-④ | • | • | |
| Backrest pad | None | | | • | — | |
| | Upholstered | Price group | BA-PD-⑤ | 2 | 58 | 74 |
| | | | | 3 | 62 | 78 |
| | | | | 4 | 65 | 83 |
| | | | | 5 | 68 | 85 |
| | | | | 6 | 113 | 133 |
| | | | — | — | | |
| Seat | Upholstered | | SE-⑤ | • | • | |
| | Upholstered, comfort upholstery | | SE-CM-⑤ | 33 | 33 | |
| Armrests | None | | | • | • | |
| | Plastic armrests in chassis colour | | ARM-④ | 56 | 56 | |

① – Please specify wood colour code – [see finishes](#)

④ – Please specify plastic elements finish – [see finishes](#)

⑤ – Please specify upholstery colour code from selected price group – [see finishes](#)

• Available as standard (included in basic price)

PRICE GROUP 2: Cura, Cura Loop, Urban, Valencia, Xtreme
PRICE GROUP 3: Silvertex, Step/Step Melange
PRICE GROUP 4: Blazer, Main Line Flax, Oceanic, skai Parotega, Synergy
PRICE GROUP 5: Remix 3
PRICE GROUP 6: Nappa leather

| | | | ARN FRAME CHAIR 4L LGW UPH | | ARN FRAME CHAIR 4L LGW HB UPH | |
|--------------------------------------|--|-------|-------------------------------|----|----------------------------------|----|
| Glides | Plastic | GD | • | | • | |
| | Plastic with felt | GDF | 8 | | 8 | |
| | Protect glides | GDT | 9 | | 9 | |
| Foam | Flame retardant foam | FFR2 | • | • | • | • |
| | Flame retardant foam with fireproof fabric | FFRF | 33 | 52 | 33 | 52 |
| Wood and wood-based materials | Raw material from certified forests, FSC certificate – authorized companies | FSC | • | | • | |
| Varnishing of wooden elements | Water lacquer UV | UV | • | | • | |
| | Water lacquer | | -40 | | -40 | |
| Assembly | Assembled | ASM-F | • | | • | |
| Sample order | ARN FRAME CHAIR 4L LGW UPH (E-AB-SKNB CC-KT15 SE-CPC10 GD FFR2 FSC UV ASM-F) | | | | | |

- Available as standard (included in basic price)

Price list

Arn bar hocker on 4 wooden legs

Seat and backrest made of plastic, with high antibacterial properties.
 Chair design adapted to hygiene requirements.
 All surfaces easily accessible for cleaning or disinfection.
 Frame: 4 legs made of solid beech wood mounted to plastic chassis,
 footrest made of chromium plated steel, without armrests, stackable, plastic glides.



ARN FRAME CHAIR HKR 4L LGW P

W 540 mm
 D 555 mm
 H 1190 mm
 SH 825 mm
 SH DIN 820 mm
 WT 8,2 kg

Basic price (EUR)
 according to upholstery price group

497

| | | | | |
|--------------------------------------|---|---------|------------------|-----|
| Legs | Beech wood | natural | E- ^① | • |
| | | stained | | 19 |
| | Oak wood | natural | | 49 |
| Backrest, seat chassis | Plastic | | CC- ^④ | • |
| | Plastic | | GD | • |
| Glides | Plastic with felt | | GDF | 8 |
| | Protect glides | | GDT | 9 |
| | | | | |
| Wood and wood-based materials | Raw material from certified forests, FSC certificate – authorized companies | | FSC | • |
| Varnishing of wooden elements | Water lacquer UV | | UV | • |
| | Water lacquer | | | -40 |
| Assembly | Assembled | | ASM-F | • |

Sample order ARN FRAME CHAIR HKR 4L LGW P (E-SKNB CC-KT15 GD FSC UV ASM-F)

^① – Please specify wood colour code – [see finishes](#)

^④ – Please specify plastic elements finish – [see finishes](#)

• Available as standard (included in basic price)

Arn bar hocker on 4 wooden legs, upholstered seat

Upholstered seat, plastic backrest, with high antibacterial properties.
 Chair design adapted to hygiene requirements.
 All surfaces easily accessible for cleaning or disinfection.
 Frame: 4 legs made of solid beech wood mounted to plastic chassis,
 footrest made of chromium plated steel, without armrests, stackable, plastic glides.



ARN FRAME CHAIR HKR 4L LGW UPH

W 540 mm
 D 555 mm
 H 1190 mm
 SH 835 mm
 SH DIN 825 mm
 WT 8,7 kg

| | | | | Basic price (EUR) according to upholstery price group | |
|--------------------------------------|---|-------------|-------|--|-----|
| | Price group 2 | | | | 541 |
| | Price group 3 | | | | 548 |
| | Price group 4 | | | | 555 |
| | Price group 5 | | | | 562 |
| | Price group 6 | | | | 606 |
| Legs | Beech wood | natural | | | • |
| | | stained | E-① | | 19 |
| | Oak wood | natural | | | 49 |
| Backrest, chassis | Plastic | | CC-④ | | • |
| | None | | | | • |
| Backrest pad | Upholstered | Price group | 2 | BA-PD-⑤ | 58 |
| | | | 3 | | 62 |
| | | | 4 | | 65 |
| | | | 5 | | 68 |
| | | | 6 | | 113 |
| | | | | | |
| Seat | Upholstered | | SE-⑤ | | • |
| | Plastic | | GD | | • |
| Glides | Plastic with felt | | GDF | | 8 |
| | Protect glides | | GDT | | 9 |
| Foam | Flame retardant foam | | FFR2 | | • |
| | Flame retardant foam with fireproof fabric | | FFRF | 33 | 52 |
| Wood and wood-based materials | Raw material from certified forests, FSC certificate – authorized companies | | FSC | | • |
| Varnishing of wooden elements | Water lacquer UV | | UV | | • |
| | Water lacquer | | | | -40 |
| Assembly | Assembled | | ASM-F | | • |
| Sample order | ARN FRAME CHAIR HKR 4L LGW UPH (E-SKNB CC-KT15 SE-CPC23 GD FFR2 FSC UV ASM-F) | | | | |

① – Please specify wood colour code – [see finishes](#)

④ – Please specify plastic elements finish – [see finishes](#)

• Available as standard (included in basic price)

PRICE GROUP 2: Cura, Cura Loop, Urban, Valencia, Xtreme
 PRICE GROUP 3: Silvertex, Step/Step Melange
 PRICE GROUP 4: Blazer, Main Line Flax, Oceanic, skai Parotega, Synergy
 PRICE GROUP 5: Remix 3
 PRICE GROUP 6: Nappa leather

Price list

Arn chair on 4 metal legs

Seat and backrest made of plastic, with high antibacterial properties.
 Chair design adapted to hygiene requirements.
 All surfaces easily accessible for cleaning or disinfection.
 Frame: 4 anodized or powder-coated aluminium legs,
 mounted to plastic chassis, with or without armrests, stackable, plastic glides.



| ARN FRAME CHAIR 4L LGM P | ARN FRAME CHAIR 4L LGM HB P |
|---|---|
| W 490 mm D 530 mm H 815 mm SH 450 mm SH DIN 445 mm WT 5,9 kg | W 500 mm D 580 mm H 900 mm SH 450 mm SH DIN 430 mm WT 6,0 kg |

Basic price (EUR)

| | | | 225 | 276 |
|--------------------------------|--|---------------------|-----|-----|
| Seat height | 450 mm | SH450 | • | • |
| | 500 mm | SH500 | 45 | 45 |
| | 550 mm | SH550 | | |
| Legs | Aluminium | powder-coated | • | • |
| | | anodised mat silver | 11 | 11 |
| | | bright anodised | | |
| Backrest, seat, chassis | Plastic | CC-④ | • | • |
| Armrests | No armrests | | • | • |
| | Plastic armrests in chassis colour | ARM-④ | 56 | 56 |
| Glides | Plastic | GD | • | • |
| | Plastic with felt | GDF | 8 | 8 |
| | Protect glides | GDT | 18 | 18 |
| Assembly | Assembled | ASM-F | • | • |
| Sample order | ARN FRAME CHAIR 4L LGM P (SH450 E-ASAM CC-KT15 GD ASM-F) | | | |

③ – Please specify metal colour code – [see finishes](#)

④ – Please specify plastic colour code – [see finishes](#)

• Available as standard (included in basic price)

Arn chair on 4 metal legs, upholstered seat

Upholstered seat, plastic backrest, with high antibacterial properties.
 Chair design adapted to hygiene requirements.
 All surfaces easily accessible for cleaning or disinfection.
 Frame: 4 anodized or powder-coated aluminium legs,
 mounted to plastic chassis, with or without armrests, stackable, plastic glides.



| ARN FRAME CHAIR 4L LGM UPH | ARN FRAME CHAIR 4L LGM HB UPH |
|---|---|
| W 490 mm D 540 mm H 815 mm SH 460 mm SH DIN 450 mm WT 6,4 kg | W 500 mm D 580 mm H 900 mm SH 450 mm SH DIN 440 mm WT 6,5 kg |

Basic price (EUR)
 according to upholstery price group

| | | | | Price group 2 | | Price group 3 | | Price group 4 | | Price group 5 | | Price group 6 | | |
|--------------------------|---------------------------------|---------------------|---------|---------------|---|---------------|----|---------------|----|---------------|--|---------------|--|--|
| | | | | 268 | | 320 | | | | | | | | |
| | | | | 272 | | 326 | | | | | | | | |
| | | | | 283 | | 334 | | | | | | | | |
| | | | | 288 | | 342 | | | | | | | | |
| | | | | 332 | | 388 | | | | | | | | |
| Seat height | 450 mm | | SH450 | • | | • | | | | | | | | |
| | 500 mm | | SH500 | 45 | | 45 | | | | | | | | |
| | 550 mm | | SH550 | | | | | | | | | | | |
| Legs | Aluminium | powder-coated | | • | | • | | | | | | | | |
| | | anodised mat silver | | E-③ | | 11 | | 11 | | | | | | |
| | | bright anodised | | | | | | | | | | | | |
| Backrest, chassis | Plastic | | CC-④ | • | | • | | | | | | | | |
| | None | | | • | | - | | • | | - | | | | |
| Backrest pad | Upholstered | Price group | 2 | | | 58 | | 74 | | | | | | |
| | | | 3 | | | 62 | | 78 | | | | | | |
| | | | 4 | BA-PD-⑤ | - | | 65 | | 83 | | | | | |
| | | | 5 | | | 68 | | 85 | | | | | | |
| | | | 6 | | | 113 | | 133 | | | | | | |
| | | | | | | | | | | | | | | |
| Seat | Upholstered | | SE-⑤ | • | | • | | | | | | | | |
| | Upholstered, comfort upholstery | | SE-CM-⑤ | 33 | | 33 | | | | | | | | |

- ③ – Please specify metal colour code – [see finishes](#)
- ④ – Please specify plastic elements finish – [see finishes](#)
- ⑤ – Please specify upholstery colour code from selected price group – [see finishes](#)

• Available as standard (included in basic price)

PRICE GROUP 2: Cura, Cura Loop, Urban, Valencia, Xtreme
 PRICE GROUP 3: Silvertex, Step/Step Melange
 PRICE GROUP 4: Blazer, Main Line Flax, Oceanic, skai Parotega, Synergy
 PRICE GROUP 5: Remix 3
 PRICE GROUP 6: Nappa leather

Price list

| | | | ARN FRAME CHAIR 4L LGM UPH | | ARN FRAME CHAIR 4L LGM HB UPH | |
|--------------------------------------|---|-------|-------------------------------|----|----------------------------------|----|
| Armrests | None | | • | | • | |
| | Plastic armrests in chassis colour | ARM-④ | 56 | | 56 | |
| Glides | Plastic | GD | • | | • | |
| | Plastic with felt | GDF | 8 | | 8 | |
| | Protect glides | GDT | 18 | | 18 | |
| Foam | Flame retardant foam | FFR2 | • | • | • | • |
| | Flame retardant foam with fireproof fabric | FFRF | 33 | 52 | 33 | 52 |
| Wood and wood-based materials | Raw material from certified forests, FSC certificate – authorized companies | FSC | – | | – | • |
| Assembly | Assembled | ASM-F | • | | • | |
| Sample order | ARN FRAME CHAIR 4L LGM UPH (SH450 E-ASAM CC-KT15 SE-CPC10 GD FFR2 ASM-F) | | | | | |

④ – Please specify plastic elements finish – [see finishes](#)

- Available as standard (included in basic price)

Finishes

Wood

Natural



SKNB
Natural
Beech



SKNO
Natural Oak

Stained



2.07Y
Black



2.06S
Slate



S39
Light Grey



2.09S
White



2.0CB
Acacia



SK40
Oak



2.0CC
Walnut

Metal



**NCS S
2005-Y60R**
Cashmere
NK



RAL 1024
Ochre Yellow
OY



**RAL 030
50 40**
Vermilion
Red
VR



RAL 6003
Olive Green
OG



RAL 5000
Violet Blue
VB



**Anodised
Aluminium
Silver matt**
ASAM



**Anodised
Aluminium
Silver
bright**
ASAG



RAL 9003
Signal White
WS



RAL 9006
White
Aluminium
WK



Silk
KSK



Silver 98
SV



DB 703
Iron Mica
IM



RAL 9005
Jet Black
BK

Metal

for footrest



Chrome
CR

Plastic



KG
Black Grey



KY
Light Grey



KQ
Quartz Grey



KK
Silk

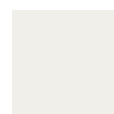

KW
Signal White



KT
Tinkerbell

General notes

All specified dimensions are approximate. Subject to minor modifications or differences for reasons of design improvements or for technical reasons.

- W = width
- D = depth
- H = height
- DI = diameter
- SH = seat height
- SH DIN = seat height measured acc. to DIN EN 1335-1

In compliance with the highest quality standards "Quality is irreplaceable." Guided by this principle, each product line is subjected to stringent quality testing.

Only the products marked in this document are FSC® (FSC®-C120977). Look for our FSC®-certified products. Sale of products that meet the FSC® requirements is possible only by Nowy Styl Sp. z o.o., Nowy Styl Nederland B.V. and Kusch + Co GmbH.



The mark of responsible forestry

The FSC® certificate applies to responsible forest management and the entire flow of raw materials from the forest to the customer. Each stage of the chain is monitored in terms of social, ecological and economic performance. The product with the FSC® label gives customers a guarantee that the wood used for the production of the product comes from sources managed in a sustainable manner.

Warranty

Manufacturer declares that the products shall be free from defects in material or workmanship. The warranty is given to the original purchaser only, for normal commercial usage. Detailed terms of warranty and warranty periods are available at <https://www.kusch.com/en/warranty>

bound price list 2026

Bound

Design by: Karim Rashid

Armchair



BOUND ARMCHAIR SWIVEL CO KO

Sofa



BOUND SOFA CO KO

Table



BOUND TABLE CO RCR KO

Price list

Bound armchair

Upholstered seat shell with profile, upholstered seat cushion.
Base - Ø 60 mm swivel column with memory function and bottom base plate,
made of powder-coated steel, no glides.



BOUND ARMCHAIR SWIVEL CO KO

W 775 mm
D 635 mm
H 756 mm
SH 431 mm
SH DIN 400 mm
WT 36,5 kg

Basic price (EUR) according to upholstery price group

| | |
|---|------|
| 2 | 1234 |
| 3 | 1276 |
| 4 | 1295 |

| | | | | | |
|--------------------------------------|--|-----------------------------------|---|----------|---|
| Seat shell finish | Seat shell: Upholstery | Seat shell profile: Upholstery | The upholstery type is the same for each upholstered element, colours may vary | BSA-⑤/⑥ | • |
| Seat cushion | Upholstered in seat shell colour | | | SE-⑤ | • |
| Base finish | Powder-coated steel | | | BC-③ | • |
| Foam | Flame-retardant foam | | | FFR2 | • |
| Wood and wood-based materials | Raw material – EU timber regulation, from certified forests, FSC certificate – authorized companies | | | FSC | • |
| Assembly | Assembled, cardboard packaging | | | PACK-ASM | • |

Sample order BOUND ARMCHAIR SWIVEL CO KO (BSA-CUR68181/CUR68181 SE-CUR68181 BC-BL FFR2 FSC PACK-ASM)

- ③ – Please specify metal colour code – [see finishes](#)
- ⑤ – Please specify upholstery colour code from selected price group – [see finishes](#)
- ⑥ – Please specify upholstery colour code from selected price group – [see finishes](#)

- Available as standard (included in basic price)

Price list

Bound sofa

Upholstered seat shell with profile, upholstered seat cushion.
Base - two Ø 60 mm columns and shaped bottom base plate,
made of powder-coated steel, no glides.



BOUND SOFA CO KO

W 1730
D 635 mm
H 760 mm
SH 435 mm
SH DIN 400 mm
WT 82 kg

Basic price (EUR) according to upholstery price group

| | |
|---|------|
| 2 | 2036 |
| 3 | 2111 |
| 4 | 2157 |

| | | | | | |
|--------------------------------------|--|-----------------------------------|---|-------------|---|
| Seat shell finish | Seat shell: Upholstery | Seat shell profile: Upholstery | The upholstery type is the same for each upholstered element, colours may vary | BSA-(5)/(6) | • |
| Seat cushion | Upholstered in seat shell colour | | | SE-(5) | • |
| Base finish | Powder-coated steel | | | BC-(3) | • |
| Foam | Flame-retardant foam | | | FFR2 | • |
| Wood and wood-based materials | Raw material – EU timber regulation, from certified forests, FSC certificate – authorized companies | | | FSC | • |
| Assembly | Assembled, cardboard packaging | | | PACK-ASM | • |

Sample order BOUND SOFA CO KO (BSA-CUR68186/CUR68186 SE-CUR68186 BC-BL FFR2 FSC PACK-ASM)

- ③ – Please specify metal colour code – [see finishes](#)
- ⑤ – Please specify upholstery colour code from selected price group – [see finishes](#)
- ⑥ – Please specify upholstery colour code from selected price group – [see finishes](#)

- Available as standard (included in basic price)

Bound table

Soft square table top, made of MDF board covered with Fenix NTM® Laminate.
Base - Ø 50 mm column and bottom base plate, made of powder-coated steel, no glides.



BOUND TABLE CO RCR KO

| | | WT (kg) | 26,2 | 26,6 |
|--------------------------------------|--|-------------------|------|------|
| Width (mm) | W700 | 700 | | |
| Depth (mm) | D700 | 700 | | |
| Height (mm) | H... | 452 | 552 | |
| | | Basic price (EUR) | | |
| | | 486 | 490 | |
| Table top finish | Fenix NTM® Edge: 1 mm – laser (in table top colour) | ① | • | |
| Base finish | Powder-coated steel | BC-③ | • | |
| Wood and wood-based materials | Raw material – EU timber regulation | EUTR | • | |
| Assembly | Unassembled, cardboard packaging | PACK-UA | • | |
| Sample order | BOUND TABLE CO RCR KO (W700 D700 H452 KJ BC-BL EUTR PACK-UA) | | | |

① – Please specify table top colour code – [see finishes](#)

③ – Please specify metal colour code – [see finishes](#)

• Available as standard (included in basic price)

Finishes

Metal



**NCS S
2005-Y60R**
Cashmere
NK



RAL 1024
Ochre Yellow
OY



**RAL 030
50 40**
Vermilion
Red
VR



RAL 6003
Olive Green
OG



RAL 5000
Violet Blue
VB



RAL 9016
Traffic White
WT



RAL 9005
Jet Black
BL

Fenix NTM®



KJ
Nero Ingo



KN
Grigio
Bromo



KM
Grigio
Antrim



KP
Rosso Jaipur



KR
Verde
Comodoro



KO
Blu Fes

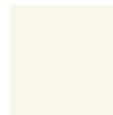

KS
Bianco Kos

General notes

All specified dimensions are approximate. Subject to minor modifications or differences for reasons of design improvements or for technical reasons.

- W = width
- D = depth
- H = height
- DI = diameter
- SH = seat height
- SH DIN = seat height measured acc. to DIN EN 1335 -1
- WT = weight

In compliance with the highest quality standards "Quality is irreplaceable." Guided by this principle, each product line is subjected to stringent quality testing.

Only the products marked in this document are FSC® (FSC®-C120977). Look for our FSC®-certified products. Sale of products that meet the FSC® requirements is possible only by Nowy Styl Sp. z o.o., Nowy Styl Nederland B.V. and Kusch + Co GmbH.



The FSC certificate applies to responsible forest management and the entire flow of raw materials from the forest to the customer. Each stage of the chain is monitored in terms of social, ecological and economic performance. The product with the FSC label gives customers a guarantee that the wood used for the production of the product comes from sources managed in a sustainable manner.

Warranty

Manufacturer declares that the products shall be free from defects in material or workmanship. The warranty is given to the original purchaser only, for normal commercial usage. Detailed terms of warranty and warranty periods are available at <https://www.kusch.com/en/warranty>

palato price list 2026

Palato

Design by team form ag

Armchair on 4 wooden legs



PALATO ARMCHAIR 4L



PALATO ARMCHAIR 4LA



PALATO ARMCHAIR 4LA HB

Sofa on 4 wooden legs



PALATO SOFA 4LA

Price list

Palato armchair on 4 wooden legs

Upholstered seat and backrest.
Frame on 4 legs made of solid beech wood, with or without armrests, plastic glides.



| | | | PALATO ARMCHAIR 4L | PALATO ARMCHAIR 4LA |
|-------------------------------|--|---------|---|---|
| | | | W 490 mm D 640 mm H 860 mm SH 450 mm SH DIN 445 mm WT 8 kg | W 560 mm D 640 mm H 860 mm SH 450 mm SH DIN 445 mm WT 8,5 kg |
| | | | Basic price (EUR) according to upholstery price group | |
| Price group 2 | | | 457 | 544 |
| Price group 3 | | | 479 | 562 |
| Price group 4 | | | 503 | 587 |
| Price group 5 | | | 520 | 607 |
| Price group 6 | | | 716 | 800 |
| Seat height | 450 mm | SH450 | • | • |
| | 500 mm | SH500 | 61 | 61 |
| Frame | Solid beech wood | natural | • | • |
| | | stained | E-① | 20 |
| Backrest | Upholstered | BA-⑤ | • | • |
| Seat | Upholstered | SE-⑤ | • | • |
| | Upholstered, removable | SE-R-⑤ | 12 | 12 |
| Glides | Plastic | GD | • | • |
| | Plastic with felt | GDF | 8 | 8 |
| | Protect glides | GDT | 9 | 9 |
| Foam | Standard foam | FSTD | • | • |
| | Flame retardant foam | FFR2 | 12 | 12 |
| | Flame retardant foam with fireproof fabric | FFRF | 115 | 115 |
| Wood and wood-based materials | Raw material - EU Timber regulation | EUTR | • | • |
| Wooden elements lacquering | Water lacquer UV | UV | • | • |
| | Water lacquer | | - 20 | - 20 |

Sample order PALATO ARMCHAIR 4L (SH450 E-SKNB BA-CPC23 SE-CPC23 GDF FSTD EUTR UV)

- ① – Please specify wood colour code – [see finishes](#)
 ⑤ – Please specify upholstery colour code from selected price group – [see finishes](#)
 • Available as standard (included in basic price)

PRICE GROUP 2: Boogie, Cura, Cura Loop, Home, Valencia, Xtreme
 PRICE GROUP 3: Chili, Moulin-Fr, Silvertex, Step/Step Melange
 PRICE GROUP 4: Blazer, Focus Royal, Main Line Flax, Oceanic, skai Parotega, Synergy
 PRICE GROUP 5: Remix 3
 PRICE GROUP 6: Nappa leather

Price list

Palato armchair/sofa on 4 wooden legs

Upholstered seat and backrest.
Frame on 4 legs made of solid beech wood, with or without armrests, plastic glides.



**PALATO ARMCHAIR
4LA HB**

W 560 mm
D 650 mm
H 1060 mm
SH 450 mm
SH DIN 445 mm
WT 9,5 kg

**PALATO SOFA
4LA**

W 1300 mm
D 670 mm
H 860 mm
SH 450 mm
SH DIN 445 mm
WT 19 kg

Basic price (EUR) according to upholstery price group

| | | | 584 | 1413 |
|--------------------------------------|--|---------|------|------|
| | Price group 2 | | | |
| | Price group 3 | | 609 | 1461 |
| | Price group 4 | | 642 | 1528 |
| | Price group 5 | | 665 | 1570 |
| | Price group 6 | | 900 | 2050 |
| Seat height | 450 mm | SH450 | • | • |
| | 500 mm | SH500 | 61 | — |
| Frame | Solid beech wood | natural | • | • |
| | | stained | E-① | 20 |
| Backrest | Upholstered | BA-⑤ | • | • |
| Seat | Upholstered | SE-⑤ | • | • |
| | Upholstered, removable | SE-R-⑤ | 12 | — |
| Glides | Plastic | GD | • | • |
| | Plastic with felt | GDF | 8 | 8 |
| | Protect glides | GDT | 9 | 9 |
| Foam | Standard foam | FSTD | • | • |
| | Flame retardant foam | FFR2 | 15 | 99 |
| | Flame retardant foam with fireproof fabric | FFRF | 136 | 391 |
| Wood and wood-based materials | Raw material - EU Timber regulation | EUTR | • | • |
| Wooden elements lacquering | Water lacquer UV | UV | • | • |
| | Water lacquer | | - 20 | - 26 |

Sample order PALATO ARMCHAIR 4LA HB (SH450 E-SKNB BA-CPC23 SE-CPC23 GDF FSTD EUTR UV)

① – Please specify wood colour code – [see finishes](#)

⑤ – Please specify upholstery colour code from selected price group – [see finishes](#)

- Available as standard (included in basic price)

Finishes

Wood

Natural



SKNB
Natural
Beech

Stained



2.07Y
Black



2.06S
Slate



S39
Light Grey

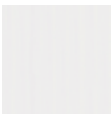

2.09S
White



2.0CB
Acacia



SK40
Oak



2.0CC
Walnut

General notes

All specified dimensions are approximate. Subject to minor modifications or differences for reasons of design improvements or for technical reasons.

- W = width
- D = depth
- H = height
- DI = diameter
- SH = seat height
- SH DIN = seat height measured acc. to DIN EN 1335-1

In compliance with the highest quality standards "Quality is irreplaceable." Guided by this principle, each product line is subjected to stringent quality testing.

Warranty

Manufacturer declares that the products shall be free from defects in material or workmanship. The warranty is given to the original purchaser only, for normal commercial usage. Detailed terms of warranty and warranty periods are available at <https://www.kusch.com/en/warranty>

Baricosi price list 2026

Baricosi

Design: Kusch+Co Designteam

Armchair on 4 metal legs



BARICOSI ARMCHAIR 4LA

Price list

Baricosi armchair on 4 metal legs

Upholstered shell.
Frame with integrated armrests, plastic armpads.
Powder-coated frame, plastic glides.



BARICOSI ARMCHAIR 4LA

W 880 mm
D 800 mm
WT 26 kg

Basic price (EUR)
according to upholstery price group

| | | | |
|--------------------------------------|---|-------|------|
| | Price group 2 | | 1630 |
| | Price group 3 | | 1660 |
| | Price group 4 | | 1675 |
| | Price group 5 | | 1710 |
| | Price group 6 | | 1865 |
| Seat height | 450 mm (overall height 980 mm) | SH450 | • |
| | 500 mm (overall height 1030 mm) | SH500 | 45 |
| Frame | Steel powder-coated | E-③ | • |
| Seat shell | Upholstery | BS-⑤ | • |
| Armpads | Black plastic | AP-KB | • |
| Glides | Plastic | GD | • |
| Foam | Flame retardant | FFR2 | • |
| | Flame retardant with fireproof fabric | FFRF | 111 |
| Wood and wood-based materials | Raw material from certified forests, FSC certificate – authorized companies | FSC | • |
| Assembly | Assembled | ASM-F | • |
| Sample order | BARICOSI ARMCHAIR 4LA (SH450 E-WK BS-CUR61259 AP-KB GD FFR2 FSC ASM-F) | | |

③ – Please specify metal colour code – [see finishes](#)

⑤ – Please specify upholstery colour code from selected price group – [see finishes](#)

• Available as standard (included in basic price)

PRICE GROUP 2: Cura, Cura Loop, Valencia, Xtreme
PRICE GROUP 3: Silvertex, Step/Step Melange
PRICE GROUP 4: Blazer, Main Line Flax, skai Parotega, Synergy
PRICE GROUP 5: Remix 3
PRICE GROUP 6: Nappa leather

Finishes

Metal



RAL 9005
Jet Black
BK



DB 703
Iron Mica
IM



Silver 98
SV



Silver Aluminium
SA



RAL 9006
White Aluminium
WK



Silk
KSK



RAL 9003
Signal White
WS

General notes

All specified dimensions are approximate. Subject to minor modifications or differences for reasons of design improvements or for technical reasons.

- W = width
- D = depth
- H = height
- DI = diameter
- SH = seat height
- SH DIN = seat height measured acc. to DIN EN 1335-1

In compliance with the highest quality standards "Quality is irreplaceable." Guided by this principle, each product line is subjected to stringent quality testing.

Only the products marked in this document are FSC® (FSC®-C120977) certified. Look for our FSC®-certified products. Sale of products that meet the FSC® requirements is possible only by Nowy Styl Sp. z o.o., Nowy Styl Nederland B.V. and Kusch + Co GmbH.



The mark of responsible forestry

The FSC® certificate applies to responsible forest management and the entire flow of raw materials from the forest to the customer. Each stage of the chain is monitored in terms of social, ecological and economic performance. The product with the FSC® label gives customers a guarantee that the wood used for the production of the product comes from sources managed in a sustainable manner.

Warranty

Manufacturer declares that the products shall be free from defects in material or workmanship. The warranty is given to the original purchaser only, for normal commercial usage. Detailed terms of warranty and warranty periods are available at <https://www.kusch.com/en/warranty>.

Kusch+Co GmbH
P.O. Box 1151
59965 Hallenberg
Germany

T +49 2984 300-0
welcome@kusch.com
kusch.com

vega price list 2026

Vega

Design by Dieter Kusch

Armchair on wooden frame



VEGA ARMCHAIR 4LA



VEGA ARMCHAIR 4LA HB

Sofa on wooden frame



VEGA SOFA 4LA

Armchair/Sofa on sled metal frame



VEGA ARMCHAIR SLA

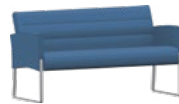

VEGA SOFA SLA

Price list

Vega armchair on wooden frame

Upholstered seat and backrest.
Frame made of solid beech wood, with armrests, plastic glides.



| VEGA ARMCHAIR 4LA | VEGA ARMCHAIR 4LA HB |
|--|---|
| W 510 mm D 560 mm H 820 mm SH 450 mm SH DIN 420 mm WT 17,5 kg | W 650 mm D 800 mm H 1140 mm SH 450 mm SH DIN 430 mm WT 19,5 kg |

Basic price (EUR) according to upholstery price group

| | | | | |
|--------------------------------------|--|---------|------|------|
| | Price group 2 | | 920 | 1058 |
| | Price group 3 | | 955 | 1100 |
| | Price group 4 | | 999 | 1157 |
| | Price group 5 | | 1029 | 1198 |
| | Price group 6 | | 1322 | 1505 |
| Seat height | 450 mm | SH450 | • | • |
| | 500 mm | SH500 | 61 | 61 |
| Frame | Solid beech wood | natural | • | • |
| | | stained | E-① | 20 |
| Backrest | Upholstered | BA-⑤ | • | • |
| Seat | Upholstered | SE-⑤ | • | • |
| Glides | Plastic | GD | • | • |
| | Plastic with felt | GDF | 8 | 8 |
| | Protect glides | GDT | 9 | 9 |
| Foam | Standard foam | FSTD | • | • |
| | Flame retardant foam | FFR2 | 21 | 28 |
| | Flame retardant foam with fireproof fabric | FFRF | 261 | 317 |
| Wood and wood-based materials | Raw material - EU Timber regulation | EUTR | • | • |
| Wooden elements lacquering | Water lacquer UV | UV | • | • |
| | Water lacquer | | - 20 | - 20 |

Sample order VEGA ARMCHAIR 4LA (SH450 E-SKNB BA-CPC10 SE-CPC10 GD FSTD EUTR UV)

① – Please specify wood colour code – [see finishes](#)

⑤ – Please specify upholstery colour code from selected price group – [see finishes](#)

• Available as standard (included in basic price)

PRICE GROUP 2: Boogie, Cura, Cura Loop, Home, Valencia, Xtreme
PRICE GROUP 3: Chili, Moulin-Fr, Silvertex, Step/Step Melange
PRICE GROUP 4: Blazer, Focus Royal, Main Line Flax, skai Parotega, Synergy
PRICE GROUP 5: Remix 3
PRICE GROUP 6: Nappa leather

Price list

Vega sofa on wooden frame

Upholstered seat and backrest.
Frame made of solid beech wood, with armrests, plastic glides.



VEGA SOFA 4LA

W 1520 mm
D 690 mm
H 830 mm
SH 450 mm
SH DIN 430 mm
WT 34 kg

Basic price (EUR) according to upholstery price group

| | | | |
|--------------------------------------|--|---------|------|
| | Price group 2 | | 1629 |
| | Price group 3 | | 1709 |
| | Price group 4 | | 1816 |
| | Price group 5 | | 1894 |
| | Price group 6 | | 2388 |
| Seat height | 450 mm | SH450 | • |
| | 500 mm | SH500 | 61 |
| Frame | Solid beech wood | natural | E-① |
| | | stained | 20 |
| Backrest | Upholstered | BA-⑤ | • |
| Seat | Upholstered | SE-⑤ | • |
| | Plastic | GD | • |
| Glides | Plastic with felt | GDF | 8 |
| | Protect glides | GDT | 9 |
| | Standard foam | FSTD | • |
| Foam | Flame retardant foam | FFR2 | 47 |
| | Flame retardant foam with fireproof fabric | FFRF | 576 |
| Wood and wood-based materials | Raw material - EU Timber regulation | EUTR | • |
| Wooden elements lacquering | Water lacquer UV | UV | • |
| | Water lacquer | | - 20 |

Sample order VEGA SOFA 4LA (SH450 BA-CPC10 SE-CPC10 GD FSTD EUTR UV)

① - Please specify wood colour code - [see finishes](#)

⑤ - Please specify upholstery colour code from selected price group - [see finishes](#)

• Available as standard (included in basic price)

PRICE GROUP 2: Boogie, Cura, Cura Loop, Home, Valencia, Xtreme
PRICE GROUP 3: Chili, Moulin-Fr, Silvertex, Step/Step Melange
PRICE GROUP 4: Blazer, Focus Royal, Main Line Flax, skai Parotega, Synergy
PRICE GROUP 5: Remix 3
PRICE GROUP 6: Nappa leather

Vega armchair/sofa on sled metal frame

Upholstered seat and backrest.
Frame made of chromium plated steel, upholstered side parts and armrests.



| VEGA ARMCHAIR SLA | VEGA SOFA SLA |
|--|---|
| W 650 mm D 690 mm H 800 mm SH 450 mm SH DIN 430 mm WT 26 kg | W 1520 mm D 690 mm H 800 mm SH 450 mm SH DIN 430 mm WT 44 kg |

| | | | | Basic price (EUR) according to upholstery price group | |
|--------------------------------------|--|-----------------|-------------------|---|------|
| | Price group 2 | | | 1467 | 2150 |
| | Price group 3 | | | 1533 | 2267 |
| | Price group 4 | | | 1624 | 2419 |
| | Price group 5 | | | 1685 | 2529 |
| | Price group 6 | | | 2212 | 3294 |
| Frame | Steel | chromium plated | E- ^① | • | • |
| Backrest | Upholstered | | BA- ^⑤ | • | • |
| Seat | Upholstered | | SE- ^⑤ | • | • |
| Armrests | Upholstered | | ARF- ^⑤ | • | • |
| Glides | None | | | • | • |
| | Plastic with felt | | GDF | 8 | 8 |
| Foam | Standard foam | | FSTD | • | • |
| | Flame retardant foam | | FFR2 | 24 | 47 |
| | Flame retardant foam with fireproof fabric | | FFRF | 264 | 576 |
| Wood and wood-based materials | Raw material - EU Timber regulation | | EUTR | • | • |
| Sample order | VEGA ARMCHAIR SLA (E-CR BA-CPC10 SE-CPC10 ARF-CPC10 FSTD EUTR) | | | | |

^① – Please specify wood colour code – [see finishes](#)

^⑤ – Please specify upholstery colour code from selected price group – [see finishes](#)

- Available as standard (included in basic price)

PRICE GROUP 2: Boogie, Cura, Cura Loop, Home, Valencia, Xtreme
PRICE GROUP 3: Chili, Moulin-Fr, Silvertex, Step/Step Melange
PRICE GROUP 4: Blazer, Focus Royal, Main Line Flax, skai Parotega, Synergy
PRICE GROUP 5: Remix 3
PRICE GROUP 6: Nappa leather

Finishes

Wood

Natural



SKNB
Natural
Beech

Stained



2.07Y
Black



2.06S
Slate



S39
Light Grey

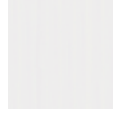

2.09S
White



2.0CB
Acacia



SK40
Oak



2.0CC
Walnut

Metal



Chrome
CR

General notes

All specified dimensions are approximate. Subject to minor modifications or differences for reasons of design improvements or for technical reasons.

- W = width
- D = depth
- H = height
- DI = diameter
- SH = seat height
- SH DIN = seat height measured acc. to DIN EN 1335-1

In compliance with the highest quality standards "Quality is irreplaceable." Guided by this principle, each product line is subjected to stringent quality testing.

Warranty

Manufacturer declares that the products shall be free from defects in material or workmanship. The warranty is given to the original purchaser only, for normal commercial usage. Detailed terms of warranty and warranty periods are available at <https://www.kusch.com/en/warranty>

são paulo price list 2026

São paulo

Design by Norbert Geelen

Office swivel chair



SAO PAULO SWIVEL CHAIR
MESH



SAO PAULO SWIVEL CHAIR
UPH LIGHT

Price list

Office swivel chair

Base and backrest support made of black plastic, parts made of black plastic, synchronous mechanism with seat depth and seat inclination adjustment, pneumatic gas lift with comfort gas action with permanent depth cushioning, upholstered seat with upholstered side drops in the same upholstery type and colour, standard foam, upholstered or mesh (Harlequin™ 3D Net Textile) backrest, castors for soft floors.



| SAO PAULO SWIVEL CHAIR MESH | SAO PAULO SWIVEL CHAIR UPH LIGHT |
|---|---|
| replaces versions: • 6002/1 • 6002/3 • 6012/3 | replaces versions: • 6005/1 • 6005/3 • 6015/3 |
| W 730 mm D 730 – 900 mm H 1030 – 1150 mm SH DIN 410 – 530 mm WT 19,0 kg | W 730 mm D 730 – 900 mm H 1030 – 1150 mm SH DIN 410 – 530 mm WT 20,5 kg |

Basic price (EUR)
according to upholstery price group

| | | | | | | | |
|-----------------------|---|--|-------------------------|----------------------|--------------|-----|-----|
| | Price group 2 | | | | 690 | 767 | |
| | Price group 3 | | | | 697 | 784 | |
| | Price group 4 | | | | 709 | 802 | |
| | Price group 5 | | | | 719 | 818 | |
| | Price group 6 | | | | 810 | 994 | |
| Mechanism | Synchronous mechanism with seat depth adjustment and negative seat inclination | | | SYN2-ST | • | • | |
| | No headrest | | | | • | • | |
| Headrest | Headrest with height and depth adjustment | Harlequin 3D fabric | | HR-⑤ | 131 | — | |
| | | Harlequin 3D fabric, black | Fabric upholstered pad | | HR-HQ60999/⑤ | 161 | 161 |
| | | | Leather upholstered pad | | | 189 | 189 |
| Lumbar support | No lumbar support | | | | • | • | |
| | Manual, with height and depth adjustment | | | LU4 | 38 | 38 | |
| Backrest | Harlequin 3D fabric | | | BA-⑤ | • | — | |
| | Harlequin 3D fabric, black | Upholstered pad | | BA-HQ60999/⑤ | — | • | |
| Seat | Upholstered | | | SE-⑤ | • | • | |
| | None | | | | • | • | |
| Armrests | Type: 2D | Bar: Black plastic | Pad: | Black PU | R80-B/BPU | 100 | 100 |
| | Type: 3D | | | Black PU | R81-B/BPU | 134 | 134 |
| | Type: Fixed | Ring armrests: polished aluminium with chrome effect | Pad: | Black PU | ARF-POL/BPU | — | 173 |
| | | | | Nappa leather, black | ARF-POL/LE | — | 298 |
| Gas lift | Seat height adjustment in range of 410 – 530 mm | | | GL-STD | • | • | |
| Base | Ø 735 mm five-star | Black polyamide | | TS70 | • | • | |
| | | Polished aluminium with chrome effect | | ST70-POL | 72 | 72 | |
| Castors | Ø 60 mm | For soft floors | | CA | • | • | |
| | | For hard floors | | CAH | ○ | ○ | |
| Foam | Standard foam | | | FSTD | • | • | |
| | Flame retardant foam | | | FFR2 | 11 | 15 | |
| Sample order | SAO PAULO SWIVEL CHAIR MESH (SYN2-ST BA-HQ60999 SE-CPC12 GL-STD ST70-POL CA FSTD) | | | | | | |

⑤ – Please specify upholstery colour code from selected price group – see finishes

- Available as standard (included in basic price)
- Available as an option (included in basic price)

PRICE GROUP 2: Cura, Cura Loop, Valencia, Xtreme
PRICE GROUP 3: Silvertex, Step/Step Melange
PRICE GROUP 4: Blazer, Main Line Flax, skai Parotega, Synergy

PRICE GROUP 5: Remix 3
PRICE GROUP 6: Nappa leather

Finishes

Metal



Chrome
CR



**Polished
Aluminium**
POL

General notes

All specified dimensions are approximate. Subject to minor modifications or differences for reasons of design improvements or for technical reasons.

- W = width
- D = depth
- H = height
- DI = diameter
- SH = seat height
- SH DIN = seat height measured acc. to DIN EN 1335-1

In compliance with the highest quality standards "Quality is irreplaceable." Guided by this principle, each product line is subjected to stringent quality testing.

Warranty

Manufacturer declares that the products shall be free from defects in material or workmanship. The warranty is given to the original purchaser only, for normal commercial usage. Detailed terms of warranty and warranty periods are available at <https://www.kusch.com/en/warranty>

creva stools price list 2026

Creva stool

Design by kaschkasch

Stool on 4 wooden legs



CREVA STOOL
4L LGW W



CREVA STOOL
4L H LGW W

Bench on 4 wooden legs



CREVA BENCH 4L
LGW UPH

Stool on 4 metal legs



CREVA STOOL
4L UPH



CREVA STOOL
4L H UPH

Price list

Creva stool on 4 wooden legs

Legs with integrated seat made of solid beech wood.
Footrest of high stool made of steel tube, powder-coated or chromium plated. Plastic glides.



| | | | CREVA STOOL 4L LGW W | CREVA STOOL 4L H LGW W |
|--------------------------------------|---|-------------------|---|---|
| | | | W 325 mm D 325 mm SH 460 mm SH DIN 450 mm WT 2,5 kg | W 365 mm D 325 mm SH 810 mm SH DIN 800 mm WT 6 kg |
| | | Basic price (EUR) | | |
| | | | 193 | 295 |
| Frame and seat | Solid beech wood | natural | • | • |
| | | stained | 19 | 19 |
| Footrest | Steel | powder-coated | - | • |
| | | chromium plated | | 10 |
| Glides | Plastic | | • | • |
| | | Plastic with felt | 8 | 8 |
| | | Protect glides | 9 | 9 |
| Wood and wood-based materials | Raw material – EU timber regulation, from certified forests, FSC certificate – authorized companies | FSC | • | • |
| Wooden elements lacquering | Water lacquer UV | UV | • | • |
| | Water lacquer | | -20 | -20 |
| Assembly | Assembled | ASM-F | • | • |

Sample order CREVA STOOL 4L LGW W (E-SKNB GD FSC UV ASM-F)

① – Please specify wood colour code – [see finishes](#)

③ – Please specify metal colour code – [see finishes](#)

- Available as standard (included in basic price)

Price list

Creva bench on 4 wooden legs

Upholstered seat.
 Frame made of solid beech wood.
 Metal leg mountings powder-coated in White aluminium (RAL 9006) colour.
 Plastic glides.



CREVA BENCH 4L LGW UPH

W 1200 mm
 D 360 mm
 SH 450 mm
 SH DIN 435 mm
 WT 14,5 kg

Basic price (EUR) according to upholstery price group

| | | | | |
|--------------------------------------|---|---------|------------------|-----|
| | Price group 2 | | | 525 |
| | Price group 3 | | | 541 |
| | Price group 4 | | | 555 |
| | Price group 5 | | | 615 |
| | Price group 6 | | | 654 |
| Frame | Solid beech wood | natural | E- ^① | • |
| | | stained | | 19 |
| Seat | Upholstered | | SE- ^⑤ | • |
| Glides | Plastic | | GD | • |
| | Plastic with felt | | GDF | 8 |
| Foam | Standard foam | | FSTD | • |
| | Flame retardant foam | | FFR2 | 10 |
| | Flame retardant foam with fireproof fabric | | FFRF | 59 |
| Wood and wood-based materials | Raw material from certified forests, FSC certificate – authorized companies | | FSCMIX | • |
| Wooden elements lacquering | Water lacquer UV | | UV | • |
| | Water lacquer | | | -20 |
| Assembly | Assembled | | ASM-F | • |

Sample order CREVA BENCH 4L LWM UPH (E-SKNB SE-VL4043 GD FSTD FSCMIX UV ASM-F)

① – Please specify wood colour code – [see finishes](#)

⑤ – Please specify upholstery colour code from selected price group – [see finishes](#)

- Available as standard (included in basic price)

PRICE GROUP 2: Cura, Cura Loop, Valencia, Xtreme
 PRICE GROUP 3: Silvertex, Step/Step Melange
 PRICE GROUP 4: Blazer, Main Line Flax, skai Parotega, Synergy
 PRICE GROUP 5: Remix 3
 PRICE GROUP 6: Nappa leather

Creva stool on 4 metal legs

Upholstered seat.
 Frame made of powder-coated steel.
 Footrest of high stool made of powder-coated or chromium plated steel tube.
 powder-coated or chromed. Plastic glides.



| CREVA STOOL 4L UPH | CREVA STOOL 4L H UPH |
|---|---|
| W 330 mm D 330 mm SH 460 mm SH DIN 450 mm WT 3,5 kg | W 355 mm D 330 mm SH 810 mm SH DIN 800 mm WT 7,5 kg |

Basic price (EUR) according to upholstery price group

| | | | | |
|--------------------------------------|---|-------|-----|-----|
| | Price group 2 | | 228 | 324 |
| | Price group 3 | | 231 | 338 |
| | Price group 4 | | 235 | 340 |
| | Price group 5 | | 237 | 358 |
| | Price group 6 | | 277 | 415 |
| Frame | Steel powder-coated | E-③ | • | • |
| Footrest | Steel powder-coated in frame colour | FB-③ | - | • |
| | chromium plated | | | 10 |
| Seat | Upholstered | SE-⑤ | • | • |
| | Plastic | GD | • | • |
| Glides | Plastic with felt | GDF | 8 | 8 |
| | Protect glides | GDT | 9 | 9 |
| Foam | Standard foam | FSTD | • | • |
| | Flame retardant foam | FFR2 | 8 | 8 |
| | Flame retardant foam with fireproof fabric | FFRF | 31 | 31 |
| Wood and wood-based materials | Raw material – EU timber regulation, from certified forests, FSC certificate – authorized companies | FSC | • | • |
| Assembly | Assembled | ASM-F | • | • |
| Sample order | CREVA STOOL 4L UPH (E-WS SE-VL1048 GD FSTD FSC ASM-F) | | | |

③ – Please specify metal colour code – [see finishes](#)

⑤ – Please specify upholstery colour code from selected price group – [see finishes](#)

• Available as standard (included in basic price)

PRICE GROUP 2: Cura, Cura Loop, Valencia, Xtreme
 PRICE GROUP 3: Silvertex, Step/Step Melange
 PRICE GROUP 4: Blazer, Main Line Flax, skai Parotega, Synergy
 PRICE GROUP 5: Remix 3
 PRICE GROUP 6: Nappa leather

Finishes

Wood

Natural



SKNB
Natural
Beech

Stained



2.07Y
Black



2.06S
Slate



S39
Light Grey



2.09S
White



2.0CB
Acacia



SK40
Oak



2.0CC
Walnut

Metal



RAL 9003
Signal White
WS



RAL 9006
White
Aluminium
WK



Silver 98
SV



DB 703
Iron Mica
IM



RAL 9005
Jet Black
BK, BL

Metal

for footrest



Chrome
CR

General notes

All specified dimensions are approximate. Subject to minor modifications or differences for reasons of design improvements or for technical reasons.

- W = width
- D = depth
- H = height
- DI = diameter
- SH = seat height
- SH DIN = seat height measured acc. to DIN EN 1335-1

In compliance with the highest quality standards "Quality is irreplaceable." Guided by this principle, each product line is subjected to stringent quality testing.

Only the products marked in this document are FSC® (FSC®-C120977).

Look for our FSC®-certified products. Sale of products that meet the FSC® requirements is possible only by Nowy Styl Sp. z o.o., Nowy Styl Nederland B.V. and Kusch + Co GmbH.



The FSC® certificate applies to responsible forest management and the entire flow of raw materials from the forest to the customer. Each stage of the chain is monitored in terms of social, ecological and economic performance. The product with the FSC® label gives customers a guarantee that the wood used for the production of the product comes from sources managed in a sustainable manner.

Warranty

Manufacturer declares that the products shall be free from defects in material or workmanship. The warranty is given to the original purchaser only, for normal commercial usage.

Detailed terms of warranty and warranty periods are available at

<https://www.kusch.com/en/warranty>

sivu
price list
2026

Sivu swivel armchair



SIVU ARMCHAIR 4S

Price list

Sivu swivel armchair

Upholstered seat and backrest.
 Seat and backrest supporting frame made of chromium plated steel.
 Base – Ø 45 mm swivel column altogether with four-arm base,
 diameter 805 mm – made of polished aluminium.
 Plastic glides.



SIVU ARMCHAIR 4S

W 805 mm
 D 805 mm
 H 780 mm
 SH 460 mm
 WT 14,22 kg

Basic price (EUR)
 according to price group of upholsteries

| | | | | | |
|---|---|---|-----------------------|-----------|-----|
| | Price group 2 | | | | 845 |
| | Price group 3 | | | | 895 |
| | Price group 4 | | | | 930 |
| Backrest finish | Upholstery (upholstery type and colour is the same for seat and backrest) | | | BA-⑤ | • |
| Seat finish | Upholstery (upholstery type and colour is the same for seat and backrest) | | | SE-⑤ | • |
| Base | Column | Seat and backrest supporting frame | | | |
| | Ø 805 mm four-star | Polished aluminium | Chromium plated steel | BC-POL/CR | • |
| Powder-coated steel, Jet Black RAL 9005 | | Powder-coated steel, Jet Black RAL 9005 | BC-BL/BL | ○ | |
| Glides | Plastic | | GD | | |
| Foam | Flame retardant | | FFR2 | | • |
| Assembly | Assembled, cardboard packaging | | ASM-F | | • |
| Sample order | SIVU ARMCHAIR 4S (BA-B068 SE-B068 BC-POL/CR GD FFR2 PACK-ASM) | | | | |

⑤ – Please specify upholstery colour code from selected price group – [see finishes](#)

- Available as standard (included in basic price)

Finishes

Metal

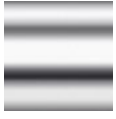

Chrome
CR

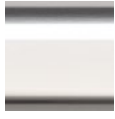

**Polished
Aluminium**
POL



RAL 9005
Jet Black
BL

General notes

All specified dimensions are approximate. Subject to minor modifications or differences for reasons of design improvements or for technical reasons.

- W = width
- D = depth
- H = height
- DI = diameter
- SH = seat height
- SH DIN = seat height measured acc. to DIN EN 1335-1

In compliance with the highest quality standards "Quality is irreplaceable." Guided by this principle, each product line is subjected to stringent quality testing.

Warranty

Manufacturer declares that the products shall be free from defects in material or workmanship. The warranty is given to the original purchaser only, for normal commercial usage. Detailed terms of warranty and warranty periods are available at <https://www.kusch.com/en/warranty>

terminal price list 2026

Terminal

Design by Prof. Jørgen Kastholm

Bench, metal shell



**TERMINAL BENCH
2U 4L M**



**TERMINAL BENCH
3U 4L M**



**TERMINAL BENCH
4U 4L M**

Bench, polyurethane (PU) shell



**TERMINAL BENCH
2U 4L P**



**TERMINAL BENCH
3U 4L P**



**TERMINAL BENCH
4U 4L P**

Price list

Terminal bench, metal shell



| TERMINAL BENCH 2U 4L M | TERMINAL BENCH 3U 4L M | TERMINAL BENCH 4U 4L M |
|--|--|--|
| W 1280 mm D 700 mm H 820 mm SH 440 mm SH DIN 380 mm 34 kg | W 1880 mm D 700 mm H 820 mm SH 440 mm SH DIN 380 mm 46 kg | W 2480 mm D 700 mm H 820 mm SH 440 mm SH DIN 380 mm 58 kg |
| Basic price (EUR) | | |
| 1308 | 1783 | 2255 |

| | Beam | Legs | | | | |
|--------------------|---------------------------------|-------------------------|----------|-----|-----|-----|
| Frame | Powder-coated | Powder-coated aluminium | E-③/③ | • | • | • |
| | | Polished aluminium | | 97 | 97 | 97 |
| Shell | Powder-coated perforated steel | | CC-③ | • | • | • |
| Raised seat | No raised seat | | | • | • | • |
| | Raised seat in position A | | SS-R-A | 71 | 71 | 71 |
| | Raised seat in position B | | SS-R-B | | — | — |
| | Raised seat in position C | | SS-R-C | | 71 | |
| | Raised seat in position D | | SS-R-D | | | |
| | Raised seat in position A and B | | SS-R-AB | — | — | 142 |
| | Raised seat in position C and D | | SS-R-CD | | | |
| Armrests | None | | | • | • | • |
| | External armrests | Powder-coated aluminium | ARM-EX-③ | 123 | 123 | 123 |
| | | Polished aluminium | | 219 | 219 | 219 |
| | Internal armrests | Powder-coated aluminium | ARM-IN-③ | 181 | 361 | 541 |
| | | Polished aluminium | | 229 | 457 | 685 |
| | Internal and external armrests | Powder-coated aluminium | ARM-EI-③ | 303 | 484 | 664 |
| Polished aluminium | | 448 | | 676 | 904 | |
| Wall spacer | None | | | • | • | • |
| | Wall spacer | | IN-WS | 42 | 42 | 42 |
| Glides | Plastic | | GD | • | • | • |
| | Plastic nonskid | | GDN | 9 | 9 | 9 |
| Assembly | Assembled | | ASM-F | • | • | • |
| | Unassembled | | ASM-U | ◦ | ◦ | ◦ |

Sample order TERMINAL BENCH 2U 4L M (E-WK/WK CC-WK GD ASM-F)

③ – Please specify metal colour code – [see finishes](#)

- Available as standard (included in basic price)
- Available as an option (included in basic price)

Price list

Terminal bench, polyurethane (PU) shell



| TERMINAL BENCH 2U 4L P | TERMINAL BENCH 3U 4L P | TERMINAL BENCH 4U 4L P |
|--|--|--|
| W 1280 mm D 670 mm H 850 mm SH 440 mm SH DIN 380 mm 36 kg | W 1880 mm D 670 mm H 850 mm SH 440 mm SH DIN 380 mm 49 kg | W 2480 mm D 670 mm H 850 mm SH 440 mm SH DIN 380 mm 62 kg |
| Basic price (EUR) | | |
| 1406 | 1881 | 2357 |

| | Beam | Legs | | | | |
|--------------------|---------------------------------|-------------------------|----------|-----|-----|-----|
| Frame | Powder-coated | Powder-coated aluminium | E-③/③ | • | • | • |
| | | Polished aluminium | | 97 | 97 | 97 |
| Shell | PU foam | | CC-④ | • | • | • |
| Raised seat | No raised seat | | | • | • | • |
| | Raised seat in position A | SS-R-A | 71 | 71 | 71 | 71 |
| | Raised seat in position B | SS-R-B | | | | |
| | Raised seat in position C | SS-R-C | — | 71 | — | — |
| | Raised seat in position D | SS-R-D | | | | |
| | Raised seat in position A and B | SS-R-AB | | | | |
| | Raised seat in position C and D | SS-R-CD | | | | |
| Armrests | None | | | • | • | • |
| | External armrests | Powder-coated aluminium | ARM-EX-③ | 123 | 123 | 123 |
| | | Polished aluminium | | 219 | 219 | 219 |
| | Internal armrests | Powder-coated aluminium | ARM-IN-③ | 112 | 223 | 334 |
| | | Polished aluminium | | 160 | 319 | 479 |
| | Internal and external armrests | Powder-coated aluminium | ARM-EI-③ | 234 | 346 | 457 |
| Polished aluminium | | 379 | | 538 | 698 | |
| Wall spacer | None | | | • | • | • |
| | Wall spacer | IN-WS | | 42 | 42 | 42 |
| Glides | Plastic | GD | | • | • | • |
| | Plastic nonskid | GDN | | 9 | 9 | 9 |
| Assembly | Assembled | ASM-F | | • | • | • |
| | Unassembled | ASM-U | | ◦ | ◦ | ◦ |

Sample order TERMINAL BENCH 2U 4L P (E-WK/WK CC-KB GD ASM-F)

③ – Please specify metal colour code – [see finishes](#)

④ – Please specify plastic colour code – [see finishes](#)

• Available as standard (included in basic price)

◦ Available as an option (included in basic price)

Terminal floor fixing



TERMINAL BENCH ACCESSORY FF

Basic price (EUR)

76

Finishes

Metal

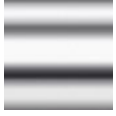

Chrome
CR

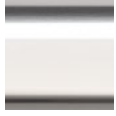

**Polished
Aluminium**
POL



RAL 9006
White
Aluminium
WK

General notes

All specified dimensions are approximate. Subject to minor modifications or differences for reasons of design improvements or for technical reasons.

- W = width
- D = depth
- H = height
- DI = diameter
- SH = seat height
- SH DIN = seat height measured acc. to DIN EN 1335-1

In compliance with the highest quality standards "Quality is irreplaceable." Guided by this principle, each product line is subjected to stringent quality testing.

Warranty

Manufacturer declares that the products shall be free from defects in material or workmanship. The warranty is given to the original purchaser only, for normal commercial usage. Detailed terms of warranty and warranty periods are available at <https://www.kusch.com/en/warranty>

creva
soft seating
price list
2026

Creva

Design: kaschkasch

Sofa



CREVA SOFA 1U

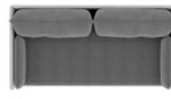

CREVA SOFA 2U

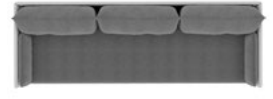

CREVA SOFA 3U



CREVA SOFA LS 2U

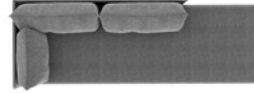

CREVA SOFA LS 3U

Mobile sofa



CREVA SOFA 1U MOB

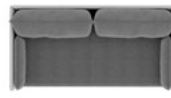

CREVA SOFA 2U MOB

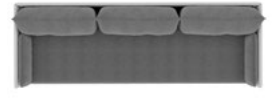

CREVA SOFA 3U MOB

Sofa Work / Sofa Work mobilne

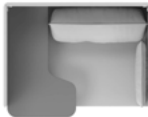

CREVA SOFA WORK 1U

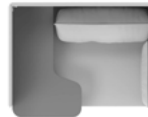

CREVA SOFA WORK 1U MOB

American Diner

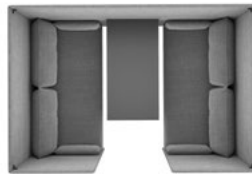

CREVA AMERICAN
DINER 4U

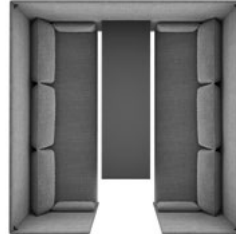

CREVA AMERICAN
DINER 6U

Creva

Design: kaschkasch

Landscape



CREVA LANDSCAPE
2/2 CUBE ZS DS



CREVA LANDSCAPE
2/2 CUBE SH DS



CREVA LANDSCAPE
2/T/2 LN OS



CREVA LANDSCAPE
2/T/1 LN OS



CREVA LANDSCAPE
1/TP/1 LN OS



CREVA LANDSCAPE
2/T/2 LN DS



CREVA LANDSCAPE
2/1 LN DS



CREVA LANDSCAPE
1/TP/TP/1 LN DS



CREVA LANDSCAPE
1/T/1 LN DS

Landscape



CREVA LANDSCAPE
2/TP/2 LS OS INT



CREVA LANDSCAPE
2/TP/2 LS OS EX

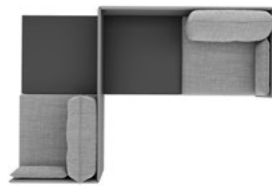

CREVA LANDSCAPE
1/TP/TP/1 LS DS



CREVA LANDSCAPE
2/3 LS OS INT

Pouffe, freestanding / for integration



CREVA
POUFFE 1U



CREVA
POUFFE 2U



CREVA
POUFFE 3U

Table, freestanding / for integration



CREVA TABLE UPH

Creva

Design: kaschkasch

Sample arrangements

Creva Landscape 1/TP/TP/1 linear double-sided

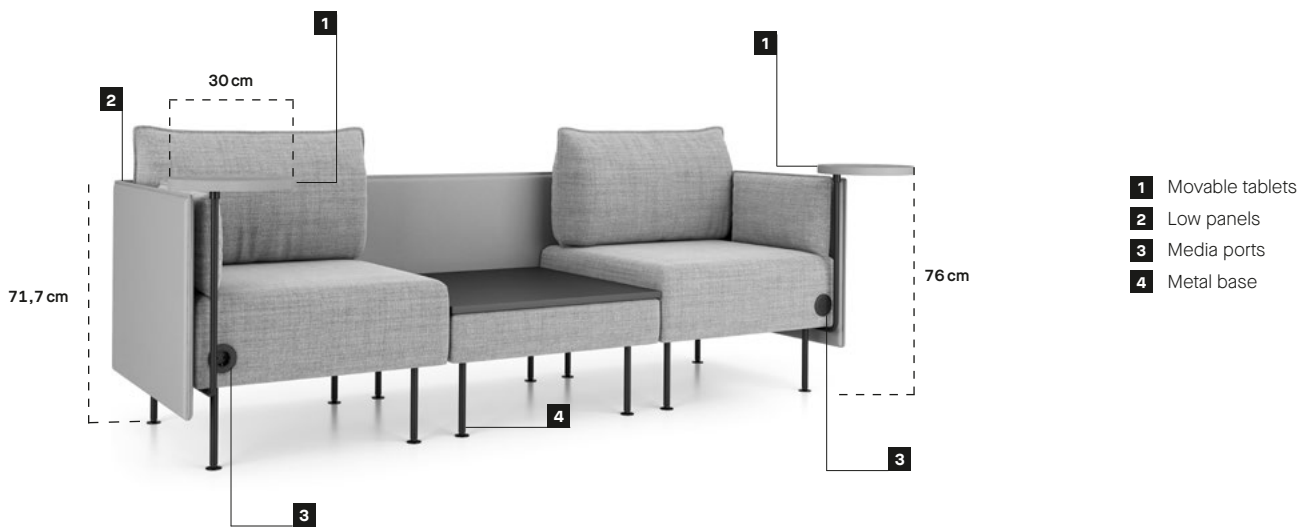

Sample arrangements of pouffes and tables

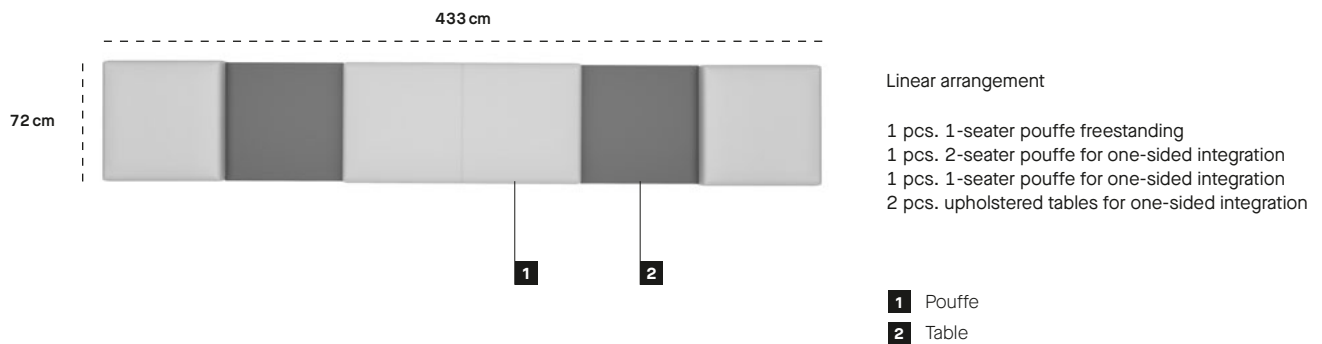
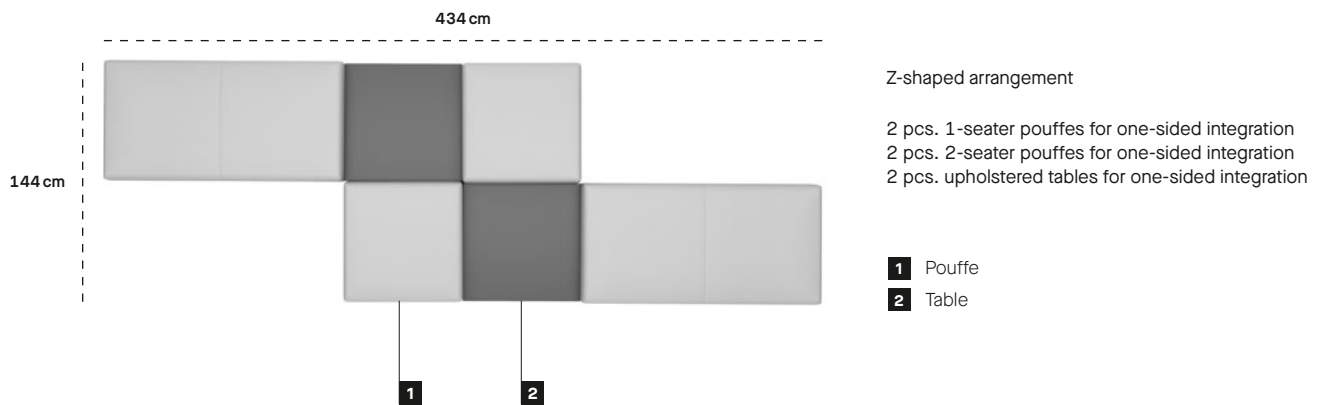
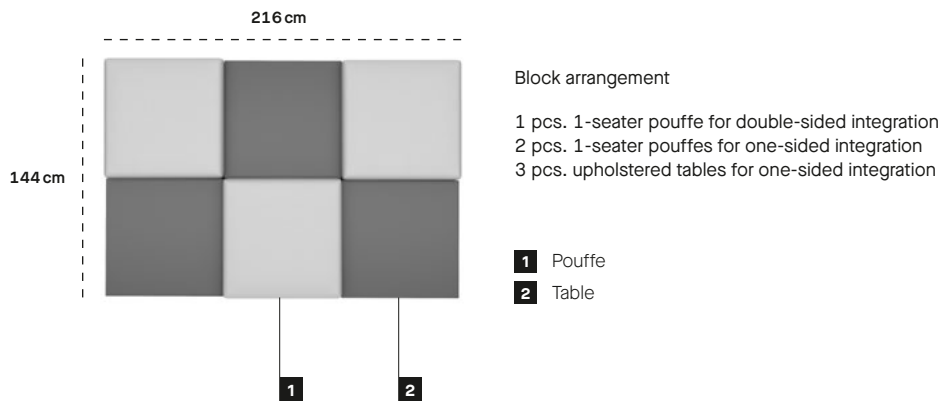

Price list

Creva sofa

Seat, low or high panels and cushions – upholstered, flame retardant foam.
Cushions connecting to panels with Velcro type fixing.
Base – powder-coated metal legs as standard or solid wood as an option, plastic glides in black colour.

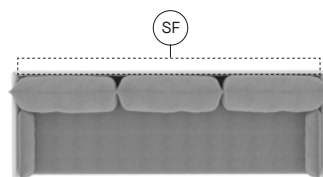

| CREVA SOFA 1U | CREVA SOFA 2U | CREVA SOFA 3U |
|---|--|---|
| W 776 mm D 763 mm H 873 / 1387 mm* SH 462 mm SH DIN 400 mm WT 37,8 / 60,3 kg** | W 1506 mm D 763 mm H 873 / 1387 mm* SH 462 mm SH DIN 400 mm WT 53,2 / 81,7 kg** | W 2236 mm D 763 mm H 873 / 1387 mm* SH 462 mm SH DIN 400 mm WT 69,0 / 104,0 kg** |

Basic price (EUR)
according to upholstery price group

| | | | |
|---------------|------|------|------|
| Price group 2 | 1120 | 1671 | 2254 |
| Price group 3 | 1181 | 1764 | 2380 |
| Price group 4 | 1266 | 1912 | 2573 |
| Price group 5 | 1305 | 1978 | 2685 |
| Price group 6 | 1696 | 2571 | 3491 |

Finish: seats, backrest cushions, side cushions

| | | | | |
|------------|-------|---|---|---|
| Upholstery | SBC-⑤ | • | • | • |
|------------|-------|---|---|---|

| | | | | | | |
|-------------------------|--------------|--------------------------|-------|--------------|------|-------|
| Low panels, upholstered | Price group: | 2 | P-L-⑤ | 436 | 524 | 647 |
| | | 3 | | 481 | 587 | 734 |
| | | 4 | | 544 | 661 | 837 |
| | | 5 | | 614 | 753 | 936 |
| | | 6 | | 798 | 979 | 1217 |
| | | High panels, upholstered | | Price group: | 2 | P-H-⑤ |
| 3 | 966 | | 1264 | | 1636 | |
| 4 | 1103 | | 1459 | | 1911 | |
| 5 | 1225 | | 1640 | | 2135 | |
| 6 | – | | – | | – | |

* – x/y cm - x: overall height with low panel / y: overall height with high panel

** – x/y cm - x: overall weight with low panel / y: overall height with high panel

⑤ – Please specify upholstery colour code from selected price group – [see finishes](#)

Ⓐ – Media ports positioning

Ⓢ – Working shelf positioning

• Available as standard (included in basic price)

To complete product configuration select options on next pages →

PRICE GROUP 2: Boogie, Cura, Cura Loop, Home, Valencia, Xtreme
PRICE GROUP 3: Chili, Moulin-Fr, Silvertex, Step/Step Melange
PRICE GROUP 4: Blazer, Focus Royal, Main Line Flax, skai Parotega, Synergy
PRICE GROUP 5: Remix 3
PRICE GROUP 6: Nappa leather

| | | | | CREVA SOFA 1U | CREVA SOFA 2U | CREVA SOFA 3U | |
|---|--|--------------------------------|--|------------------|---------------|---------------|-----|
| Working shelf (available for high panels only) | None | | | • | • | • | |
| | Melamine faced chipboard (MFC) | | | 112 | 142 | 171 | |
| | Laminate | | SF-① | 205 | 295 | 345 | |
| | Fenix NTM® | | | 245 | 344 | 602 | |
| Media (Sofa, location A) | None | | | • | • | • | |
| | A – 1 × PIP 1 × power socket 230V, cable length 3000 mm | | A-YKU1-⑧ | 140 | 140 | 140 | |
| | A – 1 × PIP 1 × double USB charger (type A + C), cable length 3000 mm | | A-YKU2-⑧ | 310 | 310 | 310 | |
| Base finish | Powder-coated steel | Jet black, RAL 9005 | BC-BK | • | • | • | |
| | Solid wood | Natural beech | | 95 | 95 | 95 | |
| | | Stained beech | | BC-① | 100 | 100 | 100 |
| | | Natural oak | | | 118 | 118 | 118 |
| Movable tablet (for solid wood base, table top in base colour) | None | | | • | • | • | |
| | Table top: Solid wood | Natural beech | Arm: Powder-coated steel, Jet black, RAL 9005 | MTF-①/BK – J1 | 153 | 153 | 153 |
| | | Stained beech | | | 156 | 156 | 156 |
| | | Natural oak | | | 163 | 163 | 163 |
| Foam | Flame retardant foam | | FFR2 | • | • | • | |
| Glides | Plastic glides | | GD | • | • | • | |
| | Nonskid glides | | GDN | 7 | 7 | 7 | |
| Wood and wood-based materials | Raw material – EU timber regulation, from certified forests, FSC certificate – authorized companies | (for model without a shelf) | FSC | • | • | • | |
| | Raw material – EU timber regulation | (for model with a shelf) | EUTR | | | | |
| Assembly | Assembled (seat with assembled base and panels) | | PACK-ASM | • | • | • | |
| | Unassembled (seat with assembled base) | | PACK-UA | ○ | ○ | ○ | |
| Sample order | CREVA SOFA 1U (SBC-CUZ63 P-H-LDS17 BC-BK FFR2 GD PACK-ASM) | | | | | | |
| | CREVA SOFA 1U (SBC-CUZ63 P-H-LDS17 SF-KM A-YKU1-FR BC-BK MTF-SKNB/BK FFR2 GD FSC PACK-ASM) | | | | | | |

① – Please specify wood colour code – see finishes

⑧ – Please specify media port standard: CH13, FR, GB, GE

• Available as standard (included in basic price)

○ Available as an option (included in basic price)

Price list

Creva 2-seater sofa with L-shape panels

Seat, low panels and cushions – upholstered, flame retardant foam.
Cushions connecting to panels with Velcro type fixing.
Base – powder-coated metal legs as standard or solid wood as an option, plastic glides in black colour.

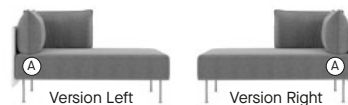

CREVA SOFA LS 2U

W 1478 mm
D 763 mm
H 873 mm
SH 462 mm
SH DIN 400 mm
WT 39,5 kg

Basic price (EUR)
according to upholstery price group

| | | | | |
|--|---|----------------------|-------------------|------|
| | Price group 2 | | | 1503 |
| | Price group 3 | | | 1587 |
| | Price group 4 | | | 1720 |
| | Price group 5 | | | 1781 |
| | Price group 6 | | | 2314 |
| Version | Left | V-L | | • |
| | Right | V-R | | ○ |
| Finish: seat, backrest cushions | Upholstery | | SBC- ^⑤ | • |
| | | | | |
| Panels finish | Low panels, upholstered | Price group: | 2 | 275 |
| | | | 3 | 308 |
| | | | 4 | 347 |
| | | | 5 | 396 |
| | | | 6 | 514 |
| Media (Sofa, location A) | None | | | • |
| | A – 1 × PIP 1 × power socket, cable length 3000 mm | A-YKU1- ^⑧ | | 140 |
| | A – 1 × PIP 1 × double USB charger (type A + C), cable length 3000 mm | A-YKU2- ^⑧ | | 310 |

^⑤ – Please specify upholstery colour code from selected price group – see finishes

^⑧ – Please specify media port standard: CH13, FR, GB, GE

[Ⓐ] – Media ports positioning

• Available as standard (included in basic price)

○ Available as an option (included in basic price)

To complete product configuration select options on next pages →

PRICE GROUP 2: Boogie, Cura, Cura Loop, Home, Valencia, Xtreme
PRICE GROUP 3: Chili, Moulin-Fr, Silvertex, Step/Step Melange
PRICE GROUP 4: Blazer, Focus Royal, Main Line Flax, skai Parotega, Synergy
PRICE GROUP 5: Remix 3
PRICE GROUP 6: Nappa leather

| | | | | CREVA SOFA LS 2U |
|--------------------------------------|---|---------------------|----------|------------------|
| Base finish | Powder-coated steel | Jet black, RAL 9005 | BC-BK | • |
| | Solid wood | Natural beech | | 95 |
| | | Stained beech | BC-① | 100 |
| | | Natural oak | | 118 |
| Foam | Flame retardant foam | | FFR2 | • |
| Glides | Plastic glides | | GD | • |
| | Nonskid glides | | GDN | 7 |
| Wood and wood-based materials | Raw material – EU timber regulation, from certified forests, FSC certificate – authorized companies | | FSC | • |
| Assembly | Assembled, cardboard packaging (seat with assembled base and panels) | | PACK-ASM | • |
| | Unassembled, cardboard packaging (seat with assembled base) | | PACK-UA | ○ |
| Sample order | CREVA SOFA LS 2U (V-L SBC-CUZ63 P-L-LDS17 A-YKU1-FR BC-BK FFR2 GD FSC PACK-ASM) | | | |

- ① – Please specify wood colour code – [see finishes](#)
- Available as standard (included in basic price)
 - Available as an option (included in basic price)

Price list

Creva 3-seater sofa with L-shape panels

Seat, low panels and cushions – upholstered, flame retardant foam.
Cushions connecting to panels with Velcro type fixing.
Base – powder-coated metal legs as standard or solid wood as an option, plastic glides in black colour.



CREVA SOFA LS 3U

W 2208 mm
D 763 mm
H 873 mm
SH 462 mm
SH DIN 400 mm
WT 60,4 kg

Basic price (EUR)
according to upholstery price group

| | | | | | |
|--|---|--------------|----------------------|---|-------------------|
| | Price group 2 | | | | 2029 |
| | Price group 3 | | | | 2142 |
| | Price group 4 | | | | 2316 |
| | Price group 5 | | | | 2416 |
| | Price group 6 | | | | 3142 |
| Version | Left | | V-L | | • |
| | Right | | V-R | | ○ |
| Finish: seat, backrest cushions | Upholstery | | SBC- ^⑤ | | • |
| | | | | | |
| Panels finish | Low panels, upholstered | Price group: | | 2 | 408 |
| | | | | 3 | 462 |
| | | | | 4 | 528 |
| | | | | 5 | 591 |
| | | | | 6 | – |
| | | | | | P-L- ^⑤ |
| Media (Sofa, location A) | None | | | | • |
| | A – 1 × PIP 1 × power socket, cable length 3000 mm | | A-YKU1- ^⑧ | | 140 |
| | A – 1 × PIP 1 × double USB charger (type A + C), cable length 3000 mm | | A-YKU2- ^⑧ | | 310 |

^⑤ – Please specify upholstery colour code from selected price group – [see finishes](#)

^⑧ – Please specify media port standard: CH13, FR, GB, GE

[Ⓐ] – Media ports positioning

- Available as standard (included in basic price)
- Available as an option (included in basic price)

To complete product configuration select options on next pages →

PRICE GROUP 2: Boogie, Cura, Cura Loop, Home, Valencia, Xtreme
PRICE GROUP 3: Chili, Moulin-Fr, Silvertex, Step / Step Melange
PRICE GROUP 4: Blazer, Focus Royal, Main Line Flax, skai Parotega, Synergy
PRICE GROUP 5: Remix 3
PRICE GROUP 6: Nappa leather

| | | | | CREVA SOFA LS 3U |
|--------------------------------------|---|---------------------|----------|------------------|
| Base finish | Powder-coated steel | Jet black, RAL 9005 | BC-BK | • |
| | Solid wood | Natural beech | BC-① | 95 |
| | | Stained beech | | 100 |
| | | Natural oak | | 118 |
| Foam | Flame retardant foam | | FFR2 | • |
| Glides | Plastic glides | | GD | • |
| | Nonskid glides | | GDN | 7 |
| Wood and wood-based materials | Raw material – EU timber regulation, from certified forests, FSC certificate – authorized companies | | FSC | • |
| Assembly | Assembled, cardboard packaging (seat with assembled base and panels) | | PACK-ASM | • |
| | Unassembled, cardboard packaging (seat with assembled base) | | PACK-UA | ○ |
| Sample order | CREVA SOFA LS 3U (V-L SBC-CUZ63 P-L-LDS17 A-YKU1-FR BC-BK FFR2 GD FSC PACK-ASM) | | | |

- ① – Please specify wood colour code – [see finishes](#)
- Available as standard (included in basic price)
 - Available as an option (included in basic price)

Price list

Creva mobile sofa

Seat, low or high panels and cushions – upholstered, flame retardant foam.
Cushions fixed to panels with Velcro.
Base – powder-coated metal legs, Ø 75 mm 4 black castors, including 2 with brakes.

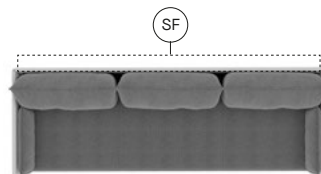

| CREVA SOFA 1U MOB | CREVA SOFA 2U MOB | CREVA SOFA 3U MOB |
|---|--|---|
| W 776 mm D 763 mm H 873 / 1387 mm* SH 462 mm SH DIN 400 mm WT 37,8 / 60,3 kg** | W 1506 mm D 763 mm H 873 / 1387 mm* SH 462 mm SH DIN 400 mm WT 53,2 / 81,7 kg** | W 2236 mm D 763 mm H 873 / 1387 mm* SH 462 mm SH DIN 400 mm WT 69,0 / 104,0 kg** |

Basic price (EUR) according to upholstery price group

| Price group | 1U MOB | 2U MOB | 3U MOB |
|---------------|--------|--------|--------|
| Price group 2 | 1220 | 1771 | 2354 |
| Price group 3 | 1281 | 1864 | 2480 |
| Price group 4 | 1366 | 2012 | 2673 |
| Price group 5 | 1405 | 2078 | 2785 |
| Price group 6 | 1796 | 2671 | 3591 |

| Finish: seats, backrest cushions, side cushions | | Upholstery | SBC- ^⑤ | • | • | • |
|---|--------------------------|--------------|-------------------|------|------|------|
| Panels finish | Low panels, upholstered | Price group: | 2 | 436 | 524 | 647 |
| | | | 3 | 481 | 587 | 734 |
| | | | 4 | 544 | 661 | 837 |
| | High panels, upholstered | Price group: | 5 | 614 | 753 | 936 |
| | | | 6 | 798 | 979 | 1217 |
| | | | 2 | 870 | 1111 | 1427 |
| Panels finish | High panels, upholstered | Price group: | 3 | 966 | 1264 | 1636 |
| | | | 4 | 1103 | 1459 | 1911 |
| | | | 5 | 1225 | 1640 | 2135 |
| | | | 6 | — | — | — |

* – x / y cm - x: overall height with low panel / y: overall height with high panel
** – x / y cm - x: overall weight with low panel / y: overall height with high panel

To complete product configuration select options on next pages →

^⑤ – Please specify upholstery colour code from selected price group – [see finishes](#)

^{SF} – Working shelf positioning

• Available as standard (included in basic price)

PRICE GROUP 2: Boogie, Cura, Cura Loop, Home, Valencia, Xtreme
PRICE GROUP 3: Chili, Moulin-Fr, Silvertex, Step / Step Melange
PRICE GROUP 4: Blazer, Focus Royal, Main Line Flax, skai Parotega, Synergy
PRICE GROUP 5: Remix 3
PRICE GROUP 6: Nappa leather

| | | | | CREVA SOFA 1U MOB | CREVA SOFA 2U MOB | CREVA SOFA 3U MOB | |
|---|--|--------------------------------|--|-------------------|-------------------|-------------------|-----|
| Working shelf (available for high panels only) | None | | | • | • | • | |
| | Melamine faced chipboard (MFC) | | | 112 | 142 | 171 | |
| | Laminate | | SF-① | 205 | 295 | 345 | |
| | Fenix NTM® | | | 245 | 344 | 602 | |
| Base finish | Powder-coated steel | Jet black, RAL 9005 | BC-BK | • | • | • | |
| Movable tablet | None | | | • | • | • | |
| | Solid wood | Natural beech | Arm: Powder- coated steel, Jet black, RAL 9005 | MTF-①/BK - J1 | 95 | 95 | 95 |
| | | Stained beech | | | 100 | 100 | 100 |
| | | Natural oak | | | 118 | 118 | 118 |
| Foam | Flame retardant foam | | FFR2 | • | • | • | |
| Castors | For soft floors | | CA | • | • | • | |
| | For hard floors | | CAH | ○ | ○ | ○ | |
| Wood and wood-based materials | Raw material – EU timber regulation, from certified forests, FSC certificate – authorized companies | (for model without a shelf) | FSC | • | • | • | |
| | Raw material – EU timber regulation | (for model with a shelf) | EUTR | | | | |
| Assembly | Assembled, cardboard packaging (seat with assembled base and panels) | | PACK-ASM | • | • | • | |
| | Unassembled, cardboard packaging (seat with assembled base) | | PACK-UA | ○ | ○ | ○ | |
| Sample order | CREVA SOFA 1U MOB (SBC-CUZ63 P-L LDS17 BC BK FFR2 CA FSC PACK-ASM) | | | | | | |
| | CREVA SOFA 2U MOB (SBC-CUZ63 P-H-LDS17 BC-BK MTF-SKNB/BK-J1 FFR2 CA FSC PACK-ASM) | | | | | | |

① – Please specify wood colour code – [see finishes](#)

- Available as standard (included in basic price)
- Available as an option (included in basic price)

Price list

Creva sofa Work

Seat, high panels and cushions – upholstered, flame retardant foam.
Cushions fixed to panels with Velcro.
Base – powder-coated metal legs as standard or made of solid wood as an option, black plastic glides. Tablet integrated with sofa.

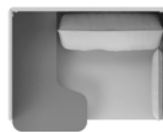

CREVA SOFA WORK 1U

W 1086 mm
D 840 mm
H 1387 mm
SH 462 mm
SH DIN 400 mm
WT 81,0 kg

Basic price (EUR)
according to upholstery price group

| | | | | |
|--|---|--------------|----------------------|------|
| | Price group 2 | | | 1670 |
| | Price group 3 | | | 1731 |
| | Price group 4 | | | 1816 |
| | Price group 5 | | | 1855 |
| | Price group 6 | | | 2246 |
| Finish: seats, backrest cushions, side cushions | Upholstery | | SBC- ^⑤ | • |
| | | 2 | | 870 |
| | | 3 | | 966 |
| Panels finish | High panels, upholstered | Price group: | 4 P-H- ^⑤ | 1103 |
| | | | 5 | 1225 |
| | | | 6 | – |
| | Melamine faced chipboard (MFC) | | | • |
| Table top finish | Laminate | | TF- ^① | 80 |
| | Fenix NTM® | | | 160 |
| | None | | | • |
| Media (sofas, location A) | A – 1 × PIP 1 × power socket, cable length 3000 mm | | A-YKU1- ^⑧ | 140 |
| | A – 1 × PIP 1 × double USB charger (type A + C), cable length 3000 mm | | A-YKU2- ^⑧ | 310 |

^① – Please specify colour code of table top – [see finishes](#)

To complete product configuration select options on next pages →

^⑤ – Please specify upholstery colour code from selected price group – [see finishes](#)

^⑧ – Please specify media port standard: CH13, FR, GB, GE

[Ⓐ] – Media ports positioning

• Available as standard (included in basic price)

PRICE GROUP 2: Boogie, Cura, Cura Loop, Home, Valencia, Xtreme
PRICE GROUP 3: Chili, Moulin-Fr, Silvertex, Step/Step Melange
PRICE GROUP 4: Blazer, Focus Royal, Main Line Flax, skai Parotega, Synergy
PRICE GROUP 5: Remix 3
PRICE GROUP 6: Nappa leather (not available for high panels)

| | | | | CREVA SOFA WORK 1U |
|--------------------------------------|---|---------------------|----------|--------------------|
| Base finish | Powder-coated steel | Jet black, RAL 9005 | BC-BK | • |
| | Solid wood | Natural beech | | 95 |
| | | Stained beech | BC-① | 100 |
| | | Natural oak | | 118 |
| Foam | Flame retardant foam | | FFR2 | • |
| Glides | Plastic glides | | GD | • |
| | Nonskid glides | | GDN | 7 |
| Wood and wood-based materials | Raw material – EU timber regulation | | EUTR | • |
| Assembly | Partially Assembled, cardboard packaging (seats with assembled base and panels) | | PACK-ASM | • |
| | Unassembled, cardboard packaging (seats with assembled base) | | PACK-UA | ○ |
| Sample order | CREVA SOFA WORK 1U (SBC-CUZ63 P-H-LDS17 TF-KM BC-BK FFR2 GD EUTR PACK-ASM) | | | |

① – Please specify wood colour code – [see finishes](#)

- Available as standard (included in basic price)
- Available as an option (included in basic price)

Price list

Creva mobile sofa Work

Seat, high panels and cushions – upholstered, flame retardant foam.
Cushions fixed to panels with Velcro.
Base – powder-coated metal legs, Ø 75 mm 4 black castors, including 2 with brakes.
Tablet integrated with sofa.

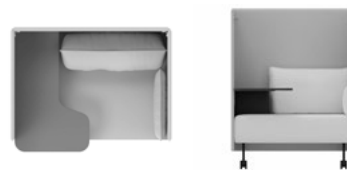

CREVA SOFA WORK 1U MOB

W 1086 mm
D 840 mm
H 1387 mm
SH 462 mm
SH DIN 400 mm
WT 81,0 kg

Basic price (EUR)
according to upholstery price group

| | | | | | |
|--|--------------------------------|--------------|-------|-------|------|
| | Price group 2 | | | | 1770 |
| | Price group 3 | | | | 1831 |
| | Price group 4 | | | | 1916 |
| | Price group 5 | | | | 1955 |
| | Price group 6 | | | | 2346 |
| Finish: seats, backrest cushions, side cushions | Upholstery | | SBC-⑤ | | • |
| | | | 2 | | 870 |
| | | | 3 | | 966 |
| Panels finish | High panels, upholstered | Price group: | 4 | P-H-⑤ | 1103 |
| | | | 5 | | 1225 |
| | | | 6 | | – |
| | Melamine faced chipboard (MFC) | | | | • |
| Table top finish | Laminate | | | TF-① | 80 |
| | Fenix NTM® | | | | 160 |

① – Please specify colour code of table top – [see finishes](#)

⑤ – Please specify upholstery colour code from selected price group – [see finishes](#)

• Available as standard (included in basic price)

To complete product configuration select options on next pages →

PRICE GROUP 2: Boogie, Cura, Cura Loop, Home, Valencia, Xtreme
PRICE GROUP 3: Chili, Moulin-Fr, Silvertex, Step/Step Melange
PRICE GROUP 4: Blazer, Focus Royal, Main Line Flax, skai Parotega, Synergy
PRICE GROUP 5: Remix 3
PRICE GROUP 6: Nappa leather (not available for high panels)

| | | | | CREVA SOFA WORK 1U MOB |
|--------------------------------------|---|---------------------|----------|------------------------|
| Base finish | Powder-coated steel | Jet black, RAL 9005 | BC-BK | • |
| Foam | Flame retardant foam | | FFR2 | • |
| Castors | For soft floors | | CA | • |
| | For hard floors | | CAH | ○ |
| Wood and wood-based materials | Raw material – EU timber regulation | | EUTR | • |
| Assembly | Partially Assembled, cardboard packaging (seats with assembled base and panels) | | PACK-ASM | • |
| | Unassembled, cardboard packaging (seats with assembled base) | | PACK-UA | ○ |
| Sample order | CREVA SOFA WORK 1U MOB (SBC-CUZ63 TF-KM BC-BK FFR2 CA EUTR PACK-ASM) | | | |

- Available as standard (included in basic price)
- Available as an option (included in basic price)

Price list

Creva American Diner 4-seater unit

Seats, high panels and cushions – upholstered, flame retardant foam.
 Cushions connecting to panels with Velcro type fixing.
 Base – powder-coated metal legs as standard or solid wood as an option, plastic glides in black colour.
 Table with rectangular table top, powder-coated metal base, as standard or made of solid wood as an option, plastic glides in black colour.

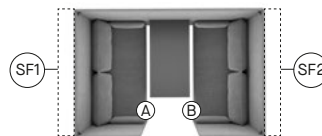

CREVA AMERICAN DINER 4U

| | |
|--|---|
| Arrangement: W 2236 mm D 1506 mm H 1387 mm SH 462 mm SH DIN 400 mm WT 187,3 kg | Table top: W 1070 mm D 550 mm H 720 mm |
|--|---|

Basic price (EUR)
according to upholstery price group

| | | | | | |
|--|--------------------------------|--------------|-------|-------|------|
| | Price group 2 | | | | 4130 |
| | Price group 3 | | | | 4314 |
| | Price group 4 | | | | 4612 |
| | Price group 5 | | | | 4746 |
| | Price group 6 | | | | 6169 |
| Finish: seats, backrest cushions, side cushions | Upholstery | | SBC-⑤ | | • |
| | | 2 | | | 2500 |
| | | 3 | | | 2843 |
| Panels finish | High panels, upholstered | Price group: | | P-H-⑤ | |
| | | 4 | | | 3281 |
| | | 5 | | | 3687 |
| | | 6 | | | – |
| | Melamine faced chipboard (MFC) | | | | • |
| Table top finish | Laminate | | TF-① | | 75 |
| | Fenix NTM® | | | | 142 |
| | None | | | | • |
| Working shelf SF1, (in table top finish) | Melamine faced chipboard (MFC) | | | | 142 |
| | Laminate | | SF1-① | | 295 |
| | Fenix NTM® | | | | 344 |

① – Please specify colour code of table top – [see finishes](#)

⑤ – Please specify upholstery colour code from selected price group – [see finishes](#)

Ⓐ – Media ports positioning

Ⓑ – Media ports positioning

Ⓢⓕ① – Working shelf positioning

Ⓢⓕ② – Working shelf positioning

• Available as standard (included in basic price)

To complete product configuration select options on next pages →

PRICE GROUP 2: Boogie, Cura, Cura Loop, Home, Valencia, Xtreme
 PRICE GROUP 3: Chili, Moulin-Fr, Silvertex, Step/Step Melange
 PRICE GROUP 4: Blazer, Focus Royal, Main Line Flax, skai Parotega, Synergy
 PRICE GROUP 5: Remix 3
 PRICE GROUP 6: Nappa leather (not available for high panels)

| | | | | CREVA AMERICAN DINER 4U | |
|---|--|---|------------|-------------------------|-----|
| Working shelf SF2, (in table top finish) | None | | | • | |
| | Melamine faced chipboard (MFC) | | | 142 | |
| | Laminate | SF2-① | | 295 | |
| | Fenix NTM® | | | 344 | |
| Media (sofas, location A/B) | None | | | • | |
| | A – 1 × PIP 1 × power socket, cable length 3000 mm B – 1 × PIP 1 × double USB charger (type A + C), cable length 3000 mm | A-YKU1/B-YKU2-⑧ | | 450 | |
| TV holder | None | | – | • | |
| | Fixed TV holder | Black | HO-TV | 66 | – |
| Media (table top) | None | | | • | ○ |
| | | 2 × Power socket 1 × double USB charger (typ A + C) Cable length 3000 mm | YD009-⑧-BL | 210 | 210 |
| | Power Frame 3M | 1 × power socket 1 × double USB charger (typ A + C) 1 × HDMI socket Cable length 3000 mm | YD060-⑧-BL | 300 | – |
| Base finish | Powder-coated steel | Jet black, RAL 9005 | BC-BK | | • |
| | Solid wood | Natural beech | | | 189 |
| | | Stained beech | BC-① | | 200 |
| | | Natural oak | | | 236 |
| Foam | Flame retardant foam | FFR2 | | • | |
| Glides | Plastic glides | GD | | • | |
| | Nonskid glides | GDN | | 17 | |
| Wood and wood-based materials | Raw material – EU timber regulation | EUTR | | • | |
| Assembly | Partially Assembled, cardboard packaging (seats with assembled base and panels) | PACK-A | | • | |
| | Unassembled, cardboard packaging (seats with assembled base) | PACK-UA | | ○ | |
| Sample order | CREVA AMERICAN DINER 4U (SBC-CUZ63 P-H-LDS17 TF-KM BC-BK FFR2 GD PACK-A) | | | | |
| | CREVA AMERICAN DINER 4U (SBC-CUZ63 P-H-LDS17 TF-KM SF1-KM SF2-KM A-YKU1/B-YKU2-FR YD009-FR-BL BC-BK FFR2 GD FSC EUTR PACK-A) | | | | |

① – Please specify wood colour code – see finishes

⑧ – Please specify media port standard: CH13, FR, GB, GE

• Available as standard (included in basic price)

○ Available as an option (included in basic price)

Price list

Creva American Diner 6-seater unit

Seats, high panels and cushions – upholstered, flame retardant foam.
 Cushions connecting to panels with Velcro type fixing.
 Base – powder-coated metal legs as standard or made of solid wood as an option, plastic glides in black colour.
 Table with rectangular table top, powder-coated metal base, plastic glides in black colour.

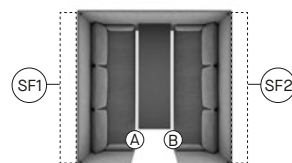

CREVA AMERICAN DINER 6U

| | |
|--|---|
| Arrangement: W 2236 mm D 2236 mm H 1387 mm SH 462 mm SH DIN 400 mm WT 240,6 kg | Table top: W 1800 mm D 550 mm H 720 mm |
|--|---|

Basic price (EUR)
according to upholstery price group

| | | | | | |
|--|--------------------------------|--------------|-------------------|-------------------|------|
| | Price group 2 | | | | 5453 |
| | Price group 3 | | | | 5705 |
| | Price group 4 | | | | 6092 |
| | Price group 5 | | | | 6318 |
| | Price group 6 | | | | 8213 |
| Finish: seats, backrest cushions, side cushions | Upholstery | | SBC- ^⑤ | | • |
| | | 2 | | | 3138 |
| | | 3 | | | 3600 |
| Panels finish | High panels, upholstered | Price group: | 4 | P-H- ^⑤ | 4204 |
| | | | 5 | | 4695 |
| | | | 6 | | – |
| | Melamine faced chipboard (MFC) | | | | • |
| Table top finish | Laminate | | TF- ^① | | 80 |
| | Fenix NTM® | | | | 150 |
| | None | | | | • |
| Working shelf SF1 (in table top finish) | Melamine faced chipboard (MFC) | | | | 171 |
| | Laminate | | SF1- ^① | | 345 |
| | Fenix NTM® | | | | 602 |

① – Please specify colour code of table top – see finishes

⑤ – Please specify upholstery colour code from selected price group – see finishes

Ⓐ – Media ports positioning

Ⓑ – Media ports positioning

ⓈF1 – Working shelf positioning

ⓈF2 – Working shelf positioning

• Available as standard (included in basic price)

To complete product configuration select options on next pages →

PRICE GROUP 2: Boogie, Cura, Cura Loop, Home, Valencia, Xtreme
 PRICE GROUP 3: Chili, Moulin-Fr, Silvertex, Step/Step Melange
 PRICE GROUP 4: Blazer, Focus Royal, Main Line Flax, skai Parotega, Synergy
 PRICE GROUP 5: Remix 3
 PRICE GROUP 6: Nappa leather (not available for high panels)

| | | | | CREVA AMERICAN DINER 6U | | |
|--|---|---|-----------------|-------------------------|-----|-----|
| | None | | | | • | |
| Working shelf SF2 (in table top finish) | Melamine faced chipboard (MFC) | | | | 171 | |
| | Laminate | | SF2-① | | 345 | |
| | Fenix NTM® | | | | 602 | |
| Media (sofas, location A/B) | None | | | | • | |
| | A – 1 × PIP 1 × power socket, cable length 3000 mm B – 1 × PIP 1 × double USB charger (type A + C), cable length 3000 mm | | A-YKU1/B-YKU2-⑧ | | 450 | |
| TV holder | None | | | – | • | |
| | Fixed TV holder | Black | HO-TV | 66 | – | |
| Media (table top) | None | | | • | ○ | |
| | | 2 × Power socket 1 × double USB charger (typ A + C) Cable length 3000 mm | | YD009-⑧-BL | 210 | 210 |
| | Power Frame 3M | 1 × power socket 1 × double USB charger (typ A + C) 1 × HDMI socket Cable length 3000 mm | | YD060-⑧-BL | 300 | – |
| Base finish | Powder-coated steel | Jet black, RAL 9005 | | BC-BK | • | |
| | Solid wood | Natural beech | | | 189 | |
| | | Stained beech | | BC-① | | 200 |
| | | Natural oak | | | | 236 |
| Foam | Flame retardant foam | | FFR2 | | • | |
| Glides | Plastic glides | | | GD | • | |
| | Nonskid glides | | | GDN | 17 | |
| Wood and wood-based materials | Raw material – EU timber regulation | | | EUTR | • | |
| Assembly | Partially Assembled, cardboard packaging (seats with assembled base and panels) | | | PACK-A | • | |
| | Unassembled, cardboard packaging (seats with assembled base) | | | PACK-UA | ○ | |
| Sample order | CREVA AMERICAN DINER 6U (SBC-CUZ63 P-H-LDS17 TF-KM BC-BK FFR2 GD PACK-A) | | | | | |
| | CREVA AMERICAN DINER 6U (SBC-CUZ63 P-H-LDS17 TF-KM SF1-KM SF2-KM A-YKU1/B-YKU2-FR YD009-FR-BL BC-BK FFR2 GD EUTR PACK-A) | | | | | |

① – Please specify wood colour code – see finishes

⑧ – Please specify media port standard: CH13, FR, GB, GE

• Available as standard (included in basic price)

○ Available as an option (included in basic price)

Price list

Creva Landscape 2/2 Cube Z double-sided

Seats, high panels and cushions – upholstered, flame retardant foam.
Cushions connecting to panels with Velcro type fixing.
Base – powder-coated metal legs as standard or made of solid wood as an option, plastic glides in black colour.

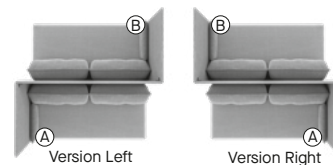

CREVA LANDSCAPE 2/2 CUBE ZS DS

W 1506 mm
D 1498 mm
H 1387 mm
SH 462 mm
SH DIN 400 mm
WT 57,6 kg

Basic price (EUR)
according to upholstery price group

| | | | | | |
|--|---|---------------------|-------|------|-----|
| | Price group 2 | | | 3173 | |
| | Price group 3 | | | 3348 | |
| | Price group 4 | | | 3630 | |
| | Price group 5 | | | 3758 | |
| | Price group 6 | | | 4884 | |
| Version | Left | V-L | | • | |
| | Right | V-R | | ○ | |
| Finish: seats, backrest cushions, side cushions | Upholstery | SBC-⑤ | | • | |
| | | | | | |
| Panels finish | High panels, upholstered | Price group: | 2 | 1111 | |
| | | | 3 | 1264 | |
| | | | 4 | 1459 | |
| | | | 5 | 1640 | |
| | | | 6 | — | |
| Media (sofas, location A/B) | None | | | • | |
| | A – 1 × PIP 1 × power socket, cable length 3000 mm B – 1 × PIP 1 × double USB charger (type A + C), cable length 3000 mm | A-YKU1/B-YKU2-⑧ | | 450 | |
| Base finish | Powder-coated steel | Jet black, RAL 9005 | BC-BK | • | |
| | | Natural beech | | 189 | |
| | Solid wood | Stained beech | BC-① | | 200 |
| | | Natural oak | | | 236 |

① – Please specify wood colour code – see finishes

⑤ – Please specify upholstery colour code from selected price group – see finishes

Ⓐ – Media ports positioning

Ⓑ – Media ports positioning

⑧ – Please specify media port standard: CH13, FR, GB, GE

• Available as standard (included in basic price)

○ Available as an option (included in basic price)

To complete product configuration select options on next pages →

PRICE GROUP 2: Boogie, Cura, Cura Loop, Home, Valencia, Xtreme

PRICE GROUP 3: Chili, Moulin-Fr, Silvertex, Step/Step Melange

PRICE GROUP 4: Blazer, Focus Royal, Main Line Flax, skai Parotega, Synergy

PRICE GROUP 5: Remix 3

PRICE GROUP 6: Nappa leather (not available for high panels)

| | | | | | CREVA LANDSCAPE 2/2 CUBE ZS DS |
|---|---|--------------------------|---------------|--------------------|--------------------------------|
| | None | | | | • |
| Movable tablet (for solid wood base, table top in base colour) | Arm: Powder- coated steel, Jet black, RAL 9005 | Table top: Solid wood | Natural beech | 1 szt. MTF-①/BK-J1 | 153 |
| | | | | 2 szt. MTF-①/BK-J2 | 305 |
| | | | Stained beech | 1 szt. MTF-①/BK-J1 | 156 |
| | | | | 2 szt. MTF-①/BK-J2 | 314 |
| | | | Natural oak | 1 szt. MTF-①/BK-J1 | 163 |
| | | | | 2 szt. MTF-①/BK-J2 | 324 |
| Foam | Flame retardant foam | | FFR2 | • | |
| Glides | Plastic glides | | GD | • | |
| | Nonskid glides | | GDN | 14 | |
| Wood and wood-based materials | Raw material – EU timber regulation, from certified forests, FSC certificate – authorized companies | | FSC | • | |
| Assembly | Partially Assembled, cardboard packaging (seats with assembled base and panels) | | PACK-A | • | |
| | Unassembled, cardboard packaging (seat with assembled base) | | PACK-UA | ○ | |
| Sample order | CREVA LANDSCAPE 2/2 CUBE ZS DS (V-L SBC-CUZ63 P-H-LDS17 A-YKU1/B-YKU2-FR BC-BK MTF-SKNB/BK-J1 FFR2 GD FSC PACK-A) | | | | |

① – Please specify wood colour code – see finishes

- Available as standard (included in basic price)
- Available as an option (included in basic price)

Price list

Creva Landscape 2/2 Cube H double-sided

Seats, high panels and cushions – upholstered, flame retardant foam.
Cushions connecting to panels with Velcro type fixing.
Base – powder-coated metal legs as standard or solid wood as an option, plastic glides in black colour.

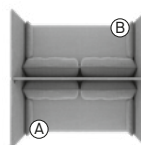

CREVA LANDSCAPE 2/2 CUBE SH DS

W 1506 mm
D 1498 mm
H 1387 mm
SH 462 mm
SH DIN 400 mm
WT 59,2 kg

Basic price (EUR)
according to upholstery price group

| | | | | | |
|--|---|---------------------|--------------------|-------------------|------|
| | Price group 2 | | | | 3240 |
| | Price group 3 | | | | 3420 |
| | Price group 4 | | | | 3708 |
| | Price group 5 | | | | 3837 |
| | Price group 6 | | | | 4987 |
| Finish: seats, backrest cushions, side cushions | Upholstery | | SBC- ^⑤ | | • |
| | | 2 | | | 1751 |
| | | 3 | | | 1990 |
| Panels finish | High panels, upholstered | Price group: | 4 | P-H- ^⑤ | 2297 |
| | | | 5 | | 2581 |
| | | | 6 | | — |
| Media (sofas, location A/B) | None | | | | • |
| | A – 1 × PIP 1 × power socket, cable length 3000 mm | | A-YKU1/B- | | |
| | B – 1 × PIP 1 × double USB charger (type A + C), cable length 3000 mm | | YKU2- ^⑧ | | 450 |
| | Powder-coated steel | Jet black, RAL 9005 | BC-BK | | • |
| Base finish | | Natural beech | | | 189 |
| | Solid wood | Stained beech | BC- ^① | | 200 |
| | | Natural oak | | | 236 |

^⑤ – Please specify upholstery colour code from selected price group – [see finishes](#)

^① – Media ports positioning

^② – Media ports positioning

^③ – Please specify media port standard: CH13, FR, GB, GE

• Available as standard (included in basic price)

To complete product configuration select options on next pages →

PRICE GROUP 2: Boogie, Cura, Cura Loop, Home, Valencia, Xtreme
PRICE GROUP 3: Chili, Moulin-Fr, Silvertex, Step/Step Melange
PRICE GROUP 4: Blazer, Focus Royal, Main Line Flax, skai Parotega, Synergy
PRICE GROUP 5: Remix 3
PRICE GROUP 6: Nappa leather (not available for high panels)

| | | | | CREVA LANDSCAPE 2/2 CUBE SH DS | |
|---|---|--------------------------|---------------|--------------------------------|-----|
| | None | | | • | |
| Movable tablet (for solid wood base, table top in base colour) | Arm: Powder-coated steel, Jet black, RAL 9005 | Table top: Solid wood | Natural beech | 1 szt. MTF-①/BK-J1 | 153 |
| | | | | 2 szt. MTF-①/BK-J2 | 305 |
| | | | Stained beech | 1 szt. MTF-①/BK-J1 | 156 |
| | | | | 2 szt. MTF-①/BK-J2 | 314 |
| | | | Natural oak | 1 szt. MTF-①/BK-J1 | 163 |
| | | | | 2 szt. MTF-①/BK-J2 | 324 |
| Foam | Flame retardant foam | | FFR2 | • | |
| Glides | Plastic glides | | GD | • | |
| | Nonskid glides | | GDN | 14 | |
| Wood and wood-based materials | Raw material – EU timber regulation, from certified forests, FSC certificate – authorized companies | | FSC | • | |
| Assembly | Partially Assembled, cardboard packaging (seats with assembled base and panels) | | PACK-A | • | |
| | Unassembled, cardboard packaging (seat with assembled base) | | PACK-UA | ○ | |
| Sample order | CREVA LANDSCAPE 2/2 CUBE SH DS (SBC-CUZ63 P-H-LDS17 A-YKU1/B-YKU2-FR BC-BK MTF-SKNB/BK-J1 FFR2 GD FSC PACK-A) | | | | |

① – Please specify wood colour code – [see finishes](#)

- Available as standard (included in basic price)
- Available as an option (included in basic price)

Price list

Creva Landscape 2/T/2 linear one-sided

Seats, low panels and cushions – upholstered, flame retardant foam.
 Cushions connecting to panels with Velcro type fixing.
 Upholstered table with square table top.
 Base – powder-coated metal legs as standard or made of solid wood as an option, plastic glides in black colour.



CREVA LANDSCAPE 2/T/2 LN OS

| | |
|--|--|
| Arrangement: W 3676 mm D 763 mm H 873 mm SH 462 mm SH DIN 400 mm WT 105,6 kg | Table: W 720 mm D 720 mm H 385 mm |
|--|--|

Basic price (EUR)
according to upholstery price group

| | | | | | |
|---|---|--------------|---|--------------------|------|
| | Price group 2 | | | | 3645 |
| | Price group 3 | | | | 3821 |
| | Price group 4 | | | | 4104 |
| | Price group 5 | | | | 4230 |
| | Price group 6 | | | | 5498 |
| Finish: seats, table carcass, backrest cushions, side cushions | Upholstery | | | | • |
| | | | 2 | | 824 |
| | | | 3 | | 924 |
| Panels finish | Low panels, upholstered | Price group: | 4 | P-L- ^⑤ | 1040 |
| | | | 5 | | 1186 |
| | | | 6 | | 1542 |
| | Melamine faced chipboard (MFC) | | | | • |
| Table top finish | Laminate | | | TF- ^① | 50 |
| | Fenix NTM® | | | | 73 |
| Media (sofas, location A/B) | None | | | | • |
| | A – 1 × PIP 1 × power socket, cable length 3000 mm | | | A-YKU1/B- | |
| | B – 1 × PIP 1 × double USB charger (type A + C), cable length 3000 mm | | | YKU2- ^⑧ | 450 |

^① – Please specify colour code of table top – [see finishes](#)

^⑤ – Please specify upholstery colour code from selected price group – [see finishes](#)

^⑧ – Please specify media port standard: CH13, FR, GB, GE

[Ⓐ] – Media ports positioning

[Ⓑ] – Media ports positioning

• Available as standard (included in basic price)

To complete product configuration select options on next pages →

PRICE GROUP 2: Boogie, Cura, Cura Loop, Home, Valencia, Xtreme
 PRICE GROUP 3: Chili, Moulin-Fr, Silvertex, Step/Step Melange
 PRICE GROUP 4: Blazer, Focus Royal, Main Line Flax, skai Parotega, Synergy
 PRICE GROUP 5: Remix 3
 PRICE GROUP 6: Nappa leather

| | | | | CREVA LANDSCAPE 2/T/2 LN OS | |
|---|---|---------------------|----------------------|-----------------------------|------|
| Base finish | Powder-coated steel | Jet black, RAL 9005 | BC-BK | • | |
| | Solid wood | Natural beech | | 283 | |
| | | Stained beech | BC-① | 300 | |
| | | Natural oak | | 353 | |
| Movable tablet (for solid wood base, table top in base colour) | None | | | • | |
| | Arm: Powder-coated steel, Jet black, RAL 9005 Table top: solid wood | Natural beech | 1 szt. MTF-①/BK-J1 | 153 | |
| | | | 2 szt. MTF-①/BK-J2 | 305 | |
| | | Stained beech | 1 szt. MTF-①/BK-J1 | 156 | |
| | | | 2 szt. MTF-①/BK-J2 | 314 | |
| | | Natural oak | 1 szt. MTF-①/BK-J1 | 163 | |
| | | | 2 szt. MTF-①/BK-J2 | 324 | |
| | | Foam | Flame retardant foam | | FFR2 |
| Glides | | Plastic glides | | GD | • |
| | Nonskid glides | | GDN | 20 | |
| Wood and wood-based materials | Raw material – EU timber regulation | | EUTR | • | |
| Assembly | Partially Assembled, cardboard packaging (seats with assembled base and panels) | | PACK-A | • | |
| | Unassembled, cardboard packaging (seats with assembled base) | | PACK-UA | ○ | |
| Sample order | CREVA LANDSCAPE 2/T/2 LN OS (SBC-CUZ63 P-L-LDS17 TF-KM A-YKU1/B-YKU2-FR BC-BK MTF-SKNB/BK-J1 FFR2 GD EUTR PACK-A) | | | | |

- ① – Please specify wood colour code – [see finishes](#)
- Available as standard (included in basic price)
 - Available as an option (included in basic price)

Price list

Creva Landscape 2/T/1 linear one-sided

Seats, low panels and cushions – upholstered, flame retardant foam.
Cushions connecting to panels with Velcro type fixing.
Upholstered table with square table top.
Base – powder-coated metal legs as standard or solid wood as an option, plastic glides in black colour.

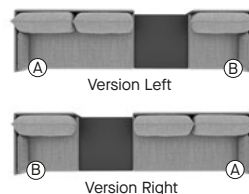

CREVA LANDSCAPE 2/T/1 LN OS

| | |
|---|--|
| Arrangement: W 2946 mm D 763 mm H 873 mm SH 462 mm SH DIN 400 mm WT 90,3 kg | Table: W 720 mm D 720 mm H 385 mm |
|---|--|

Basic price (EUR)
according to upholstery price group

| | | | | |
|---|---|-----------------|-------|------|
| | Price group 2 | | | 3121 |
| | Price group 3 | | | 3268 |
| | Price group 4 | | | 3491 |
| | Price group 5 | | | 3590 |
| | Price group 6 | | | 4666 |
| Version | Left | V-L | | • |
| | Right | V-R | | ○ |
| Finish: seats, table carcass, backrest cushions, side cushions | Upholstery | SBC-⑤ | | • |
| | | | | |
| Panels finish | Low panels, upholstered | Price group: | 2 | 717 |
| | | | 3 | 799 |
| | | | 4 | 901 |
| | | | 5 | 1024 |
| | | | 6 | 1331 |
| | | | P-L-⑤ | |
| Table top finish | Melamine faced chipboard (MFC) | | | • |
| | Laminate | TF-① | | 50 |
| | Fenix NTM® | | | 73 |
| Media (sofas, location A/B) | None | | | • |
| | A – 1 × PIP 1 × power socket, cable length 3000 mm B – 1 × PIP 1 × double USB charger (type A + C), cable length 3000 mm | A-YKU1/B-YKU2-⑧ | | 450 |

① – Please specify colour code of table top – see finishes

⑤ – Please specify upholstery colour code from selected price group – see finishes

⑧ – Please specify media port standard: CH13, FR, GB, GE

Ⓐ – Media ports positioning

Ⓑ – Media ports positioning

• Available as standard (included in basic price)

○ Available as an option (included in basic price)

To complete product configuration select options on next pages →

PRICE GROUP 2: Boogie, Cura, Cura Loop, Home, Valencia, Xtreme
PRICE GROUP 3: Chili, Moulin-Fr, Silvertex, Step/Step Melange
PRICE GROUP 4: Blazer, Focus Royal, Main Line Flax, skai Parotega, Synergy
PRICE GROUP 5: Remix 3
PRICE GROUP 6: Nappa leather

| | | | | CREVA LANDSCAPE 2/T/1 LN OS |
|---|---|---------------------|--------------------|-----------------------------|
| Base finish | Powder-coated steel | Jet black, RAL 9005 | BC-BK | • |
| | Solid wood | Natural beech | BC-① | 283 |
| | | Stained beech | | 300 |
| | | Natural oak | | 353 |
| None | | | | • |
| Movable tablet (for solid wood base, table top in base colour) | Arm: Powder-coated steel, Jet black, RAL 9005 Table top: solid wood | Natural beech | 1 szt. MTF-①/BK-J1 | 153 |
| | | | 2 szt. MTF-①/BK-J2 | 305 |
| | | Stained beech | 1 szt. MTF-①/BK-J1 | 156 |
| | | | 2 szt. MTF-①/BK-J2 | 314 |
| | | Natural oak | 1 szt. MTF-①/BK-J1 | 163 |
| | | | 2 szt. MTF-①/BK-J2 | 324 |
| Foam | Flame retardant foam | | FFR2 | • |
| Glides | Plastic glides | | GD | • |
| | Nonskid glides | | GDN | 20 |
| Wood and wood-based materials | Raw material – EU timber regulation | | EUTR | • |
| Assembly | Partially Assembled, cardboard packaging (seats with assembled base and panels) | | PACK-A | • |
| | Unassembled, cardboard packaging (seats with assembled base) | | PACK-UA | ○ |
| Sample order | CREVA LANDSCAPE 2/T/1 LN OS (V-L SBC-CUZ63 P-L-LDS17 TF-KM A-YKU1/B-YKU2-FR BC-BK MTF-SKNB/BK-J1 FFR2 GD EUTR PACK-A) | | | |

① – Please specify wood colour code – see finishes

- Available as standard (included in basic price)
- Available as an option (included in basic price)

Price list

Creva Landscape 1/TP/1 linear one-sided

Seats, low or high panels and cushions – upholstered, flame retardant foam.

Cushions connecting to panels with Velcro type fixing.

Upholstered table with square table top.

Base – powder-coated metal legs as standard or made of solid wood as an option, plastic glides in black colour.

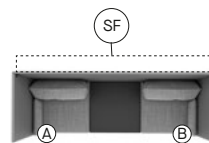

CREVA LANDSCAPE 1/TP/1 LN OS

| | |
|---|--|
| Arrangement: W 2236 mm D 763 mm H 873/1387 mm* SH 462 mm SH DIN 400 mm WT 81,3 / 116,3 kg** | Table: W 720 mm D 720 mm H 385 mm |
|---|--|

Basic price (EUR)
according to upholstery price group

| | | | | | |
|---|--------------------------------|--------------|-------|-------|------|
| | Price group 2 | | | | 2719 |
| | Price group 3 | | | | 2844 |
| | Price group 4 | | | | 3012 |
| | Price group 5 | | | | 3091 |
| | Price group 6 | | | | 4017 |
| Finish: seats, table carcass, backrest cushions, side cushions | Upholstery | | SBC-⑤ | | • |
| | | | | | |
| Panels finish | Low panels, upholstered | Price group: | 2 | P-L-⑤ | 762 |
| | | | 3 | | 841 |
| | | | 4 | | 952 |
| | | | 5 | | 1074 |
| | | | 6 | | 1396 |
| | | | | | |
| High panels, upholstered | Price group: | 2 | P-H-⑤ | 1521 | |
| | | 3 | | 1689 | |
| | | 4 | | 1931 | |
| | | 5 | | 2143 | |
| | | 6 | | — | |
| | | | | | |
| Table top finish | Melamine faced chipboard (MFC) | | | | • |
| | Laminate | | TF-① | | 50 |
| | Fenix NTM® | | | | 73 |

* – x / y cm - x: overall height with low panel / y: overall height with high panel

** – x / y kg - x: overall weight with low panel / y: overall weight with high panel

① – Please specify colour code of table top – [see finishes](#)

⑤ – Please specify upholstery colour code from selected price group – [see finishes](#)

Ⓐ – Media ports positioning

Ⓑ – Media ports positioning

Ⓕ – Working shelf positioning

• Available as standard (included in basic price)

To complete product configuration select options on next pages →

PRICE GROUP 2: Boogie, Cura, Cura Loop, Home, Valencia, Xtreme

PRICE GROUP 3: Chili, Moulin-Fr, Silvertex, Step / Step Melange

PRICE GROUP 4: Blazer, Focus Royal, Main Line Flax, skai Parotega, Synergy

PRICE GROUP 5: Remix 3

PRICE GROUP 6: Nappa leather (not available for high panels)

| | | | | CREVA LANDSCAPE 1/TP/1 LN OS |
|---|---|-----------------------------|---------------------------------|------------------------------|
| Working shelf (available for high panels only), working shelf, in table top finish | None | | | • |
| | Melamine faced chipboard (MFC) | | | 167 |
| | Laminate | SF- ^① | | 320 |
| | Fenix NTM® | | | 543 |
| Media (sofas, location A/B) | None | | | • |
| | A – 1 × PIP 1 × power socket, cable length 3000 mm B – 1 × PIP 1 × double USB charger (type A + C), cable length 3000 mm | A-YKU1/B-YKU2- ^⑧ | | 450 |
| Base finish | Powder-coated steel | Jet black, RAL 9005 | BC-BK | • |
| | | Natural beech | | 283 |
| | Solid wood | Stained beech | BC- ^① | 300 |
| | | Natural oak | | 353 |
| Movable tablet (for solid wood base, table top in base colour) | None | | | • |
| | | Natural beech | 1 szt. MTF- ^① /BK-J1 | 153 |
| | | | 2 szt. MTF- ^① /BK-J2 | 305 |
| | Arm: Powder-coated steel, Jet black, RAL 9005 Table top: Solid wood | Stained beech | 1 szt. MTF- ^① /BK-J1 | 156 |
| | | | 2 szt. MTF- ^① /BK-J2 | 314 |
| | | Natural oak | 1 szt. MTF- ^① /BK-J1 | 163 |
| | | | 2 szt. MTF- ^① /BK-J2 | 324 |
| | Foam | Flame retardant foam | FFR2 | • |
| Glides | Plastic glides | GD | • | |
| | Nonskid glides | GDN | 20 | |
| Wood and wood-based materials | Raw material – EU timber regulation | EUTR | • | |
| Assembly | Partially Assembled, cardboard packaging (seats with assembled base and panels) | PACK-A | • | |
| | Unassembled, cardboard packaging (seats with assembled base) | PACK-UA | ○ | |
| Sample order | CREVA LANDSCAPE 1/TP/1 LN OS (SBC-CUZ63 P-H-LDS17 TF-KM BC-BK FFR2 GD EUTR PACK-A) | | | |
| | CREVA LANDSCAPE 1/TP/1 LN OS (SBC-CUZ63 P-H-LDS17 TF-KM SF-KM A-YKU1/B-YKU2-FR BC-BK MTF-SKNB/BK-J1 FFR2 GD EUTR PACK-A) | | | |

① – Please specify wood colour code – see finishes

⑧ – Please specify media port standard: CH13, FR, GB, GE

• Available as standard (included in basic price)

○ Available as an option (included in basic price)

Price list

Creva Landscape 2/T/2 linear double-sided

Seats, low panels and cushions – upholstered, flame retardant foam.
Cushions connecting to panels with Velcro type fixing.
Upholstered table with square table top.
Base – powder-coated metal legs as standard or solid wood as an option, plastic glides in black colour.

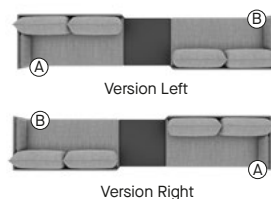

CREVA LANDSCAPE 2/T/2 LN DS

| | |
|--|--|
| Arrangement: W 3676 mm D 791 mm H 873 mm SH 462 mm SH DIN 400 mm WT 105,6 kg | Table: W 720 mm D 720 mm H 385 mm |
|--|--|

Basic price (EUR)
according to upholstery price group

| | | | | |
|---|--------------------------------|--------------|---------|------|
| | Price group 2 | | | 3645 |
| | Price group 3 | | | 3821 |
| | Price group 4 | | | 4104 |
| | Price group 5 | | | 4230 |
| | Price group 6 | | | 5498 |
| Version | Left | V-L | | • |
| | Right | V-R | | • |
| Finish: seats, table carcass, backrest cushions, side cushions | Upholstery | SBC-⑤ | | • |
| | | | | |
| Panels finish | Low panels, upholstered | Price group: | 2 | 824 |
| | | | 3 | 924 |
| | | | 4 P-L-⑤ | 1040 |
| | | | 5 | 1186 |
| | | | 6 | 1542 |
| Table top finish | Melamine faced chipboard (MFC) | | | • |
| | Laminate | TF-① | | 50 |
| | Fenix NTM® | | | 73 |

① – Please specify colour code of table top – see finishes

⑤ – Please specify upholstery colour code from selected price group – see finishes

⑧ – Please specify media port standard: CH13, FR, GB, GE

Ⓐ – Media ports positioning

Ⓑ – Media ports positioning

• Available as standard (included in basic price)

○ Available as an option (included in basic price)

To complete product configuration select options on next pages →

PRICE GROUP 2: Boogie, Cura, Cura Loop, Home, Valencia, Xtreme
PRICE GROUP 3: Chili, Moulin-Fr, Silvertex, Step/Step Melange
PRICE GROUP 4: Blazer, Focus Royal, Main Line Flax, skai Parotega, Synergy
PRICE GROUP 5: Remix 3
PRICE GROUP 6: Nappa leather

| | | | | CREVA LANDSCAPE 2/T/2 LN DS |
|---|---|----------------------|-----------------|-----------------------------|
| Media (sofas, location A/B) | None | | | • |
| | A – 1 × PIP 1 × power socket, cable length 3000 mm | | A-YKU1/B-YKU2-⑧ | 450 |
| Base finish | Powder-coated steel | Jet black, RAL 9005 | BC-BK | • |
| | Solid wood | Natural beech | | 283 |
| | | Stained beech | BC-① | 300 |
| | | Natural oak | | 353 |
| Movable tablet (for solid wood base, table top in base colour) | None | | | • |
| | Natural beech | 1 szt. | MTF-①/BK-J1 | 153 |
| | | 2 szt. | MTF-①/BK-J2 | 305 |
| | Stained beech | 1 szt. | MTF-①/BK-J1 | 156 |
| | | 2 szt. | MTF-①/BK-J2 | 314 |
| | Natural oak | 1 szt. | MTF-①/BK-J1 | 163 |
| | | 2 szt. | MTF-①/BK-J2 | 324 |
| | Foam | Flame retardant foam | | FFR2 |
| Glides | Plastic glides | | GD | • |
| | Nonskid glides | | GDN | 20 |
| Wood and wood-based materials | Raw material – EU timber regulation | | EUTR | • |
| Assembly | Partially Assembled, cardboard packaging (seats with assembled base and panels) | | PACK-A | • |
| | Unassembled, cardboard packaging (seats with assembled base) | | PACK-UA | ○ |
| Sample order | CREVA LANDSCAPE 2/T/2 LN DS (V-L SBC-CUZ63 P-L-LDS17 TF-KM A-YKU1/B-YKU2-FR BC-BK MTF-SKNB/BK-J1 FFR2 GD EUTR PACK-A) | | | |

① – Please specify wood colour code – [see finishes](#)

⑧ – Please specify media port standard: CH13, FR, GB, GE

- Available as standard (included in basic price)
- Available as an option (included in basic price)

Price list

Creva Landscape 2/1 linear double-sided

Seats, low or high panels and cushions – upholstered, flame retardant foam.
Cushions connecting to panels with Velcro type fixing.
Base – powder-coated metal legs as standard or made of solid wood as an option, plastic glides in black colour.

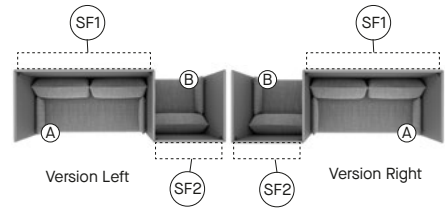

CREVA LANDSCAPE 2/1 LN DS

W 2254 mm
D 791 mm
H 873 / 1387 mm*
SH 462 mm
SH DIN 400 mm
WT 85,8 / 129,3 kg**

Basic price (EUR)
according to upholstery price group

| | | | | |
|--|--------------------------|--------------|-------|------|
| | Price group 2 | | | 2704 |
| | Price group 3 | | | 2854 |
| | Price group 4 | | | 3080 |
| | Price group 5 | | | 3183 |
| | Price group 6 | | | 4138 |
| Version | Left | V-L | | • |
| | Right | V-R | | ○ |
| Finish: seats, backrest cushions, side cushions | Upholstery | SBC-⑤ | | • |
| | | | | |
| Panels finish | Low panels, upholstered | Price group: | 2 | 863 |
| | | | 3 | 961 |
| | | | 4 | 1083 |
| | | | 5 | 1231 |
| | | | 6 | 1600 |
| | | | P-L-⑤ | |
| | High panels, upholstered | Price group: | 2 | 1782 |
| | | | 3 | 2006 |
| | | | 4 | 2305 |
| | | | 5 | 2577 |
| P-H-⑤ | | | | |
| | | | 6 | — |

* – x/y cm - x: overall height with low panel / y: overall height with high panel

** – x/y kg - x: overall weight with low panel / y: overall weight with high panel

① – Please specify colour code of working shelf – [see finishes](#)

⑤ – Please specify upholstery colour code from selected price group – [see finishes](#)

Ⓐ – Media ports positioning

Ⓑ – Media ports positioning

ⓈF1 – Working shelf positioning

ⓈF2 – Working shelf positioning

• Available as standard (included in basic price)

○ Available as an option (included in basic price)

To complete product configuration select options on next pages →

PRICE GROUP 2: Boogie, Cura, Cura Loop, Home, Valencia, Xtreme
PRICE GROUP 3: Chili, Moulin-Fr, Silvertex, Step/Step Melange
PRICE GROUP 4: Blazer, Focus Royal, Main Line Flax, skai Parotega, Synergy
PRICE GROUP 5: Remix 3
PRICE GROUP 6: Nappa leather (not available for high panels)

| | | | | CREVA LANDSCAPE 2/1 LN DS | |
|---|---|-----------------------------|----------------------|---------------------------|------|
| Working shelf SF1 (available for high panels only) | None | | | • | |
| | Melamine faced chipboard (MFC) | | | 142 | |
| | Laminate | | SF1-① | 275 | |
| | Fenix NTM® | | | 319 | |
| Working shelf SF2 (available for high panels only) | None | | | • | |
| | Melamine faced chipboard (MFC) | | | 117 | |
| | Laminate | | SF2-① | 198 | |
| | Fenix NTM® | | | 233 | |
| Media (sofas, location A/B) | None | | | • | |
| | A – 1 × PIP 1 × power socket, cable length 3000 mm B – 1 × PIP 1 × double USB charger (type A + C), cable length 3000 mm | | A-YKU1/B-YKU2-⑧ | 450 | |
| Base finish | Powder-coated steel | Jet black, RAL 9005 | BC-BK | • | |
| | | Natural beech | | 189 | |
| | Solid wood | Stained beech | BC-① | 200 | |
| | | Natural oak | | 236 | |
| Movable tablet (for solid wood base, table top in base colour) | None | | | • | |
| | Arm: Powder-coated steel, Jet black, RAL 9005 Table top: Solid wood | Natural beech | 1 szt. | MTF-①/BK-J1 | 153 |
| | | | 2 szt. | MTF-①/BK-J2 | 305 |
| | | Stained beech | 1 szt. | MTF-①/BK-J1 | 156 |
| | | | 2 szt. | MTF-①/BK-J2 | 314 |
| | | Natural oak | 1 szt. | MTF-①/BK-J1 | 163 |
| | | | 2 szt. | MTF-①/BK-J2 | 324 |
| | | Foam | Flame retardant foam | | FFR2 |
| Glides | | Plastic glides | | GD | • |
| | Nonskid glides | | GDN | 20 | |
| Wood and wood-based materials | Raw material – EU timber regulation, from certified forests, FSC certificate – authorized companies | (for model without a shelf) | FSC | • | |
| | Raw material – EU timber regulation | (for model with a shelf) | EUTR | | |
| Assembly | Partially Assembled, cardboard packaging (seats with assembled base and panels) | | PACK-A | • | |
| | Unassembled, cardboard packaging (seat with assembled base) | | PACK-UA | ○ | |
| Sample order | CREVA LANDSCAPE 2/1 LN DS (V-L SBC-CUZ63 P-H-LDS17 BC-BK FFR2 GD EUTR PACK-A) | | | | |
| | CREVA LANDSCAPE 2/1 LN DS (V-L SBC-CUZ63 P-H-LDS17 SF1-KM SF2-KM A-YKU1/B-YKU2-FR BC-BK MTF-SKNB/BK-J1 FFR2 GD EUTR PACK-A) | | | | |

① – Please specify wood colour code – see finishes

⑧ – Please specify media port standard: CH13, FR, GB, GE

• Available as standard (included in basic price)

○ Available as an option (included in basic price)

Price list

Creva Landscape 1/TP/TP/1 linear double-sided

Seats, low or high panels and cushions – upholstered, flame retardant foam.

Cushions connecting to panels with Velcro type fixing.

Upholstered tables with square table top.

Base – powder-coated metal legs as standard or made of solid wood as an option, plastic glides in black colour.

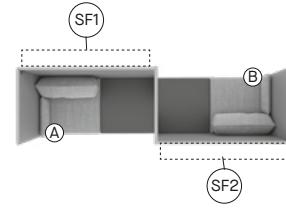

CREVA LANDSCAPE 1/TP/TP/1 LN DS

| | |
|--|--|
| Arrangement: W 2984 mm D 791 mm H 873/1387 mm* SH 462 mm SH DIN 400 mm WT 105,9 / 155,4 kg** | Table: W 720 mm D 720 mm H 385 mm |
|--|--|

Basic price (EUR)
according to upholstery price group

| | | | | | |
|---|--------------------------------|--------------|-------|---------|------|
| | Price group 2 | | | | 3134 |
| | Price group 3 | | | | 3255 |
| | Price group 4 | | | | 3420 |
| | Price group 5 | | | | 3495 |
| | Price group 6 | | | | 4542 |
| Finish: seats, table carcasses, backrest cushions, side cushions | Upholstery | | SBC-⑤ | | • |
| | | | | 2 | 961 |
| | | | | 3 | 1078 |
| | Low panels, upholstered | Price group: | | 4 P-L-⑤ | 1213 |
| | | | | 5 | 1385 |
| | | | | 6 | 1800 |
| Panels finish | | | | | |
| | | | | 2 | 2042 |
| | | | | 3 | 2322 |
| | High panels, upholstered | Price group: | | 4 P-H-⑤ | 2680 |
| | | | | 5 | 3011 |
| | | | | 6 | — |
| | Melamine faced chipboard (MFC) | | | | • |
| Table tops finish | Laminate | | TF-① | | 99 |
| | Fenix NTM® | | | | 146 |

* – x / y cm - x: overall height with low panel / y: overall height with high panel

** – x / y kg - x: overall weight with low panel / y: overall weight with high panel

① – Please specify colour code of table top – see finishes

⑤ – Please specify upholstery colour code from selected price group – see finishes

Ⓐ – Media ports positioning

Ⓑ – Media ports positioning

ⓈF1 – Working shelf positioning

ⓈF2 – Working shelf positioning

• Available as standard (included in basic price)

To complete product configuration select options on next pages →

PRICE GROUP 2: Boogie, Cura, Cura Loop, Home, Valencia, Xtreme
 PRICE GROUP 3: Chili, Moulin-Fr, Silvertex, Step / Step Melange
 PRICE GROUP 4: Blazer, Focus Royal, Main Line Flax, skai Parotega, Synergy
 PRICE GROUP 5: Remix 3
 PRICE GROUP 6: Nappa leather (not available for high panels)

| | | | | CREVA LANDSCAPE 1/TP/TP/1 LN DS |
|---|---|---------------------|-------------|---------------------------------|
| Working shelf SF1 (available for high panels only), in table tops finish | None | | | • |
| | Melamine faced chipboard (MFC) | | | 142 |
| | Laminate | SF1-① | | 275 |
| | Fenix NTM® | | | 319 |
| Working shelf SF2 (available for high panels only), in table tops finish | None | | | • |
| | Melamine faced chipboard (MFC) | | | 142 |
| | Laminate | SF2-① | | 400 |
| | Fenix NTM® | | | 319 |
| Media (sofas, location A/B) | None | | | • |
| | A – 1 × PIP 1 × power socket, cable length 3000mm B – 1 × PIP 1 × double USB charger (type A + C), cable length 3000mm | A-YKU1/B-YKU2-⑧ | | 450 |
| Base finish | Powder-coated steel | Jet black, RAL 9005 | BC-BK | • |
| | Solid wood | Natural beech | | 377 |
| | | Stained beech | BC-① | 400 |
| | | Natural oak | | 471 |
| Movable tablet (for solid wood base, table top in base colour) | None | | | • |
| | Natural beech | 1 szt. | MTF-①/BK-J1 | 153 |
| | | 2 szt. | MTF-①/BK-J2 | 305 |
| | Stained beech | 1 szt. | MTF-①/BK-J1 | 156 |
| | | 2 szt. | MTF-①/BK-J2 | 314 |
| | Natural oak | 1 szt. | MTF-①/BK-J1 | 163 |
| 2 szt. | | MTF-①/BK-J2 | 324 | |
| Foam | Flame retardant foam | FFR2 | | • |
| Glides | Plastic glides | GD | | • |
| | Nonskid glides | GDN | | 28 |
| Wood and wood-based materials | Raw material – EU timber regulation | EUTR | | • |
| Assembly | Partially Assembled, cardboard packaging (seats with assembled base and panels) | PACK-A | | • |
| | Unassembled, cardboard packaging (seats with assembled base) | PACK-UA | | ○ |
| Sample order | CREVA LANDSCAPE 1/TP/TP/1 LN DS (SBC-CUZ63 P-H-LDS17 TF-KM BC-BK FFR2 GD EUTR PACK-A) | | | |
| | CREVA LANDSCAPE 1/TP/TP/1 LN DS (SBC-CUZ63 P-H-LDS17 TF-KM SF1-KM SF2-KM A-YKU1/B-YKU2-FR BC-BK MTF-SKBN/BK-J1 FFR2 GD EUTR PACK-A) | | | |

① – Please specify wood colour code – see finishes

⑧ – Please specify media port standard: CH13, FR, GB, GE

• Available as standard (included in basic price)

○ Available as an option (included in basic price)

Price list

Creva Landscape 1/T/1 linear double-sided

Seats, low panels and cushions – upholstered, flame retardant foam.
 Cushions connecting to panels with Velcro type fixing.
 Upholstered table with square table top.
 Base – powder-coated metal legs as standard or made of solid wood as an option, plastic glides in black colour.



CREVA LANDSCAPE 1/T/1 LN DS

| | |
|---|--|
| Arrangement: W 2236 mm D 791 mm H 873 mm SH 462 mm SH DIN 400 mm WT 74,7 kg | Table: W 720 mm D 720 mm H 385 mm |
|---|--|

Basic price (EUR)
according to upholstery price group

| | | |
|---|---|----------------------|
| Price group 2 | | 2598 |
| Price group 3 | | 2716 |
| Price group 4 | | 2877 |
| Price group 5 | | 2950 |
| Price group 6 | | 3836 |
| Finish: seats, table carcass, backrest cushions, side cushions | Upholstery | SBC-⑤ |
| | | • |
| | | 2 |
| | | 3 |
| Panels finish | Low panels, upholstered | Price group: 4 P-L-⑤ |
| | | 5 |
| | | 6 |
| | Melamine faced chipboard (MFC) | |
| Table top finish | Laminate | TF-① |
| | Fenix NTM® | |
| | | • |
| | | 50 |
| | | 73 |
| Media (sofas, location A/B) | None | |
| | A – 1 × PIP 1 × power socket, cable length 3000 mm | A-YKU1/B- |
| | B – 1 × PIP 1 × double USB charger (type A+C), cable length 3000 mm | YKU2-⑧ |
| | | 450 |

① – Please specify colour code of table top – [see finishes](#)

⑤ – Please specify upholstery colour code from selected price group – [see finishes](#)

⑧ – Please specify media port standard: CH13, FR, GB, GE

Ⓐ – Media ports positioning

Ⓑ – Media ports positioning

• Available as standard (included in basic price)

To complete product configuration select options on next pages →

PRICE GROUP 2: Boogie, Cura, Cura Loop, Home, Valencia, Xtreme
 PRICE GROUP 3: Chili, Moulin-Fr, Silvertex, Step/Step Melange
 PRICE GROUP 4: Blazer, Focus Royal, Main Line Flax, skai Parotega, Synergy
 PRICE GROUP 5: Remix 3
 PRICE GROUP 6: Nappa leather

| | | | | CREVA LANDSCAPE 1/T/1 LN DS |
|---|---|---------------------|--------------------|-----------------------------|
| Base finish | Powder-coated steel | Jet black, RAL 9005 | BC-BK | • |
| | Solid wood | Natural beech | BC-① | 283 |
| | | Stained beech | | 300 |
| | | Natural oak | | 353 |
| None | | | | • |
| Movable tablet (for solid wood base, table top in base colour) | Arm: Powder-coated steel, Jet black, RAL 9005 Table top: Solid wood | Natural beech | 1 szt. MTF-①/BK-J1 | 153 |
| | | | 2 szt. MTF-①/BK-J2 | 305 |
| | | Stained beech | 1 szt. MTF-①/BK-J1 | 156 |
| | | | 2 szt. MTF-①/BK-J2 | 314 |
| | | Natural oak | 1 szt. MTF-①/BK-J1 | 163 |
| | | | 2 szt. MTF-①/BK-J2 | 324 |
| Foam | Flame retardant foam | | FFR2 | • |
| Glides | Plastic glides | | GD | • |
| | Nonskid glides | | GDN | 20 |
| Wood and wood- based materials | Raw material – EU timber regulation | | EUTR | • |
| Assembly | Partially Assembled, cardboard packaging (seats with assembled base and panels) | | PACK-A | • |
| | Unassembled, cardboard packaging (seats with assembled base) | | PACK-UA | ○ |
| Sample order | CREVA LANDSCAPE 1/T/1 LN DS (SBC-CUZ63 P-L-LDS17 TF-KM A-YKU1/B-YKU2-FR BC-BK MTF-SKNB/BK-J1 FFR2 GD EUTR PACK-A) | | | |

① – Please specify wood colour code – see finishes

- Available as standard (included in basic price)
- Available as an option (included in basic price)

Price list

Creva Landscape 2/TP/2 L-shape one-sided, internal

Seats, low or high panels and cushions – upholstered, flame retardant foam.

Cushions connecting to panels with Velcro type fixing.

Upholstered table with square table top.

Base – powder-coated metal legs as standard or made of solid wood as an option, plastic glides in black colour.

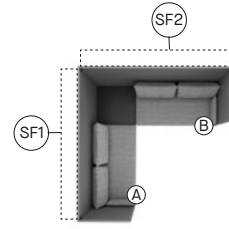

CREVA LANDSCAPE 2/TP/2 LS OS INT

| | |
|-----------------------|----------|
| Arrangement: | Table: |
| W 2236 mm | W 720 mm |
| D 2236 mm | D 720 mm |
| H 873 / 1387 mm* | H 385 mm |
| SH 462 mm | |
| SH DIN 400 mm | |
| WM 763 mm | |
| WT 121,4 / 176,4 kg** | |

Basic price (EUR)
according to upholstery price group

| | | | | |
|---|--------------------------------|--------------|---------|------|
| Price group 2 | | | | 3722 |
| Price group 3 | | | | 3901 |
| Price group 4 | | | | 4190 |
| Price group 5 | | | | 4318 |
| Price group 6 | | | | 5614 |
| Finish: seats, table carcass, backrest cushions, side cushions | Upholstery | SBC-⑤ | | • |
| Panels finish | Low panels, upholstered | Price group: | 2 | 1099 |
| | | | 3 | 1233 |
| | | | 4 P-L-⑤ | 1386 |
| | High panels, upholstered | Price group: | 5 | 1582 |
| | | | 6 | 2057 |
| | | | 4 P-H-⑤ | 3062 |
| Table top finish | Laminate | TF-① | 2 | 2334 |
| | | | 3 | 2654 |
| | | | 5 | 3441 |
| | Melamine faced chipboard (MFC) | | 6 | — |
| | Fenix NTM® | | | 73 |

* – x/y cm - x: overall height with low panel / y: overall height with high panel

** – x/y kg - x: overall weight with low panel / y: overall weight with high panel

① – Please specify colour code of table top – [see finishes](#)

⑤ – Please specify upholstery colour code from selected price group – [see finishes](#)

Ⓐ – Media ports positioning

Ⓑ – Media ports positioning

ⓄSF1 – Working shelf positioning

ⓄSF2 – Working shelf positioning

• Available as standard (included in basic price)

To complete product configuration select options on next pages →

PRICE GROUP 2: Boogie, Cura, Cura Loop, Home, Valencia, Xtreme
 PRICE GROUP 3: Chili, Moulin-Fr, Silvertex, Step/Step Melange
 PRICE GROUP 4: Blazer, Focus Royal, Main Line Flax, skai Parotega, Synergy
 PRICE GROUP 5: Remix 3
 PRICE GROUP 6: Nappa leather (not available for high panels)

| | | | | CREVA LANDSCAPE 2/TP/2 LS OS INT | |
|---|---|----------------------|--------------------|----------------------------------|-----|
| Working shelf SF1 (available for high panels only), working shelf, in table top finish | None | | | • | |
| | Melamine faced chipboard (MFC) | | | 167 | |
| | Laminate | SF1-① | | 320 | |
| | Fenix NTM® | | | 543 | |
| Working shelf SF2 (available for high panels only), working shelf, in table top finish | None | | | • | |
| | Melamine faced chipboard (MFC) | | | 167 | |
| | Laminate | SF2-① | | 320 | |
| | Fenix NTM® | | | 543 | |
| Media (sofas, location A/B) | None | | | • | |
| | A – 1 × PIP 1 × power socket, cable length 3000 mm B – 1 × PIP 1 × double USB charger (type A + C), cable length 3000 mm | A-YKU1/B-YKU2-⑧ | | 450 | |
| Base finish | Powder-coated steel | Jet black, RAL 9005 | BC-BK | • | |
| | | Natural beech | | 283 | |
| | Solid wood | Stained beech | BC-① | 300 | |
| | | Natural oak | | 353 | |
| Movable tablet (for solid wood base, table top in base colour) | None | | | • | |
| | | Natural beech | 1 szt. MTF-①/BK-J1 | 153 | |
| | | | 2 szt. MTF-①/BK-J2 | 305 | |
| | Arm: Powder-coated steel, Jet black, RAL 9005 Table top: Solid wood | Stained beech | 1 szt. MTF-①/BK-J1 | | 156 |
| | | | 2 szt. MTF-①/BK-J2 | | 314 |
| | | Natural oak | 1 szt. MTF-①/BK-J1 | | 163 |
| | | | 2 szt. MTF-①/BK-J2 | | 324 |
| | Foam | Flame retardant foam | FFR2 | | • |
| Glides | Plastic glides | GD | | • | |
| | Nonskid glides | GDN | | 20 | |
| Wood and wood-based materials | Raw material – EU timber regulation | EUTR | | • | |
| Assembly | Partially Assembled, cardboard packaging (seats with assembled base and panels) | PACK-A | | • | |
| | Unassembled, cardboard packaging (seats with assembled base) | PACK-UA | | ○ | |
| Sample order | CREVA LANDSCAPE 2/TP/2 LS OS INT (SBC-CUZ63 P-H-LDS17 TF-KM BC-BK FFR2 GD EUTR PACK-A) | | | | |
| | CREVA LANDSCAPE 2/TP/2 LS OS INT DS (SBC-CUZ63 P-H-LDS17 TF-KM SF1-KM SF2-KM A-YKU1/B-YKU2-FR BC-BK MTF-SKNB/BK-J1 FFR2 GD EUTR PACK-A) | | | | |

- ① – Please specify wood colour code – see finishes
 ⑧ – Please specify media port standard: CH13, FR, GB, GE
 • Available as standard (included in basic price)
 ○ Available as an option (included in basic price)

Price list

Creva Landscape 2/TP/2 L-shape one-sided, external

Seats, low or high panels and cushions – upholstered, flame retardant foam.

Cushions connecting to panels with Velcro type fixing.

Upholstered table with square table top.

Base – powder-coated metal legs as standard or made of solid wood as an option, plastic glides in black colour.

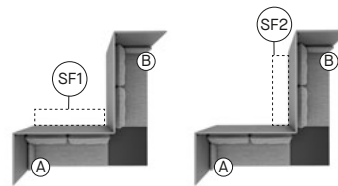

CREVA LANDSCAPE 2/TP/2 LS OS EX

Arrangement:
W 2236 mm
D 2236 mm
H 873 / 1387 mm*
SH 462 mm
SH DIN 400 mm
WM 763 mm
WT 105,6 / 147,6kg**

Table:
W 720 mm
D 720 mm
H 385 mm

Basic price (EUR)
according to upholstery price group

| | | | | | |
|---|--------------------------------|--------------|-------|-------|------|
| | Price group 2 | | | | 3645 |
| | Price group 3 | | | | 3821 |
| | Price group 4 | | | | 4104 |
| | Price group 5 | | | | 4230 |
| | Price group 6 | | | | 5498 |
| Finish: seats, table carcass, backrest cushions, side cushions | Upholstery | | SBC-⑤ | | • |
| | | | | | |
| Panels finish | Low panels, upholstered | Price group: | 2 | P-L-⑤ | 824 |
| | | | 3 | | 924 |
| | | | 4 | | 1040 |
| | | | 5 | | 1186 |
| | | | 6 | | 1542 |
| | | | | | |
| High panels, upholstered | Price group: | 2 | P-H-⑤ | 1751 | |
| | | 3 | | 1990 | |
| | | 4 | | 2297 | |
| | | 5 | | 2581 | |
| | | 6 | | — | |
| | | | | | |
| Table top finish | Melamine faced chipboard (MFC) | | | | • |
| | Laminate | | TF-① | | 50 |
| | Fenix NTM® | | | | 73 |

① – Please specify colour code of table top – [see finishes](#)

⑤ – Please specify upholstery colour code from selected price group – [see finishes](#)

Ⓐ – Media ports positioning

Ⓑ – Media ports positioning

ⓈF1 – Working shelf positioning

ⓈF2 – Working shelf positioning

• Available as standard (included in basic price)

To complete product configuration select options on next pages →

PRICE GROUP 2: Boogie, Cura, Cura Loop, Home, Valencia, Xtreme
PRICE GROUP 3: Chili, Moulin-Fr, Silvertex, Step/Step Melange
PRICE GROUP 4: Blazer, Focus Royal, Main Line Flax, skai Parotega, Synergy
PRICE GROUP 5: Remix 3
PRICE GROUP 6: Nappa leather

| | | | | CREVA LANDSCAPE 2/TP/2 LS OS EX | |
|---|--|----------------------|-----------------|---------------------------------|-----|
| Working shelf SF1 (available for high panels only), working shelf, in table top finish | None | | | | • |
| | Melamine faced chipboard (MFC) | | | 142 | – |
| | Laminate | SF1-① | | 295 | – |
| | Fenix NTM® | | | 344 | – |
| Working shelf SF2 (available for high panels only), working shelf, in table top finish | None | | | | • |
| | Melamine faced chipboard (MFC) | | | – | 142 |
| | Laminate | SF2-① | | – | 295 |
| | Fenix NTM® | | | – | 344 |
| Media (sofas, location A/B) | None | | | | • |
| | A – 1 × PIP 1 × power socket, cable length 3000 mm B – 1 × PIP 1 × double USB charger (type A + C), cable length 3000 mm | | A-YKU1/B-YKU2-⑧ | | 450 |
| Base finish | Powder-coated steel | Jet black, RAL 9005 | BC-BK | | • |
| | Solid wood | Natural beech | | | 283 |
| | | Stained beech | BC-① | | 300 |
| | | Natural oak | | | 353 |
| Movable tablet (for solid wood base, table top in base colour) | None | | | | • |
| | Arm: Powder-coated steel, Jet black, RAL 9005 Table top: Solid wood | Natural beech | 1 szt. | MTF-①/BK-J1 | 153 |
| | | | 2 szt. | MTF-①/BK-J2 | 305 |
| | | Stained beech | 1 szt. | MTF-①/BK-J1 | 156 |
| | | | 2 szt. | MTF-①/BK-J2 | 314 |
| | | Natural oak | 1 szt. | MTF-①/BK-J1 | 163 |
| | | | 2 szt. | MTF-①/BK-J2 | 324 |
| | Foam | Flame retardant foam | | FFR2 | |
| Glides | Plastic glides | | GD | | • |
| | Nonskid glides | | GDN | | 20 |
| Wood and wood-based materials | Raw material – EU timber regulation | | EUTR | | • |
| Assembly | Partially Assembled, cardboard packaging (seats with assembled base and panels) | | PACK-A | | • |
| | Unassembled, cardboard packaging (seats with assembled base) | | PACK-UA | | ○ |
| Sample order | CREVA LANDSCAPE 2/TP/2 LS OS EX (SBC-CUZ63 P-H-LDS17 TF-KM BC-BK FFR2 GD EUTR PACK-A) | | | | |
| | CREVA LANDSCAPE 2/TP/2 LS OS EX (SBC-CUZ63 P-H-LDS17 TF-KM SF1-KM A-YKU1/B-YKU2-FR BC-BK MTF-SKNB/BK-J1 FFR2 GD EUTR PACK-A) | | | | |

① – Please specify wood colour code – see finishes

⑧ – Please specify media port standard: CH13, FR, GB, GE

• Available as standard (included in basic price)

○ Available as an option (included in basic price)

Price list

Creva Landscape 1/TP/TP/1 double-sided

Seats, low or high panels and cushions – upholstered, flame retardant foam.

Cushions connecting to panels with Velcro type fixing.

Upholstered table with square table top.

Base – powder-coated metal legs as standard or made of solid wood as an option, plastic glides in black colour.

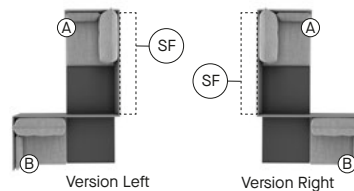

CREVA LANDSCAPE 1/TP/TP/1 LS DS

| | |
|--|--|
| Arrangement: W 1506 mm D 2236 mm H 873 / 1387 mm* SH 462 mm SH DIN 400 mm WM 763 mm WT 100,0 / 142,0 kg** | Table: W 720 mm D 720 mm H 385 mm |
|--|--|

Basic price (EUR)
according to upholstery price group

| | | | | |
|--|--------------------------------|--------------|-------|------|
| | Price group 2 | | | 3070 |
| | Price group 3 | | | 3189 |
| | Price group 4 | | | 3348 |
| | Price group 5 | | | 3422 |
| | Price group 6 | | | 4449 |
| Version | Left | V-L | | • |
| | Right | V-R | | ○ |
| Finish: seats, table carcass,, backrest cushions, side cushions | Upholstery | SBC-⑤ | | • |
| | | | 2 | 824 |
| Panels finish | Low panels, upholstered | Price group: | 3 | 924 |
| | | | 4 | 1040 |
| | | | 5 | 1186 |
| | | | 6 | 1542 |
| | | | P-L-⑤ | |
| | | | | |
| High panels, upholstered | Price group: | 2 | 1751 | |
| | | 3 | 1990 | |
| | | 4 | 2297 | |
| | | 5 | 2581 | |
| | | 6 | — | |
| | | P-H-⑤ | | |
| Table tops finish | Melamine faced chipboard (MFC) | | | • |
| | Laminate | TF-① | | 99 |
| | Fenix NTM® | | | 146 |

* – x/y cm - x: overall height with low panel / y: overall height with high panel

** – x/y kg - x: overall weight with low panel / y: overall weight with high panel

① – Please specify colour code of table top – [see finishes](#)

⑤ – Please specify upholstery colour code from selected price group – [see finishes](#)

Ⓐ – Media ports positioning

Ⓑ – Media ports positioning

Ⓢ – Working shelf positioning

• Available as standard (included in basic price)

○ Available as an option (included in basic price)

To complete product configuration select options on next pages →

PRICE GROUP 2: Boogie, Cura, Cura Loop, Home, Valencia, Xtreme

PRICE GROUP 3: Chili, Moulin-Fr, Silvertex, Step / Step Melange

PRICE GROUP 4: Blazer, Focus Royal, Main Line Flax, skai Parotega, Synergy

PRICE GROUP 5: Remix 3

PRICE GROUP 6: Nappa leather (not available for high panels)

| | | | | CREVA LANDSCAPE 1/TP/TP/1 LS DS |
|---|---|---------------------------------|--------------------------|---------------------------------|
| Working shelf (available for high panels only) | None | | | • |
| | Melamine faced chipboard (MFC) | | | 142 |
| | Laminate | SF- ^① | | 275 |
| | Fenix NTM® | | | 319 |
| Media (sofas, location A/B) | None | | | • |
| | A – 1 × PIP 1 × power socket, cable length 3000 mm B – 1 × PIP 1 × double USB charger (type A + C), cable length 3000 mm | A-YKU1/B- YKU2- ^⑧ | | 450 |
| Base finish | Powder-coated steel | Jet black, RAL 9005 | BC-BK | • |
| | Solid wood | Natural beech | | 377 |
| | | Stained beech | BC- ^① | 400 |
| | | Natural oak | | 471 |
| Movable tablet (for solid wood base, table top in base colour) | None | | | • |
| | Natural beech | 1 szt. | MTF- ^① /BK-J1 | 153 |
| | | 2 szt. | MTF- ^① /BK-J2 | 305 |
| | Stained beech | 1 szt. | MTF- ^① /BK-J1 | 156 |
| | | 2 szt. | MTF- ^① /BK-J2 | 314 |
| | Natural oak | 1 szt. | MTF- ^① /BK-J1 | 163 |
| | | 2 szt. | MTF- ^① /BK-J2 | 324 |
| | Foam | Flame retardant foam | | FFR2 |
| Glides | | Plastic glides | | GD |
| | Nonskid glides | | GDN | 34 |
| Wood and wood- based materials | Raw material – EU timber regulation | | EUTR | • |
| Assembly | Partially Assembled, cardboard packaging (seats with assembled base and panels) | | PACK-A | • |
| | Unassembled, cardboard packaging (seats with assembled base) | | PACK-UA | ○ |
| Sample order | CREVA LANDSCAPE 1/TP/TP/1 LS DS (V-L SBC-CUZ63 P-H-LDS17 TF-KM SF-KM A-YKU1/B-YKU2-FR BC-BK MTF-SKNB/BK-J1 FFR2 GD EUTR PACK-A) | | | |

^① – Please specify wood colour code – see finishes

^⑧ – Please specify media port standard: CH13, FR, GB, GE

• Available as standard (included in basic price)

○ Available as an option (included in basic price)

Price list

Creva Landscape 2/3 L-shape, one-sided, internal

Seats, low panels and cushions – upholstered, flame retardant foam.
Cushions fixed to panels with Velcro.
Base – powder-coated metal legs as standard or made of solid wood as an option, black plastic glides.



Wersja lewa

Wersja prawa

CREVA LANDSCAPE 2/3 LS OS INT

W 2236 mm
D 2236 mm
H 873 mm
SH 462 mm
SH DIN 400 mm
WT 122,0 kg

Basic price (EUR)
according to upholstery price group

| | | | | |
|--|---|----------------------|---------------------|------|
| | Price group 2 | | | 3700 |
| | Price group 3 | | | 3906 |
| | Price group 4 | | | 4228 |
| | Price group 5 | | | 4394 |
| | Price group 6 | | | 5713 |
| Version | Left | V-L | | • |
| | Right | V-R | | ○ |
| Finish: seats, table carcass,, backrest cushions, side cushions | Upholstery | SBC- ^⑤ | | • |
| | | | | |
| Panels finish | Low panels, upholstered | Price group: | 2 | 932 |
| | | | 3 | 1049 |
| | | | 4 P-L- ^⑤ | 1189 |
| | | | 5 | 1344 |
| | | | 6 | 1938 |
| Media (sofas, location A) | None | | | • |
| | A – 1 × PIP 1 × power socket, cable length 3000 mm | A-YKU1- ^⑧ | | 140 |
| | A – 1 × PIP 1 × double USB charger (type A + C), cable length 3000 mm | A-YKU2- ^⑧ | | 310 |
| Base finish | Powder-coated steel | Jet black, RAL 9005 | BC-BK | • |
| | | Natural beech | | 189 |
| | Solid wood | Stained beech | BC- ^① | 200 |
| | | Natural oak | | 236 |

^① – Please specify colour code of table top – see finishes

To complete product configuration select options on next pages →

^⑤ – Please specify upholstery colour code from selected price group – see finishes

^⑧ – Please specify media port standard: CH13, FR, GB, GE

[Ⓐ] – Media ports positioning

• Available as standard (included in basic price)

○ Available as an option (included in basic price)

PRICE GROUP 2: Boogie, Cura, Cura Loop, Home, Valencia, Xtreme

PRICE GROUP 3: Chili, Moulin-Fr, Silvertex, Step/Step Melange

PRICE GROUP 4: Blazer, Focus Royal, Main Line Flax, skai Parotega, Synergy

PRICE GROUP 5: Remix 3

PRICE GROUP 6: Nappa leather

| | | | CREVA LANDSCAPE 2/3 LS OS INT |
|--------------------------------------|---|---------|-------------------------------|
| Foam | Flame retardant foam | FFR2 | • |
| Glides | Plastic glides | GD | • |
| | Nonskid glides | GDN | 14 |
| Wood and wood-based materials | Raw material – EU timber regulation, from certified forests, FSC certificate – authorized companies | FSC | • |
| Assembly | Partially Assembled, cardboard packaging (seats with assembled base and panels) | PACK-A | • |
| | Unassembled, cardboard packaging (seats with assembled base) | PACK-UA | ○ |

Sample order CREVA LANDSCAPE 2/3 LS OS INT (V-L SBC-CUZ63 P-L-LDS17 BC-BK FFR2 GD FSC PACK-A)

- Available as standard (included in basic price)
- Available as an option (included in basic price)

Price list

Creva pouffe freestanding

Upholstered seat, flame retardant foam.

Base – powder-coated metal legs as standard or made of solid wood as an option, plastic glides in black colour.



| CREVA POUFFE 1U | CREVA POUFFE 2U | CREVA POUFFE 3U |
|--|---|---|
| W 720 mm D 720 mm H 462 mm SH 462 mm SH DIN 400 mm WT 13,9 kg | W 1450 mm D 720 mm H 462 mm SH 462 mm SH DIN 400 mm WT 21,9 kg | W 2180 mm D 720 mm H 462 mm SH 462 mm SH DIN 400 mm WT 29,4 kg |

Basic price (EUR) according to upholstery price group

| | Price group 2 | | | 560 | | 757 | 1045 | |
|---|---|-----------------------|---------------|----------|-----|------|------|--|
| | Price group 3 | | | 588 | | 800 | 1109 | |
| | Price group 4 | | | 626 | | 859 | 1202 | |
| | Price group 5 | | | 653 | | 903 | 1270 | |
| | Price group 6 | | | 849 | | 1174 | 1650 | |
| Seat finish | Upholstery | | SE-⑤ | • | • | • | | |
| | Powder-coated steel | Jet black, RAL 9005 | BC-BK | • | • | • | | |
| Base finish | | Natural beech | | 95 | 95 | 95 | | |
| | Solid wood | Stained beech | BC-① | 100 | 100 | 100 | | |
| | | Natural oak | | 118 | 118 | 118 | | |
| Media (pouffe, location A) | None | | | • | • | • | | |
| | A – 1 × PIP 1 × power socket 230V, cable length 3000 mm | | A-YKU1-⑧ | 140 | 140 | 140 | | |
| | A – 1 × PIP 1 × double USB charger (type A + C), cable length 3000 mm | | A-YKU2-⑧ | 310 | 310 | 310 | | |
| Movable tablet (for solid wood base, table top in base colour) | None | | | • | • | • | | |
| | Arm: Powder-coated steel, Jet black, RAL 9005 | Natural beech | | 153 | 153 | 153 | | |
| | | Table top: solid wood | Stained beech | MTF-①/BK | 156 | 156 | 156 | |
| | | | Natural oak | | 163 | 163 | 163 | |
| Foam | Flame retardant foam | | FFR2 | • | • | • | | |
| Glides | Plastic glides | | GD | • | • | • | | |
| | Nonskid glides | | GDN | 7 | 7 | 7 | | |
| Wood and wood-based materials | Raw material – EU timber regulation, from certified forests, FSC certificate – authorized companies | | FSC | • | • | • | | |
| Assembly | Assembled, cardboard packaging (seat with assembled base) | | PACK-ASM | • | • | • | | |

Sample order CREVA POUFFE 1U (SE-CUZ63 BC-BK A-YKU1-FR MTF-SKNB/BK FFR2 GD FSC PACK-ASM)

① – Please specify wood colour code – [see finishes](#)

⑤ – Please specify upholstery colour code from selected price group – [see finishes](#)

⑧ – Please specify media port standard: CH13, FR, GB, GE

Ⓐ – Media ports positioning

• Available as standard (included in basic price)

PRICE GROUP 2: Boogie, Cura, Cura Loop, Home, Valencia, Xtreme
 PRICE GROUP 3: Chili, Moulin-Fr, Silvertex, Step/Step Melange
 PRICE GROUP 4: Blazer, Focus Royal, Main Line Flax, skai Parotega, Synergy
 PRICE GROUP 5: Remix 3
 PRICE GROUP 6: Nappa leather

Creva pouffe for integration

Upholstered seat, flame retardant foam.

Base – powder-coated metal legs as standard or made of solid wood as an option, plastic glides in black colour.

The products includes an assembly set for integration of pouffes or pouffes with upholstered tables in arrangements.



| CREVA POUFFE 1U IN | CREVA POUFFE 2U IN | CREVA POUFFE 3U IN |
|--|---|---|
| W 720 mm D 720 mm H 462 mm SH 462 mm SH DIN 400 mm WT 15,8 / 17,7 kg* | W 1450 mm D 720 mm H 462 mm SH 462 mm SH DIN 400 mm WT 23,8 / 25,7 kg* | W 2180 mm D 720 mm H 462 mm SH 462 mm SH DIN 400 mm WT 31,3 / 33,2 kg* |

Basic price (EUR) according to upholstery price group

| | | | | | |
|---|---|------------------------------|-----|------|------|
| | Price group 2 | | 598 | 931 | 1293 |
| | Price group 3 | | 617 | 948 | 1303 |
| | Price group 4 | | 649 | 996 | 1368 |
| | Price group 5 | | 697 | 1076 | 1476 |
| | Price group 6 | | 905 | 1398 | 1919 |
| Integration | One-sided (on one side) | IN-OS | • | • | • |
| | Double-sided (on both sides) | IN-DS | 40 | 40 | 40 |
| Seat finish | Upholstery | SE-⑤ | • | • | • |
| | Powder-coated steel | Jet black, RAL 9005 BC-BK | • | • | • |
| Base finish | Solid wood | Natural beech | 95 | 95 | 95 |
| | | Stained beech | 100 | 100 | 100 |
| | | Natural oak | 118 | 118 | 118 |
| Media (pouffe, location A) | None | | • | • | • |
| | A – 1 × PIP 1 × power socket 230V, cable length 3000 mm | A-YKU1-⑧ | 140 | 140 | 140 |
| | A – 1 × PIP 1 × double USB charger (type A + C), cable length 3000 mm | A-YKU2-⑧ | 310 | 310 | 310 |
| Movable tablet (for solid wood base, table top in base colour) | None | | • | • | • |
| | Arm: Powder-coated steel, top: Jet black, RAL 9005 wood | Natural beech | 153 | 153 | 153 |
| | | Stained beech | 156 | 156 | 156 |
| | | Natural oak | 163 | 163 | 163 |
| Foam | Flame retardant foam | FFR2 | • | • | • |
| | Glides | Plastic glides | GD | • | • |
| Nonskid glides | | GDN | 7 | 7 | 7 |
| Wood and wood-based materials | Raw material – EU timber regulation, from certified forests, FSC certificate – authorized companies | FSC | • | • | • |
| Assembly | Assembled, cardboard packaging (seat with assembled base) | PACK-ASM | • | • | • |

Sample order CREVA POUFFE 1U IN (IN-DS SE-CUZ63 BC-BK A-YKU1-FR MTF-SKNB/BK FFR2 GD FSC PACK-ASM)

* – x / y kg - x: pouffe weight with assembly set for one-sided integration / y: pouffe weight with assembly set for double-sided integration

① – Please specify wood colour code – see finishes

⑤ – Please specify upholstery colour code from selected price group – see finishes

⑧ – Please specify media port standard: CH13, FR, GB, GE

Ⓐ – Media ports positioning

• Available as standard (included in basic price)

PRICE GROUP 2: Boogie, Cura, Cura Loop, Home, Valencia, Xtreme
 PRICE GROUP 3: Chili, Moulin-Fr, Silvertex, Step/Step Melange
 PRICE GROUP 4: Blazer, Focus Royal, Main Line Flax, skai Parotega, Synergy
 PRICE GROUP 5: Remix 3
 PRICE GROUP 6: Nappa leather

Price list

Creva upholstered table freestanding

Square table top, upholstered carcass, flame retardant foam.
Base – powder-coated metal legs as standard or made of solid wood as an option, plastic glides in black colour.



CREVA TABLE UPH

W 720 mm
D 720 mm
H 385 mm
WT 21,9 kg

Basic price (EUR)
according to upholstery price group

| | | | | |
|--------------------------------------|---|--------------------------------|------------|-----|
| | Price group 2 | | | 499 |
| | Price group 3 | | | 514 |
| | Price group 4 | | | 536 |
| | Price group 5 | | | 552 |
| | Price group 6 | | | 717 |
| Carcass and table top finish | Carcass: | Upholstery | | • |
| | | Melamine faced chipboard (MFC) | | |
| | Table top: | Laminate | TF-(5)(1) | 50 |
| | | Fenix NTM® | | 73 |
| Base finish | Powder-coated steel | Jet black, RAL 9005 | BC-BK | • |
| | Solid wood | Natural beech | | 95 |
| | | Stained beech | BC-(1) | 100 |
| | | Natural oak | | 118 |
| Media (table, location A) | None | | | • |
| | A – 1 × PIP 1 × power socket, cable length 3000 mm | | A-YKU1-(8) | 140 |
| | A – 1 × PIP 1 × double USB charger (type A + C), cable length 3000 mm | | A-YKU2-(8) | 310 |
| Foam | Flame retardant foam | | FFR2 | • |
| Glides | Plastic glides, black colour | | GD | • |
| | Nonskid glides | | GDN | 7 |
| Wood and wood-based materials | Raw material – EU timber regulation | | EUTR | • |
| Assembly | Assembled, cardboard packaging | | PACK-ASM | • |

Sample order CREVA TABLE UPH (TF-CUZ63/KM BC-BK A-YKU1-FR FFR2 GD EUTR PACK-ASM)

(1) – Please specify wood colour code – see finishes

(5) – Please specify upholstery colour code from selected price group – see finishes

(8) – Please specify media port standard: CH13, FR, GB, GE

(A) – Media ports positioning

• Available as standard (included in basic price)

PRICE GROUP 2: Boogie, Cura, Cura Loop, Home, Valencia, Xtreme
PRICE GROUP 3: Chili, Moulin-Fr, Silvertex, Step/Step Melange
PRICE GROUP 4: Blazer, Focus Royal, Main Line Flax, skai Parotega, Synergy
PRICE GROUP 5: Remix 3
PRICE GROUP 6: Nappa leather

Creva upholstered table for integration

Square table top, upholstered carcass, flame retardant foam.
 Base – powder-coated metal legs as standard or made of solid wood as an option,
 plastic glides in black colour.
 The products includes an assembly set for integration of upholstered tables or
 pouffes with upholstered tables in arrangements.

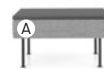

CREVA TABLE UPH IN

W 720 mm
 D 720 mm
 H 385 mm
 WT 23,8 / 25,7 kg*

Basic price (EUR)
 according to upholstery price group

| | | | | |
|--------------------------------------|---|--------------------------------|------------|-----|
| | Price group 2 | | | 535 |
| | Price group 3 | | | 551 |
| | Price group 4 | | | 574 |
| | Price group 5 | | | 589 |
| | Price group 6 | | | 766 |
| Integration | One-sided (on one side) | IN-OS | | • |
| | Double-sided (on both sides) | IN-DS | | 40 |
| Carcass and table top finish | Carcass: | Upholstery | | • |
| | | Melamine faced chipboard (MFC) | | |
| | Table top: | Laminate | TF-(5)/(1) | 50 |
| | | Fenix NTM® | | 73 |
| Base finish | Powder-coated steel | Jet black, RAL 9005 | BC-BK | • |
| | | Natural beech | | 95 |
| | Solid wood | Stained beech | BC-(1) | 100 |
| | | Natural oak | | 118 |
| Media (table, location A) | None | | | • |
| | A – 1 × PIP 1 × power socket, cable length 3000 mm | | A-YKU1-(8) | 140 |
| | A – 1 × PIP 1 × double USB charger (type A + C), cable length 3000 mm | | A-YKU2-(8) | 310 |
| Foam | Flame retardant foam | FFR2 | | • |
| Glides | Plastic glides, black colour | GD | | • |
| | Nonskid glides | GDN | | 7 |
| Wood and wood-based materials | Raw material – EU timber regulation | EUTR | | • |
| Assembly | Assembled, cardboard packaging | PACK-ASM | | • |

Sample order CREVA TABLE UPH IN (IN-DS TF-CUZ63/KM BC-BK A-YKU1-FR FFR2 GD EUTR PACK-ASM)

* – x / y kg - x: table weight with assembly set for one-sided integration / y: table weight with assembly set for double-sided integration

- (1) – Please specify wood colour code – [see finishes](#)
- (5) – Please specify upholstery colour code from selected price group – [see finishes](#)
- (8) – Please specify media port standard: CH13, FR, GB, GE
- (A) – Media ports positioning
- Available as standard (included in basic price)

PRICE GROUP 2: Boogie, Cura, Cura Loop, Home, Valencia, Xtreme
 PRICE GROUP 3: Chili, Moulin-Fr, Silvertex, Step/Step Melange
 PRICE GROUP 4: Blazer, Focus Royal, Main Line Flax, skai Parotega, Synergy
 PRICE GROUP 5: Remix 3
 PRICE GROUP 6: Nappa leather

Price list

Creva movable tablet

Round table top made of solid wood.
Base – powder-coated metal tablet arm.



CREVA TABLET 1

DI 300 mm
H 557 mm
WT 3,1 kg

Base price (EUR)

153

| Finish | Arm: Powder-coated steel, Jet black, RAL 9005 | Table top: Solid wood | | Base price (EUR) |
|--------------------------------------|---|-----------------------|----------------------------|------------------|
| | | | Natural beech | • |
| | | | Stained beech ^① | 7 |
| | | | Natural oak | 10 |
| Wood and wood-based materials | Raw material – EU timber regulation, from certified forests, FSC certificate – authorized companies | | FSC | • |

Sample order CREVA TABLET 1 (SKNB/FSC)

- ① – Please specify wood colour code – [see finishes](#)
- Available as standard (included in basic price)

Floor fixing (type 6)

Floor fixing element.

Screwed – dedicated to nonskid glides (set of 2 pieces, screws not included).

1 assembly set for:

- sofas, pouffes, upholstered tables,
- Landscape Cube arrangements,
- Landscape linear one-sided arrangements (1/TP/1),
- Landscape linear double-sided arrangements (2/1, 1/TP/TP/1, 1/T/1).

2 assembly sets for:

- American Diner units,
- Landscape linear one-sided arrangements (2/T/2, 2/T/1),
- Landscape linear double-sided arrangements (2/T/2),
- Landscape L-shape arrangements (2/TP/2 one-sided internal, 2/TP/2 one-sided external, 1/TP/TP/1 double-sided).

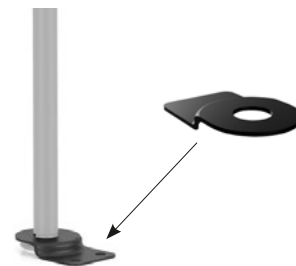

BENCH ACCESSORY FF 6

Base price (EUR)

56

Floor fixing (type 5)

Floor fixing element.

Glued – dedicated to plastic glides (set of 4 pieces).

1 assembly set for:

- sofas, pouffes and upholstered tables.

2 assembly sets for:

- American Diner units,
- Landscape Cube arrangements,
- Landscape linear double-sided arrangements (2/1).

3 assembly sets for:

- Landscape linear one-sided arrangements (2/T/2, 2/T/1, 1/TP/1),
- Landscape linear double-sided arrangements (2/T/2, 1/T/1),
- Landscape L-shape arrangements (2/TP/2 one-sided internal, 2/TP/2 one-sided external),

4 assembly sets for:

- Landscape linear double-sided arrangements (1/TP/TP/1),
- Landscape L-shape arrangements (1/TP/TP/1 double-sided).

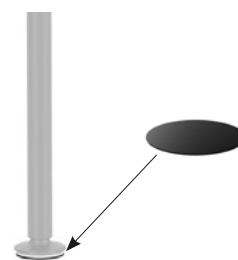

BENCH ACCESSORY FF 5

Base price (EUR)

9

Finishes

Wood

Natural



SKNB
Natural
Beech



SKNO
Natural Oak

Stained



2.0CB
Acacia



SK40
Oak



2.0CC
Walnut

Melamina



CC
Black



MS
Slate



MP
Platinum



MB
White Grey



NK
Cashmere



BA
Truffle Grey



ST
Smoke Blue

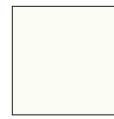

BI
White

Laminate



DD
Black



GW
Slate



BW
Platinum

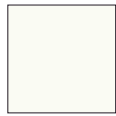

CA
White

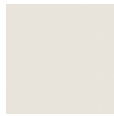

FN
White Grey

Fenix NTM®



KJ
Nero Ingo



KN
Grigio
Bromo



KM
Grigio
Antrim



KP
Rosso Jaipur



KR
Verde
Comodoro



KO
Blu Fes

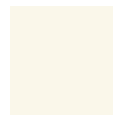

KS
Bianco Kos

Metal



RAL 9005
Jet Black
BK

General notes

All specified dimensions are approximate and they can vary depending on the selected product configuration. Subject to minor modifications or differences for reasons of design improvements or for technical reasons, we reserve the right to implement design changes to products.

- W = width
- D = depth
- H = height
- DI = diameter
- SH = seat height
- SH DIN* = seat height measured acc. to DIN EN 1335-1

Leather upholstered product

Leather is a natural product.

Visible wrinkles, scares, or any other marks are not defects, therefore they are not covered by the warranty and are not subject to complaint.

In compliance with the highest quality standards

We take care of the highest quality of applied solutions, both at design stage as well as materials and components supplies, production, quality control and distribution of our products.

Only the products marked in this document are FSC® (FSC®-C120977).

Look for our FSC®-certified products.

Sale of products that meet the FSC® requirements is possible only by Nowy Styl Sp. z o.o., Nowy Styl Nederland B.V. and Kusch + Co GmbH.



The FSC certificate applies to responsible forest management and the entire flow of raw materials from the forest to the customer. Each stage of the chain is monitored in terms of social, ecological and economic performance. The product with the FSC label gives customers a guarantee that the wood used for the production of the product comes from sources managed in a sustainable manner.

Warranty

Manufacturer declares that the products shall be free from defects in material or workmanship. The warranty is given to the original purchaser only, for normal commercial usage.

Detailed terms of warranty and warranty periods are available at

<https://www.kusch.com/en/warranty>

* The seat height was determined acc. to DIN EN 1335-1, i.e. the seat height measured by means of a measuring device at the position of the ischial tuberosity (sitting bones) after having placed a load of 50 kg on the half width of the seat.

genaya price list 2026

Genaya

Project: brodbeck / koepp design

Sofa



GENAYA SOFA 2U 2B



GENAYA SOFA 3U 3B



GENAYA SOFA 3U 2B



GENAYA SOFA 4U 4B



GENAYA SOFA 4U 3B

Sofa with panels



GENAYA SOFA 3U 3B PN



GENAYA SOFA 3U 2B PN



GENAYA SOFA 4U 4B PN



GENAYA SOFA 4U 3B PN

Double-sided sofa with panel



GENAYA SOFA 2U/2U 4B PN

Pouffe



GENAYA POUFFE 2U



GENAYA POUFFE 3U

Genaya

Project: brodbeck / koepp design

Table top for integration of pouffes and sofas



GENAYA TABLE TOP RC 1



GENAYA TABLE TOP A90



GENAYA TABLE TOP A120

Table top for integration of double-sided sofas



GENAYA TABLE TOP RC 2

Sofa arrangement



GENAYA SOFA SET L-SHAPE 1 INT



GENAYA SOFA SET L-SHAPE 2 EX



GENAYA SOFA SET U-SHAPE 1 INT



GENAYA SOFA SET U-SHAPE 1 EX



GENAYA SOFA SET U-SHAPE 2 INT



GENAYA SOFA SET Z-SHAPE 1



GENAYA SOFA SET Z-SHAPE 2



GENAYA SOFA SET S-SHAPE 3



GENAYA SOFA SET S-SHAPE 4



GENAYA SOFA SET O-SHAPE 1



GENAYA SOFA SET O-SHAPE 2



GENAYA SOFA SET O-SHAPE 3



GENAYA SOFA SET O-SHAPE 5



GENAYA SOFA SET O-SHAPE 6

Pouffe arrangement



GENAYA POUFFE SET L-SHAPE 1



GENAYA POUFFE SET U-SHAPE 1



GENAYA POUFFE SET Z-SHAPE 1



GENAYA POUFFE SET S-SHAPE 2



GENAYA POUFFE SET Z-SHAPE 3



GENAYA POUFFE SET Z-SHAPE 4

Genaya

Project: brodbeck / koepp design

Sample arrangements

Genaya sofa with high panels

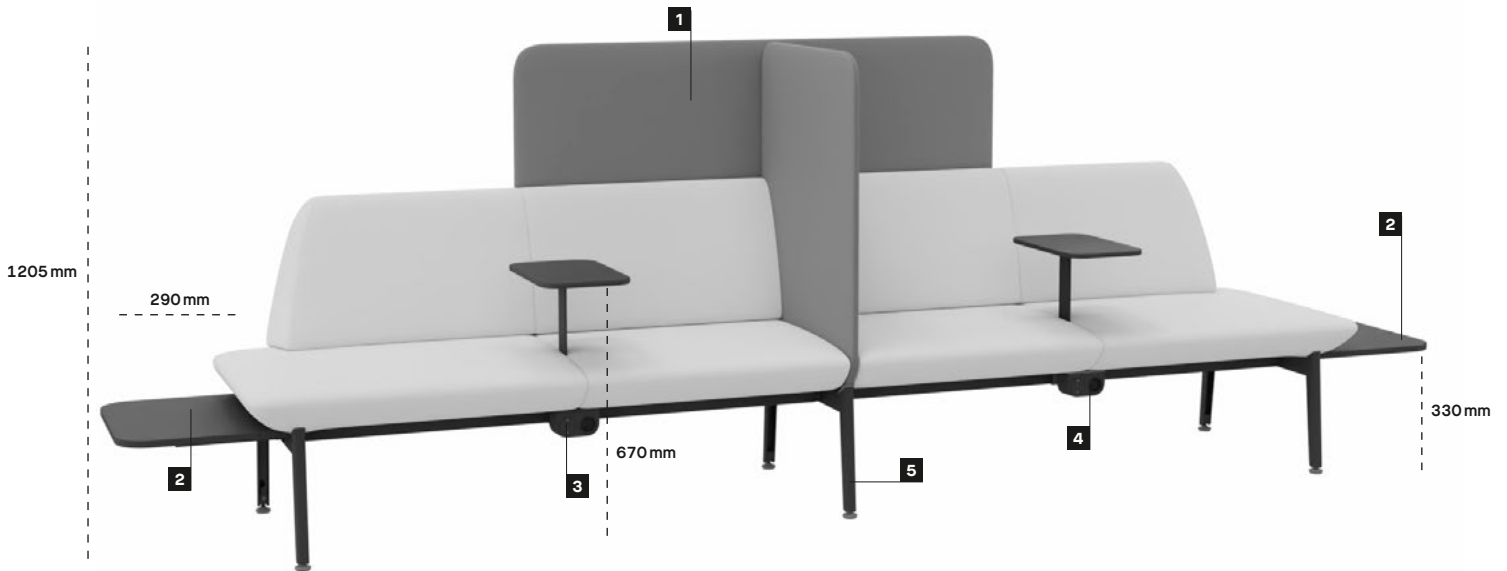

- 1 High panels
- 2 External table

- 3 Media port (position A)
- 4 Media port (position B)

- 5 Metal base

Genaya sofa with low panels

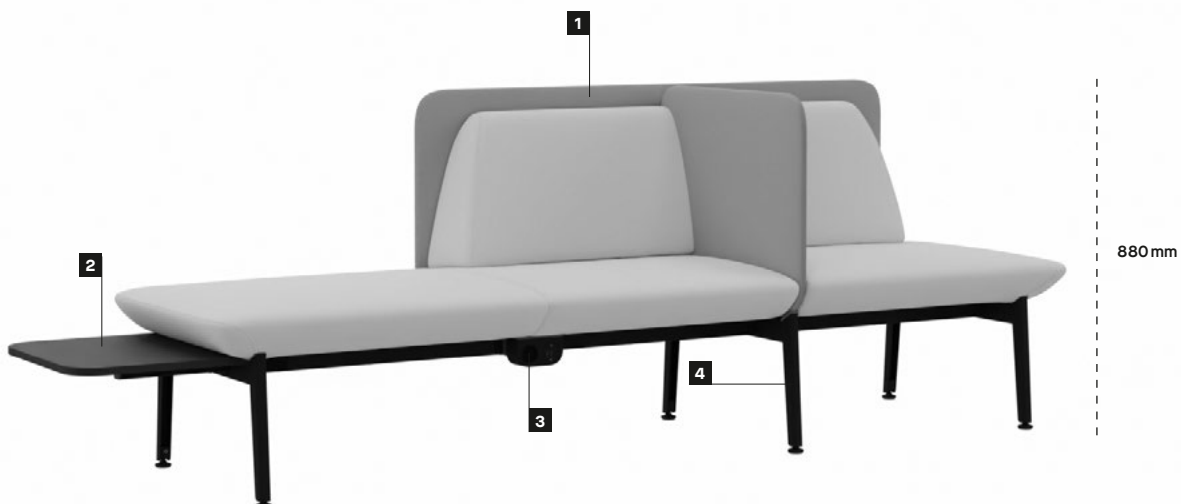

- 1 Low panels
- 2 External table

- 3 Media port (position A)
- 4 Metal base

Sample arrangements made up of sofas, pouffes and table tops

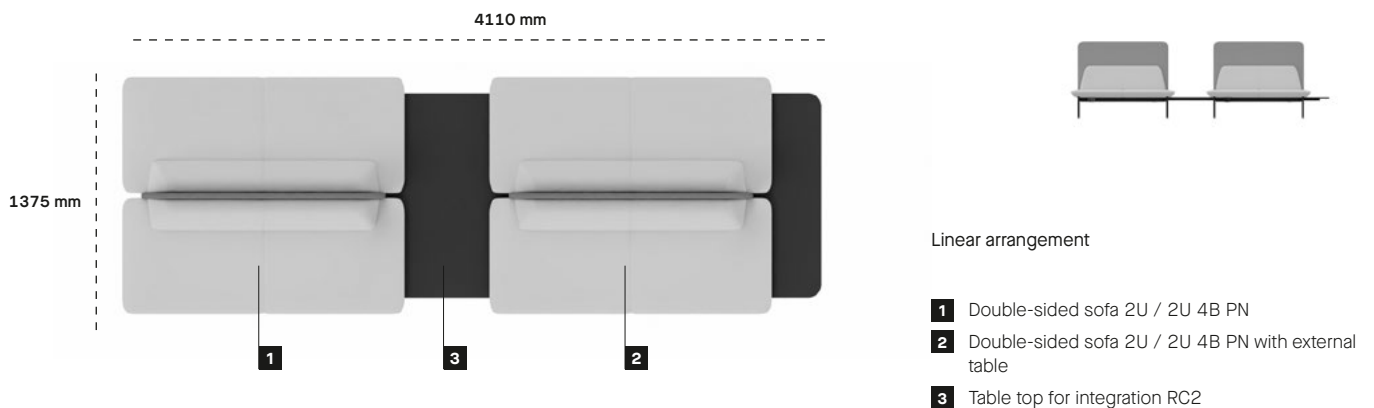
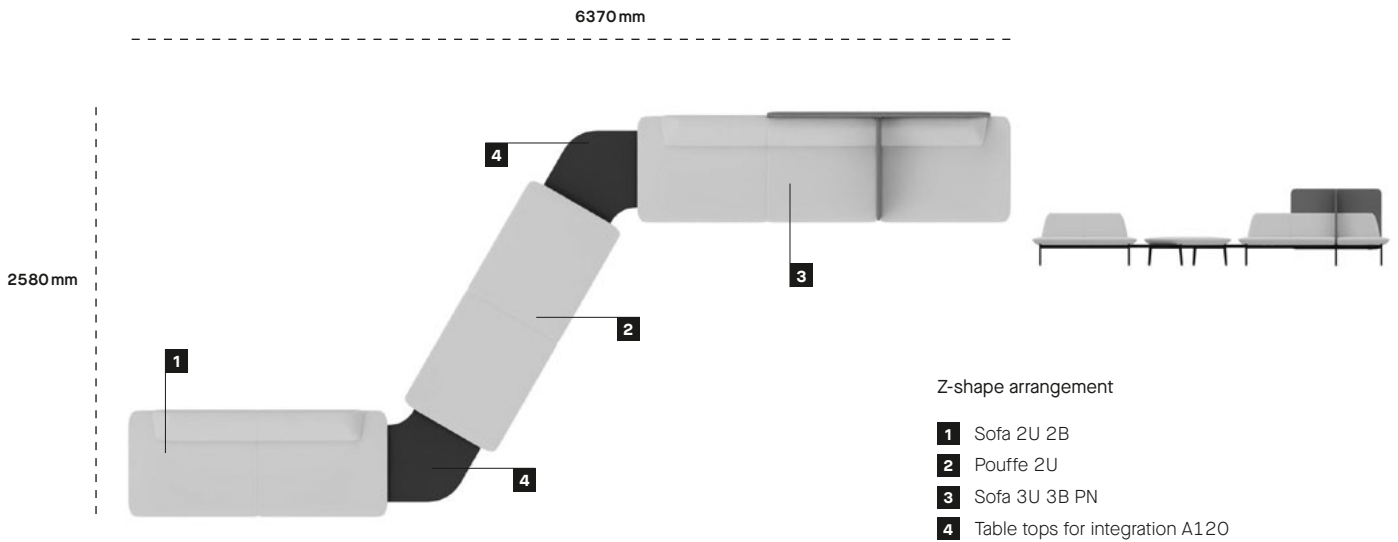
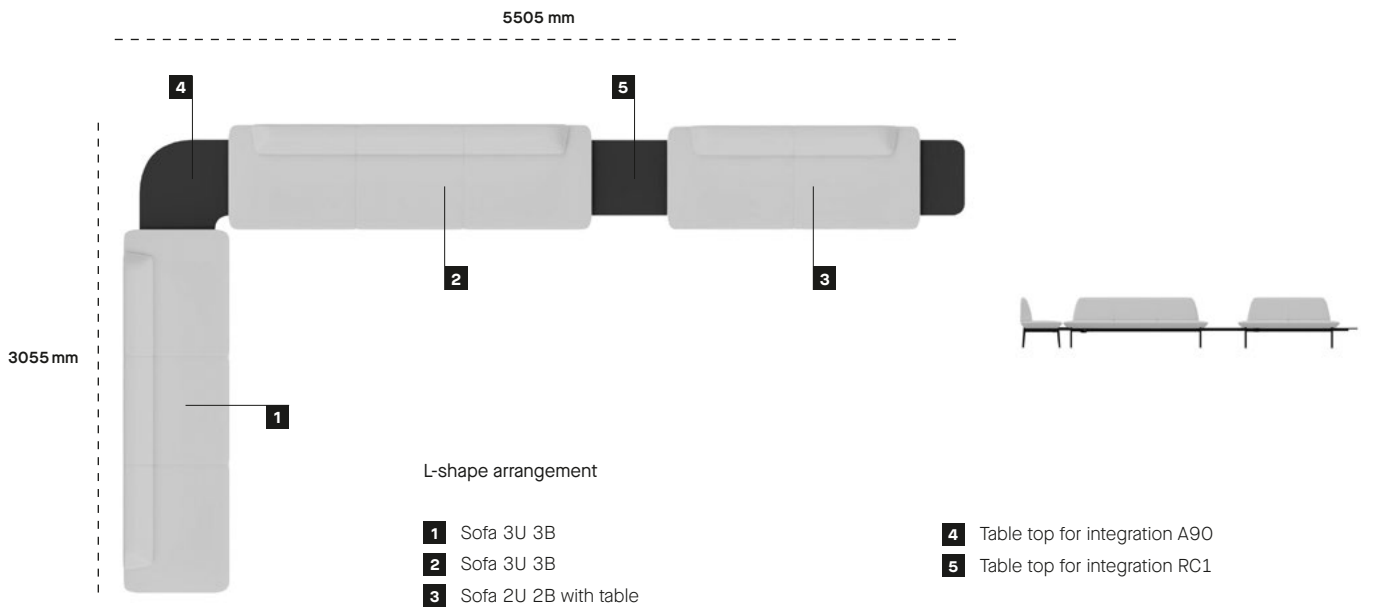

Price list

Genaya sofa

Seat and backrest – upholstered, flame retardant injected foam.
Base – frame and legs made of powder-coated steel.
Black plastic glides.

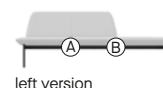

left version

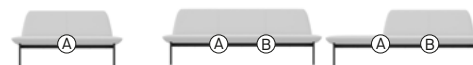

right version



| GENAYA SOFA 2U 2B | GENAYA SOFA 3U 3B | GENAYA SOFA 3U 2B |
|---|--|--|
| W 1660 mm D 670 mm H 815 mm SH 450 mm WT 52,1kg | W 2365 mm D 670 mm H 815 mm SH 450 mm WT 73,6 kg | W 2365 mm D 670 mm H 815 mm SH 450 mm WT 67,8 kg |

Basic price (EUR) according to upholstery price group

| | | | |
|---|------|------|------|
| 2 | 1305 | 1826 | 1612 |
| 3 | 1320 | 1840 | 1625 |
| 4 | 1376 | 1929 | 1695 |
| 5 | 1426 | 2003 | 1765 |
| 6 | 2085 | 2980 | 2570 |

| | | | | | | |
|---|--|---|---------------|-----|-----|-----|
| Version | Left | | V-L | | | • |
| | Right | | V-R | – | – | ◦ |
| Backrest finish | Upholstery | | BA-(5) | • | • | • |
| Seat finish | Upholstery | Upholstery type is the same as for backrest, colours may vary | SE-(5) | • | • | • |
| Base finish | Powder-coated steel | | BC-(3) | • | • | • |
| Media – position A | None | | | • | • | • |
| | Media port Phase 1 × power socket 1 × double USB charger USB (A + C) | Black colour | A-YJ001-(8)-B | 400 | 400 | 400 |
| Media – position B | None | | | – | • | • |
| | Media port Phase 1 × power socket 1 × double USB charger USB (A + C) | Black colour | B-YJ001-(8)-B | – | 400 | 400 |
| External table (all board elements in the same colour) | 1 pcs | None | | • | • | • |
| | | Melamine (MFC) | | 75 | 75 | 75 |
| | | Laminate | TF-(1)-J1 | 153 | 153 | 153 |
| | | Fenix NTM® | | 166 | 166 | 166 |
| | 2 pcs | Compact laminat | | 185 | 185 | 185 |
| | | Melamine (MFC) | | 150 | 150 | 150 |
| | | Laminate | TF-(1)-J2 | 306 | 306 | 306 |
| Fenix NTM® | 332 | 332 | | 332 | | |
| Compact laminat | | 370 | 370 | 370 | | |

(1) – Please specify table top colour code – [see finishes](#)

(3) – Please specify metal colour code – [see finishes](#)

(5) – Please specify upholstery colour code from selected price group – [see finishes](#)

(8) – Please specify media port standard: CH13, FR, GB, GE

• Available as standard (included in basic price)

◦ Available as an option (included in basic price)

PRICE GROUP 2: Cura, Cura Loop, Valencia, Xtreme

PRICE GROUP 3: Chili, Moulin-Fr, Silvertex, Step/Step Melange

PRICE GROUP 4: Blazer, Main Line Flax, Oceanic, skai Parotega, Synergy

PRICE GROUP 5: Remix 3

PRICE GROUP 6: Nappa Leather, Arona Leather

| | | | | GENAYA SOFA 2U 2B | GENAYA SOFA 3U 3B | GENAYA SOFA 3U 2B |
|--|---|--|-----------|----------------------|----------------------|----------------------|
| Tablet – position A (all board elements in the same colour) | None | | | • | • | • |
| | Melamine (MFC) | A-T- ^① | | 75 | 75 | 75 |
| | Laminate | | | 160 | 160 | 160 |
| | Fenix NTM® | | | 185 | 185 | 185 |
| | Compact laminat | | | 195 | 195 | 195 |
| Tablet – position B (all board elements in the same colour) | None | | | • | • | • |
| | Melamine (MFC) | B-T- ^① | | – | 75 | 75 |
| | Laminate | | | – | 160 | 160 |
| | Fenix NTM® | | | – | 185 | 185 |
| | Compact laminat | | | – | 195 | 195 |
| Glides | Plastic glides | GD | | • | • | • |
| | Nonskid glides | GDN | | 7 | 7 | 7 |
| | Glides with screwed floor fixing | GDS | | 45 | 45 | 45 |
| | Glides with glued floor fixing | GDG | | 10 | 10 | 10 |
| Foam | Flame retardant | FFR2 | | • | • | • |
| | Flame retardant with fireproof fabric | FFRF | | 190 | 285 | 250 |
| Wood and wood- based materials | Raw material – EU timber regulation, from certified forests, FSC certificate – authorized companies | For models without board elements | FSC | • | • | • |
| | Raw material – EU Timber regulation | For models with board elements (Melamine, Lami- nate, Fenix) | EUTR | ◦ | ◦ | ◦ |
| | Raw material – EU timber regulation, from certified forests, FSC certificate – authorized companies | For models with board ele- ments (Compact Laminat) | FSCMIX | ◦ | ◦ | ◦ |
| Assembly | Unassembled, cardboard packaging | | PACK-UA | • | • | • |
| | Partially assembled, no packaging | For models with external tables | PACK-ABDF | ◦ | ◦ | ◦ |
| | Assembled, no packaging | For models without external tables | PACK-BDF | ◦ | ◦ | ◦ |

Sample order GENAYA SOFA 2U 2B (BA-VL4001 SE-VL4001 BC-BL GD FFR2 FSC PACK-UA)

^① – Please specify table top colour code– [see finishes](#)

- Available as standard (included in basic price)
- Available as an option (included in basic price)

Price list

Genaya sofa

Seat and backrest – upholstered, flame retardant injected foam.
Base – frame and legs made of powder-coated steel.
Black plastic glides.



left version



right version



GENAYA SOFA 4U 4B

W 3070 mm
D 670 mm
H 815 mm
SH 450 mm
WT 98,9 kg

GENAYA SOFA 4U 3B

W 3070 mm
D 670 mm
H 815 mm
SH 450 mm
WT 93,1 kg

Basic price (EUR) according to upholstery price group

| | GENAYA SOFA 4U 4B | GENAYA SOFA 4U 3B |
|---|-------------------|-------------------|
| 2 | 2412 | 2198 |
| 3 | 2428 | 2215 |
| 4 | 2548 | 2314 |
| 5 | 2645 | 2407 |
| 6 | 3960 | 3555 |

| Version | Left | V-L | | |
|---|--|---|---------------|-----|
| | Right | V-R | | ◦ |
| Backrest finish | Upholstery | BA-(5) | • | • |
| Seat finish | Upholstery | Upholstery type is the same as for backrest, colours may vary | SE-(5) | • |
| Base finish | Powder-coated steel | BC-(3) | • | • |
| Media – position A | None | | • | • |
| | Media port Phase 1 × power socket 1 × double USB charger USB (A + C) | Black colour | A-YJ001-(8)-B | 400 |
| Media – position B | None | | • | • |
| | Media port Phase 1 × power socket 1 × double USB charger USB (A + C) | Black colour | B-YJ001-(8)-B | 400 |
| External table (all board elements in the same colour) | None | | • | • |
| | 1 pcs | Melamine (MFC) | | 75 |
| | | Laminate | TF-(1)-J1 | 153 |
| | | Fenix NTM® | | 166 |
| | | Compact laminat | | 185 |
| | 2 pcs | Melamine (MFC) | | 150 |
| | | Laminate | TF-(1)-J2 | 306 |
| | | Fenix NTM® | | 332 |
| | | Compact laminat | | 370 |

(1) – Please specify table top colour code – [see finishes](#)

(3) – Please specify metal colour code – [see finishes](#)

(5) – Please specify upholstery colour code from selected price group – [see finishes](#)

(8) – Please specify media port standard: CH13, FR, GB, GE

• Available as standard (included in basic price)

◦ Available as an option (included in basic price)

| | | | | GENAYA SOFA 4U 4B | GENAYA SOFA 4U 3B |
|--|---|--|-----------|-------------------|-------------------|
| Tablet – position A (all board elements in the same colour) | None | | | • | • |
| | Melamine (MFC) | | | 75 | 75 |
| | Laminate | A-T-① | | 160 | 160 |
| | Fenix NTM® | | | 185 | 185 |
| | Compact laminat | | | 195 | 195 |
| Tablet – position B (all board elements in the same colour) | None | | | • | • |
| | Melamine (MFC) | | | 75 | 75 |
| | Laminate | B-T-① | | 160 | 160 |
| | Fenix NTM® | | | 185 | 185 |
| | Compact laminat | | | 195 | 195 |
| Glides | Plastic glides | GD | | • | • |
| | Nonskid glides | GDN | | 7 | 7 |
| | Glides with screwed floor fixing | GDS | | 45 | 45 |
| | Glides with glued floor fixing | GDG | | 10 | 10 |
| Foam | Flame retardant | FFR2 | | • | • |
| | Flame retardant with fireproof fabric | FFRF | | 380 | 345 |
| Wood and wood-based materials | Raw material – EU timber regulation, from certified forests, FSC certificate – authorized companies | For models without board elements | FSC | • | • |
| | Raw material – EU Timber regulation | For models with board elements (Melamine, Laminate, Fenix) | EUTR | ○ | ○ |
| | Raw material – EU timber regulation, from certified forests, FSC certificate – authorized companies | For models with board elements (Compact Laminate) | FSCMIX | ○ | ○ |
| Assembly | Unassembled, cardboard packaging | | PACK-UA | • | • |
| | Partially assembled, no packaging | For models with external tables | PACK-ABDF | ○ | ○ |
| | Assembled, no packaging | For models without external tables | PACK-BDF | ○ | ○ |
| Sample order | GENAYA SOFA 4U 3B (V-R BA-VL4001 SE-VL4001 BC-BL GD FFR2 FSC PACK-UA) | | | | |

① – Please specify table top colour code– [see finishes](#)

- Available as standard (included in basic price)
- Available as an option (included in basic price)

Price list

Genaya sofa with panels

Seat and backrest – upholstered, flame retardant injected foam.
 Panels – upholstered, flame retardant cut foam.
 Base – frame and legs made of powder-coated steel.
 Black plastic glides.

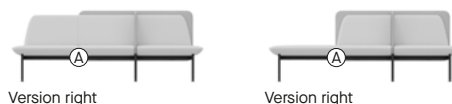
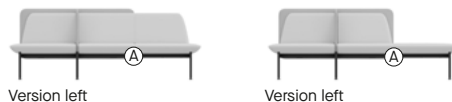

| GENAYA SOFA 3U 3B PN | GENAYA SOFA 3U 2B PN |
|--|---|
| W 2395 mm D 705 mm H 880 / 1205 mm* SH 450 mm WT 97,7 / 104,2 kg** | W 2395 mm D 705 mm H 880 / 1205 mm* SH 450 mm WT 91,9 / 98,4 kg** |

Basic price (EUR) according to upholstery price group

| | GENAYA SOFA 3U 3B PN | GENAYA SOFA 3U 2B PN |
|---|----------------------|----------------------|
| 2 | 1826 | 1612 |
| 3 | 1840 | 1625 |
| 4 | 1929 | 1695 |
| 5 | 2003 | 1765 |
| 6 | 2980 | 2570 |

| Version | Left | V-L | | | |
|--|--|--------------|-------------|------|------|
| | Right | V-R | – | • | |
| Backrest finish | Upholstery | BA-⑤ | • | • | |
| Seat finish | Upholstery | SE-⑤ | • | • | |
| Finishes for panels (upholstery type and colour may be different than for backrest and seat) | Low panels, upholstered | Price group: | 2 | 427 | 427 |
| | | | 3 | 435 | 435 |
| | | | 4 | 466 | 466 |
| | | | 5 | 500 | 500 |
| | | | 6 | 965 | 965 |
| | | | P-L-⑤ | | |
| | High panels, upholstered | Price group: | 2 | 561 | 561 |
| | | | 3 | 570 | 570 |
| | | | 4 | 638 | 638 |
| | | | 5 | 702 | 702 |
| | | | 6 | 1365 | 1365 |
| | | | P-H-⑤ | | |
| Base finish | Powder-coated steel | BC-③ | • | • | |
| | None | | • | • | |
| Media – position A | Media port Phase 1 × power socket 1 × double USB charger USB (A + C) | Black colour | A-YJ001-⑧-B | 400 | 400 |

* – x/y mm – x: overall height with low panel/y: overall height with high panel

** – x/y kg – x: overall weight with low panel/y: overall weight with high panel

③ – Please specify metal colour code – see finishes

⑤ – Please specify upholstery colour code from selected price group – see finishes

⑧ – Please specify media port standard: CH13, FR, GB, GE

• Available as standard (included in basic price)

○ Available as an option (included in basic price)

PRICE GROUP 2: Cura, Cura Loop, Valencia, Xtreme
 PRICE GROUP 3: Chili, Moulin-Fr, Silvertex, Step/Step Melange
 PRICE GROUP 4: Blazer, Main Line Flax, Oceanic, skai Parotega, Synergy
 PRICE GROUP 5: Remix 3
 PRICE GROUP 6: Nappa Leather, Arona Leather

| | | | | GENAYA SOFA 3U 3B PN | GENAYA SOFA 3U 2B PN |
|--|---|--|-----------|----------------------|----------------------|
| External table (all board elements in the same colour) | None | | | • | • |
| | 1 pcs | Melamine (MFC) | TF-①-J1 | 75 | 75 |
| | | Laminate | | 153 | 153 |
| | | Fenix NTM® | | 166 | 166 |
| | | Compact laminat | | 185 | 185 |
| | 2 pcs | Melamine (MFC) | TF-①-J2 | 150 | 150 |
| | | Laminate | | 306 | 306 |
| | | Fenix NTM® | | 332 | 332 |
| Compact laminat | | 370 | | 370 | |
| Tablet – position A (all board elements in the same colour) | None | | | • | • |
| | Melamine (MFC) | A-T-① | 75 | 75 | |
| | Laminate | | 160 | 160 | |
| | Fenix NTM® | | 185 | 185 | |
| | Compact laminat | | 195 | 195 | |
| | | | | | |
| Glides | Plastic glides | GD | | • | • |
| | Nonskid glides | GDN | 7 | 7 | |
| | Glides with screwed floor fixing | GDS | 45 | 45 | |
| | Glides with glued floor fixing | GDG | 10 | 10 | |
| Foam | Flame retardant | FFR2 | | • | • |
| | Flame retardant with fireproof fabric | FFRF | 495 | 460 | |
| Wood and wood-based materials | Raw material – EU timber regulation, from certified forests, FSC certificate – authorized companies | For models without board elements | FSC | • | • |
| | Raw material – EU Timber regulation | For models with board elements (Melamine, Laminate, Fenix) | EUTR | ◦ | ◦ |
| | Raw material – EU timber regulation, from certified forests, FSC certificate – authorized companies | For models with board elements (Compact Laminate) | FSCMIX | ◦ | ◦ |
| Assembly | Unassembled, cardboard packaging | | PACK-UA | • | • |
| | Partially assembled, no packaging | For models with external tables | PACK-ABDF | ◦ | ◦ |
| | Assembled, no packaging | For models without external tables | PACK-BDF | ◦ | ◦ |

Sample order GENAYA SOFA 3U 3B PN (V-L BA-VL4001 SE-VL4001 P-L-VL4001 BC-BL GD FFR2 FSC PACK-UA)

① – Please specify table top colour code – [see finishes](#)

- Available as standard (included in basic price)
- Available as an option (included in basic price)

Price list

Genaya sofa with panels

Seat and backrest – upholstered, flame retardant injected foam.
 Panels – upholstered, flame retardant cut foam.
 Base – frame and legs made of powder-coated steel.
 Black plastic glides.

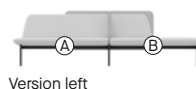

Version left



Version right



| GENAYA SOFA 4U 4B PN | GENAYA SOFA 4U 3B PN |
|---|---|
| W 3100 mm D 705 mm H 880/1205 mm* SH 450 mm WT 119,3/125,8 kg** | W 3100 mm D 705 mm H 880/1205 mm* SH 450 mm WT 113,5/120,0 kg** |

Basic price (EUR) according to upholstery price group

| | | |
|---|------|------|
| 2 | 2412 | 2198 |
| 3 | 2428 | 2215 |
| 4 | 2548 | 2314 |
| 5 | 2645 | 2407 |
| 6 | 3960 | 3555 |

| | | | | | |
|---|--------------------------|--------------|-------|------|------|
| Version | Left | V-L | | • | |
| | Right | V-R | – | ◦ | |
| Backrest finish | Upholstery | BA-⑤ | • | • | |
| Seat finish | Upholstery | SE-⑤ | • | • | |
| Finishes for panels (upholstery type and colour may be different than for backrest and seat) | Low panels, upholstered | Price group: | 2 | 427 | 427 |
| | | | 3 | 435 | 435 |
| | | | 4 | 466 | 466 |
| | | | 5 | 500 | 500 |
| | | | 6 | 965 | 965 |
| | | | P-L-⑤ | | |
| | High panels, upholstered | Price group: | 2 | 561 | 561 |
| | | | 3 | 570 | 570 |
| | | | 4 | 638 | 638 |
| | | | 5 | 702 | 702 |
| | | | 6 | 1365 | 1365 |
| | | | P-H-⑤ | | |
| Base finish | Powder-coated steel | BC-③ | • | • | |

* – x/y mm – x: overall height with low panel/y: overall height with high panel

** – x/y kg – x: overall weight with low panel/y: overall weight with high panel

③ – Please specify metal colour code – [see finishes](#)

⑤ – Please specify upholstery colour code from selected price group – [see finishes](#)

• Available as standard (included in basic price)

◦ Available as an option (included in basic price)

PRICE GROUP 2: Cura, Cura Loop, Valencia, Xtreme
 PRICE GROUP 3: Chili, Moulin-Fr, Silvertex, Step/Step Melange
 PRICE GROUP 4: Blazer, Main Line Flax, Oceanic, skai Parotega, Synergy
 PRICE GROUP 5: Remix 3
 PRICE GROUP 6: Nappa Leather, Arona Leather

| | | | | GENAYA SOFA 4U 4B PN | GENAYA SOFA 4U 3B PN |
|--|---|--|-------------|----------------------|----------------------|
| Media – position A | None | | | • | • |
| | Media port Phase 1 × power socket 1 × double USB charger USB (A + C) | Black colour | A-YJ001-⑧-B | 400 | 400 |
| Media – position B | None | | | • | • |
| | Media port Phase 1 × power socket 1 × double USB charger USB (A + C) | Black colour | B-YJ001-⑧-B | 400 | 400 |
| External table (all board elements in the same colour) | None | | | • | • |
| | 1 pcs | Melamine (MFC) | TF-①-J1 | 75 | 75 |
| | | Laminate | | 153 | 153 |
| | | Fenix NTM® | | 166 | 166 |
| | | Compact laminat | | 185 | 185 |
| | 2 pcs | Melamine (MFC) | TF-①-J2 | 150 | 150 |
| | | Laminate | | 306 | 306 |
| | | Fenix NTM® | | 332 | 332 |
| Compact laminat | | 370 | | 370 | |
| Tablet – position A (all board elements in the same colour) | None | | | • | • |
| | Melamine (MFC) | A-T-① | 75 | 75 | |
| | Laminate | | 160 | 160 | |
| | Fenix NTM® | | 185 | 185 | |
| | Compact laminat | | 195 | 195 | |
| | | | | | |
| Tablet – position B (all board elements in the same colour) | None | | | • | • |
| | Melamine (MFC) | B-T-① | 75 | 75 | |
| | Laminate | | 160 | 160 | |
| | Fenix NTM® | | 185 | 185 | |
| | Compact laminat | | 195 | 195 | |
| | | | | | |
| Glides | Plastic glides | GD | | • | • |
| | Nonskid glides | GDN | 7 | 7 | |
| | Glides with screwed floor fixing | GDS | 45 | 45 | |
| | Glides with glued floor fixing | GDG | 10 | 10 | |
| Foam | Flame retardant | FFR2 | | • | • |
| | Flame retardant with fireproof fabric | FFRF | 590 | 555 | |
| Wood and wood-based materials | Raw material – EU timber regulation, from certified forests, FSC certificate – authorized companies | For models without board elements | FSC | • | • |
| | Raw material – EU Timber regulation | For models with board elements (Melamine, Laminate, Fenix) | EUTR | ◦ | ◦ |
| | Raw material – EU timber regulation, from certified forests, FSC certificate – authorized companies | For models with board elements (Compact Laminate) | FSCMIX | ◦ | ◦ |
| Assembly | Unassembled, cardboard packaging | | PACK-UA | • | • |
| | Partially assembled, no packaging | For models with external tables | PACK-ABDF | ◦ | ◦ |
| | Assembled, no packaging | For models without external tables | PACK-BDF | ◦ | ◦ |
| Sample order | GENAYA SOFA 4U 3B PN (V-L BA-VL4001 SE-VL4001 P-H-VL4001 BC-BL GD FFR2 FSC PACK-UA) | | | | |

① – Please specify table top colour code– see finishes

⑧ – Please specify media port standard: CH13, FR, GB, GE

• Available as standard (included in basic price)

◦ Available as an option (included in basic price)

Price list

Genaya double-sided sofa with panel

Seats and backrests – upholstered, flame retardant injected foam.
 Panel – upholstered, flame retardant cut foam.
 Base – frame and legs made of powder-coated steel, black plastic glides.
 Integration into arrangements – with other double-sided sofas for integration using additional table tops.

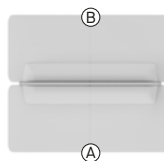

GENAYA SOFA 2U/2U 4B PN

W 1660 mm
 D 1375 mm
 H 880 / 1205 mm*
 SH 450 mm
 WT 113,6 / 118,6 kg**

Basic price (EUR) according to upholstery price group

| | |
|---|------|
| 2 | 2245 |
| 3 | 2262 |
| 4 | 2315 |
| 5 | 2365 |
| 6 | 3665 |

| | | | | | | | | | | | | |
|---|--------------------------|---|---------|---------------------------|--|--------------|---------------|---------------------------|--|--------------|---------------|-----|
| Finishes for backrests | Upholstery | | BA-(5) | • | | | | | | | | |
| Finishes for seats | Upholstery | Upholstery type is the same as for backrest, colours may vary | SE-(5) | • | | | | | | | | |
| Finishes for panels (upholstery type and colour may be different than for backrest and seat) | Low panels, upholstered | Price group: | 2 | 274 | | | | | | | | |
| | | | 3 | 282 | | | | | | | | |
| | | | 4 | 300 | | | | | | | | |
| | High panels, upholstered | Price group: | 5 | 368 | | | | | | | | |
| | | | 6 | 965 | | | | | | | | |
| | | | P-L-(5) | | | | | | | | | |
| Base finish | Powder-coated steel | | BC-(3) | • | | | | | | | | |
| | | | | • | | | | | | | | |
| | | | | Media – position A | Media port Phase 1 × power socket 1 × double USB charger USB (A + C) | Black colour | A-YJ001-(8)-B | 400 | | | | |
| | | | | | | | | • | | | | |
| | | | | | | | | Media – position B | Media port Phase 1 × power socket 1 × double USB charger USB (A + C) | Black colour | B-YJ001-(8)-B | 400 |
| | | | | | | | | | | | | • |

* – x/y mm – x: overall height with low panel/y: overall height with high panel

** – x/y kg – x: overall weight with low panel/y: overall weight with high panel

(3) – Please specify metal colour code – see finishes

(5) – Please specify upholstery colour code from selected price group – see finishes

(8) – Please specify media port standard: CH13, FR, GB, GE

• Available as standard (included in basic price)

PRICE GROUP 2: Cura, Cura Loop, Valencia, Xtreme
 PRICE GROUP 3: Chili, Moulin-Fr, Silvertex, Step/Step Melange
 PRICE GROUP 4: Blazer, Main Line Flax, Oceanic, skai Parotega, Synergy
 PRICE GROUP 5: Remix 3
 PRICE GROUP 6: Nappa Leather, Arona Leather

GENAYA SOFA 2U/2U 4B PN

| | | | | |
|--|---|--|-----------|-----|
| External table (all board elements in the same colour) | 1 pcs | None | | • |
| | | Melamine (MFC) | | 150 |
| | | Laminate | | 306 |
| | 2 pcs | Fenix NTM® | TF-①-J1 | 332 |
| | | Compact laminat | | 370 |
| | | Melamine (MFC) | | 300 |
| | | Laminate | | 612 |
| | | Fenix NTM® | TF-①-J2 | 664 |
| | | Compact laminat | | 740 |
| Tablet – position A (all board elements in the same colour) | None | | • | |
| | Melamine (MFC) | | 75 | |
| | Laminate | | 160 | |
| | Fenix NTM® | A-T-① | 185 | |
| | Compact laminat | | 195 | |
| Tablet – position B (all board elements in the same colour) | None | | • | |
| | Melamine (MFC) | | 75 | |
| | Laminate | | 160 | |
| | Fenix NTM® | B-T-① | 185 | |
| | Compact laminat | | 195 | |
| Glides | Plastic glides | GD | • | |
| | Nonskid glides | GDN | 7 | |
| | Glides with screwed floor fixing | GDS | 45 | |
| | Glides with glued floor fixing | GDG | 10 | |
| Foam | Flame retardant | FFR2 | • | |
| | Flame retardant with fireproof fabric | FFRF | 520 | |
| Wood and wood-based materials | Raw material – EU timber regulation, from certified forests, FSC certificate – authorized companies | For models without board elements | FSC | • |
| | Raw material – EU Timber regulation | For models with board elements (Melamine, Laminate, Fenix) | EUTR | ○ |
| | Raw material – EU timber regulation, from certified forests, FSC certificate – authorized companies | For models with board elements (Compact Laminate) | FSCMIX | ○ |
| Assembly | Unassembled, cardboard packaging | | PACK-UA | • |
| | Partially assembled, no packaging | For models with external tables | PACK-ABDF | ○ |
| | Assembled, no packaging | For models without external tables | PACK-BDF | ○ |

Sample order GENAYA SOFA 2U/2U 4B PN (BA-VL4001 SE-VL4001 BC-BL GD FFR2 FSC PACK-UA)

① – Please specify table top colour code– [see finishes](#)

- Available as standard (included in basic price)
- Available as an option (included in basic price)

Price list

Genaya pouffe

Seat – upholstered, flame retardant injected foam.
Base – frame and legs made of powder-coated steel.
Black plastic glides.



| GENAYA POUFFE 2U | GENAYA POUFFE 3U |
|--|--|
| W 1660 mm D 670 mm H 450 mm SH 450 mm WT 41,4 kg | W 2365 mm D 670 mm H 450 mm SH 450 mm WT 57,1 kg |

Basic price (EUR) according to upholstery price group

| Upholstery Price Group | GENAYA POUFFE 2U | GENAYA POUFFE 3U |
|------------------------|------------------|------------------|
| 2 | 846 | 1107 |
| 3 | 858 | 1120 |
| 4 | 886 | 1164 |
| 5 | 918 | 1210 |
| 6 | 1305 | 1785 |

| | | | | |
|---------------------------|--|-------------------------------|----------------|-----------|
| Seat finish | Upholstery | SE-(5) | • | • |
| Base finish | Powder-coated steel | BC-(3) | • | • |
| Media – position A | None | | • | • |
| | Media port Phase 1 × power socket 1 × double USB charger USB (A + C) | Black colour A-YJ001-(8)-B | 400 | 400 |
| | None | | – | • |
| Media – position B | Media port Phase 1 × power socket 1 × double USB charger USB (A + C) | Black colour B-YJ001-(8)-B | – | 400 |
| | None | | • | • |
| | External table (all board elements in the same colour) | 1 pcs | Melamine (MFC) | TF-(1)-J1 |
| Laminate | | | 153 | |
| Fenix NTM® | | | 166 | |
| Compact laminat | | | 185 | |
| 2 pcs | Melamine (MFC) | TF-(1)-J2 | 150 | |
| | Laminate | | 306 | |
| | Fenix NTM® | | 332 | |
| | Compact laminat | | 370 | |

① – Please specify table top colour code- see finishes

③ – Please specify metal colour code – see finishes

⑤ – Please specify upholstery colour code from selected price group – see finishes

⑧ – Please specify media port standard: CH13, FR, GB, GE

• Available as standard (included in basic price)

PRICE GROUP 2: Cura, Cura Loop, Valencia, Xtreme

PRICE GROUP 3: Chili, Moulin-Fr, Silvertex, Step/Step Melange

PRICE GROUP 4: Blazer, Main Line Flax, Oceanic, skai Parotega, Synergy

PRICE GROUP 5: Remix 3

PRICE GROUP 6: Nappa Leather, Arona Leather

| | | | | GENAYA POUFFE 2U | GENAYA POUFFE 3U |
|--|---|--|-----------|------------------|------------------|
| Tablet – position A (all board elements in the same colour) | None | | | • | • |
| | Melamine (MFC) | | | 75 | 75 |
| | Laminate | A-T-① | | 160 | 160 |
| | Fenix NTM® | | | 185 | 185 |
| | Compact laminat | | | 195 | 195 |
| Tablet – position B (all board elements in the same colour) | None | | | • | • |
| | Melamine (MFC) | | | | 75 |
| | Laminate | B-T-① | | – | 160 |
| | Fenix NTM® | | | | 185 |
| | Compact laminat | | | | 195 |
| Glides | Plastic glides | GD | | • | • |
| | Nonskid glides | GDN | | 7 | 7 |
| | Glides with screwed floor fixing | GDS | | 45 | 45 |
| | Glides with glued floor fixing | GDG | | 10 | 10 |
| Foam | Flame retardant | FFR2 | | • | • |
| | Flame retardant with fireproof fabric | FFRF | | 120 | 180 |
| Wood and wood-based materials | Raw material – EU timber regulation, from certified forests, FSC certificate – authorized companies | For models without board elements | FSC | • | • |
| | Raw material – EU Timber regulation | For models with board elements (Melamine, Laminate, Fenix) | EUTR | ○ | ○ |
| | Raw material – EU timber regulation, from certified forests, FSC certificate – authorized companies | For models with board elements (Compact Laminate) | FSCMIX | ○ | ○ |
| Assembly | Unassembled, cardboard packaging | | PACK-UA | • | • |
| | Partially assembled, no packaging | For models with external tables | PACK-ABDF | ○ | ○ |
| | Assembled, no packaging | For models without external tables | PACK-BDF | ○ | ○ |
| Sample order | GENAYA POUFFE 3U (BA-VL4001 SE-VL4001 BC-BL GD FFR2 FSC PACK-UA) | | | | |

① – Please specify table top colour code– [see finishes](#)

- Available as standard (included in basic price)
- Available as an option (included in basic price)

Price list

Genaya table top for of pouffes and sofas

Table top used to connect two sofas or pouffes for integration.
Table top – rectangular, 90 ° or 120 ° angular.
Frame – made of powder-coated steel.



| GENAYA TABLE TOP RC 1 | GENAYA TABLE TOP A90 | GENAYA TABLE TOP A120 |
|---------------------------------------|---|---|
| W 720/500 mm* D 490 mm WT 7,5kg | W 700/690 × 705/595 mm* D 700 mm WT 8,7 kg | W 770/565 × 495/385 mm* D 685 mm WT 7,6 kg |

Basic price (EUR) according to finishes for table tops

| | GENAYA TABLE TOP RC 1 | GENAYA TABLE TOP A90 | GENAYA TABLE TOP A120 |
|-----------------|-----------------------|----------------------|-----------------------|
| Melamine (MFC) | 115 | 160 | 155 |
| Laminate | 200 | 270 | 265 |
| Fenix NTM® | 240 | 315 | 305 |
| Compact laminat | 315 | 470 | 460 |

| | | | | | | |
|--------------------------------------|---|--|----------|---|---|---|
| Table top finish | Melamine (MFC) | | | | | |
| | Laminate | ① | • | • | • | |
| | Fenix NTM® | | | | | |
| | Compact laminat | | | | | |
| Finish for metal elements | Powder-coated steel | BC-③ | • | • | • | |
| | Raw material – EU Timber regulation | For models with board elements (Melamine, Laminate, Fenix) | EUTR | • | • | • |
| Wood and wood-based materials | Raw material – EU timber regulation, from certified forests, FSC certificate – authorized companies | For models with board elements (Compact Laminate) | FSCMIX | ○ | ○ | ○ |
| | Assembly | Assembled, cardboard packaging | PACK-ASM | • | • | • |
| Sample order | GENAYA TABLE TOP RC 1 (NJ BC-BI EUTR PACK-ASM) | | | | | |

* – x/y mm – x: table top overall width y: table top usable width after connection with two sofas/pouffes

① – Please specify table top colour code – [see finishes](#)

③ – Please specify metal colour code – [see finishes](#)

- Available as standard (included in basic price)
- Available as an option (included in basic price)

Genaya table top for double-sided sofas

Table top used to connect into an arrangement two double-sided sofas for integration.
Table top – rectangular. Frame – made of powder-coated steel.



GENAYA TABLE TOP RC 2

W 720/500 mm*
D 1180 mm
WT 15,5 kg

Basic price (EUR) according to finishes for table tops

| | |
|-----------------|-----|
| Melamine (MFC) | 210 |
| Laminate | 330 |
| Fenix NTM® | 415 |
| Compact laminat | 540 |

| | | | | |
|--------------------------------------|---|--|----------|---|
| Table top finish | Melamine (MFC) | | | |
| | Laminate | | | • |
| | Fenix NTM® | ① | | • |
| | Compact laminat | | | |
| Finish for metal elements | Powder-coated steel | BC-③ | | • |
| Wood and wood-based materials | Raw material – EU Timber regulation | For models with board elements (Melamine, Laminate, Fenix) | EUTR | • |
| | Raw material – EU timber regulation, from certified forests, FSC certificate – authorized companies | For models with board elements (Compact Laminate) | FSCMIX | ◦ |
| Assembly | Assembled, cardboard packaging | | PACK-ASM | • |
| Sample order | GENAYA TABLE TOP RC 2 (MB BC-WK EUTR PACK-ASM) | | | |

* – x/y mm – x: table top overall width y: table top usable width after connection with two sofas/pouffes

① – Please specify table top colour code – [see finishes](#)

③ – Please specify metal colour code – [see finishes](#)

• Available as standard (included in basic price)

◦ Available as an option (included in basic price)

Price list

Genaya sofa arrangement

Seat and backrest – upholstered, flame retardant injected foam.
Base – frame and legs made of powder-coated steel. Black plastic glides.

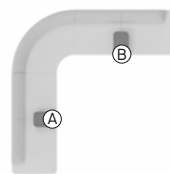

Genaya sofa arrangement L-SHAPE 1 internal

GENAYA SOFA SET L-SHAPE 1 INT

Arrangement surface: 2485 × 2485 mm
H 815 mm
SH 450 mm
WT 139,5 kg

Basic price (EUR) according to upholstery price group

| | |
|---|------|
| 2 | 3699 |
| 3 | 3784 |
| 4 | 3929 |
| 5 | 4095 |
| 6 | 5963 |



| | | | | |
|--|--|---|-------------|-----|
| Backrest finish | Upholstery | | BA-⑤ | • |
| Seat finish | Upholstery | Upholstery type is the same as for backrest, colours may vary | SE-⑤ | • |
| Base finish | Powder-coated steel | | BC-③ | • |
| Media – position A | None | | | • |
| | Media port Phase 1 × power socket 1 × double USB charger USB (A + C) | Black colour | A-YJ001-⑧-B | 400 |
| | None | | | • |
| Media – position B | None | | | • |
| | Media port Phase 1 × power socket 1 × double USB charger USB (A + C) | Black colour | B-YJ001-⑧-B | 400 |
| | None | | | • |
| External table (all board elements in the same colour) | 1 pcs Table width 290 mm | Melamine (MFC) | TF-①-J1 | 75 |
| | | Laminate | | 153 |
| | | Fenix NTM® | | 166 |
| | 2 pcs Table width 290 mm | Compact laminat | TF-①-J2 | 185 |
| | | Melamine (MFC) | | 150 |
| | | Laminate | | 306 |
| | | Fenix NTM® | | 332 |
| | Compact laminat | | 370 | |
| Tablet – position A (all board elements in the same colour) | None | | A-T-① | • |
| | Melamine (MFC) | | | 75 |
| | Laminate | | | 160 |
| | Fenix NTM® | | | 185 |
| | Compact laminat | | | 195 |

- ① – Please specify table top colour code- [see finishes](#)
- ③ – Please specify metal colour code - [see finishes](#)
- ⑤ – Please specify upholstery colour code from selected price group - [see finishes](#)
- ⑧ – Please specify media port standard: CH13, FR, GB, GE

• Available as standard (included in basic price)

PRICE GROUP 2: Cura, Cura Loop, Valencia, Xtreme
PRICE GROUP 3: Chili, Moulin-Fr, Silvertex, Step/Step Melange
PRICE GROUP 4: Blazer, Main Line Flax, Oceanic, skai Parotega, Synergy
PRICE GROUP 5: Remix 3
PRICE GROUP 6: Nappa Leather, Arona Leather

GENAYA SOFA SET L-SHAPE 1 INT

| | | | | |
|--|---|--|-----------|-----|
| Tablet – position B (all board elements in the same colour) | None | | | • |
| | Melamine (MFC) | | | 75 |
| | Laminate | B-T-① | | 160 |
| | Fenix NTM® | | | 185 |
| | Compact laminat | | | 195 |
| Glides | Plastic glides | GD | | • |
| | Nonskid glides | GDN | | 7 |
| | Glides with screwed floor fixing | GDS | | 45 |
| | Glides with glued floor fixing | GDG | | 10 |
| Foam | Flame retardant | FFR2 | | • |
| | Flame retardant with fireproof fabric | FFRF | | 555 |
| Wood and wood-based materials | Raw material – EU timber regulation, from certified forests, FSC certificate – authorized companies | For models without board elements | FSC | • |
| | Raw material – EU Timber regulation | For models with board elements (Melamine, Laminate, Fenix) | EUTR | ◦ |
| | Raw material – EU timber regulation, from certified forests, FSC certificate – authorized companies | For models with board elements (Compact Laminate) | FSCMIX | ◦ |
| Assembly | Unassembled, cardboard packaging | | PACK-UA | • |
| | Partially assembled, no packaging | | PACK-ABDF | ◦ |
| Sample order | GENAYA SOFA SET L-SHAPE 1 INT (BA-VL4001 SE-VL4001 BC-BL GD FFR2 FSC PACK-UA) | | | |

① – Please specify table top colour code– [see finishes](#)

- Available as standard (included in basic price)
- Available as an option (included in basic price)

Price list

Genaya sofa arrangement

Seat and backrest – upholstered, flame retardant injected foam.
Base – frame and legs made of powder-coated steel. Black plastic glides.

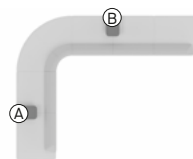

Genaya sofa arrangement L-SHAPE 2 external

GENAYA SOFA SET L-SHAPE 2 EX

Arrangement surface: 3190 × 2485 mm
H 815 mm
SH 450 mm
WT 153,0 kg

Basic price (EUR) according to upholstery price group

| | |
|---|------|
| 2 | 4072 |
| 3 | 4148 |
| 4 | 4322 |
| 5 | 4503 |
| 6 | 6614 |

| | | | | |
|---|--|---|-------------|-----|
| Version | Left | V-L | • | |
| | Right | V-R | ◦ | |
| Backrest finish | Upholstery | BA-⑤ | • | |
| Seat finish | Upholstery | Upholstery type is the same as for backrest, colours may vary | SE-⑤ | • |
| Base finish | Powder-coated steel | BC-③ | • | |
| Media – position A | None | | • | |
| | Media port Phase 1 × power socket 1 × double USB charger USB (A + C) | Black colour | A-YJ001-⑧-B | 400 |
| Media – position B | None | | • | |
| | Media port Phase 1 × power socket 1 × double USB charger USB (A + C) | Black colour | B-YJ001-⑧-B | 400 |
| External table (all board elements in the same colour) | 1 pcs Table width 290 mm | Melamine (MFC) | | 75 |
| | | Laminate | TF-①-J1 | 153 |
| | | Fenix NTM® | | 166 |
| | 2 pcs Table width 290 mm | Compact laminat | | 185 |
| | | Melamine (MFC) | TF-①-J2 | 150 |
| | | Laminate | | 306 |
| | Fenix NTM® | 332 | | |
| | Compact laminat | | 370 | |

① – Please specify table top colour code – [see finishes](#)

③ – Please specify metal colour code – [see finishes](#)

⑤ – Please specify upholstery colour code from selected price group – [see finishes](#)

⑧ – Please specify media port standard: CH13, FR, GB, GE

• Available as standard (included in basic price)

◦ Available as an option (included in basic price)

PRICE GROUP 2: Cura, Cura Loop, Valencia, Xtreme

PRICE GROUP 3: Chili, Moulin-Fr, Silvertex, Step/Step Melange

PRICE GROUP 4: Blazer, Main Line Flax, Oceanic, skai Parotega, Synergy

PRICE GROUP 5: Remix 3

PRICE GROUP 6: Nappa Leather, Arona Leather

GENAYA SOFA SET L-SHAPE 2 EX

| | | | | |
|--|---|--|-----------|-----|
| Tablet – position A (all board elements in the same colour) | None | | | • |
| | Melamine (MFC) | | | 75 |
| | Laminate | A-T- ^① | | 160 |
| | Fenix NTM® | | | 185 |
| | Compact laminat | | | 195 |
| Tablet – position B (all board elements in the same colour) | None | | | • |
| | Melamine (MFC) | | | 75 |
| | Laminate | B-T- ^① | | 160 |
| | Fenix NTM® | | | 185 |
| | Compact laminat | | | 195 |
| Glides | Plastic glides | GD | | • |
| | Nonskid glides | GDN | | 7 |
| | Glides with screwed floor fixing | GDS | | 45 |
| | Glides with glued floor fixing | GDG | | 10 |
| Foam | Flame retardant | FFR2 | | • |
| | Flame retardant with fireproof fabric | FFRF | | 600 |
| Wood and wood-based materials | Raw material – EU timber regulation, from certified forests, FSC certificate – authorized companies | For models without board elements | FSC | • |
| | Raw material – EU Timber regulation | For models with board elements (Melamine, Laminate, Fenix) | EUTR | ◦ |
| | Raw material – EU timber regulation, from certified forests, FSC certificate – authorized companies | For models with board elements (Compact Laminate) | FSCMIX | ◦ |
| Assembly | Unassembled, cardboard packaging | | PACK-UA | • |
| | Partially assembled, no packaging | | PACK-ABDF | ◦ |
| Sample order | GENAYA SOFA SET L-SHAPE 2 EX (BA-VL4001 SE-VL4001 BC-BL GD FFR2 FSC PACK-UA) | | | |

^① – Please specify table top colour code– [see finishes](#)

- Available as standard (included in basic price)
- Available as an option (included in basic price)

Price list

Genaya sofa arrangement

Seat and backrest – upholstered, flame retardant injected foam.
Base – frame and legs made of powder-coated steel. Black plastic glides.



Genaya sofa arrangement U-SHAPE 1 internal Genaya sofa arrangement U-SHAPE 1 external

GENAYA SOFA SET U-SHAPE 1 INT **GENAYA SOFA SET U-SHAPE 1 EX**

| | |
|--|--|
| Arrangement surface: 2605 × 2485 mm H 815 mm SH 450 mm WT 205,0 kg | Arrangement surface: 2605 × 2485 mm H 815 mm SH 450 mm WT 189,0 kg |
|--|--|

Basic price (EUR) according to upholstery price group

| | | |
|---|------|------|
| 2 | 5658 | 5362 |
| 3 | 5808 | 5496 |
| 4 | 6023 | 5703 |
| 5 | 6289 | 5951 |
| 6 | 9146 | 8658 |

| | | | | | |
|---|--|---|-------------|-----|-----|
| Backrest finish | Upholstery | | BA-⑤ | • | • |
| Seat finish | Upholstery | Upholstery type is the same as for backrest, colours may vary | SE-⑤ | • | • |
| Base finish | Powder-coated steel | | BC-③ | • | • |
| Media – position A | None | | | • | • |
| | Media port Phase 1 × power socket 1 × double USB charger USB (A + C) | Black colour | A-YJ001-⑧-B | 400 | 400 |
| Media – position B | None | | | • | • |
| | Media port Phase 1 × power socket 1 × double USB charger USB (A + C) | Black colour | B-YJ001-⑧-B | 400 | 400 |
| External table (all board elements in the same colour) | None | | | • | • |
| | 1 pcs Table width 290 mm | Melamine (MFC) | TF-①-J1 | 75 | 75 |
| | | Laminate | | 153 | 153 |
| | | Fenix NTM® | | 166 | 166 |
| | | Compact laminat | | 185 | 185 |
| | 2 pcs Table width 290 mm | Melamine (MFC) | TF-①-J2 | 150 | 150 |
| | | Laminate | | 306 | 306 |
| | | Fenix NTM® | | 332 | 332 |
| Compact laminat | | 370 | | 370 | |

- ① – Please specify table top colour code – [see finishes](#)
- ③ – Please specify metal colour code – [see finishes](#)
- ⑤ – Please specify upholstery colour code from selected price group – [see finishes](#)
- ⑧ – Please specify media port standard: CH13, FR, GB, GE

• Available as standard (included in basic price)

PRICE GROUP 2: Cura, Cura Loop, Valencia, Xtreme
PRICE GROUP 3: Chili, Moulin-Fr, Silvertex, Step/Step Melange
PRICE GROUP 4: Blazer, Main Line Flax, Oceanic, skai Parotega, Synergy
PRICE GROUP 5: Remix 3
PRICE GROUP 6: Nappa Leather, Arona Leather

| | | | | GENAYA SOFA SET U-SHAPE 1 INT | GENAYA SOFA SET U-SHAPE 1 EX |
|--|---|--|-----------|----------------------------------|---------------------------------|
| Tablet – position A (all board elements in the same colour) | None | | | • | • |
| | Melamine (MFC) | | | 75 | 75 |
| | Laminate | A-T- ^① | | 160 | 160 |
| | Fenix NTM® | | | 185 | 185 |
| | Compact laminat | | | 195 | 195 |
| Tablet – position B (all board elements in the same colour) | None | | | • | • |
| | Melamine (MFC) | | | 75 | 75 |
| | Laminate | B-T- ^① | | 160 | 160 |
| | Fenix NTM® | | | 185 | 185 |
| | Compact laminat | | | 195 | 195 |
| Glides | Plastic glides | GD | | • | • |
| | Nonskid glides | GDN | | 7 | 7 |
| | Glides with screwed floor fixing | GDS | | 45 | 45 |
| | Glides with glued floor fixing | GDG | | 10 | 10 |
| Foam | Flame retardant | FFR2 | | • | • |
| | Flame retardant with fireproof fabric | FFRF | | 825 | 725 |
| Wood and wood- -based materials | Raw material – EU timber regulation, from certified forests, FSC certificate – authorized companies | For models without board elements | FSC | • | • |
| | Raw material – EU Timber regulation | For models with board elements (Melamine, Laminate, Fenix) | EUTR | ◦ | ◦ |
| | Raw material – EU timber regulation, from certified forests, FSC certificate – authorized companies | For models with board elements (Compact Laminate) | FSCMIX | ◦ | ◦ |
| Assembly | Unassembled, cardboard packaging | | PACK-UA | • | • |
| | Partially assembled, no packaging | | PACK-ABDF | ◦ | ◦ |
| Sample order | GENAYA SOFA SET U-SHAPE 1 INT (BA-VL4001 SE-VL4001 BC-BL GD FFR2 FSC PACK-UA) | | | | |

^① – Please specify table top colour code– [see finishes](#)

- Available as standard (included in basic price)
- Available as an option (included in basic price)

Price list

Genaya sofa arrangement

Seat and backrest – upholstered, flame retardant injected foam.
Base – frame and legs made of powder-coated steel. Black plastic glides.

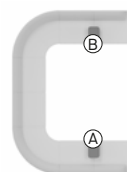

Genaya sofa arrangement U-SHAPE 2 internal

GENAYA SOFA SET U-SHAPE 2 INT

Arrangement surface: 3310 × 2485 mm
H 815 mm
SH 450 mm
WT 226,0 kg

Basic price (EUR) according to upholstery price group

| | |
|---|------|
| 2 | 6093 |
| 3 | 6248 |
| 4 | 6482 |
| 5 | 6764 |
| 6 | 9841 |

| | | | | |
|---|--|---|--------------------------|-----|
| Backrest finish | Upholstery | | BA- ^⑤ | • |
| Seat finish | Upholstery | Upholstery type is the same as for backrest, colours may vary | SE- ^⑤ | • |
| Base finish | Powder-coated steel | | BC- ^③ | • |
| Media – position A | None | | | • |
| | Media port Phase 1 × power socket 1 × double USB charger USB (A + C) | Black colour | A-YJ001- ^⑧ -B | 400 |
| Media – position B | None | | | • |
| | Media port Phase 1 × power socket 1 × double USB charger USB (A + C) | Black colour | B-YJ001- ^⑧ -B | 400 |
| | None | | | • |
| External table (all board elements in the same colour) | | Melamine (MFC) | | 75 |
| | 1 pcs Table width 290 mm | Laminate | TF- ^① -J1 | 153 |
| | | Fenix NTM® | | 166 |
| | | Compact laminat | | 185 |
| | | Melamine (MFC) | | 150 |
| | 2 pcs Table width 290 mm | Laminate | TF- ^① -J2 | 306 |
| | | Fenix NTM® | | 332 |
| | | Compact laminat | | 370 |

① – Please specify table top colour code – [see finishes](#)

③ – Please specify metal colour code – [see finishes](#)

⑤ – Please specify upholstery colour code from selected price group – [see finishes](#)

⑧ – Please specify media port standard: CH13, FR, GB, GE

• Available as standard (included in basic price)

PRICE GROUP 2: Cura, Cura Loop, Valencia, Xtreme

PRICE GROUP 3: Chili, Moulin-Fr, Silvertex, Step/Step Melange

PRICE GROUP 4: Blazer, Main Line Flax, Oceanic, skai Parotega, Synergy

PRICE GROUP 5: Remix 3

PRICE GROUP 6: Nappa Leather, Arona Leather

GENAYA SOFA SET U-SHAPE 2 INT

| | | | | |
|--|---|--|-----------|-----|
| Tablet – position A (all board elements in the same colour) | None | | | • |
| | Melamine (MFC) | | | 75 |
| | Laminate | A-T-① | | 160 |
| | Fenix NTM® | | | 185 |
| | Compact laminat | | | 195 |
| Tablet – position B (all board elements in the same colour) | None | | | • |
| | Melamine (MFC) | | | 75 |
| | Laminate | B-T-① | | 160 |
| | Fenix NTM® | | | 185 |
| | Compact laminat | | | 195 |
| Glides | Plastic glides | GD | | • |
| | Nonskid glides | GDN | | 7 |
| | Glides with screwed floor fixing | GDS | | 45 |
| | Glides with glued floor fixing | GDG | | 10 |
| Foam | Flame retardant | FFR2 | | • |
| | Flame retardant with fireproof fabric | FFRF | | 920 |
| Wood and wood-based materials | Raw material – EU timber regulation, from certified forests, FSC certificate – authorized companies | For models without board elements | FSC | • |
| | Raw material – EU Timber regulation | For models with board elements (Melamine, Laminate, Fenix) | EUTR | ◦ |
| | Raw material – EU timber regulation, from certified forests, FSC certificate – authorized companies | For models with board elements (Compact Laminate) | FSCMIX | ◦ |
| Assembly | Unassembled, cardboard packaging | | PACK-UA | • |
| | Partially assembled, no packaging | | PACK-ABDF | ◦ |
| Sample order | GENAYA SOFA SET U-SHAPE 2 INT (BA-VL4001 SE-VL4001 BC-BL GD FFR2 FSC PACK-UA) | | | |

① – Please specify table top colour code– [see finishes](#)

- Available as standard (included in basic price)
- Available as an option (included in basic price)

Price list

Genaya sofa arrangement

Seat and backrest – upholstered, flame retardant injected foam.
Base – frame and legs made of powder-coated steel. Black plastic glides.



Genaya sofa arrangement Z-SHAPE 1

GENAYA SOFA SET Z-SHAPE 1

Arrangement surface: 4300 × 1900 mm
H 815 mm
SH 450 mm
WT 172,0 kg



Basic price (EUR) according to upholstery price group

| | |
|---|------|
| 2 | 4805 |
| 3 | 4937 |
| 4 | 5111 |
| 5 | 5334 |
| 6 | 7677 |

| | | | | |
|---|--|---|-------------|-----|
| Backrest finish | Upholstery | | BA-⑤ | • |
| Seat finish | Upholstery | Upholstery type is the same as for backrest, colours may vary | SE-⑤ | • |
| Base finish | Powder-coated steel | | BC-③ | • |
| Media – position A | None | | | • |
| | Media port Phase 1 × power socket 1 × double USB charger USB (A + C) | Black colour | A-YJ001-⑧-B | 400 |
| | None | | | • |
| Media – position B | None | | | • |
| | Media port Phase 1 × power socket 1 × double USB charger USB (A + C) | Black colour | B-YJ001-⑧-B | 400 |
| | None | | | • |
| External table (all board elements in the same colour) | 1 pcs Table width 290 mm | Melamine (MFC) | TF-①-J1 | 75 |
| | | Laminate | | 153 |
| | | Fenix NTM® | | 166 |
| | | Compact laminat | | 185 |
| | 2 pcs Table width 290 mm | Melamine (MFC) | TF-①-J2 | 150 |
| | | Laminate | | 306 |
| | | Fenix NTM® | | 332 |
| | Compact laminat | | 370 | |

① – Please specify table top colour code – [see finishes](#)

③ – Please specify metal colour code – [see finishes](#)

⑤ – Please specify upholstery colour code from selected price group – [see finishes](#)

⑧ – Please specify media port standard: CH13, FR, GB, GE

• Available as standard (included in basic price)

PRICE GROUP 2: Cura, Cura Loop, Valencia, Xtreme

PRICE GROUP 3: Chili, Moulin-Fr, Silvertex, Step/Step Melange

PRICE GROUP 4: Blazer, Main Line Flax, Oceanic, skai Parotega, Synergy

PRICE GROUP 5: Remix 3

PRICE GROUP 6: Nappa Leather, Arona Leather

GENAYA SOFA SET Z-SHAPE 1

| | | | | |
|--|---|--|-----------|-----|
| Tablet – position A (all board elements in the same colour) | None | | | • |
| | Melamine (MFC) | | | 75 |
| | Laminate | A-T-① | | 160 |
| | Fenix NTM® | | | 185 |
| | Compact laminat | | | 195 |
| Tablet – position B (all board elements in the same colour) | None | | | • |
| | Melamine (MFC) | | | 75 |
| | Laminate | B-T-① | | 160 |
| | Fenix NTM® | | | 185 |
| | Compact laminat | | | 195 |
| Glides | Plastic glides | GD | | • |
| | Nonskid glides | GDN | | 7 |
| | Glides with screwed floor fixing | GDS | | 45 |
| | Glides with glued floor fixing | GDG | | 10 |
| Foam | Flame retardant | FFR2 | | • |
| | Flame retardant with fireproof fabric | FFRF | | 680 |
| Wood and wood-based materials | Raw material – EU timber regulation, from certified forests, FSC certificate – authorized companies | For models without board elements | FSC | • |
| | Raw material – EU Timber regulation | For models with board elements (Melamine, Laminate, Fenix) | EUTR | ◦ |
| | Raw material – EU timber regulation, from certified forests, FSC certificate – authorized companies | For models with board elements (Compact Laminate) | FSCMIX | ◦ |
| Assembly | Unassembled, cardboard packaging | | PACK-UA | • |
| | Partially assembled, no packaging | | PACK-ABDF | ◦ |
| Sample order | GENAYA SOFA SET Z-SHAPE 1 (BA-VL4001 SE-VL4001 BC-BL GD FFR2 FSC PACK-UA) | | | |

① – Please specify table top colour code– [see finishes](#)

- Available as standard (included in basic price)
- Available as an option (included in basic price)

Price list

Genaya sofa arrangement

Seat and backrest – upholstered, flame retardant injected foam.
Base – frame and legs made of powder-coated steel. Black plastic glides.

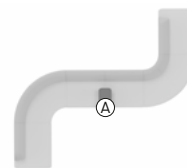

Genaya sofa arrangement Z-SHAPE 2

GENAYA SOFA SET Z-SHAPE 2

Arrangement surface: 3310 × 2890 mm
H 815 mm
SH 450 mm
WT 175,5 kg

Basic price (EUR) according to upholstery price group

| | |
|---|------|
| 2 | 5075 |
| 3 | 5212 |
| 4 | 5405 |
| 5 | 5644 |
| 6 | 8207 |

| | | | | |
|---|------------------------------------|---|---------------|-----|
| Backrest finish | Upholstery | | BA-(5) | • |
| Seat finish | Upholstery | Upholstery type is the same as for backrest, colours may vary | SE-(5) | • |
| Base finish | Powder-coated steel | | BC-(3) | • |
| Media – position A | None | | | • |
| | Media port Phase | | | |
| | 1 × power socket | Black colour | A-YJ001-(8)-B | 400 |
| | 1 × double USB charger USB (A + C) | | | |
| | None | | | • |
| | | Melamine (MFC) | | 75 |
| External table (all board elements in the same colour) | 1 pcs | Laminate | TF-(1)-J1 | 153 |
| | Table width 290 mm | Fenix NTM® | | 166 |
| | | Compact laminat | | 185 |
| | | Melamine (MFC) | | 150 |
| | 2 pcs | Laminate | TF-(1)-J2 | 306 |
| | Table width 290 mm | Fenix NTM® | | 332 |
| | | Compact laminat | | 370 |

① – Please specify table top colour code– [see finishes](#)

③ – Please specify metal colour code – [see finishes](#)

⑤ – Please specify upholstery colour code from selected price group – [see finishes](#)

⑧ – Please specify media port standard: CH13, FR, GB, GE

• Available as standard (included in basic price)

PRICE GROUP 2: Cura, Cura Loop, Valencia, Xtreme

PRICE GROUP 3: Chili, Moulin-Fr, Silvertex, Step/Step Melange

PRICE GROUP 4: Blazer, Main Line Flax, Oceanic, skai Parotega, Synergy

PRICE GROUP 5: Remix 3

PRICE GROUP 6: Nappa Leather, Arona Leather

GENAYA SOFA SET Z-SHAPE 2

| | | | | |
|--|---|--|-----------|-----|
| Tablet – position A (all board elements in the same colour) | None | | | • |
| | Melamine (MFC) | | | 75 |
| | Laminate | A-T-① | | 160 |
| | Fenix NTM® | | | 185 |
| | Compact laminat | | | 195 |
| Glides | Plastic glides | GD | | • |
| | Nonskid glides | GDN | | 7 |
| | Glides with screwed floor fixing | GDS | | 45 |
| | Glides with glued floor fixing | GDG | | 10 |
| Foam | Flame retardant | FFR2 | | • |
| | Flame retardant with fireproof fabric | FFRF | | 630 |
| Wood and wood-based materials | Raw material – EU timber regulation, from certified forests, FSC certificate – authorized companies | For models without board elements | FSC | • |
| | Raw material – EU Timber regulation | For models with board elements (Melamine, Laminate, Fenix) | EUTR | ◦ |
| | Raw material – EU timber regulation, from certified forests, FSC certificate – authorized companies | For models with board elements (Compact Laminate) | FSCMIX | ◦ |
| Assembly | Unassembled, cardboard packaging | | PACK-UA | • |
| | Partially assembled, no packaging | | PACK-ABDF | ◦ |
| Sample order | GENAYA SOFA SET Z-SHAPE 2 (BA-VL4001 SE-VL4001 BC-BL GD FFR2 FSC PACK-UA) | | | |

① – Please specify table top colour code– [see finishes](#)

- Available as standard (included in basic price)
- Available as an option (included in basic price)

Price list

Genaya sofa arrangement

Seat and backrest – upholstered, flame retardant injected foam.
Base – frame and legs made of powder-coated steel. Black plastic glides.



Genaya sofa arrangement S-SHAPE 3

GENAYA SOFA SET S-SHAPE 3

Arrangement surface: 4725 × 1625 mm
H 815 mm
SH 450 mm
WT 172,0 kg

Basic price (EUR) according to upholstery price group

| | |
|---|------|
| 2 | 4582 |
| 3 | 4703 |
| 4 | 4870 |
| 5 | 5080 |
| 6 | 7310 |

| | | | | |
|---|--|---|---------------|-----|
| Backrest finish | Upholstery | | BA-(5) | • |
| Seat finish | Upholstery | Upholstery type is the same as for backrest, colours may vary | SE-(5) | • |
| Base finish | Powder-coated steel | | BC-(3) | • |
| | None | | | • |
| Media – position A | Media port Phase 1 × power socket 1 × double USB charger USB (A + C) | Black colour | A-YJ001-(8)-B | 400 |
| | None | | | • |
| Media – position B | Media port Phase 1 × power socket 1 × double USB charger USB (A + C) | Black colour | B-YJ001-(8)-B | 400 |
| | None | | | • |
| External table (all board elements in the same colour) | 1 pcs Table width 290 mm | Melamine (MFC) | TF-(1)-J1 | 75 |
| | | Laminate | | 153 |
| | | Fenix NTM® | | 166 |
| | 2 pcs Table width 290 mm | Compact laminat | TF-(1)-J2 | 185 |
| | | Melamine (MFC) | | 150 |
| | | Laminate | | 306 |
| | Fenix NTM® | 332 | | |
| | Compact laminat | 370 | | |

① – Please specify table top colour code – [see finishes](#)

③ – Please specify metal colour code – [see finishes](#)

⑤ – Please specify upholstery colour code from selected price group – [see finishes](#)

⑧ – Please specify media port standard: CH13, FR, GB, GE

• Available as standard (included in basic price)

PRICE GROUP 2: Cura, Cura Loop, Valencia, Xtreme

PRICE GROUP 3: Chili, Moulin-Fr, Silvertex, Step/Step Melange

PRICE GROUP 4: Blazer, Main Line Flax, Oceanic, skai Parotega, Synergy

PRICE GROUP 5: Remix 3

PRICE GROUP 6: Nappa Leather, Arona Leather

GENAYA SOFA SET S-SHAPE 3

| | | | | |
|--|---|--|-----------|-----|
| Tablet – position A (all board elements in the same colour) | None | | | • |
| | Melamine (MFC) | | | 75 |
| | Laminate | A-T- ^① | | 160 |
| | Fenix NTM® | | | 185 |
| | Compact laminat | | | 195 |
| Tablet – position B (all board elements in the same colour) | None | | | • |
| | Melamine (MFC) | | | 75 |
| | Laminate | B-T- ^① | | 160 |
| | Fenix NTM® | | | 185 |
| | Compact laminat | | | 195 |
| Glides | Plastic glides | GD | | • |
| | Nonskid glides | GDN | | 7 |
| | Glides with screwed floor fixing | GDS | | 45 |
| | Glides with glued floor fixing | GDG | | 10 |
| Foam | Flame retardant | FFR2 | | • |
| | Flame retardant with fireproof fabric | FFRF | | 630 |
| Wood and wood-based materials | Raw material – EU timber regulation, from certified forests, FSC certificate – authorized companies | For models without board elements | FSC | • |
| | Raw material – EU Timber regulation | For models with board elements (Melamine, Laminate, Fenix) | EUTR | ◦ |
| | Raw material – EU timber regulation, from certified forests, FSC certificate – authorized companies | For models with board elements (Compact Laminate) | FSCMIX | ◦ |
| Assembly | Unassembled, cardboard packaging | | PACK-UA | • |
| | Partially assembled, no packaging | | PACK-ABDF | ◦ |
| Sample order | GENAYA SOFA SET S-SHAPE 3 (BA-VL4001 SE-VL4001 BC-BL GD FFR2 FSC PACK-UA) | | | |

^① – Please specify table top colour code– [see finishes](#)

- Available as standard (included in basic price)
- Available as an option (included in basic price)

Price list

Genaya sofa arrangement

Seat and backrest – upholstered, flame retardant injected foam.
Base – frame and legs made of powder-coated steel. Black plastic glides.

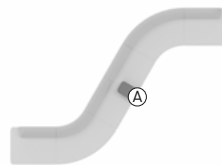

Genaya sofa arrangement S-SHAPE 4

GENAYA SOFA SET S-SHAPE 4

Arrangement surface: 4020 × 2850 mm
H 815 mm
SH 450 mm
WT 175,5 kg

Basic price (EUR) according to upholstery price group

| | |
|---|------|
| 2 | 4852 |
| 3 | 4978 |
| 4 | 5164 |
| 5 | 5390 |
| 6 | 7840 |

| | | | | |
|--|--|---|---------------|-----|
| Backrest finish | Upholstery | | BA-(5) | • |
| Seat finish | Upholstery | Upholstery type is the same as for backrest, colours may vary | SE-(5) | • |
| Base finish | Powder-coated steel | | BC-(3) | • |
| Media – position A | None | | | • |
| | Media port Phase 1 × power socket 1 × double USB charger USB (A + C) | Black colour | A-YJ001-(8)-B | 400 |
| External table (all board elements in the same colour) | None | | | • |
| | 1 pcs Table width 290 mm | Melamine (MFC) | TF-(1)-J1 | 75 |
| | | Laminate | | 153 |
| | | Fenix NTM® | | 166 |
| | 2 pcs Table width 290 mm | Compact laminat | TF-(1)-J2 | 185 |
| | | Melamine (MFC) | | 150 |
| Laminate | | 306 | | |
| | Fenix NTM® | 332 | | |
| | Compact laminat | 370 | | |
| Tablet – position A (all board elements in the same colour) | None | | | • |
| | Melamine (MFC) | A-T-(1) | 75 | |
| | Laminate | | 160 | |
| | Fenix NTM® | | 185 | |
| Compact laminat | 195 | | | |

(1) – Please specify table top colour code – [see finishes](#)

(3) – Please specify metal colour code – [see finishes](#)

(5) – Please specify upholstery colour code from selected price group – [see finishes](#)

(8) – Please specify media port standard: CH13, FR, GB, GE

• Available as standard (included in basic price)

PRICE GROUP 2: Cura, Cura Loop, Valencia, Xtreme

PRICE GROUP 3: Chili, Moulin-Fr, Silvertex, Step/Step Melange

PRICE GROUP 4: Blazer, Main Line Flax, Oceanic, skai Parotega, Synergy

PRICE GROUP 5: Remix 3

PRICE GROUP 6: Nappa Leather, Arona Leather

GENAYA SOFA SET S-SHAPE 4

| | | | | |
|--------------------------------------|---|--|-----------|-----|
| Glides | Plastic glides | | GD | • |
| | Nonskid glides | | GDN | 7 |
| | Glides with screwed floor fixing | | GDS | 45 |
| | Glides with glued floor fixing | | GDG | 10 |
| Foam | Flame retardant | | FFR2 | • |
| | Flame retardant with fireproof fabric | | FFRF | 630 |
| Wood and wood-based materials | Raw material – EU timber regulation, from certified forests, FSC certificate – authorized companies | For models without board elements | FSC | • |
| | Raw material – EU Timber regulation | For models with board elements (Melamine, Laminate, Fenix) | EUTR | ◦ |
| | Raw material – EU timber regulation, from certified forests, FSC certificate – authorized companies | For models with board elements (Compact Laminate) | FSCMIX | ◦ |
| Assembly | Unassembled, cardboard packaging | | PACK-UA | • |
| | Partially assembled, no packaging | | PACK-ABDF | ◦ |
| Sample order | GENAYA SOFA SET S-SHAPE 4 (BA-VL4001 SE-VL4001 BC-BL GD FFR2 FSC PACK-UA) | | | |

- Available as standard (included in basic price)
- Available as an option (included in basic price)

Price list

Genaya sofa arrangement

Seat and backrest – upholstered, flame retardant injected foam.
Base – frame and legs made of powder-coated steel. Black plastic glides.

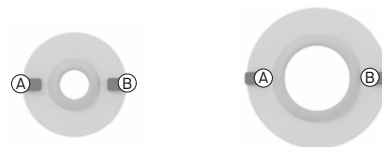

| Genaya sofa arrangement O-SHAPE 1 | Genaya sofa arrangement O-SHAPE 2 | |
|---|--|------|
| GENAYA SOFA SET O-SHAPE 1 | GENAYA SOFA SET O-SHAPE 2 | |
| Arrangement surface: 1900 × 1900 mm H 815 mm SH 450 mm WT 131,0 kg | Arrangement surface: 2580 × 2580 mm H 815 mm SH 450 mm WT 196,0 kg | |
| Basic price (EUR) according to upholstery price group | | |
| 2 | 4149 | 5652 |
| 3 | 4337 | 5892 |
| 4 | 4453 | 6036 |
| 5 | 4681 | 6324 |
| 6 | 6581 | 8724 |

| | | | | | |
|--|--|---|-------------|-----|-----|
| Backrest finish | Upholstery | | BA-⑤ | • | • |
| Seat finish | Upholstery | Upholstery type is the same as for backrest, colours may vary | SE-⑤ | • | • |
| Base finish | Powder-coated steel | | BC-③ | • | • |
| Media – position A | None | | | • | • |
| | Media port Phase 1 × power socket 1 × double USB charger USB (A + C) | Black colour | A-YJ001-⑧-B | 400 | 400 |
| Media – position B | None | | | • | • |
| | Media port Phase 1 × power socket 1 × double USB charger USB (A + C) | Black colour | B-YJ001-⑧-B | 400 | 400 |
| Tablet – position A (all board elements in the same colour) | None | | | • | • |
| | Melamine (MFC) | | | 75 | 75 |
| | Laminate | | A-T-① | 160 | 160 |
| | Fenix NTM® | | | 185 | 185 |
| | Compact laminat | | | 195 | 195 |
| Tablet – position B (all board elements in the same colour) | None | | | • | • |
| | Melamine (MFC) | | | 75 | 75 |
| | Laminate | | B-T-① | 160 | 160 |
| | Fenix NTM® | | | 185 | 185 |
| | Compact laminat | | | 195 | 195 |

- ① – Please specify table top colour code – [see finishes](#)
 ③ – Please specify metal colour code – [see finishes](#)
 ⑤ – Please specify upholstery colour code from selected price group – [see finishes](#)
 ⑧ – Please specify media port standard: CH13, FR, GB, GE

• Available as standard (included in basic price)

PRICE GROUP 2: Cura, Cura Loop, Valencia, Xtreme
 PRICE GROUP 3: Chili, Moulin-Fr, Silvertex, Step/Step Melange
 PRICE GROUP 4: Blazer, Main Line Flax, Oceanic, skai Parotega, Synergy
 PRICE GROUP 5: Remix 3
 PRICE GROUP 6: Nappa Leather, Arona Leather

| | | | GENAYA SOFA SET O-SHAPE 1 | GENAYA SOFA SET O-SHAPE 2 | |
|--------------------------------------|---|--|------------------------------|------------------------------|---|
| Glides | Plastic glides | GD | ● | ● | |
| | Nonskid glides | GDN | 7 | 7 | |
| | Glides with screwed floor fixing | GDS | 45 | 45 | |
| | Glides with glued floor fixing | GDG | 10 | 10 | |
| Foam | Flame retardant | FFR2 | ● | ● | |
| | Flame retardant with fireproof fabric | FFRF | 500 | 630 | |
| Wood and wood-based materials | Raw material – EU timber regulation, from certified forests, FSC certificate – authorized companies | For models without board elements | FSC | ● | ● |
| | Raw material – EU Timber regulation | For models with board elements (Melamine, Laminate, Fenix) | EUTR | ○ | ○ |
| | Raw material – EU timber regulation, from certified forests, FSC certificate – authorized companies | For models with board elements (Compact Laminate) | FSCMIX | ○ | ○ |
| Assembly | Unassembled, cardboard packaging | | PACK-UA | ● | ● |
| | Partially assembled, no packaging | | PACK-ABDF | ○ | ○ |
| Sample order | GENAYA SOFA SET O-SHAPE 1 (BA-VL4001 SE-VL4001 BC-BL GD FFR2 FSC PACK-UA) | | | | |

- Available as standard (included in basic price)
- Available as an option (included in basic price)

Price list

Genaya sofa arrangement

Seat and backrest – upholstered, flame retardant injected foam.
Base – frame and legs made of powder-coated steel. Black plastic glides.

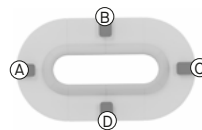

Genaya sofa arrangement O-SHAPE 3

GENAYA SOFA SET O-SHAPE 3

Arrangement surface: 3310 × 1900 mm
H 815 mm
SH 450 mm
WT 224,0 kg

Basic price (EUR) according to upholstery price group

| | |
|---|-------|
| 2 | 6539 |
| 3 | 6757 |
| 4 | 6985 |
| 5 | 7313 |
| 6 | 10531 |

| | | | | |
|--|--|---|-------------|-----|
| Backrest finish | Upholstery | | BA-⑤ | • |
| Seat finish | Upholstery | Upholstery type is the same as for backrest, colours may vary | SE-⑤ | • |
| Base finish | Powder-coated steel | | BC-③ | • |
| | None | | | • |
| Media – position A | Media port Phase 1 × power socket 1 × double USB charger USB (A + C) | Black colour | A-YJ001-⑧-B | 400 |
| | None | | | • |
| Media – position B | Media port Phase 1 × power socket 1 × double USB charger USB (A + C) | Black colour | B-YJ001-⑧-B | 400 |
| | None | | | • |
| Media – position C | Media port Phase 1 × power socket 1 × double USB charger USB (A + C) | Black colour | C-YJ001-⑧-B | 400 |
| | None | | | • |
| Media – position D | Media port Phase 1 × power socket 1 × double USB charger USB (A + C) | Black colour | D-YJ001-⑧-B | 400 |
| | None | | | • |
| Tablet – position A (all board elements in the same colour) | Melamine (MFC) | | | 75 |
| | Laminate | | A-T-① | 160 |
| | Fenix NTM® | | | 185 |
| | Compact laminat | | | 195 |

① – Please specify table top colour code– see finishes

③ – Please specify metal colour code – see finishes

⑤ – Please specify upholstery colour code from selected price group – see finishes

⑧ – Please specify media port standard: CH13, FR, GB, GE

• Available as standard (included in basic price)

PRICE GROUP 2: Cura, Cura Loop, Valencia, Xtreme

PRICE GROUP 3: Chili, Moulin-Fr, Silvertex, Step/Step Melange

PRICE GROUP 4: Blazer, Main Line Flax, Oceanic, skai Parotega, Synergy

PRICE GROUP 5: Remix 3

PRICE GROUP 6: Nappa Leather, Arona Leather

GENAYA SOFA SET O-SHAPE 3

| | | | | |
|--|---|--|-----------|-----|
| Tablet – position B (all board elements in the same colour) | None | | | • |
| | Melamine (MFC) | | | 75 |
| | Laminate | B-T-① | | 160 |
| | Fenix NTM® | | | 185 |
| | Compact laminat | | | 195 |
| Tablet – position C (all board elements in the same colour) | None | | | • |
| | Melamine (MFC) | | | 75 |
| | Laminate | C-T-① | | 160 |
| | Fenix NTM® | | | 185 |
| | Compact laminat | | | 195 |
| Tablet – position D (all board elements in the same colour) | None | | | • |
| | Melamine (MFC) | | | 75 |
| | Laminate | D-T-① | | 160 |
| | Fenix NTM® | | | 185 |
| | Compact laminat | | | 195 |
| Glides | Plastic glides | GD | | • |
| | Nonskid glides | GDN | | 7 |
| | Glides with screwed floor fixing | GDS | | 45 |
| | Glides with glued floor fixing | GDG | | 10 |
| Foam | Flame retardant | FFR2 | | • |
| | Flame retardant with fireproof fabric | FFRF | | 880 |
| Wood and wood-based materials | Raw material – EU timber regulation, from certified forests, FSC certificate – authorized companies | For models without board elements | FSC | • |
| | Raw material – EU Timber regulation | For models with board elements (Melamine, Laminate, Fenix) | EUTR | ◦ |
| | Raw material – EU timber regulation, from certified forests, FSC certificate – authorized companies | For models with board elements (Compact Laminate) | FSCMIX | ◦ |
| Assembly | Unassembled, cardboard packaging | | PACK-UA | • |
| | Partially assembled, no packaging | | PACK-ABDF | ◦ |

Sample order GENAYA SOFA SET O-SHAPE 3 (BA-VL4001 SE-VL4001 BC-BL GD FFR2 FSC PACK-UA)

① – Please specify table top colour code– see finishes

- Available as standard (included in basic price)
- Available as an option (included in basic price)

Price list

Genaya sofa arrangement

Seat and backrest – upholstered, flame retardant injected foam.
Base – frame and legs made of powder-coated steel. Black plastic glides.

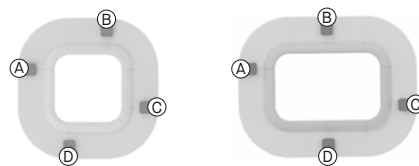

Genaya sofa arrangement O-SHAPE 5 Genaya sofa arrangement O-SHAPE 6

GENAYA SOFA SET O-SHAPE 5 **GENAYA SOFA SET O-SHAPE 6**

| | |
|--|--|
| Arrangement surface: 2605×2605 mm H 815 mm SH 450 mm WT 231,0 kg | Arrangement surface: 3310×2605 mm H 815 mm SH 450 mm WT 274,0 kg |
|--|--|

Basic price (EUR) according to upholstery price group

| | | |
|---|-------|-------|
| 2 | 6584 | 7949 |
| 3 | 6812 | 8187 |
| 4 | 7077 | 8490 |
| 5 | 7439 | 8884 |
| 6 | 11096 | 12981 |

| | | | | | |
|---------------------------|--|---|---------------|-----|-----|
| Backrest finish | Upholstery | | BA-(5) | • | • |
| Seat finish | Upholstery | Upholstery type is the same as for backrest, colours may vary | SE-(5) | • | • |
| Base finish | Powder-coated steel | | BC-(3) | • | • |
| Media – position A | None | | | • | • |
| | Media port Phase 1 × power socket 1 × double USB charger USB (A + C) | Black colour | A-YJ001-(8)-B | 400 | 400 |
| Media – position B | None | | | • | • |
| | Media port Phase 1 × power socket 1 × double USB charger USB (A + C) | Black colour | B-YJ001-(8)-B | 400 | 400 |
| Media – position C | None | | | • | • |
| | Media port Phase 1 × power socket 1 × double USB charger USB (A + C) | Black colour | C-YJ001-(8)-B | 400 | 400 |
| Media – position D | None | | | • | • |
| | Media port Phase 1 × power socket 1 × double USB charger USB (A + C) | Black colour | D-YJ001-(8)-B | 400 | 400 |

(3) – Please specify metal colour code – see finishes

(5) – Please specify upholstery colour code from selected price group – see finishes

(8) – Please specify media port standard: CH13, FR, GB, GE

• Available as standard (included in basic price)

PRICE GROUP 2: Cura, Cura Loop, Valencia, Xtreme
PRICE GROUP 3: Chili, Moulin-Fr, Silvertex, Step/Step Melange
PRICE GROUP 4: Blazer, Main Line Flax, Oceanic, skai Parotega, Synergy
PRICE GROUP 5: Remix 3
PRICE GROUP 6: Nappa Leather, Arona Leather

| | | | | GENAYA SOFA SET O-SHAPE 5 | GENAYA SOFA SET O-SHAPE 6 |
|--|---|--|-----------|------------------------------|------------------------------|
| Tablet – position A (all board elements in the same colour) | None | | | • | • |
| | Melamine (MFC) | | | 75 | 75 |
| | Laminate | A-T-① | | 160 | 160 |
| | Fenix NTM® | | | 185 | 185 |
| | Compact laminat | | | 195 | 195 |
| Tablet – position B (all board elements in the same colour) | None | | | • | • |
| | Melamine (MFC) | | | 75 | 75 |
| | Laminate | B-T-① | | 160 | 160 |
| | Fenix NTM® | | | 185 | 185 |
| | Compact laminat | | | 195 | 195 |
| Tablet – position C (all board elements in the same colour) | None | | | • | • |
| | Melamine (MFC) | | | 75 | 75 |
| | Laminate | C-T-① | | 160 | 160 |
| | Fenix NTM® | | | 185 | 185 |
| | Compact laminat | | | 195 | 195 |
| Tablet – position D (all board elements in the same colour) | None | | | • | • |
| | Melamine (MFC) | | | 75 | 75 |
| | Laminate | D-T-① | | 160 | 160 |
| | Fenix NTM® | | | 185 | 185 |
| | Compact laminat | | | 195 | 195 |
| Glides | Plastic glides | GD | | • | • |
| | Nonskid glides | GDN | | 7 | 7 |
| | Glides with screwed floor fixing | GDS | | 45 | 45 |
| | Glides with glued floor fixing | GDG | | 10 | 10 |
| Foam | Flame retardant | FFR2 | | • | • |
| | Flame retardant with fireproof fabric | FFRF | | 880 | 1070 |
| Wood and wood- based materials | Raw material – EU timber regulation, from certified forests, FSC certificate – authorized companies | For models without board elements | FSC | • | • |
| | Raw material – EU Timber regulation | For models with board elements (Melamine, Laminate, Fenix) | EUTR | ◦ | ◦ |
| | Raw material – EU timber regulation, from certified forests, FSC certificate – authorized companies | For models with board elements (Compact Laminate) | FSCMIX | ◦ | ◦ |
| Assembly | Unassembled, cardboard packaging | | PACK-UA | • | • |
| | Partially assembled, no packaging | | PACK-ABDF | - | ◦ |
| Sample order | GENAYA SOFA SET O-SHAPE 5 (BA-VL4001 SE-VL4001 BC-BL GD FFR2 FSC PACK-UA) | | | | |

① – Please specify table top colour code– [see finishes](#)

• Available as standard (included in basic price)

◦ Available as an option (included in basic price)

Price list

Genaya pouffe arrangement

Seat – upholstered, flame retardant injected foam.
Base – frame and legs made of powder-coated steel. Black plastic glides.

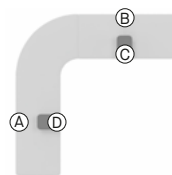

Genaya pouffe arrangement L-SHAPE 1

GENAYA POUFFE SET L-SHAPE 1

Arrangement surface: 2485 × 2485 mm
H 450 mm
SH 450 mm
WT 101,0 kg

Basic price (EUR) according to upholstery price group

| | |
|---|------|
| 2 | 2187 |
| 3 | 2236 |
| 4 | 2307 |
| 5 | 2401 |
| 6 | 3425 |

| | | | | |
|---|--|-----------------|--------------|-----|
| Seat finish | Upholstery | SE-⑤ | • | |
| Base finish | Powder-coated steel | BC-③ | • | |
| | None | | • | |
| Media | Media port Phase 1 × power socket 1 × double USB charger USB (A + C) Black colour | Position A | A-YJ001-⑧-B | 400 |
| | | Position B | B-YJ001-⑧-B | |
| | | Position C | C-YJ001-⑧-B | |
| | | Position D | D-YJ001-⑧-B | |
| | 2 × Media port Phase 1 × power socket 1 × double USB charger USB (A + C) Black colour | Position A, B | AB-YJ001-⑧-B | 800 |
| | | Position C, D | CD-YJ001-⑧-B | |
| External table (all board elements in the same colour) | 1 pcs Table width 290 mm | None | | • |
| | | Melamine (MFC) | | 75 |
| | | Laminate | TF-①-J1 | 153 |
| | | Fenix NTM® | | 166 |
| | 2 pcs Table width 290 mm | Compact laminat | | 185 |
| | | Melamine (MFC) | | 150 |
| | | Laminate | TF-①-J2 | 306 |
| | | Fenix NTM® | | 332 |
| Compact laminat | | 370 | | |

① – Please specify table top colour code – [see finishes](#)

③ – Please specify metal colour code – [see finishes](#)

⑤ – Please specify upholstery colour code from selected price group – [see finishes](#)

⑧ – Please specify media port standard: CH13, FR, GB, GE

• Available as standard (included in basic price)

PRICE GROUP 2: Cura, Cura Loop, Valencia, Xtreme
PRICE GROUP 3: Chili, Moulin-Fr, Silvertex, Step/Step Melange
PRICE GROUP 4: Blazer, Main Line Flax, Oceanic, skai Parotega, Synergy
PRICE GROUP 5: Remix 3
PRICE GROUP 6: Nappa Leather, Arona Leather

GENAYA POUFFE SET L-SHAPE 1

| | | | | | |
|--|---|--|--------|-----|-----|
| Tablet (all board elements in the same colour) | None | | | • | |
| | Melamine (MFC) | Position A | A-T-① | 75 | |
| | | Position B | B-T-① | | |
| | | Position C | C-T-① | | |
| | | Position D | D-T-① | | |
| | | Position A, B | AB-T-① | | 150 |
| | | Position C, D | CD-T-① | | |
| | Laminate HPL | Position A | A-T-① | 160 | |
| | | Position B | B-T-① | | |
| | | Position C | C-T-① | | |
| | | Position D | D-T-① | | |
| | | Position A, B | AB-T-① | | 320 |
| | | Position C, D | CD-T-① | | |
| | Fenix NTM® | Position A | A-T-① | 185 | |
| | | Position B | B-T-① | | |
| | | Position C | C-T-① | | |
| | | Position D | D-T-① | | |
| | | Position A, B | AB-T-① | | 370 |
| | | Position C, D | CD-T-① | | |
| | Compact Laminate | Position A | A-T-① | 195 | |
| | | Position B | B-T-① | | |
| | | Position C | C-T-① | | |
| | | Position D | D-T-① | | |
| | | Position A, B | AB-T-① | | 390 |
| Position C, D | | CD-T-① | | | |
| Glides | Plastic glides | GD | • | | |
| | Nonskid glides | GDN | 7 | | |
| | Glides with screwed floor fixing | GDS | 45 | | |
| | Glides with glued floor fixing | GDG | 10 | | |
| Foam | Flame retardant | FFR2 | • | | |
| | Flame retardant with fireproof fabric | FFRF | 335 | | |
| Wood and wood-based materials | Raw material – EU timber regulation, from certified forests, FSC certificate – authorized companies | For models without board elements | FSC | • | |
| | Raw material – EU Timber regulation | For models with board elements (Melamine, Laminate, Fenix) | EUTR | ◦ | |
| | Raw material – EU timber regulation, from certified forests, FSC certificate – authorized companies | For models with board elements (Compact Laminate) | FSCMIX | ◦ | |
| Assembly | Unassembled, cardboard packaging | PACK-UA | • | | |
| | Partially assembled, no packaging | PACK-ABDF | ◦ | | |

Sample order GENAYA POUFFE SET L-SHAPE 1 (BA-VL4001 SE-VL4001 BC-BL GD FFR2 FSC PACK-UA)

① – Please specify table top colour code– [see finishes](#)

- Available as standard (included in basic price)
- Available as an option (included in basic price)

Price list

Genaya pouffe arrangement

Seat – upholstered, flame retardant injected foam.
Base – frame and legs made of powder-coated steel. Black plastic glides.

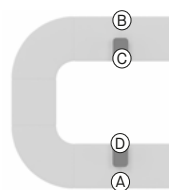

Genaya pouffe arrangement U-SHAPE 1

GENAYA POUFFE SET U-SHAPE 1

Arrangement surface: 2605 × 2485 mm
H 450 mm
SH 450 mm
WT 144,5kg

Basic price (EUR) according to upholstery price group

| | |
|---|------|
| 2 | 3246 |
| 3 | 3328 |
| 4 | 3433 |
| 5 | 3578 |
| 6 | 5110 |

| | | | | |
|---|--|-----------------|----------------|-----|
| Seat finish | Upholstery | SE-(5) | • | |
| Base finish | Powder-coated steel | BC-(3) | • | |
| | None | | • | |
| Media | Media port Phase 1 × power socket 1 × double USB charger USB (A + C) Black colour | Position A | A-YJ001-(8)-B | 400 |
| | | Position B | B-YJ001-(8)-B | |
| | | Position C | C-YJ001-(8)-B | |
| | | Position D | D-YJ001-(8)-B | |
| | 2 × Media port Phase 1 × power socket 1 × double USB charger USB (A + C) Black colour | Position A, B | AB-YJ001-(8)-B | 800 |
| | | Position C,D | CD-YJ001-(8)-B | |
| | None | | • | |
| External table (all board elements in the same colour) | 1 pcs Table width 290 mm | Melamine (MFC) | TF-(1)-J1 | 75 |
| | | Laminate | | 153 |
| | | Fenix NTM® | | 166 |
| | | Compact laminat | | 185 |
| | 2 pcs Table width 290 mm | Melamine (MFC) | TF-(1)-J2 | 150 |
| | | Laminate | | 306 |
| | | Fenix NTM® | | 332 |
| | | Compact laminat | | 370 |

(1) – Please specify table top colour code- [see finishes](#)

(3) – Please specify metal colour code – [see finishes](#)

(5) – Please specify upholstery colour code from selected price group – [see finishes](#)

(8) – Please specify media port standard: CH13, FR, GB, GE

• Available as standard (included in basic price)

PRICE GROUP 2: Cura, Cura Loop, Valencia, Xtreme

PRICE GROUP 3: Chili, Moulin-Fr, Silvertex, Step/Step Melange

PRICE GROUP 4: Blazer, Main Line Flax, Oceanic, skai Parotega, Synergy

PRICE GROUP 5: Remix 3

PRICE GROUP 6: Nappa Leather, Arona Leather

GENAYA POUFFE SET U-SHAPE 1

| | | | | | |
|--|---|--|--------|-----|-----|
| Tablet (all board elements in the same colour) | None | | | • | |
| | Melamine (MFC) | Position A | A-T-① | 75 | |
| | | Position B | B-T-① | | |
| | | Position C | C-T-① | | |
| | | Position D | D-T-① | | |
| | | Position A, B | AB-T-① | | 150 |
| | | Position C, D | CD-T-① | | |
| | Laminate HPL | Position A | A-T-① | 160 | |
| | | Position B | B-T-① | | |
| | | Position C | C-T-① | | |
| | | Position D | D-T-① | | |
| | | Position A, B | AB-T-① | | 320 |
| | | Position C, D | CD-T-① | | |
| | Fenix NTM® | Position A | A-T-① | 185 | |
| | | Position B | B-T-① | | |
| | | Position C | C-T-① | | |
| | | Position D | D-T-① | | |
| | | Position A, B | AB-T-① | | 370 |
| | | Position C, D | CD-T-① | | |
| | Compact Laminate | Position A | A-T-① | 195 | |
| | | Position B | B-T-① | | |
| | | Position C | C-T-① | | |
| | | Position D | D-T-① | | |
| | | Position A, B | AB-T-① | | 390 |
| Position C, D | | CD-T-① | | | |
| Glides | Plastic glides | GD | • | | |
| | Nonskid glides | GDN | 7 | | |
| | Glides with screwed floor fixing | GDS | 45 | | |
| | Glides with glued floor fixing | GDG | 10 | | |
| Foam | Flame retardant | FFR2 | • | | |
| | Flame retardant with fireproof fabric | FFRF | 490 | | |
| Wood and wood-based materials | Raw material – EU timber regulation, from certified forests, FSC certificate – authorized companies | For models without board elements | FSC | • | |
| | Raw material – EU Timber regulation | For models with board elements (Melamine, Laminate, Fenix) | EUTR | ◦ | |
| | Raw material – EU timber regulation, from certified forests, FSC certificate – authorized companies | For models with board elements (Compact Laminate) | FSCMIX | ◦ | |
| Assembly | Unassembled, cardboard packaging | PACK-UA | • | | |
| | Partially assembled, no packaging | PACK-ABDF | ◦ | | |

Sample order GENAYA POUFFE SET U-SHAPE 1 (BA-VL4001 SE-VL4001 BC-BL GD FFR2 FSC PACK-UA)

① – Please specify table top colour code– [see finishes](#)

- Available as standard (included in basic price)
- Available as an option (included in basic price)

Price list

Genaya pouffe arrangement

Seat – upholstered, flame retardant injected foam.
Base – frame and legs made of powder-coated steel. Black plastic glides.

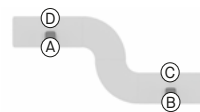

Genaya pouffe arrangement Z-SHAPE 1

GENAYA POUFFE SET Z-SHAPE 1

Arrangement surface: 4300 × 1900 mm
H 450 mm
SH 450 mm
WT 125,5 kg

Basic price (EUR) according to upholstery price group

| | |
|---|------|
| 2 | 2847 |
| 3 | 2921 |
| 4 | 3007 |
| 5 | 3131 |
| 6 | 4405 |

| | | | | |
|---|--|-----------------|----------------|-----|
| Seat finish | Upholstery | SE-(5) | • | |
| Base finish | Powder-coated steel | BC-(3) | • | |
| | None | | • | |
| Media | Media port Phase 1 × power socket 1 × double USB charger USB (A + C) Black colour | Position A | A-YJ001-(8)-B | 400 |
| | | Position B | B-YJ001-(8)-B | |
| | | Position C | C-YJ001-(8)-B | |
| | | Position D | D-YJ001-(8)-B | |
| | 2 × Media port Phase 1 × power socket 1 × double USB charger USB (A + C) Black colour | Position A, B | AB-YJ001-(8)-B | 800 |
| | | Position C, D | CD-YJ001-(8)-B | |
| | None | | • | |
| External table (all board elements in the same colour) | 1 pcs Table width 290 mm | Melamine (MFC) | TF-(1)-J1 | 75 |
| | | Laminate | | 153 |
| | | Fenix NTM® | | 166 |
| | | Compact laminat | | 185 |
| | 2 pcs Table width 290 mm | Melamine (MFC) | TF-(1)-J2 | 150 |
| | | Laminate | | 306 |
| | | Fenix NTM® | | 332 |
| | | Compact laminat | | 370 |

① – Please specify table top colour code – see finishes

③ – Please specify metal colour code – see finishes

⑤ – Please specify upholstery colour code from selected price group – see finishes

⑧ – Please specify media port standard: CH13, FR, GB, GE

• Available as standard (included in basic price)

PRICE GROUP 2: Cura, Cura Loop, Valencia, Xtreme
PRICE GROUP 3: Chili, Moulin-Fr, Silvertex, Step/Step Melange
PRICE GROUP 4: Blazer, Main Line Flax, Oceanic, skai Parotega, Synergy
PRICE GROUP 5: Remix 3
PRICE GROUP 6: Nappa Leather, Arona Leather

GENAYA POUFFE SET Z-SHAPE 1

| | | | | | |
|--|---|--|--------|-----|-----|
| Tablet (all board elements in the same colour) | None | | | • | |
| | Melamine (MFC) | Position A | A-T-① | 75 | |
| | | Position B | B-T-① | | |
| | | Position C | C-T-① | | |
| | | Position D | D-T-① | | |
| | | Position A, B | AB-T-① | | 150 |
| | | Position C, D | CD-T-① | | |
| | Laminate HPL | Position A | A-T-① | 160 | |
| | | Position B | B-T-① | | |
| | | Position C | C-T-① | | |
| | | Position D | D-T-① | | |
| | | Position A, B | AB-T-① | | 320 |
| | | Position C, D | CD-T-① | | |
| | Fenix NTM® | Position A | A-T-① | 185 | |
| | | Position B | B-T-① | | |
| | | Position C | C-T-① | | |
| | | Position D | D-T-① | | |
| | | Position A, B | AB-T-① | | 370 |
| | | Position C, D | CD-T-① | | |
| | Compact Laminate | Position A | A-T-① | 195 | |
| | | Position B | B-T-① | | |
| | | Position C | C-T-① | | |
| | | Position D | D-T-① | | |
| | | Position A, B | AB-T-① | | 390 |
| Position C, D | | CD-T-① | | | |
| Glides | Plastic glides | GD | • | | |
| | Nonskid glides | GDN | 7 | | |
| | Glides with screwed floor fixing | GDS | 45 | | |
| | Glides with glued floor fixing | GDG | 10 | | |
| Foam | Flame retardant | FFR2 | • | | |
| | Flame retardant with fireproof fabric | FFRF | 430 | | |
| Wood and wood-based materials | Raw material – EU timber regulation, from certified forests, FSC certificate – authorized companies | For models without board elements | FSC | • | |
| | Raw material – EU Timber regulation | For models with board elements (Melamine, Laminate, Fenix) | EUTR | ◦ | |
| | Raw material – EU timber regulation, from certified forests, FSC certificate – authorized companies | For models with board elements (Compact Laminate) | FSCMIX | ◦ | |
| Assembly | Unassembled, cardboard packaging | PACK-UA | • | | |
| | Partially assembled, no packaging | PACK-ABDF | ◦ | | |

Sample order GENAYA POUFFE SET Z-SHAPE 1 (BA-VL4001 SE-VL4001 BC-BL GD FFR2 FSC PACK-UA)

① – Please specify table top colour code – [see finishes](#)

- Available as standard (included in basic price)
- Available as an option (included in basic price)

Price list

Genaya pouffe arrangement

Seat – upholstered, flame retardant injected foam.

Base – frame and legs made of powder-coated steel. Black plastic glides.



Genaya pouffe arrangement S-SHAPE 2

GENAYA POUFFE SET S-SHAPE 2

Arrangement surface: 4725 × 1625 mm
H 450 mm
SH 450 mm
WT 125,5 kg

Basic price (EUR) according to upholstery price group

| | |
|---|------|
| 2 | 2847 |
| 3 | 2921 |
| 4 | 3007 |
| 5 | 3131 |
| 6 | 4405 |

| | | | | |
|---|--|-----------------|----------------|-----|
| Seat finish | Upholstery | SE-(5) | • | |
| Base finish | Powder-coated steel | BC-(3) | • | |
| | None | | • | |
| Media | Media port Phase 1 × power socket 1 × double USB charger USB (A + C) Black colour | Position A | A-YJ001-(8)-B | 400 |
| | | Position B | B-YJ001-(8)-B | |
| | | Position C | C-YJ001-(8)-B | |
| | | Position D | D-YJ001-(8)-B | |
| | 2 × Media port Phase 1 × power socket 1 × double USB charger USB (A + C) Black colour | Position A, B | AB-YJ001-(8)-B | 800 |
| | | Position C, D | CD-YJ001-(8)-B | |
| External table (all board elements in the same colour) | 1 pcs Table width 290 mm | Melamine (MFC) | TF-(1)-J1 | 75 |
| | | Laminate | | 153 |
| | | Fenix NTM® | | 166 |
| | 2 pcs Table width 290 mm | Compact laminat | TF-(1)-J2 | 185 |
| | | Melamine (MFC) | | 150 |
| | | Laminate | | 306 |
| | | Fenix NTM® | | 332 |
| | Compact laminat | | 370 | |

① – Please specify table top colour code – see finishes

③ – Please specify metal colour code – see finishes

⑤ – Please specify upholstery colour code from selected price group – see finishes

⑧ – Please specify media port standard: CH13, FR, GB, GE

• Available as standard (included in basic price)

PRICE GROUP 2: Cura, Cura Loop, Valencia, Xtreme

PRICE GROUP 3: Chili, Moulin-Fr, Silvertex, Step/Step Melange

PRICE GROUP 4: Blazer, Main Line Flax, Oceanic, skai Parotega, Synergy

PRICE GROUP 5: Remix 3

PRICE GROUP 6: Nappa Leather, Arona Leather

GENAYA POUFFE SET S-SHAPE 2

| | | | | | |
|--|---|--|--------|-----|-----|
| Tablet (all board elements in the same colour) | None | | | • | |
| | Melamine (MFC) | Position A | A-T-① | 75 | |
| | | Position B | B-T-① | | |
| | | Position C | C-T-① | | |
| | | Position D | D-T-① | | |
| | | Position A, B | AB-T-① | | 150 |
| | | Position C, D | CD-T-① | | |
| | Laminate HPL | Position A | A-T-① | 160 | |
| | | Position B | B-T-① | | |
| | | Position C | C-T-① | | |
| | | Position D | D-T-① | | |
| | | Position A, B | AB-T-① | | 320 |
| | | Position C, D | CD-T-① | | |
| | Fenix NTM® | Position A | A-T-① | 185 | |
| | | Position B | B-T-① | | |
| | | Position C | C-T-① | | |
| | | Position D | D-T-① | | |
| | | Position A, B | AB-T-① | | 370 |
| | | Position C, D | CD-T-① | | |
| | Compact Laminate | Position A | A-T-① | 195 | |
| | | Position B | B-T-① | | |
| | | Position C | C-T-① | | |
| | | Position D | D-T-① | | |
| | | Position A, B | AB-T-① | | 390 |
| Position C, D | | CD-T-① | | | |
| Glides | Plastic glides | GD | • | | |
| | Nonskid glides | GDN | 7 | | |
| | Glides with screwed floor fixing | GDS | 45 | | |
| | Glides with glued floor fixing | GDG | 10 | | |
| Foam | Flame retardant | FFR2 | • | | |
| | Flame retardant with fireproof fabric | FFRF | 400 | | |
| Wood and wood-based materials | Raw material – EU timber regulation, from certified forests, FSC certificate – authorized companies | For models without board elements | FSC | • | |
| | Raw material – EU Timber regulation | For models with board elements (Melamine, Laminate, Fenix) | EUTR | ◦ | |
| | Raw material – EU timber regulation, from certified forests, FSC certificate – authorized companies | For models with board elements (Compact Laminate) | FSCMIX | ◦ | |
| Assembly | Unassembled, cardboard packaging | PACK-UA | • | | |
| | Partially assembled, no packaging | PACK-ABDF | ◦ | | |

Sample order GENAYA POUFFE SET S-SHAPE 2 (BA-VL4001 SE-VL4001 BC-BL GD FFR2 FSC PACK-UA)

① – Please specify table top colour code – see finishes

- Available as standard (included in basic price)
- Available as an option (included in basic price)

Price list

Genaya pouffe arrangement

Seat – upholstered, flame retardant injected foam.
Base – frame and legs made of powder-coated steel. Black plastic glides.

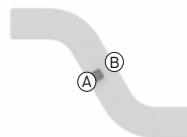

Genaya pouffe arrangement Z-SHAPE 3

GENAYA POUFFE SET Z-SHAPE 3

Arrangement surface: 4020 × 2850 mm
H 450 mm
SH 450 mm
WT 128,5 kg

Basic price (EUR) according to upholstery price group

| | |
|---|------|
| 2 | 2964 |
| 3 | 3042 |
| 4 | 3137 |
| 5 | 3272 |
| 6 | 4675 |

| | | | |
|---|--|--|-----|
| Seat finish | Upholstery | SE-(5) | • |
| Base finish | Powder-coated steel | BC-(3) | • |
| Media | None | | • |
| | Media port Phase 1 × power socket 1 × double USB charger USB (A + C) | Position A A-YJ001-(8)-B Position B B-YJ001-(8)-B | 400 |
| | Black colour None | | • |
| External table (all board elements in the same colour) | 1 pcs Table width 290 mm | Melamine (MFC) | 75 |
| | | Laminate | 153 |
| | | Fenix NTM® | 166 |
| | 2 pcs Table width 290 mm | Compact laminat | 185 |
| | | Melamine (MFC) | 150 |
| | | Laminate | 306 |
| | Fenix NTM® | 332 | |
| | Compact laminat | 370 | |

① – Please specify table top colour code – [see finishes](#)

③ – Please specify metal colour code – [see finishes](#)

⑤ – Please specify upholstery colour code from selected price group – [see finishes](#)

⑧ – Please specify media port standard: CH13, FR, GB, GE

• Available as standard (included in basic price)

PRICE GROUP 2: Cura, Cura Loop, Valencia, Xtreme
PRICE GROUP 3: Chili, Moulin-Fr, Silvertex, Step/Step Melange
PRICE GROUP 4: Blazer, Main Line Flax, Oceanic, skai Parotega, Synergy
PRICE GROUP 5: Remix 3
PRICE GROUP 6: Nappa Leather, Arona Leather

GENAYA POUFFE SET Z-SHAPE 3

| | | | | |
|---|---|--|-----------|-----|
| Tablet (all board elements in the same colour) | None | | | • |
| | Melamine (MFC) | Position A | A-T-① | 75 |
| | | Position B | B-T-① | |
| | | Position A, B | AB-T-① | 150 |
| | Laminate HPL | Position A | A-T-① | 160 |
| | | Position B | B-T-① | |
| | | Position A, B | AB-T-① | 320 |
| | Fenix NTM® | Position A | A-T-① | 185 |
| | | Position B | B-T-① | |
| | | Position A, B | AB-T-① | 370 |
| | Compact Laminate | Position A | A-T-① | 195 |
| | | Position B | B-T-① | |
| Position A, B | | AB-T-① | 390 | |
| Glides | Plastic glides | GD | | • |
| | Nonskid glides | GDN | | 7 |
| | Glides with screwed floor fixing | GDS | | 45 |
| | Glides with glued floor fixing | GDG | | 10 |
| Foam | Flame retardant | FFR2 | | • |
| | Flame retardant with fireproof fabric | FFRF | | 400 |
| Wood and wood-based materials | Raw material – EU timber regulation, from certified forests, FSC certificate – authorized companies | For models without board elements | FSC | • |
| | Raw material – EU Timber regulation | For models with board elements (Melamine, Laminate, Fenix) | EUTR | ◦ |
| | Raw material – EU timber regulation, from certified forests, FSC certificate – authorized companies | For models with board elements (Compact Laminate) | FSCMIX | ◦ |
| Assembly | Unassembled, cardboard packaging | | PACK-UA | • |
| | Partially assembled, no packaging | | PACK-ABDF | ◦ |
| Sample order | GENAYA POUFFE SET Z-SHAPE 3 (BA-VL4001 SE-VL4001 BC-BL GD FFR2 FSC PACK-UA) | | | |

① – Please specify table top colour code – see finishes

- Available as standard (included in basic price)
- Available as an option (included in basic price)

Price list

Genaya pouffe arrangement

Seat – upholstered, flame retardant injected foam.
Base – frame and legs made of powder-coated steel. Black plastic glides.

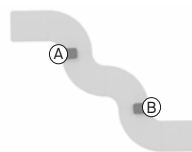

Genaya pouffe arrangement Z-SHAPE 4

GENAYA POUFFE SET Z-SHAPE 4

Arrangement surface: 4120 × 3130 mm
H 450 mm
SH 450 mm
WT 142,0 kg

Basic price (EUR) according to upholstery price group

| | |
|---|------|
| 2 | 3603 |
| 3 | 3719 |
| 4 | 3816 |
| 5 | 3979 |
| 6 | 5495 |

| | | | |
|---|--|---------------------------------|-----|
| Seat finish | Upholstery | SE-(5) | • |
| Base finish | Powder-coated steel | BC-(3) | • |
| | None | | • |
| Media | Media port Phase 1 × power socket 1 × double USB charger USB (A + C) Black colour | Position A A-YJ001-(8)-B | 400 |
| | | Position B B-YJ001-(8)-B | |
| | 2 × Media port Phase 1 × power socket 1 × double USB charger USB (A + C) Black colour | Position A, B AB-YJ001-(8)-B | 800 |
| | None | | • |
| External table (all board elements in the same colour) | 1 pcs Table width 290 mm | Melamine (MFC) | 75 |
| | | Laminate | 153 |
| | | Fenix NTM® | 166 |
| | 2 pcs Table width 290 mm | Compact laminat | 185 |
| | | Melamine (MFC) | 150 |
| | | Laminate | 306 |
| | Fenix NTM® | 332 | |
| | Compact laminat | 370 | |

- ① – Please specify table top colour code – [see finishes](#)
- ③ – Please specify metal colour code – [see finishes](#)
- ⑤ – Please specify upholstery colour code from selected price group – [see finishes](#)
- ⑧ – Please specify media port standard: CH13, FR, GB, GE

• Available as standard (included in basic price)

PRICE GROUP 2: Cura, Cura Loop, Valencia, Xtreme
PRICE GROUP 3: Chili, Moulin-Fr, Silvertex, Step/Step Melange
PRICE GROUP 4: Blazer, Main Line Flax, Oceanic, skai Parotega, Synergy
PRICE GROUP 5: Remix 3
PRICE GROUP 6: Nappa Leather, Arona Leather

GENAYA POUFFE SET Z-SHAPE 4

| | | | | |
|---|---|--|---------|-----|
| | None | | | • |
| Tablet (all board elements in the same colour) | Melamine (MFC) | Position A | A-T-① | 75 |
| | | Position B | B-T-① | |
| | Laminate HPL | Position A | A-T-① | 160 |
| | | Position B | B-T-① | |
| | Fenix NTM® | Position A | A-T-① | 185 |
| | | Position B | B-T-① | |
| | Compact Laminate | Position A | A-T-① | 195 |
| | | Position B | B-T-① | |
| Glides | Plastic glides | | GD | • |
| | Nonskid glides | | GDN | 7 |
| | Glides with screwed floor fixing | | GDS | 45 |
| | Glides with glued floor fixing | | GDG | 10 |
| Foam | Flame retardant | | FFR2 | • |
| | Flame retardant with fireproof fabric | | FFRF | 500 |
| Wood and wood-based materials | Raw material – EU timber regulation, from certified forests, FSC certificate – authorized companies | For models without board elements | FSC | • |
| | Raw material – EU Timber regulation | For models with board elements (Melamine, Laminate, Fenix) | EUTR | ◦ |
| | Raw material – EU timber regulation, from certified forests, FSC certificate – authorized companies | For models with board elements (Compact Laminate) | FSCMIX | ◦ |
| Assembly | Unassembled, cardboard packaging | | PACK-UA | • |
| Sample order | GENAYA POUFFE SET Z-SHAPE 3 (BA-VL4001 SE-VL4001 BC-BL GD FFR2 FSC PACK-UA) | | | |

① – Please specify table top colour code– [see finishes](#)

- Available as standard (included in basic price)
- Available as an option (included in basic price)

Finishes

Melamina

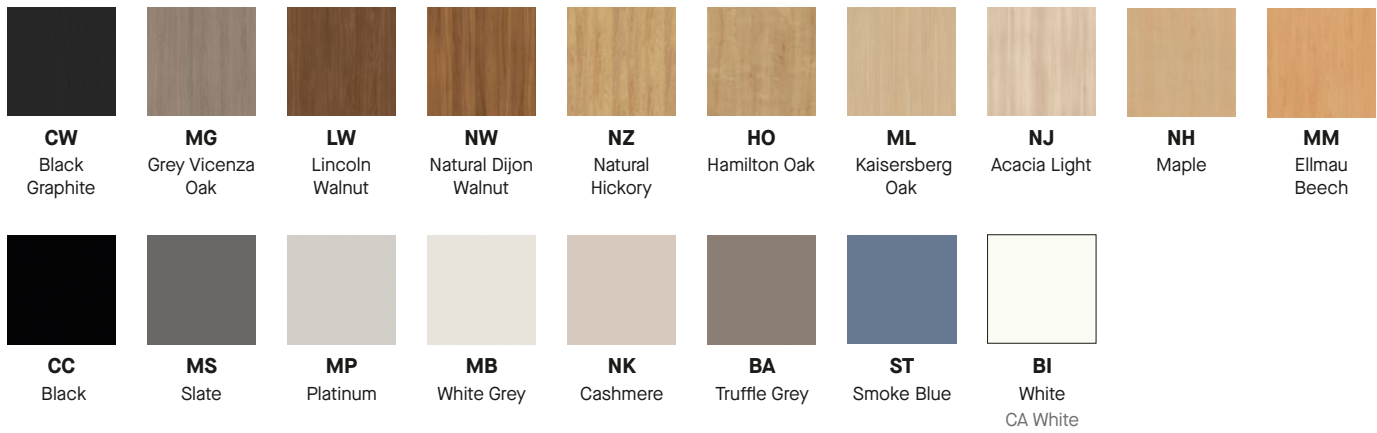

Laminate

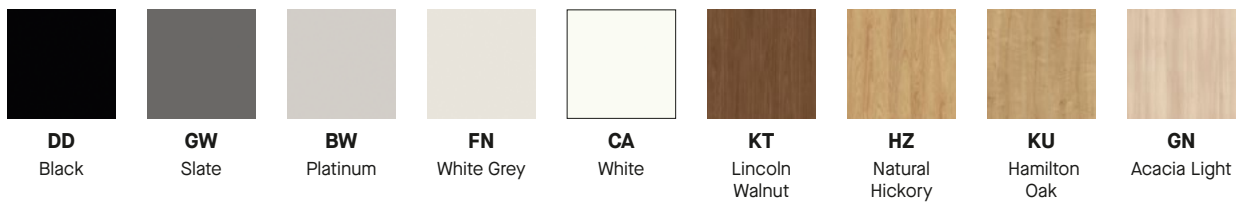

Fenix NTM®

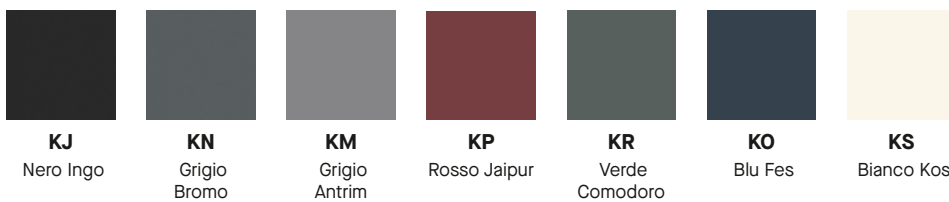

Metal



Compact Laminate



General notes

All specified dimensions are approximate. Subject to minor modifications or differences for reasons of design improvements or for technical reasons.

- W = width
- D = depth
- H = height
- DI = diameter
- SH = seat height
- SH DIN = seat height measured acc. to DIN EN 1335-1

In compliance with the highest quality standards "Quality is irreplaceable." Guided by this principle, each product line is subjected to stringent quality testing.

Only the products marked in this document are FSC® (FSC®-C120977).

Look for our FSC®-certified products. Sale of products that meet the FSC® requirements is possible only by Nowy Styl Sp. z o.o., Nowy Styl Nederland B.V. and Kusch + Co GmbH.



The mark of responsible forestry

The FSC certificate applies to responsible forest management and the entire flow of raw materials from the forest to the customer. Each stage of the chain is monitored in terms of social, ecological and economic performance. The product with the FSC label gives customers a guarantee that the wood used for the production of the product comes from sources managed in a sustainable manner.

Warranty

Manufacturer declares that the products shall be free from defects in material or workmanship. The warranty is given to the original purchaser only, for normal commercial usage.

Detailed terms of warranty and warranty periods are available at

<https://www.kusch.com/en/warranty>

8000 price list 2026

8000

Design by Studio F. A. Porsche

2, 3, 4, 5, 6-seater bench, metal seat and backrest



8000 BENCH 2U
4L M



8000 BENCH 3U
4L M



8000 BENCH 4U
4L M



8000 BENCH 5U
4L M



8000 BENCH 6U
4L M

2, 3, 4, 5, 6-seater bench, PU seat, metal backrest



8000 BENCH 2U
4L M/P



8000 BENCH 3U
4L M/P



8000 BENCH 4U
4L M/P



8000 BENCH 5U
4L M/P



8000 BENCH 6U
4L M/P

2, 3, 4, 5, 6-seater bench, PU seat and backrest



8000 BENCH 2U
4L P



8000 BENCH 3U
4L P



8000 BENCH 4U
4L P



8000 BENCH 5U
4L P



8000 BENCH 6U
4L P

2, 3, 4, 5, 6-seater bench, upholstered seat and backrest



8000 BENCH 2U
4L UPH



8000 BENCH 3U
4L UPH



8000 BENCH 4U
4L UPH



8000 BENCH 5U
4L UPH



8000 BENCH 6U
4L UPH

2, 3, 4, 5, 6-seater bench with table top, metal seat and backrest



8000 BENCH 2U
4L T M



8000 BENCH 3U
4L T M



8000 BENCH 4U
4L T M



8000 BENCH 5U
4L T M



8000 BENCH 6U
4L T M

2, 3, 4, 5, 6-seater bench with table top, PU seat, metal backrest



8000 BENCH 2U
4L T M/P



8000 BENCH 3U
4L T M/P



8000 BENCH 4U
4L T M/P



8000 BENCH 5U
4L T M/P



8000 BENCH 6U
4L T M/P

2, 3, 4, 5, 6-seater bench with table top, PU seat and backrest



8000 BENCH 2U
4L T P



8000 BENCH 3U
4L T P



8000 BENCH 4U
4L T P



8000 BENCH 5U
4L T P



8000 BENCH 6U
4L T P

2, 3, 4, 5, 6-seater bench with table top, upholstered seat and backrest



8000 BENCH 2U
4L T UPH



8000 BENCH 3U
4L T UPH



8000 BENCH 4U
4L T UPH



8000 BENCH 5U
4L T UPH



8000 BENCH 6U
4L T UPH

8000 2,3,4-seater bench, metal seat and backrest

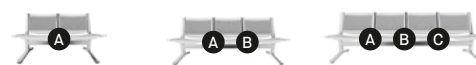

| 8000 BENCH 2U 4L M | 8000 BENCH 3U 4L M | 8000 BENCH 4U 4L M |
|-----------------------|-----------------------|-----------------------|
| Basic price (EUR) | | |
| 1734 | 2259 | 2781 |

| | Beam | Seat frame | Legs | | | | |
|-------------------------------|--------------------------------|-------------------------|-------------------------|--------------|-----|-----|-----|
| Frame | Powder-coated | Powder-coated aluminium | Powder-coated aluminium | E-③③③ | • | • | • |
| | | Powder-coated aluminium | Polished aluminium | | 45 | 45 | 45 |
| | | Polished aluminium | Powder-coated aluminium | | 121 | 156 | 191 |
| | | Polished aluminium | Polished aluminium | | 166 | 200 | 235 |
| Backrest | Powder-coated perforated steel | | BA-③ | • | • | • | |
| Seat | Powder-coated perforated steel | | SE-③ | • | • | • | |
| | None | | | • | • | • | |
| Armrests | External armrests | Short | Powder-coated aluminium | ARM-EX-S-③ | 217 | 217 | 217 |
| | | | Polished aluminium | ARM-EX-S-POL | 244 | 244 | 244 |
| | | | Black polyurethane (PU) | ARM-EX-S-KB | 223 | 223 | 223 |
| | | Long | Powder-coated aluminium | ARM-EX-L-③ | 217 | 217 | 217 |
| | | | Polished aluminium | ARM-EX-L-POL | 244 | 244 | 244 |
| | | | Black polyurethane (PU) | ARM-EX-L-KB | 223 | 223 | 223 |
| | Internal armrests | Short | Powder-coated aluminium | ARM-IN-S-③ | 109 | 217 | 326 |
| | | | Polished aluminium | ARM-IN-S-POL | 122 | 244 | 366 |
| | | | Black polyurethane (PU) | ARM-IN-S-KB | 112 | 223 | 334 |
| | | Long | Powder-coated aluminium | ARM-IN-L-③ | 109 | 217 | 326 |
| | | | Polished aluminium | ARM-IN-L-POL | 122 | 244 | 366 |
| | | | Black polyurethane (PU) | ARM-IN-L-KB | 112 | 223 | 334 |
| | External and internal armrests | Short | Powder-coated aluminium | ARM-EI-S-③ | 326 | 434 | 543 |
| | | | Polished aluminium | ARM-EI-S-POL | 366 | 487 | 609 |
| | | | Black polyurethane (PU) | ARM-EI-S-KB | 334 | 446 | 557 |
| | | Long | Powder-coated aluminium | ARM-EI-L-③ | 326 | 434 | 543 |
| | | | Polished aluminium | ARM-EI-L-POL | 366 | 487 | 609 |
| | | | Black polyurethane (PU) | ARM-EI-L-KB | 334 | 446 | 557 |
| External long, internal short | | Powder-coated aluminium | ARM-EI-LS-③ | 326 | 434 | 543 | |
| | | Polished aluminium | ARM-EI-LS-POL | 366 | 487 | 609 | |
| | | Black polyurethane (PU) | ARM-EI-LS-KB | 334 | 446 | 557 | |

③ – Please specify metal colour code – see finishes

- Available as standard (included in basic price)

| | | | | | 8000 BENCH 2U 4L M | 8000 BENCH 3U 4L M | 8000 BENCH 4U 4L M | |
|---------------|-------------------|------------------------|------|--------------|-----------------------|-----------------------|-----------------------|-------------|
| None | | | | | • | • | • | |
| Media | Quantity | Configuration (9) | | Position (7) | | | | |
| | One media port | 1 × power socket | YKU8 | A, B or C | J1-YKU8-(7)-(8) | 465 | 498 | 540 |
| | | 1 × double USB charger | YKU9 | | J1-YKU9-(7)-(8) | 718 | 751 | 793 |
| | Two media ports | 1 × power socket | YKU8 | A and B | J2-(9)/(9)-(8) | — | 376 / piece | — |
| | | 1 × double USB charger | YKU9 | | | | 629 / piece | — |
| | Three media ports | 1 × power socket | YKU8 | A, B and C | J3-(9)/(9)/(9)-(8) | — | — | 376 / piece |
| | | 1 × double USB charger | YKU9 | | | | 629 / piece | — |
| Glides | Plastic | | | | GD | • | • | • |
| | Plastic with felt | | | | GDF | 20 | 20 | 20 |
| | Plastic nonskid | | | | GDN | 17 | 17 | 17 |

Sample order 8000 BENCH 2U 4L M (E-WK/POL/WK BA-WK SE-WK GD)

(7) – Please specify media port position

(8) – Please specify media port standard: CH23, FR, GB, GE

(9) – Please specify media port configuration

• Available as standard (included in basic price)

Price list

8000 5, 6-seater bench, metal seat and backrest



| | | | | 8000 BENCH 5U 4L M | 8000 BENCH 6U 4L M | |
|-------------------------------|--------------------------------|-------------------------|-------------------------|-----------------------|-----------------------|-----|
| | | | | Basic price (EUR) | | |
| | | | | 3529 | 4053 | |
| Frame | Beam | Seat frame | Legs | | | |
| | Powder-coated | Powder-coated aluminium | Powder-coated aluminium | | • | |
| | | Powder-coated aluminium | Polished aluminium | E-③③③ | 67 | 67 |
| | | Polished aluminium | Powder-coated aluminium | | 233 | 267 |
| | | Polished aluminium | Polished aluminium | | 300 | 334 |
| Backrest | Powder-coated perforated steel | | BA-③ | • | • | |
| Seat | Powder-coated perforated steel | | SE-③ | • | • | |
| | None | | | • | • | |
| Armrests | External armrests | Short | Powder-coated aluminium | ARM-EX-S-③ | 217 | 217 |
| | | | Polished aluminium | ARM-EX-S-POL | 244 | 244 |
| | | | Black polyurethane (PU) | ARM-EX-S-KB | 223 | 223 |
| | | Long | Powder-coated aluminium | ARM-EX-L-③ | 217 | 217 |
| | | | Polished aluminium | ARM-EX-L-POL | 244 | 244 |
| | | | Black polyurethane (PU) | ARM-EX-L-KB | 223 | 223 |
| | Internal armrests | Short | Powder-coated aluminium | ARM-IN-S-③ | 434 | 543 |
| | | | Polished aluminium | ARM-IN-S-POL | 487 | 609 |
| | | | Black polyurethane (PU) | ARM-IN-S-KB | 446 | 557 |
| | | Long | Powder-coated aluminium | ARM-IN-L-③ | 434 | 543 |
| | | | Polished aluminium | ARM-IN-L-POL | 487 | 609 |
| | | | Black polyurethane (PU) | ARM-IN-L-KB | 446 | 557 |
| | External and internal armrests | Short | Powder-coated aluminium | ARM-EI-S-③ | 651 | 760 |
| | | | Polished aluminium | ARM-EI-S-POL | 731 | 852 |
| | | | Black polyurethane (PU) | ARM-EI-S-KB | 668 | 780 |
| | | Long | Powder-coated aluminium | ARM-EI-L-③ | 651 | 760 |
| | | | Polished aluminium | ARM-EI-L-POL | 731 | 852 |
| | | | Black polyurethane (PU) | ARM-EI-L-KB | 668 | 780 |
| External long, internal short | | Powder-coated aluminium | ARM-EI-LS-③ | 651 | 760 | |
| | | Polished aluminium | ARM-EI-LS-POL | 731 | 852 | |
| | | Black polyurethane (PU) | ARM-EI-LS-KB | 668 | 780 | |

③ – Please specify metal colour code – see finishes

• Available as standard (included in basic price)

| | | | | | 8000 BENCH 5U 4L M | 8000 BENCH 6U 4L M |
|---------------------|--|-----------------------------|------------------|--------------------------------|-----------------------|-----------------------|
| None | | | | | • | • |
| | Quantity | Configuration (9) | | Position (7) | | |
| Media | One media port | 1 × power socket YKU8 | A, B, C, D or E | J1-YKU8-(7)-(8) | 582 | 622 |
| | | 1 x double USB charger YKU9 | | J1-YKU9-(7)-(8) | 835 | 875 |
| | Four media ports | 1 × power socket YKU8 | A, B, C and D | J4-(9)/(9)/(9)/ (9)-(8) | 326 / piece | — |
| | | 1 x double USB charger YKU9 | | | 579 / piece | |
| | Five media ports | 1 × power socket YKU8 | A, B, C, D and E | J5-(9)/(9)/(9)/(9)/ (9)-(8) | — | 326 / piece |
| | | 1 x double USB charger YKU9 | | | 579 / piece | |
| Glides | Plastic | | | GD | • | • |
| | Plastic with felt | | | GDF | 30 | 30 |
| | Plastic nonskid | | | GDN | 24 | 24 |
| Sample order | 8000 BENCH 5U 4L M (E-WK/WK/WK BA-WK SE-WK GD) | | | | | |

(7) – Please specify media port position

(8) – Please specify media port standard: CH23, FR, GB, GE

(9) – Please specify media port configuration

• Available as standard (included in basic price)

Price list

8000 2,3,4-seater bench, PU seat, metal backrest

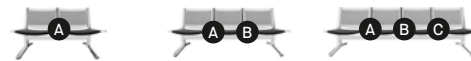

| 8000 BENCH 2U 4L M/P | 8000 BENCH 3U 4L M/P | 8000 BENCH 4U 4L M/P |
|-------------------------|-------------------------|-------------------------|
| Basic price (EUR) | | |
| 1796 | 2363 | 2931 |

| | Beam | Seat frame | Legs | | | | |
|-------------------------------|--------------------------------|-------------------------|-------------------------|------------|-----|-----|-----|
| Frame | Powder-coated | Powder-coated aluminium | Powder-coated aluminium | E-③③③ | • | • | • |
| | | Powder-coated aluminium | Polished aluminium | | 45 | 45 | 45 |
| | | Polished aluminium | Powder-coated aluminium | | 121 | 156 | 191 |
| | | Polished aluminium | Polished aluminium | | 166 | 200 | 235 |
| Backrest | Powder-coated perforated steel | | | BA-③ | • | • | • |
| Seat | Black polyurethane (PU) foam | | | SE-KB | • | • | • |
| | None | | | | • | • | • |
| Armrests | External armrests | Short | Powder-coated aluminium | ARM-EX-S-③ | 217 | 217 | 217 |
| | | | Polished aluminium | | 244 | 244 | 244 |
| | | Long | Black polyurethane (PU) | ARM-EX-L-③ | 223 | 223 | 223 |
| | | | Powder-coated aluminium | | 217 | 217 | 217 |
| | | | Polished aluminium | | 244 | 244 | 244 |
| | | | Black polyurethane (PU) | | 223 | 223 | 223 |
| | Internal armrests | Short | Powder-coated aluminium | ARM-IN-S-③ | 109 | 217 | 326 |
| | | | Polished aluminium | | 122 | 244 | 366 |
| | | Long | Black polyurethane (PU) | ARM-IN-L-③ | 112 | 223 | 334 |
| | | | Powder-coated aluminium | | 109 | 217 | 326 |
| | | | Polished aluminium | | 122 | 244 | 366 |
| | | | Black polyurethane (PU) | | 112 | 223 | 334 |
| | External and internal armrests | Short | Powder-coated aluminium | ARM-EI-S-③ | 326 | 434 | 543 |
| | | | Polished aluminium | | 366 | 487 | 609 |
| | | | Black polyurethane (PU) | | 334 | 446 | 557 |
| | | Long | Powder-coated aluminium | ARM-EI-L-③ | 326 | 434 | 543 |
| Polished aluminium | | | 366 | | 487 | 609 | |
| Black polyurethane (PU) | | | 334 | | 446 | 557 | |
| External long, internal short | | Powder-coated aluminium | ARM-EI-LS-③ | 326 | 434 | 543 | |
| | | Polished aluminium | | 366 | 487 | 609 | |
| | | Black polyurethane (PU) | | 334 | 446 | 557 | |

③ – Please specify metal colour code – see finishes

• Available as standard (included in basic price)

| | | | | | 8000 BENCH 2U 4L M/P | 8000 BENCH 3U 4L M/P | 8000 BENCH 4U 4L M/P | |
|---------------|-------------------|------------------------|------|--------------|-------------------------|-------------------------|-------------------------|-------------|
| None | | | | | • | • | • | |
| Media | Quantity | Configuration (9) | | Position (7) | | | | |
| | One media port | 1 × power socket | YKU8 | A, B or C | J1-YKU8-(7)-(8) | 465 | 498 | 540 |
| | | 1 × double USB charger | YKU9 | | J1-YKU9-(7)-(8) | 718 | 751 | 793 |
| | Two media ports | 1 × power socket | YKU8 | A and B | J2-(9)/(9)-(8) | — | 376 / piece | — |
| | | 1 × double USB charger | YKU9 | | | | 629 / piece | — |
| | Three media ports | 1 × power socket | YKU8 | A, B and C | J3-(9)/(9)/(9)-(8) | — | — | 376 / piece |
| | | 1 × double USB charger | YKU9 | | | | 629 / piece | — |
| Glides | Plastic | | | | GD | • | • | • |
| | Plastic with felt | | | | GDF | 20 | 20 | 20 |
| | Plastic nonskid | | | | GDN | 17 | 17 | 17 |

Sample order 8000 BENCH 2U 4L M/P (E-WK/WK/WK BA-WK SE-KB GD)

- (7) – Please specify media port position
- (8) – Please specify media port standard: CH23, FR, GB, GE
- (9) – Please specify media port configuration
- Available as standard (included in basic price)

Price list

8000 5, 6-seater bench, PU seat, metal backrest



| | | | | 8000 BENCH 5U 4L M/P | 8000 BENCH 6U 4L M/P | | |
|--------------------------------|--------------------------------|-------------------------|-------------------------|-------------------------|-------------------------|-----|-----|
| | | | | Basic price (EUR) | | | |
| | | | | 3714 | 4282 | | |
| Frame | Beam | Seat frame | Legs | | | | |
| | Powder-coated | Powder-coated aluminium | Powder-coated aluminium | | • | • | |
| | | Powder-coated aluminium | Polished aluminium | E-③③③ | 67 | 67 | |
| | | Polished aluminium | Powder-coated aluminium | | 233 | 267 | |
| Polished aluminium | | Polished aluminium | | 300 | 334 | | |
| Backrest | Powder-coated perforated steel | | BA-③ | • | • | | |
| Seat | Black polyurethane (PU) foam | | SE-KB | • | • | | |
| | None | | | • | • | | |
| Armrests | External armrests | Short | Powder-coated aluminium | ARM-EX-S-③ | 217 | 217 | |
| | | | Polished aluminium | | 244 | 244 | |
| | | Long | Black polyurethane (PU) | ARM-EX-S-KB | 223 | 223 | |
| | | | Powder-coated aluminium | | 217 | 217 | |
| | | | Polished aluminium | ARM-EX-L-③ | 244 | 244 | |
| | | | Black polyurethane (PU) | ARM-EX-L-KB | 223 | 223 | |
| | Internal armrests | Short | Powder-coated aluminium | ARM-IN-S-③ | 434 | 543 | |
| | | | Polished aluminium | | 487 | 609 | |
| | | | Black polyurethane (PU) | ARM-IN-S-KB | 446 | 557 | |
| | | Long | Powder-coated aluminium | | 434 | 543 | |
| Polished aluminium | | | ARM-IN-L-③ | 487 | 609 | | |
| Black polyurethane (PU) | | | ARM-IN-L-KB | 446 | 557 | | |
| External and internal armrests | | | Short | Powder-coated aluminium | ARM-EI-S-③ | 651 | 760 |
| | | | | Polished aluminium | | 731 | 852 |
| | Black polyurethane (PU) | ARM-EI-S-KB | | 668 | 780 | | |
| | Long | Powder-coated aluminium | | 651 | 760 | | |
| | | Polished aluminium | ARM-EI-L-③ | 731 | 852 | | |
| External long, internal short | Black polyurethane (PU) | ARM-EI-L-KB | 668 | 780 | | | |
| | | Powder-coated aluminium | ARM-EI-LS-③ | 651 | 760 | | |
| | | Polished aluminium | | 731 | 852 | | |
| | | Black polyurethane (PU) | ARM-EI-LS-KB | 668 | 780 | | |

③ – Please specify metal colour code – see finishes

- Available as standard (included in basic price)



| | | | | | 8000 BENCH 5U 4L M/P | 8000 BENCH 6U 4L M/P | |
|---------------|-------------------|------------------------|------|------------------|--------------------------------|-------------------------|-------------|
| None | | | | | • | • | |
| Media | Quantity | Configuration (9) | | Position (7) | | | |
| | One media port | 1 × power socket | YKU8 | A, B, C, D or E | J1-YKU8-(7)-(8) | 582 | 622 |
| | | 1 × double USB charger | YKU9 | | J1-YKU9-(7)-(8) | 835 | 875 |
| | Four media ports | 1 × power socket | YKU8 | A, B, C and D | J4-(9)/(9)/(9)/ (9)-(8) | 326 / piece | — |
| | | 1 × double USB charger | YKU9 | | | 579 / piece | |
| | Five media ports | 1 × power socket | YKU8 | A, B, C, D and E | J5-(9)/(9)/(9)/(9)/ (9)-(8) | — | 326 / piece |
| | | 1 × double USB charger | YKU9 | | | 579 / piece | |
| Glides | Plastic | | | GD | • | • | |
| | Plastic with felt | | | GDF | 30 | 30 | |
| | Plastic nonskid | | | GDN | 24 | 24 | |

Sample order 8000 BENCH 5U 4L M/P (E-WK/WK/WK BA-WK SE-KB GD)

- (7) – Please specify media port position
- (8) – Please specify media port standard: CH23, FR, GB, GE
- (9) – Please specify media port configuration
- Available as standard (included in basic price)

Price list

8000 2,3,4-seater bench, PU seat and backrest

| | | | |  |  |  | |
|-------------------------------|--------------------------------|-------------------------|-------------------------|--|---|---|-----|
| | | | | 8000 BENCH 2U 4L P | 8000 BENCH 3U 4L P | 8000 BENCH 4U 4L P | |
| | | | | Basic price (EUR) | | | |
| | | | | 1872 | 2497 | 3120 | |
| Frame | Beam | Seat frame | Legs | | | | |
| | Powder-coated | Powder-coated aluminium | Powder-coated aluminium | • | • | • | |
| | | Powder-coated aluminium | Polished aluminium | E-③③③ | 45 | 45 | 45 |
| | | Polished aluminium | Powder-coated aluminium | | 121 | 156 | 191 |
| | | Polished aluminium | Polished aluminium | | 166 | 200 | 235 |
| Backrest | Black polyurethane (PU) foam | BA-KB | • | • | • | | |
| Seat | Black polyurethane (PU) foam | SE-KB | • | • | • | | |
| | None | | • | • | • | | |
| Armrests | External armrests | Short | Powder-coated aluminium | ARM-EX-S-③ | 217 | 217 | 217 |
| | | | Polished aluminium | | 244 | 244 | 244 |
| | | Long | Black polyurethane (PU) | ARM-EX-S-KB | 223 | 223 | 223 |
| | | | Powder-coated aluminium | ARM-EX-L-③ | 217 | 217 | 217 |
| | | | Polished aluminium | | 244 | 244 | 244 |
| | | | Black polyurethane (PU) | ARM-EX-L-KB | 223 | 223 | 223 |
| | Internal armrests | Short | Powder-coated aluminium | ARM-IN-S-③ | 109 | 217 | 326 |
| | | | Polished aluminium | | 122 | 244 | 366 |
| | | Long | Black polyurethane (PU) | ARM-IN-S-KB | 112 | 223 | 334 |
| | | | Powder-coated aluminium | ARM-IN-L-③ | 109 | 217 | 326 |
| | | | Polished aluminium | | 122 | 244 | 366 |
| | | | Black polyurethane (PU) | ARM-IN-L-KB | 112 | 223 | 334 |
| | External and internal armrests | Short | Powder-coated aluminium | ARM-EI-S-③ | 326 | 434 | 543 |
| | | | Polished aluminium | | 366 | 487 | 609 |
| | | Long | Black polyurethane (PU) | ARM-EI-S-KB | 334 | 446 | 557 |
| | | | Powder-coated aluminium | ARM-EI-L-③ | 326 | 434 | 543 |
| | | | Polished aluminium | | 366 | 487 | 609 |
| | | | Black polyurethane (PU) | ARM-EI-L-KB | 334 | 446 | 557 |
| External long, internal short | | Powder-coated aluminium | ARM-EI-LS-③ | 326 | 434 | 543 | |
| | | Polished aluminium | | 366 | 487 | 609 | |
| | | Black polyurethane (PU) | ARM-EI-LS-KB | 334 | 446 | 557 | |

③ – Please specify metal colour code – see finishes

• Available as standard (included in basic price)

| | | | | | 8000 BENCH 2U 4L P | 8000 BENCH 3U 4L P | 8000 BENCH 4U 4L P | |
|---------------|-------------------|------------------------|------|--------------|-----------------------|-----------------------|-----------------------|-------------|
| None | | | | | • | • | • | |
| Media | Quantity | Configuration (9) | | Position (7) | | | | |
| | One media port | 1 × power socket | YKU8 | A, B or C | J1-YKU8-(7)-(8) | 465 | 498 | 540 |
| | | 1 × double USB charger | YKU9 | | J1-YKU9-(7)-(8) | 718 | 751 | 793 |
| | Two media ports | 1 × power socket | YKU8 | A and B | J2-(9)/(9)-(8) | — | 376 / piece | — |
| | | 1 × double USB charger | YKU9 | | | | 629 / piece | |
| | Three media ports | 1 × power socket | YKU8 | A, B and C | J3-(9)/(9)/(9)-(8) | — | — | 376 / piece |
| | | 1 × double USB charger | YKU9 | | | | | 629 / piece |
| Glides | Plastic | | | | GD | • | • | • |
| | Plastic with felt | | | | GDF | 20 | 20 | 20 |
| | Plastic nonskid | | | | GDN | 17 | 17 | 17 |

Sample order 8000 BENCH 2U 4L P (E-WK/WK/WK BA-KB SE-KB GD)

(7) – Please specify media port position

(8) – Please specify media port standard: CH23, FR, GB, GE

(9) – Please specify media port configuration

• Available as standard (included in basic price)

Price list

8000 5, 6-seater bench, PU seat and backrest



| | | | | 8000 BENCH 5U 4L P | 8000 BENCH 6U 4L P | |
|-------------------------------|--------------------------------|-------------------------|-------------------------|-----------------------|-----------------------|-----|
| | | | | Basic price (EUR) | | |
| | | | | 3960 | 4584 | |
| Frame | Beam | Seat frame | Legs | | | |
| | Powder-coated | Powder-coated aluminium | Powder-coated aluminium | | • | |
| | | Powder-coated aluminium | Polished aluminium | E-③③③ | 67 | 67 |
| | | Polished aluminium | Powder-coated aluminium | | 233 | 267 |
| | | Polished aluminium | Polished aluminium | | 300 | 334 |
| Backrest | Black polyurethane (PU) foam | | BA-KB | • | • | |
| Seat | Black polyurethane (PU) foam | | SE-KB | • | • | |
| | None | | | • | • | |
| Armrests | External armrests | Short | Powder-coated aluminium | | 217 | 217 |
| | | | Polished aluminium | ARM-EX-S-③ | 244 | 244 |
| | | | Black polyurethane (PU) | ARM-EX-S-KB | 223 | 223 |
| | | Long | Powder-coated aluminium | | 217 | 217 |
| | | | Polished aluminium | ARM-EX-L-③ | 244 | 244 |
| | | | Black polyurethane (PU) | ARM-EX-L-KB | 223 | 223 |
| | Internal armrests | Short | Powder-coated aluminium | | 434 | 543 |
| | | | Polished aluminium | ARM-IN-S-③ | 487 | 609 |
| | | | Black polyurethane (PU) | ARM-IN-S-KB | 446 | 557 |
| | | Long | Powder-coated aluminium | | 434 | 543 |
| | | | Polished aluminium | ARM-IN-L-③ | 487 | 609 |
| | | | Black polyurethane (PU) | ARM-IN-L-KB | 446 | 557 |
| | External and internal armrests | Short | Powder-coated aluminium | | 651 | 760 |
| | | | Polished aluminium | ARM-EI-S-③ | 731 | 852 |
| | | | Black polyurethane (PU) | ARM-EI-S-KB | 668 | 780 |
| | | Long | Powder-coated aluminium | | 651 | 760 |
| | | | Polished aluminium | ARM-EI-L-③ | 731 | 852 |
| | | | Black polyurethane (PU) | ARM-EI-L-KB | 668 | 780 |
| External long, internal short | | Powder-coated aluminium | | 651 | 760 | |
| | | Polished aluminium | ARM-EI-LS-③ | 731 | 852 | |
| | | Black polyurethane (PU) | ARM-EI-LS-KB | 668 | 780 | |

③ – Please specify metal colour code – see finishes

• Available as standard (included in basic price)

| | | | | | 8000 BENCH 5U 4L P | 8000 BENCH 6U 4L P | |
|---------------|-------------------|------------------------|------|------------------|--------------------------------|-----------------------|-------------|
| None | | | | | • | • | |
| Media | Quantity | Configuration ((9)) | | Position ((7)) | | | |
| | One media port | 1 × power socket | YKU8 | A, B, C, D or E | J1-YKU8-(7)-(8) | 582 | 622 |
| | | 1 × double USB charger | YKU9 | | J1-YKU9-(7)-(8) | 835 | 875 |
| | Four media ports | 1 × power socket | YKU8 | A, B, C and D | J4-(9)/(9)/(9)/ (9)-(8) | 326 / piece | — |
| | | 1 × double USB charger | YKU9 | | | 579 / piece | |
| | Five media ports | 1 × power socket | YKU8 | A, B, C, D and E | J5-(9)/(9)/(9)/(9)/ (9)-(8) | — | 326 / piece |
| | | 1 × double USB charger | YKU9 | | | | 579 / piece |
| Glides | Plastic | | | GD | • | • | |
| | Plastic with felt | | | GDF | 30 | 30 | |
| | Plastic nonskid | | | GDN | 24 | 24 | |

Sample order 8000 BENCH 5U 4L P (E-WK/WK/WK BA-KB SE-KB GD)

(7) – Please specify media port position

(8) – Please specify media port standard: CH23, FR, GB, GE

(9) – Please specify media port configuration

• Available as standard (included in basic price)

Price list

8000 2,3,4-seater bench, upholstered seat and backrest



8000 BENCH 2U 4L UPH 8000 BENCH 3U 4L UPH 8000 BENCH 4U 4L UPH

Basic price (EUR)
according to upholstery price group

| | | | |
|---------------|------|------|------|
| Price group 4 | 2312 | 3148 | 3986 |
| Price group 6 | 2776 | 3845 | 4917 |

| | Beam | Seat frame | Legs | | | | |
|--------------------|-----------------------------------|-------------------------|-------------------------|---------|-----|-----|-----|
| Frame | Powder-coated | Powder-coated aluminium | Powder-coated aluminium | E-③③③ | • | • | • |
| | | Powder-coated aluminium | Polished aluminium | | 45 | 45 | 45 |
| | | Polished aluminium | Powder-coated aluminium | | 121 | 156 | 191 |
| | | Polished aluminium | Polished aluminium | | 166 | 200 | 235 |
| Backrest | Upholstered | | BA-⑤ | • | • | • | |
| Seat | Upholstered | | SE-⑤ | • | • | • | |
| Raised seat | No raised seat | | | | | | |
| | Raised seat in position A | | | SS-R-A | 170 | 170 | 170 |
| | Raised seat in position B | | | SS-R-B | 170 | — | — |
| | Raised seat in position C | | | SS-R-C | — | 170 | — |
| | Raised seat in position D | | | SS-R-D | — | — | 170 |
| | Raised seats in positions A and B | | | SS-R-AB | — | — | 340 |
| | Raised seats in positions C and D | | | SS-R-CD | — | — | 340 |

③ – Please specify metal colour code – [see finishes](#)

⑤ – Please specify upholstery colour code from selected price group – [see finishes](#)

• Available as standard (included in basic price)

| | | | | 8000 BENCH 2U 4L UPH | 8000 BENCH 3U 4L UPH | 8000 BENCH 4U 4L UPH | | |
|---|--|---------------------------|-------------------------|-------------------------|-------------------------|-------------------------|-------------|-------------|
| Armrests | None | | | • | • | • | | |
| | External armrests | Short | Powder-coated aluminium | ARM-EX-S-③ | 217 | 217 | 217 | |
| | | | Polished aluminium | | 244 | 244 | 244 | |
| | | | Black polyurethane (PU) | ARM-EX-S-KB | 223 | 223 | 223 | |
| | | Long | Powder-coated aluminium | ARM-EX-L-③ | 217 | 217 | 217 | |
| | | | Polished aluminium | | 244 | 244 | 244 | |
| | | | Black polyurethane (PU) | ARM-EX-L-KB | 223 | 223 | 223 | |
| | Internal armrests | Short | Powder-coated aluminium | ARM-IN-S-③ | 109 | 217 | 326 | |
| | | | Polished aluminium | | 122 | 244 | 366 | |
| | | | Black polyurethane (PU) | ARM-IN-S-KB | 112 | 223 | 334 | |
| | | Long | Powder-coated aluminium | ARM-IN-L-③ | 109 | 217 | 326 | |
| | | | Polished aluminium | | 122 | 244 | 366 | |
| | | | Black polyurethane (PU) | ARM-IN-L-KB | 112 | 223 | 334 | |
| | External and internal armrests | Short | Powder-coated aluminium | ARM-EI-S-③ | 326 | 434 | 543 | |
| | | | Polished aluminium | | 366 | 487 | 609 | |
| | | | Black polyurethane (PU) | ARM-EI-S-KB | 334 | 446 | 557 | |
| | | Long | Powder-coated aluminium | ARM-EI-L-③ | 326 | 434 | 543 | |
| | | | Polished aluminium | | 366 | 487 | 609 | |
| | | | Black polyurethane (PU) | ARM-EI-L-KB | 334 | 446 | 557 | |
| | External long, internal short | Powder-coated aluminium | ARM-EI-LS-③ | 326 | 434 | 543 | | |
| Polished aluminium | | | 366 | 487 | 609 | | | |
| Black polyurethane (PU) | | ARM-EI-LS-KB | 334 | 446 | 557 | | | |
| Media | None | | | • | • | • | | |
| | Quantity | Configuration (⑨) | Position (⑦) | | | | | |
| | One media port | 1 × power socket | YKU8 | A, B or C | J1-YKU8-⑦-⑧ | 465 | 498 | 540 |
| | | 1 × double USB charger | YKU9 | | J1-YKU9-⑦-⑧ | 718 | 751 | 793 |
| | Two media ports | 1 × power socket | YKU8 | A and B | J2-⑨/⑨-⑧ | — | 376 / piece | — |
| | | 1 × double USB charger | YKU9 | | | | 629 / piece | |
| | Three media ports | 1 × power socket | YKU8 | A, B and C | J3-⑨/⑨/⑨-⑧ | — | — | 376 / piece |
| | | 1 × double USB charger | YKU9 | | | | 629 / piece | |
| | Glides | Plastic | | | GD | • | • | • |
| | | Plastic with felt | | | GDF | 20 | 20 | 20 |
| Plastic nonskid | | | GDN | 17 | 17 | 17 | | |
| Foam | Standard foam | | | FSTD | • | • | • | |
| | Flame retardant foam | | | FFR2 | 58 | 86 | 115 | |
| | Flame retardant foam with fireproof fabric | | | FFRF | 365 | 546 | 727 | |
| Wood and wood- based materials | Raw material from certified forests, FSC certificate – authorized companies | | | FSC | • | • | • | |
| Sample order | 8000 BENCH 2U 4L UPH (E-WK/WK/WK BA-NF705 SE-NF705 GD FSTD FSC) | | | | | | | |

③ – Please specify metal colour code – [see finishes](#)

⑦ – Please specify media port position

⑧ – Please specify media port standard: CH23, FR, GB, GE

⑨ – Please specify media port configuration

• Available as standard (included in basic price)

Price list

8000 5, 6-seater bench, upholstered seat and backrest



8000 BENCH 5U
4L UPH

8000 BENCH 6U
4L UPH

Basic price (EUR)
according to upholstery price group

| | | |
|---------------|------|------|
| Price group 4 | 5029 | 5867 |
| Price group 6 | 6191 | 7263 |

| | Beam | Seat frame | Legs | | | |
|--------------------|-----------------------------------|-------------------------|-------------------------|---------|-----|-----|
| Frame | Powder-coated | Powder-coated aluminium | Powder-coated aluminium | E-③③③ | • | • |
| | | Powder-coated aluminium | Polished aluminium | | 67 | 67 |
| | | Polished aluminium | Powder-coated aluminium | | 233 | 267 |
| | | Polished aluminium | Polished aluminium | | 300 | 334 |
| Backrest | Upholstered | | | BA-⑤ | • | • |
| Seat | Upholstered | | | SE-⑤ | • | • |
| Raised seat | No raised seat | | | | • | • |
| | Raised seat in position A | | | SS-R-A | 170 | 170 |
| | Raised seat in position E | | | SS-R-B | 170 | |
| | Raised seats in positions A and B | | | SS-R-AB | 340 | – |
| | Raised seats in positions D and E | | | SS-R-DE | 340 | |
| | Raised seat in position F | | | SS-R-F | | 170 |
| | Raised seats in positions E and F | | | SS-R-EF | – | 340 |

③ – Please specify metal colour code – [see finishes](#)

⑤ – Please specify upholstery colour code from selected price group – [see finishes](#)

• Available as standard (included in basic price)

| | | | | 8000 BENCH 5U 4L UPH | 8000 BENCH 6U 4L UPH | | |
|---|--|---------------------------|-------------------------|-------------------------|-------------------------|-------------|-------------|
| Armrests | None | | | • | • | | |
| | External armrests | Short | Powder-coated aluminium | ARM-EX-S-③ | 217 | 217 | |
| | | | Polished aluminium | | 244 | 244 | |
| | | | Black polyurethane (PU) | ARM-EX-S-KB | 223 | 223 | |
| | | Long | Powder-coated aluminium | ARM-EX-L-③ | 217 | 217 | |
| | | | Polished aluminium | | 244 | 244 | |
| | | | Black polyurethane (PU) | ARM-EX-L-KB | 223 | 223 | |
| | Internal armrests | Short | Powder-coated aluminium | ARM-IN-S-③ | 434 | 543 | |
| | | | Polished aluminium | | 487 | 609 | |
| | | | Black polyurethane (PU) | ARM-IN-S-KB | 446 | 557 | |
| | | Long | Powder-coated aluminium | ARM-IN-L-③ | 434 | 543 | |
| | | | Polished aluminium | | 487 | 609 | |
| | | | Black polyurethane (PU) | ARM-IN-L-KB | 446 | 557 | |
| | External and internal armrests | Short | Powder-coated aluminium | ARM-EI-S-③ | 651 | 760 | |
| | | | Polished aluminium | | 731 | 852 | |
| | | | Black polyurethane (PU) | ARM-EI-S-KB | 668 | 780 | |
| | | Long | Powder-coated aluminium | ARM-EI-L-③ | 651 | 760 | |
| | | | Polished aluminium | | 731 | 852 | |
| | | | Black polyurethane (PU) | ARM-EI-L-KB | 668 | 780 | |
| | External long, internal short | Powder-coated aluminium | ARM-EI-LS-③ | 651 | 760 | | |
| Polished aluminium | | | 731 | 852 | | | |
| Black polyurethane (PU) | | ARM-EI-LS-KB | 668 | 780 | | | |
| Media | None | | | • | • | | |
| | Quantity | Configuration (⑨) | Position (⑦) | | | | |
| | One media port | 1 × power socket | YKU8 | A, B, C, D or E | J1-YKU8-⑦-⑧ | 582 | 622 |
| | | 1 × double USB charger | YKU9 | | J1-YKU9-⑦-⑧ | 835 | 875 |
| | Four media ports | 1 × power socket | YKU8 | A, B, C and D | J4-⑨/⑨/⑨/ ⑨-⑧ | 326 / piece | — |
| | | 1 × double USB charger | YKU9 | | | 579 / piece | |
| | Five media ports | 1 × power socket | YKU8 | A, B, C, D and E | J5-⑨/⑨/⑨/⑨/ ⑨-⑧ | — | 326 / piece |
| | | 1 × double USB charger | YKU9 | | | 579 / piece | |
| | Glides | Plastic | | | GD | • | • |
| | | Plastic with felt | | | GDF | 30 | 30 |
| Plastic nonskid | | | GDN | 24 | 24 | | |
| Foam | Standard foam | | | FSTD | • | • | |
| | Flame retardant foam | | | FFR2 | 144 | 172 | |
| | Flame retardant foam with fireproof fabric | | | FFRF | 910 | 1091 | |
| Wood and wood- based materials | Raw material from certified forests, FSC certificate – authorized companies | | | FSC | • | • | |
| Sample order | 8000 BENCH 5U 4L UPH (E-WK/WK/WK BA-NF705 SE-NF705 GD FSTD FSC) | | | | | | |

③ – Please specify metal colour code – [see finishes](#)

⑦ – Please specify media port position

⑧ – Please specify media port standard: CH23, FR, GB, GE

⑨ – Please specify media port configuration

• Available as standard (included in basic price)

Price list

8000 2,3,4-seater bench with table top, metal seat and backrest



| 8000 BENCH 2U 4LT M | 8000 BENCH 3U 4LT M | 8000 BENCH 4U 4LT M |
|------------------------|------------------------|------------------------|
|------------------------|------------------------|------------------------|

Basic price (EUR)

| 2002 | 2527 | 3049 |
|------|------|------|
|------|------|------|

| | Beam | Seat frame | Legs | | | | |
|-------------------------------|--------------------------------|-------------------------|-------------------------|--------------|-----|-----|-----|
| Frame | Powder-coated | Powder-coated aluminium | Powder-coated aluminium | E-③③③ | • | • | • |
| | | Powder-coated aluminium | Polished aluminium | | 45 | 45 | 45 |
| | | Polished aluminium | Powder-coated aluminium | | 121 | 156 | 191 |
| | | Polished aluminium | Polished aluminium | | 166 | 200 | 235 |
| Backrest | Powder-coated perforated steel | | BA-③ | • | • | • | |
| Seat | Powder-coated perforated steel | | SE-③ | • | • | • | |
| | None | | | • | • | • | |
| Armrests | External armrests | Short | Powder-coated aluminium | ARM-EX-S-③ | 217 | 217 | 217 |
| | | | Polished aluminium | ARM-EX-S-POL | 244 | 244 | 244 |
| | | | Black polyurethane (PU) | ARM-EX-S-KB | 223 | 223 | 223 |
| | | Long | Powder-coated aluminium | ARM-EX-L-③ | 217 | 217 | 217 |
| | | | Polished aluminium | ARM-EX-L-POL | 244 | 244 | 244 |
| | | | Black polyurethane (PU) | ARM-EX-L-KB | 223 | 223 | 223 |
| | Internal armrests | Short | Powder-coated aluminium | ARM-IN-S-③ | 109 | 217 | 326 |
| | | | Polished aluminium | ARM-IN-S-POL | 122 | 244 | 366 |
| | | | Black polyurethane (PU) | ARM-IN-S-KB | 112 | 223 | 334 |
| | | Long | Powder-coated aluminium | ARM-IN-L-③ | 109 | 217 | 326 |
| | | | Polished aluminium | ARM-IN-L-POL | 122 | 244 | 366 |
| | | | Black polyurethane (PU) | ARM-IN-L-KB | 112 | 223 | 334 |
| | External and internal armrests | Short | Powder-coated aluminium | ARM-EI-S-③ | 326 | 434 | 543 |
| | | | Polished aluminium | ARM-EI-S-POL | 366 | 487 | 609 |
| | | | Black polyurethane (PU) | ARM-EI-S-KB | 334 | 446 | 557 |
| | | Long | Powder-coated aluminium | ARM-EI-L-③ | 326 | 434 | 543 |
| | | | Polished aluminium | ARM-EI-L-POL | 366 | 487 | 609 |
| | | | Black polyurethane (PU) | ARM-EI-L-KB | 334 | 446 | 557 |
| External long, internal short | | Powder-coated aluminium | ARM-EI-LS-③ | 326 | 434 | 543 | |
| | | Polished aluminium | ARM-EI-LS-POL | 366 | 487 | 609 | |
| | | Black polyurethane (PU) | ARM-EI-LS-KB | 334 | 446 | 557 | |

③ – Please specify metal colour code – see finishes

• Available as standard (included in basic price)

| | | | | | 8000 BENCH 2U 4LT M | 8000 BENCH 3U 4LT M | 8000 BENCH 4U 4LT M | |
|---|--|---------------------------|-------------------------|-------------|------------------------|------------------------|------------------------|-------------|
| Top | Top position | Top finish (①) | Support (③) | | | | | |
| | Left | Resopal traceless | Powder-coated aluminium | TF-L-①/③ | • | • | • | |
| | | | Polished aluminium | TF-L-①/POL | 49 | 49 | 49 | |
| | Right | | Powder-coated aluminium | TF-R-①/③ | ○ | ○ | ○ | |
| | | | Polished aluminium | TF-R-①/POL | 49 | 49 | 49 | |
| | Left and right | | Powder-coated aluminium | TF-LR-①/③ | 249 | 249 | 249 | |
| | | | Polished aluminium | TF-LR-①/POL | 345 | 345 | 345 | |
| None | | | | | • | • | • | |
| Media | Quantity | Configuration (⑨) | Position (⑦) | | | | | |
| | One media port | 1 × power socket | YKU8 | A, B or C | J1-YKU8-⑦-⑧ | 465 | 498 | 540 |
| | | 1 × double USB charger | YKU9 | | J1-YKU9-⑦-⑧ | 718 | 751 | 793 |
| | Two media ports | 1 × power socket | YKU8 | A and B | J2-⑨/⑨-⑧ | — | 376 / piece | — |
| | | 1 × double USB charger | YKU9 | | | | 629 / piece | |
| | Three media ports | 1 × power socket | YKU8 | A, B and C | J3-⑨/⑨/⑨-⑧ | — | — | 376 / piece |
| | | 1 × double USB charger | YKU9 | | | | | 629 / piece |
| Glides | Plastic | | | GD | • | • | • | |
| | Plastic with felt | | | GDF | 20 | 20 | 20 | |
| | Plastic nonskid | | | GDN | 17 | 17 | 17 | |
| Wood and wood- based materials | Raw material – EU timber regulation, from certified forests, FSC certificate – authorized companies | | | FSCMIX | • | • | • | |
| Sample order | 8000 BENCH 2U 4LT M (E-WK/WK/WK BA-WK SE-WK TF-L-U0901TP/WK GD FSCMIX) | | | | | | | |

① – Please specify wood colour code – [see finishes](#)

③ – Please specify metal colour code – [see finishes](#)

⑦ – Please specify media port position

⑧ – Please specify media port standard: CH23, FR, GB, GE

⑨ – Please specify media port configuration

• Available as standard (included in basic price)

○ Available as an option (included in basic price)

Price list

8000 5, 6-seater bench with table top, metal seat and backrest



| | | | | 8000 BENCH 5U 4LT M | 8000 BENCH 6U 4LT M | |
|-------------------------------|--------------------------------|-------------------------|-------------------------|------------------------|------------------------|-----|
| | | | | Basic price (EUR) | | |
| | | | | 3798 | 4320 | |
| Frame | Beam | Seat frame | Legs | | | |
| | Powder-coated | Powder-coated aluminium | Powder-coated aluminium | | • | |
| | | Powder-coated aluminium | Polished aluminium | E-③③③ | 67 | 67 |
| | | Polished aluminium | Powder-coated aluminium | | 233 | 267 |
| | | Polished aluminium | Polished aluminium | | 300 | 334 |
| Backrest | Powder-coated perforated steel | | BA-③ | • | • | |
| Seat | Powder-coated perforated steel | | SE-③ | • | • | |
| | None | | | • | • | |
| Armrests | External armrests | Short | Powder-coated aluminium | ARM-EX-S-③ | 217 | 217 |
| | | | Polished aluminium | ARM-EX-S-POL | 244 | 244 |
| | | | Black polyurethane (PU) | ARM-EX-S-KB | 223 | 223 |
| | | Long | Powder-coated aluminium | ARM-EX-L-③ | 217 | 217 |
| | | | Polished aluminium | ARM-EX-L-POL | 244 | 244 |
| | | | Black polyurethane (PU) | ARM-EX-L-KB | 223 | 223 |
| | Internal armrests | Short | Powder-coated aluminium | ARM-IN-S-③ | 434 | 543 |
| | | | Polished aluminium | ARM-IN-S-POL | 487 | 609 |
| | | | Black polyurethane (PU) | ARM-IN-S-KB | 446 | 557 |
| | | Long | Powder-coated aluminium | ARM-IN-L-③ | 434 | 543 |
| | | | Polished aluminium | ARM-IN-L-POL | 487 | 609 |
| | | | Black polyurethane (PU) | ARM-IN-L-KB | 446 | 557 |
| | External and internal armrests | Short | Powder-coated aluminium | ARM-EI-S-③ | 651 | 760 |
| | | | Polished aluminium | ARM-EI-S-POL | 731 | 852 |
| | | | Black polyurethane (PU) | ARM-EI-S-KB | 668 | 780 |
| | | Long | Powder-coated aluminium | ARM-EI-L-③ | 651 | 760 |
| | | | Polished aluminium | ARM-EI-L-POL | 731 | 852 |
| | | | Black polyurethane (PU) | ARM-EI-L-KB | 668 | 780 |
| External long, internal short | | Powder-coated aluminium | ARM-EI-LS-③ | 651 | 760 | |
| | | Polished aluminium | ARM-EI-LS-POL | 731 | 852 | |
| | | Black polyurethane (PU) | ARM-EI-LS-KB | 668 | 780 | |

③ – Please specify metal colour code – [see finishes](#)

• Available as standard (included in basic price)

| | | | | | 8000 BENCH 5U 4LT M | 8000 BENCH 6U 4LT M | |
|--------------------------------------|---|------------------------|-------------------------|---------------------|------------------------|------------------------|-------------|
| Top | Top position | Top finish (①) | Support (③) | | | | |
| | Left | Resopal traceless | Powder-coated aluminium | TF-L-①/③ | • | • | |
| | | | Polished aluminium | TF-L-①/POL | 49 | 49 | |
| | Right | | Powder-coated aluminium | TF-R-①/③ | ○ | ○ | |
| | | | Polished aluminium | TF-R-①/POL | 49 | 49 | |
| | Left and right | | Powder-coated aluminium | TF-LR-①/③ | 249 | 249 | |
| | | | Polished aluminium | TF-LR-①/POL | 345 | 345 | |
| None | | | | | • | • | |
| Media | Quantity | Configuration (⑨) | Position (⑦) | | | | |
| | One media port | 1 × power socket | YKU8 | A, B, C, D or E | J1-YKU8-⑦-⑧ | 582 | 622 |
| | | 1 × double USB charger | YKU9 | | J1-YKU9-⑦-⑧ | 835 | 875 |
| | Four media ports | 1 × power socket | YKU8 | A, B, C and D | J4-⑨/⑨/⑨/ ⑨-⑧ | 326 / piece | — |
| | | 1 × double USB charger | YKU9 | | | 579 / piece | |
| | Five media ports | 1 × power socket | YKU8 | A, B, C, D and E | J5-⑨/⑨/⑨/⑨/ ⑨-⑧ | — | 326 / piece |
| | | 1 × double USB charger | YKU9 | | | 579 / piece | |
| Glides | Plastic | | | GD | • | • | |
| | Plastic with felt | | | GDF | 30 | 30 | |
| | Plastic nonskid | | | GDN | 24 | 24 | |
| Wood and wood-based materials | Raw material – EU timber regulation, from certified forests, FSC certificate – authorized companies | | | FSCMIX | • | • | |
| Sample order | 8000 BENCH 5U 4LT M (E-WK/WK/WK BA-WK SE-WK TF-L-UO901TP/WK GD FSCMIX) | | | | | | |

① – Please specify wood colour code – [see finishes](#)

③ – Please specify metal colour code – [see finishes](#)

⑦ – Please specify media port position

⑧ – Please specify media port standard: CH23, FR, GB, GE

⑨ – Please specify media port configuration

• Available as standard (included in basic price)

○ Available as an option (included in basic price)

Price list

8000 2,3,4-seater bench with table top, PU seat, metal backrest

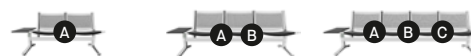

| | | | | 8000 BENCH 2U 4LT M/P | 8000 BENCH 3U 4LT M/P | 8000 BENCH 4U 4LT M/P | |
|-------------------------------|--------------------------------|-------------------------|-------------------------|--------------------------|--------------------------|--------------------------|-----|
| | | | | Basic price (EUR) | | | |
| | | | | 2053 | 2621 | 3190- | |
| Frame | Beam | Seat frame | Legs | | | | |
| | Powder-coated | Powder-coated aluminium | Powder-coated aluminium | • | • | • | |
| | | Powder-coated aluminium | Polished aluminium | E-③③③ | 45 | 45 | 45 |
| | | Polished aluminium | Powder-coated aluminium | | 121 | 156 | 191 |
| | | Polished aluminium | Polished aluminium | | 166 | 200 | 235 |
| Backrest | Powder-coated perforated steel | | BA-③ | • | • | • | |
| Seat | Black polyurethane (PU) foam | | SE-KB | • | • | • | |
| | None | | | • | • | • | |
| Armrests | External armrests | Short | Powder-coated aluminium | ARM-EX-S-③ | 217 | 217 | 217 |
| | | | Polished aluminium | ARM-EX-S-POL | 244 | 244 | 244 |
| | | | Black polyurethane (PU) | ARM-EX-S-KB | 223 | 223 | 223 |
| | | Long | Powder-coated aluminium | ARM-EX-L-③ | 217 | 217 | 217 |
| | | | Polished aluminium | ARM-EX-L-POL | 244 | 244 | 244 |
| | | | Black polyurethane (PU) | ARM-EX-L-KB | 223 | 223 | 223 |
| | Internal armrests | Short | Powder-coated aluminium | ARM-IN-S-③ | 109 | 217 | 326 |
| | | | Polished aluminium | ARM-IN-S-POL | 122 | 244 | 366 |
| | | | Black polyurethane (PU) | ARM-IN-S-KB | 112 | 223 | 334 |
| | | Long | Powder-coated aluminium | ARM-IN-L-③ | 109 | 217 | 326 |
| | | | Polished aluminium | ARM-IN-L-POL | 122 | 244 | 366 |
| | | | Black polyurethane (PU) | ARM-IN-L-KB | 112 | 223 | 334 |
| | External and internal armrests | Short | Powder-coated aluminium | ARM-EI-S-③ | 326 | 434 | 543 |
| | | | Polished aluminium | ARM-EI-S-POL | 366 | 487 | 609 |
| | | | Black polyurethane (PU) | ARM-EI-S-KB | 334 | 446 | 557 |
| | | Long | Powder-coated aluminium | ARM-EI-L-③ | 326 | 434 | 543 |
| | | | Polished aluminium | ARM-EI-L-POL | 366 | 487 | 609 |
| | | | Black polyurethane (PU) | ARM-EI-L-KB | 334 | 446 | 557 |
| External long, internal short | | Powder-coated aluminium | ARM-EI-LS-③ | 326 | 434 | 543 | |
| | | Polished aluminium | ARM-EI-LS-POL | 366 | 487 | 609 | |
| | | Black polyurethane (PU) | ARM-EI-LS-KB | 334 | 446 | 557 | |

③ – Please specify metal colour code – see finishes

- Available as standard (included in basic price)

| | | | | | 8000 BENCH 2U 4L T M/P | 8000 BENCH 3U 4L T M/P | 8000 BENCH 4U 4L T M/P | |
|---|--|---------------------------|-------------------------|-------------|---------------------------|---------------------------|---------------------------|-------------|
| Top | Top position | Top finish (①) | Support (③) | | | | | |
| | Left | Resopal traceless | Powder-coated aluminium | TF-L-①/③ | • | • | • | |
| | | | Polished aluminium | TF-L-①/POL | 49 | 49 | 49 | |
| | Right | | Powder-coated aluminium | TF-R-①/③ | ○ | ○ | ○ | |
| | | | Polished aluminium | TF-R-①/POL | 49 | 49 | 49 | |
| | Left and right | | Powder-coated aluminium | TF-LR-①/③ | 249 | 249 | 249 | |
| | | | Polished aluminium | TF-LR-①/POL | 345 | 345 | 345 | |
| None | | | | | • | • | • | |
| Media | Quantity | Configuration (⑨) | Position (⑦) | | | | | |
| | One media port | 1 × power socket | YKU8 | A, B or C | J1-YKU8-⑦-⑧ | 465 | 498 | 540 |
| | | 1 × double USB charger | YKU9 | | J1-YKU9-⑦-⑧ | 718 | 751 | 793 |
| | Two media ports | 1 × power socket | YKU8 | A and B | J2-⑨/⑨-⑧ | — | 376 / piece | — |
| | | 1 × double USB charger | YKU9 | | | | 629 / piece | |
| | Three media ports | 1 × power socket | YKU8 | A, B and C | J3-⑨/⑨/⑨-⑧ | — | — | 376 / piece |
| | | 1 × double USB charger | YKU9 | | | | | 629 / piece |
| Glides | Plastic | | | GD | • | • | • | |
| | Plastic with felt | | | GDF | 20 | 20 | 20 | |
| | Plastic nonskid | | | GDN | 17 | 17 | 17 | |
| Wood and wood- based materials | Raw material – EU timber regulation, from certified forests, FSC certificate – authorized companies | | | FSCMIX | • | • | • | |
| Sample order | 8000 BENCH 2U 4L T M/P (E-WK/WK/WK BA-WK SE-KB TF-L-U0901TP/WK GD FSCMIX) | | | | | | | |

① – Please specify wood colour code – [see finishes](#)

③ – Please specify metal colour code – [see finishes](#)

⑦ – Please specify media port position

⑧ – Please specify media port standard: CH23, FR, GB, GE

⑨ – Please specify media port configuration

• Available as standard (included in basic price)

○ Available as an option (included in basic price)

Price list

8000 5, 6-seater bench with table top, PU seat, metal backrest



| | | | | 8000 BENCH 5U 4LT M/P | 8000 BENCH 6U 4LT M/P | |
|-------------------------|--------------------------------|-------------------------------|-------------------------|--------------------------|--------------------------|-----|
| | | | | Basic price (EUR) | | |
| | | | | 3972 | 4541 | |
| Frame | Beam | Seat frame | Legs | | | |
| | Powder-coated | Powder-coated aluminium | Powder-coated aluminium | • | • | |
| | | Powder-coated aluminium | Polished aluminium | 67 | 67 | |
| | | Polished aluminium | Powder-coated aluminium | 233 | 267 | |
| | | Polished aluminium | Polished aluminium | 300 | 334 | |
| | | | E-③③③ | | | |
| Backrest | Powder-coated perforated steel | | BA-③ | • | • | |
| Seat | Black polyurethane (PU) foam | | SE-KB | • | • | |
| | None | | | • | • | |
| Armrests | External armrests | Short | Powder-coated aluminium | ARM-EX-S-③ | 217 | 217 |
| | | | Polished aluminium | ARM-EX-S-POL | 244 | 244 |
| | | | Black polyurethane (PU) | ARM-EX-S-KB | 223 | 223 |
| | | Long | Powder-coated aluminium | ARM-EX-L-③ | 217 | 217 |
| | | | Polished aluminium | ARM-EX-L-POL | 244 | 244 |
| | | | Black polyurethane (PU) | ARM-EX-L-KB | 223 | 223 |
| | Internal armrests | Short | Powder-coated aluminium | ARM-IN-S-③ | 434 | 543 |
| | | | Polished aluminium | ARM-IN-S-POL | 487 | 609 |
| | | | Black polyurethane (PU) | ARM-IN-S-KB | 446 | 557 |
| | | Long | Powder-coated aluminium | ARM-IN-L-③ | 434 | 543 |
| | | | Polished aluminium | ARM-IN-L-POL | 487 | 609 |
| | | | Black polyurethane (PU) | ARM-IN-L-KB | 446 | 557 |
| | External and internal armrests | Short | Powder-coated aluminium | ARM-EI-S-③ | 651 | 760 |
| | | | Polished aluminium | ARM-EI-S-POL | 731 | 852 |
| | | | Black polyurethane (PU) | ARM-EI-S-KB | 668 | 780 |
| | | Long | Powder-coated aluminium | ARM-EI-L-③ | 651 | 760 |
| | | | Polished aluminium | ARM-EI-L-POL | 731 | 852 |
| | | | Black polyurethane (PU) | ARM-EI-L-KB | 668 | 780 |
| | | External long, internal short | Powder-coated aluminium | ARM-EI-LS-③ | 651 | 760 |
| | | | Polished aluminium | ARM-EI-LS-POL | 731 | 852 |
| Black polyurethane (PU) | | | ARM-EI-LS-KB | 668 | 780 | |

③ – Please specify metal colour code – see finishes

- Available as standard (included in basic price)

| | | | | | 8000 BENCH 5U 4LT M/P | 8000 BENCH 6U 4LT M/P | |
|--------------------------------------|---|------------------------|-------------------------|---------------------|--------------------------------|--------------------------|-------------|
| Top | Top position | Top finish (1) | Support (3) | | | | |
| | Left | Resopal traceless | Powder-coated aluminium | TF-L(1)/(3) | • | • | |
| | | | Polished aluminium | TF-L(1)/POL | 49 | 49 | |
| | Right | | Powder-coated aluminium | TF-R(1)/(3) | ○ | ○ | |
| | | | Polished aluminium | TF-R(1)/POL | 49 | 49 | |
| | Left and right | | Powder-coated aluminium | TF-LR(1)/(3) | 249 | 249 | |
| | | | Polished aluminium | TF-LR(1)/POL | 345 | 345 | |
| None | | | | | • | • | |
| Media | Quantity | Configuration (9) | Position (7) | | | | |
| | One media port | 1 × power socket | YKU8 | A, B, C, D or E | J1-YKU8-(7)-(8) | 582 | 622 |
| | | 1 × double USB charger | YKU9 | | J1-YKU9-(7)-(8) | 835 | 875 |
| | Four media ports | 1 × power socket | YKU8 | A, B, C and D | J4-(9)/(9)/(9)/ (9)-(8) | 326 / piece | — |
| | | 1 × double USB charger | YKU9 | | | 579 / piece | |
| | Five media ports | 1 × power socket | YKU8 | A, B, C, D and E | J5-(9)/(9)/(9)/(9)/ (9)-(8) | — | 326 / piece |
| | | 1 × double USB charger | YKU9 | | | 579 / piece | |
| Glides | Plastic | | | GD | • | • | |
| | Plastic with felt | | | GDF | 30 | 30 | |
| | Plastic nonskid | | | GDN | 24 | 24 | |
| Wood and wood-based materials | Raw material – EU timber regulation, from certified forests, FSC certificate – authorized companies | | | FSCMIX | • | • | |
| Sample order | 8000 BENCH 5U 4LT M/P (E-WK/WK/WK BA-WK SE-KB TF-L-U0901TP/WK GD FSCMIX) | | | | | | |

(1) – Please specify wood colour code – [see finishes](#)

(3) – Please specify metal colour code – [see finishes](#)

(7) – Please specify media port position

(8) – Please specify media port standard: CH23, FR, GB, GE

(9) – Please specify media port configuration

• Available as standard (included in basic price)

○ Available as an option (included in basic price)

Price list

8000 2,3,4-seater bench with table top, PU seat and backrest



| 8000 BENCH 2U 4LT P | 8000 BENCH 3U 4LT P | 8000 BENCH 4U 4LT P |
|------------------------|------------------------|------------------------|
| Basic price (EUR) | | |
| 2120 | 2745 | 3368 |

| | Beam | Seat frame | Legs | | | | |
|-------------------------|--------------------------------|-------------------------------|-------------------------|---------------|-----|-----|-----|
| Frame | Powder-coated | Powder-coated aluminium | Powder-coated aluminium | E-③③③ | • | • | |
| | | Powder-coated aluminium | Polished aluminium | | 45 | 45 | 45 |
| | | Polished aluminium | Powder-coated aluminium | | 121 | 156 | 191 |
| | | Polished aluminium | Polished aluminium | | 166 | 200 | 235 |
| Backrest | Black polyurethane (PU) foam | | BA-KB | • | • | • | |
| Seat | Black polyurethane (PU) foam | | SE-KB | • | • | • | |
| | None | | | • | • | • | |
| Armrests | External armrests | Short | Powder-coated aluminium | ARM-EX-S-③ | 217 | 217 | 217 |
| | | | Polished aluminium | ARM-EX-S-POL | 244 | 244 | 244 |
| | | | Black polyurethane (PU) | ARM-EX-S-KB | 223 | 223 | 223 |
| | | Long | Powder-coated aluminium | ARM-EX-L-③ | 217 | 217 | 217 |
| | | | Polished aluminium | ARM-EX-L-POL | 244 | 244 | 244 |
| | | | Black polyurethane (PU) | ARM-EX-L-KB | 223 | 223 | 223 |
| | Internal armrests | Short | Powder-coated aluminium | ARM-IN-S-③ | 109 | 217 | 326 |
| | | | Polished aluminium | ARM-IN-S-POL | 122 | 244 | 366 |
| | | | Black polyurethane (PU) | ARM-IN-S-KB | 112 | 223 | 334 |
| | | Long | Powder-coated aluminium | ARM-IN-L-③ | 109 | 217 | 326 |
| | | | Polished aluminium | ARM-IN-L-POL | 122 | 244 | 366 |
| | | | Black polyurethane (PU) | ARM-IN-L-KB | 112 | 223 | 334 |
| | External and internal armrests | Short | Powder-coated aluminium | ARM-EI-S-③ | 326 | 434 | 543 |
| | | | Polished aluminium | ARM-EI-S-POL | 366 | 487 | 609 |
| | | | Black polyurethane (PU) | ARM-EI-S-KB | 334 | 446 | 557 |
| | | Long | Powder-coated aluminium | ARM-EI-L-③ | 326 | 434 | 543 |
| | | | Polished aluminium | ARM-EI-L-POL | 366 | 487 | 609 |
| | | | Black polyurethane (PU) | ARM-EI-L-KB | 334 | 446 | 557 |
| | | External long, internal short | Powder-coated aluminium | ARM-EI-LS-③ | 326 | 434 | 543 |
| | | | Polished aluminium | ARM-EI-LS-POL | 366 | 487 | 609 |
| Black polyurethane (PU) | | | ARM-EI-LS-KB | 334 | 446 | 557 | |

③ – Please specify metal colour code – [see finishes](#)

- Available as standard (included in basic price)

| | | | | | 8000 BENCH 2U 4L T P | 8000 BENCH 3U 4L T P | 8000 BENCH 4U 4L T P | |
|---|--|---------------------------|-------------------------|-------------|-------------------------|-------------------------|-------------------------|-------------|
| Top | Top position | Top finish (①) | Support (③) | | | | | |
| | Left | | Powder-coated aluminium | TF-L-①/③ | • | • | • | |
| | | | Polished aluminium | TF-L-①/POL | 49 | 49 | 49 | |
| | Right | Resopal traceless | Powder-coated aluminium | TF-R-①/③ | ○ | ○ | ○ | |
| | | | Polished aluminium | TF-R-①/POL | 49 | 49 | 49 | |
| | Left and right | | Powder-coated aluminium | TF-LR-①/③ | 249 | 249 | 249 | |
| | | | Polished aluminium | TF-LR-①/POL | 345 | 345 | 345 | |
| None | | | | | • | • | • | |
| Media | Quantity | Configuration (⑨) | Position (⑦) | | | | | |
| | One media port | 1 × power socket | YKU8 | A, B or C | J1-YKU8-⑦-⑧ | 465 | 498 | 540 |
| | | 1 × double USB charger | YKU9 | | J1-YKU9-⑦-⑧ | 718 | 751 | 793 |
| | Two media ports | 1 × power socket | YKU8 | A and B | J2-⑨/⑨-⑧ | — | 376 / piece | — |
| | | 1 × double USB charger | YKU9 | | | | 629 / piece | |
| | Three media ports | 1 × power socket | YKU8 | A, B and C | J3-⑨/⑨/⑨-⑧ | — | — | 376 / piece |
| | | 1 × double USB charger | YKU9 | | | | 629 / piece | |
| Glides | Plastic | | | GD | • | • | • | |
| | Plastic with felt | | | GDF | 20 | 20 | 20 | |
| | Plastic nonskid | | | GDN | 17 | 17 | 17 | |
| Wood and wood- based materials | Raw material – EU timber regulation, from certified forests, FSC certificate – authorized companies | | | FSCMIX | • | • | • | |
| Sample order | 8000 BENCH 2U 4L T P (E-WK/WK/WK BA-KB SE-KB TF-L-U0901TP/WK GD FSCMIX) | | | | | | | |

① – Please specify wood colour code – [see finishes](#)

③ – Please specify metal colour code – [see finishes](#)

⑦ – Please specify media port position

⑧ – Please specify media port standard: CH23, FR, GB, GE

⑨ – Please specify media port configuration

• Available as standard (included in basic price)

○ Available as an option (included in basic price)

Price list

8000 5, 6-seater bench with table top, PU seat and backrest



| | | | | 8000 BENCH 5U 4L T P | 8000 BENCH 6U 4L T P | |
|-------------------------|--------------------------------|-------------------------|-------------------------|-------------------------|-------------------------|-----|
| | | | | Basic price (EUR) | | |
| | | | | 4200 | 4822 | |
| Frame | Beam | Seat frame | Legs | | | |
| | Powder-coated | Powder-coated aluminium | Powder-coated aluminium | • | • | |
| | | Powder-coated aluminium | Polished aluminium | 67 | 67 | |
| | | Polished aluminium | Powder-coated aluminium | 233 | 267 | |
| | | Polished aluminium | Polished aluminium | 300 | 334 | |
| | | | E-③③③ | | | |
| Backrest | Black polyurethane (PU) foam | | BA-KB | • | • | |
| Seat | Black polyurethane (PU) foam | | SE-KB | • | • | |
| | None | | | • | • | |
| Armrests | External armrests | Short | Powder-coated aluminium | ARM-EX-S-③ | 217 | 217 |
| | | | Polished aluminium | ARM-EX-S-POL | 244 | 244 |
| | | | Black polyurethane (PU) | ARM-EX-S-KB | 223 | 223 |
| | | Long | Powder-coated aluminium | ARM-EX-L-③ | 217 | 217 |
| | | | Polished aluminium | ARM-EX-L-POL | 244 | 244 |
| | | | Black polyurethane (PU) | ARM-EX-L-KB | 223 | 223 |
| | Internal armrests | Short | Powder-coated aluminium | ARM-IN-S-③ | 434 | 543 |
| | | | Polished aluminium | ARM-IN-S-POL | 487 | 609 |
| | | | Black polyurethane (PU) | ARM-IN-S-KB | 446 | 557 |
| | | Long | Powder-coated aluminium | ARM-IN-L-③ | 434 | 543 |
| | | | Polished aluminium | ARM-IN-L-POL | 487 | 609 |
| | | | Black polyurethane (PU) | ARM-IN-L-KB | 446 | 557 |
| | External and internal armrests | Short | Powder-coated aluminium | ARM-EI-S-③ | 651 | 760 |
| | | | Polished aluminium | ARM-EI-S-POL | 731 | 852 |
| | | | Black polyurethane (PU) | ARM-EI-S-KB | 668 | 780 |
| | | Long | Powder-coated aluminium | ARM-EI-L-③ | 651 | 760 |
| | | | Polished aluminium | ARM-EI-L-POL | 731 | 852 |
| | | | Black polyurethane (PU) | ARM-EI-L-KB | 668 | 780 |
| | External long, internal short | Powder-coated aluminium | ARM-EI-LS-③ | 651 | 760 | |
| | | Polished aluminium | ARM-EI-LS-POL | 731 | 852 | |
| Black polyurethane (PU) | | ARM-EI-LS-KB | 668 | 780 | | |

③ – Please specify metal colour code – [see finishes](#)

- Available as standard (included in basic price)

| | | | | | 8000 BENCH 5U 4LT P | 8000 BENCH 6U 4LT P | |
|--------------------------------------|---|------------------------|-------------------------|---------------------|------------------------|------------------------|-------------|
| Top | Top position | Top finish (①) | Support (③) | | | | |
| | Left | Resopal traceless | Powder-coated aluminium | TF-L-①/③ | • | • | |
| | | | Polished aluminium | TF-L-①/POL | 49 | 49 | |
| | Right | | Powder-coated aluminium | TF-R-①/③ | ○ | ○ | |
| | | | Polished aluminium | TF-R-①/POL | 49 | 49 | |
| | Left and right | | Powder-coated aluminium | TF-LR-①/③ | 249 | 249 | |
| | | | Polished aluminium | TF-LR-①/POL | 345 | 345 | |
| None | | | | | • | • | |
| Media | Quantity | Configuration (⑨) | Position (⑦) | | | | |
| | One media port | 1 × power socket | YKU8 | A, B, C, D or E | J1-YKU8-⑦-⑧ | 582 | 622 |
| | | 1 × double USB charger | YKU9 | | J1-YKU9-⑦-⑧ | 835 | 875 |
| | Four media ports | 1 × power socket | YKU8 | A, B, C and D | J4-⑨/⑨/⑨/ ⑨-⑧ | 326 / piece | — |
| | | 1 × double USB charger | YKU9 | | | 579 / piece | |
| | Five media ports | 1 × power socket | YKU8 | A, B, C, D and E | J5-⑨/⑨/⑨/⑨/ ⑨-⑧ | — | 326 / piece |
| | | 1 × double USB charger | YKU9 | | | 579 / piece | |
| Glides | Plastic | | | GD | • | • | |
| | Plastic with felt | | | GDF | 30 | 30 | |
| | Plastic nonskid | | | GDN | 24 | 24 | |
| Wood and wood-based materials | Raw material – EU timber regulation, from certified forests, FSC certificate – authorized companies | | | FSCMIX | • | • | |
| Sample order | 8000 BENCH 5U 4LT P (E-WK/WK/WK BA-KB SE-KB TF-L-U0901TP/WK GD FSCMIX) | | | | | | |

- ① – Please specify wood colour code – [see finishes](#)
 ③ – Please specify metal colour code – [see finishes](#)
 ⑦ – Please specify media port position
 ⑧ – Please specify media port standard: CH23, FR, GB, GE
 ⑨ – Please specify media port configuration
- Available as standard (included in basic price)
 - Available as an option (included in basic price)

Price list

8000 2,3,4-seater bench with table top, upholstered seat and backrest



| 8000 BENCH 2U 4LT UPH | 8000 BENCH 3U 4LT UPH | 8000 BENCH 4U 4LT UPH |
|--------------------------|--------------------------|--------------------------|
|--------------------------|--------------------------|--------------------------|

Basic price (EUR)
according to upholstery price group

| | | | | 2560 | 3396 | 4234 | |
|--------------------|-----------------------------------|-------------------------|-------------------------|---|------|------|-----|
| Price group 4 | | | | 2560 | 3396 | 4234 | |
| Price group 6 | | | | 3024 | 4093 | 5165 | |
| Frame | Beam | Seat frame | Legs | | | | |
| | Powder-coated | Powder-coated aluminium | Powder-coated aluminium | E- ^③ / ^③ / ^③ | • | • | • |
| | | Powder-coated aluminium | Polished aluminium | | 45 | 45 | 45 |
| | | Polished aluminium | Powder-coated aluminium | | 121 | 156 | 191 |
| Polished aluminium | | Polished aluminium | 166 | | 200 | 235 | |
| Backrest | Upholstered | | BA- ^⑤ | • | • | • | |
| Seat | Upholstered | | SE- ^⑤ | • | • | • | |
| Raised seat | No raised seat | | | | • | • | • |
| | Raised seat in position A | | | SS-R-A | 170 | 170 | 170 |
| | Raised seat in position B | | | SS-R-B | 170 | — | — |
| | Raised seat in position C | | | SS-R-C | | 170 | |
| | Raised seat in position D | | | SS-R-D | | | 170 |
| | Raised seats in positions A and B | | | SS-R-AB | — | — | 340 |
| | Raised seats in positions C and D | | | SS-R-CD | | | 340 |
| None | | | | • | • | • | |
| Armrests | External armrests | Short | Powder-coated aluminium | ARM-EX-S- ^③ | 217 | 217 | 217 |
| | | | Polished aluminium | ARM-EX-S-POL | 244 | 244 | 244 |
| | | | Black polyurethane (PU) | ARM-EX-S-KB | 223 | 223 | 223 |
| | | Long | Powder-coated aluminium | ARM-EX-L- ^③ | 217 | 217 | 217 |
| | | | Polished aluminium | ARM-EX-L-POL | 244 | 244 | 244 |
| | | | Black polyurethane (PU) | ARM-EX-L-KB | 223 | 223 | 223 |

^③ – Please specify metal colour code – see finishes

^⑤ – Please specify upholstery colour code from selected price group – see finishes

• Available as standard (included in basic price)

| | | | | 8000 BENCH 2U 4L T UPH | 8000 BENCH 3U 4L T UPH | 8000 BENCH 4U 4L T UPH | | |
|--------------------------------------|---|-------------------------|-------------------------|---------------------------|---------------------------|---------------------------|-------------|-------------|
| Armrests | Internal armrests | Short | Powder-coated aluminium | ARM-IN-S-③ | 109 | 217 | 326 | |
| | | | Polished aluminium | ARM-IN-S-POL | 122 | 244 | 366 | |
| | | | Black polyurethane (PU) | ARM-IN-S-KB | 112 | 223 | 334 | |
| | | Long | Powder-coated aluminium | ARM-IN-L-③ | 109 | 217 | 326 | |
| | | | Polished aluminium | ARM-IN-L-POL | 122 | 244 | 366 | |
| | | | Black polyurethane (PU) | ARM-IN-L-KB | 112 | 223 | 334 | |
| | External and internal armrests | Short | Powder-coated aluminium | ARM-EI-S-③ | 326 | 434 | 543 | |
| | | | Polished aluminium | ARM-EI-S-POL | 366 | 487 | 609 | |
| | | | Black polyurethane (PU) | ARM-EI-S-KB | 334 | 446 | 557 | |
| | | Long | Powder-coated aluminium | ARM-EI-L-③ | 326 | 434 | 543 | |
| | | | Polished aluminium | ARM-EI-L-POL | 366 | 487 | 609 | |
| | | | Black polyurethane (PU) | ARM-EI-L-KB | 334 | 446 | 557 | |
| External long, internal short | Powder-coated aluminium | ARM-EI-LS-③ | 326 | 434 | 543 | | | |
| | Polished aluminium | ARM-EI-LS-POL | 366 | 487 | 609 | | | |
| | Black polyurethane (PU) | ARM-EI-LS-KB | 334 | 446 | 557 | | | |
| Top | Top position | Top finish ① | Support ③ | | | | | |
| | Left | Powder-coated aluminium | | TF-L-①/③ | • | • | • | |
| | | Polished aluminium | | TF-L-①/POL | 49 | 49 | 49 | |
| | Right | Resopal traceless | Powder-coated aluminium | | TF-R-①/③ | ◦ | ◦ | ◦ |
| | | | Polished aluminium | | TF-R-①/POL | 49 | 49 | 49 |
| | Left and right | Powder-coated aluminium | | TF-LR-①/③ | 249 | 249 | 249 | |
| Polished aluminium | | TF-LR-①/POL | 345 | 345 | 345 | | | |
| None | | | | • | • | • | | |
| Media | Quantity | Configuration ⑨ | Position ⑦ | | | | | |
| | One media port | 1 × power socket | YKU8 | A, B or C | J1-YKU8-⑦-⑧ | 465 | 498 | 540 |
| | | 1 × double USB charger | YKU9 | | J1-YKU9-⑦-⑧ | 718 | 751 | 793 |
| | Two media ports | 1 × power socket | YKU8 | A and B | J2-⑨/⑨-⑧ | – | 376 / piece | – |
| | | 1 × double USB charger | YKU9 | | | 629 / piece | – | |
| | Three media ports | 1 × power socket | YKU8 | A, B and C | J3-⑨/⑨/⑨-⑧ | – | – | 376 / piece |
| 1 × double USB charger | | YKU9 | 629 / piece | | | – | | |
| Glides | Plastic | | | GD | • | • | • | |
| | Plastic with felt | | | GDF | 20 | 20 | 20 | |
| | Plastic nonskid | | | GDN | 17 | 17 | 17 | |
| Foam | Standard foam | | | FSTD | • | • | • | |
| | Flame retardant foam | | | FFR2 | 58 | 86 | 115 | |
| | Flame retardant foam with fireproof fabric | | | FFRF | 365 | 546 | 727 | |
| Wood and wood-based materials | Raw material – EU timber regulation, from certified forests, FSC certificate – authorized companies | | | FSCMIX | • | • | • | |
| Sample order | 8000 BENCH 2U 4L T UPH (E-WK/WK/WK BA-NF705 SE-NF705 TF-L-U0901TP/WK GD FSTD FSCMIX) | | | | | | | |

① – Please specify wood colour code – [see finishes](#)

③ – Please specify metal colour code – [see finishes](#)

⑦ – Please specify media port position

⑧ – Please specify media port standard: CH23, FR, GB, GE

⑨ – Please specify media port configuration

• Available as standard (included in basic price)

◦ Available as an option (included in basic price)

Price list

8000 5, 6-seater bench with table top, upholstered seat and backrest



8000 BENCH 5U
4L T UPH

8000 BENCH 6U
4L T UPH

Basic price (EUR)
according to upholstery price group

| | | | | 8000 BENCH 5U 4L T UPH | 8000 BENCH 6U 4L T UPH | |
|--------------------|-----------------------------------|-------------------------|-------------------------|---------------------------|---------------------------|-----|
| Price group 4 | | | | 5277 | 6116 | |
| Price group 6 | | | | 6439 | 7511 | |
| Frame | Beam | Seat frame | Legs | | | |
| | Powder-coated | Powder-coated aluminium | Powder-coated aluminium | E-③③③ | • | • |
| | | Powder-coated aluminium | Polished aluminium | | 67 | 67 |
| | | Polished aluminium | Powder-coated aluminium | | 233 | 267 |
| Polished aluminium | | Polished aluminium | 300 | | 334 | |
| Backrest | Upholstered | | BA-⑤ | • | • | |
| Seat | Upholstered | | SE-⑤ | • | • | |
| Raised seat | No raised seat | | | | • | • |
| | Raised seat in position A | | | SS-R-A | 170 | 170 |
| | Raised seat in position E | | | SS-R-B | 170 | |
| | Raised seats in positions A and B | | | SS-R-AB | 340 | – |
| | Raised seats in positions D and E | | | SS-R-DE | 340 | |
| | Raised seat in position F | | | SS-R-F | – | 170 |
| | Raised seats in positions E and F | | | SS-R-EF | | 340 |
| Armrests | External armrests | Short | Powder-coated aluminium | ARM-EX-S-③ | 217 | 217 |
| | | | Polished aluminium | ARM-EX-S-POL | 244 | 244 |
| | | | Black polyurethane (PU) | ARM-EX-S-KB | 223 | 223 |
| | | Long | Powder-coated aluminium | ARM-EX-L-③ | 217 | 217 |
| | | | Polished aluminium | ARM-EX-L-POL | 244 | 244 |
| | | | Black polyurethane (PU) | ARM-EX-L-KB | 223 | 223 |

③ – Please specify metal colour code – [see finishes](#)

⑤ – Please specify upholstery colour code from selected price group – [see finishes](#)

• Available as standard (included in basic price)

| | | | | 8000 BENCH 5U 4L T UPH | 8000 BENCH 6U 4L T UPH | | |
|--------------------------------------|---|-------------------------|-------------------------|---------------------------|---------------------------|-------------|-------------|
| Armrests | Internal armrests | Short | Powder-coated aluminium | ARM-IN-S-③ | 434 | 543 | |
| | | | Polished aluminium | ARM-IN-S-POL | 487 | 609 | |
| | | | Black polyurethane (PU) | ARM-IN-S-KB | 446 | 557 | |
| | | Long | Powder-coated aluminium | ARM-IN-L-③ | 434 | 543 | |
| | | | Polished aluminium | ARM-IN-L-POL | 487 | 609 | |
| | | | Black polyurethane (PU) | ARM-IN-L-KB | 446 | 557 | |
| | External and internal armrests | Short | Powder-coated aluminium | ARM-EI-S-③ | 651 | 760 | |
| | | | Polished aluminium | ARM-EI-S-POL | 731 | 852 | |
| | | | Black polyurethane (PU) | ARM-EI-S-KB | 668 | 780 | |
| | | Long | Powder-coated aluminium | ARM-EI-L-③ | 651 | 760 | |
| | | | Polished aluminium | ARM-EI-L-POL | 731 | 852 | |
| | | | Black polyurethane (PU) | ARM-EI-L-KB | 668 | 780 | |
| External long, internal short | Powder-coated aluminium | ARM-EI-LS-③ | 651 | 760 | | | |
| | Polished aluminium | ARM-EI-LS-POL | 731 | 852 | | | |
| | Black polyurethane (PU) | ARM-EI-LS-KB | 668 | 780 | | | |
| Top | Top position | Top finish ① | Support ③ | | | | |
| | Left | Powder-coated aluminium | | TF-L-①/③ | • | • | |
| | | Polished aluminium | | TF-L-①/POL | 49 | 49 | |
| | Right | Resopal traceless | Powder-coated aluminium | | TF-R-①/③ | ◦ | ◦ |
| | | | Polished aluminium | | TF-R-①/POL | 49 | 49 |
| | Left and right | Powder-coated aluminium | | TF-LR-①/③ | 249 | 249 | |
| | | Polished aluminium | | TF-LR-①/POL | 345 | 345 | |
| None | | | | • | • | | |
| Media | Quantity | Configuration ⑨ | Position ⑦ | | | | |
| | One media port | 1 x power socket | YKU8 | A, B, C, D or E | J1-YKU8-⑦-⑧ | 582 | 622 |
| | | 1 x double USB charger | YKU9 | | J1-YKU9-⑦-⑧ | 835 | 875 |
| | Four media ports | 1 x power socket | YKU8 | A, B, C and D | J4-⑨/⑨/⑨/⑨/ ⑨-⑧ | 326 / piece | — |
| | | 1 x double USB charger | YKU9 | | | 579 / piece | |
| | Five media ports | 1 x power socket | YKU8 | A, B, C, D and E | J5-⑨/⑨/⑨/⑨/⑨/ ⑨-⑧ | — | 326 / piece |
| 1 x double USB charger | | YKU9 | 579 / piece | | | | |
| Glides | Plastic | | GD | • | • | | |
| | Plastic with felt | | GDF | 30 | 30 | | |
| | Plastic nonskid | | GDN | 24 | 24 | | |
| Foam | Standard foam | | FSTD | • | • | | |
| | Flame retardant foam | | FFR2 | 144 | 172 | | |
| | Flame retardant foam with fireproof fabric | | FFRF | 910 | 1091 | | |
| Wood and wood-based materials | Raw material – EU timber regulation, from certified forests, FSC certificate – authorized companies | | FSCMIX | • | • | | |
| Sample order | 8000 BENCH 5U 4L T UPH (E-WK/WK/WK BA-NF705 SE-NF705 TF-L-U0901TP/WK GD FSTD FSCMIX) | | | | | | |

- ① – Please specify wood colour code – [see finishes](#)
 ③ – Please specify metal colour code – [see finishes](#)
 ⑦ – Please specify media port position
 ⑧ – Please specify media port standard: CH23, FR, GB, GE
 ⑨ – Please specify media port configuration

- Available as standard (included in basic price)
 ◦ Available as an option (included in basic price)

Price list

8000 floor fixing

8000 BENCH ACCESSORY FF

Basic price (EUR)

140

Finishes

Metal



**Polished
Aluminium**
POL



RAL 9006
White
Aluminium
WK

Laminate



U0901TP
Traceless
Black

Polyurethane



KB
Black

General notes

All specified dimensions are approximate. Subject to minor modifications or differences for reasons of design improvements or for technical reasons.

- W = width
- D = depth
- H = height
- DI = diameter
- SH = seat height
- SH DIN = seat height measured acc. to DIN EN 1335-1

In compliance with the highest quality standards "Quality is irreplaceable." Guided by this principle, each product line is subjected to stringent quality testing.

Only the products marked in this document are FSC® (FSC®-C120977) certified. Look for our FSC®-certified products. Sale of products that meet the FSC® requirements is possible only by Nowy Styl Sp. z o.o., Nowy Styl Nederland B.V. and Kusch + Co GmbH.



The FSC® certificate applies to responsible forest management and the entire flow of raw materials from the forest to the customer. Each stage of the chain is monitored in terms of social, ecological and economic performance. The product with the FSC® label gives customers a guarantee that the wood used for the production of the product comes from sources managed in a sustainable manner.

Warranty

Manufacturer declares that the products shall be free from defects in material or workmanship. The warranty is given to the original purchaser only, for normal commercial usage. Detailed terms of warranty and warranty periods are available at <https://www.kusch.com/en/warranty>

volpe price list 2026

Volpe

Design by Norbert Geelen

Armchair/leg rest on sled metal frame



**VOLPE LEG REST
SL UPH**



**VOLPE ARMCHAIR
SL UPH**



**VOLPE ARMCHAIR
SL HB UPH**

Armchair/leg rest on 4 wooden legs



**VOLPE LEG REST
LWM UPH**



**VOLPE ARMCHAIR
LWM UPH**



**VOLPE ARMCHAIR
LWM HB UPH**

Price list

Volpe leg rest on sled metal frame

Upholstered seat.
Sled frame made of powder-coated or chromium plated steel,
plastic glides.



VOLPE LEG REST SL UPH

W 570 mm
D 550 mm
SH 420 mm
SH DIN 405 mm
WT 8 kg

Basic price (EUR) according to upholstery price group

| | | | | |
|--------------------------------------|---|-----------------------|--------|-----|
| | Price group 2 | | | 655 |
| | Price group 3 | | | 671 |
| | Price group 4 | | | 696 |
| | Price group 5 | | | 712 |
| | Price group 6 | | | 917 |
| Frame | Steel | powder-coated | E-③ | • |
| | | chromium plated steel | | 34 |
| Seat | Upholstered | | SE-⑤ | • |
| Glides | Plastic | | GD | • |
| | Plastic with felt | | GDF | 8 |
| Foam | Standard foam | | FSTD | • |
| | Flame retardant foam | | FFR2 | 10 |
| | Flame retardant foam with fireproof fabric | | FFRF | 107 |
| Wood and wood-based materials | Raw material from certified forests, FSC certificate – authorized companies | | FSCMIX | • |

Sample order VOLPE STOOL SL UPH (E-BK SE-CPC11 GD FSTD FSCMIX)

③ – Please specify metal colour code – [see finishes](#)

⑤ – Please specify upholstery colour code from selected price group – [see finishes](#)

• Available as standard (included in basic price)

PRICE GROUP 2: Boogie, Cura, Cura Loop, Home, Valencia, Xtreme
PRICE GROUP 3: Chili, Moulin-Fr, Silvertex, Step/Step Melange
PRICE GROUP 4: Blazer, Focus Royal, Main Line Flax, Oceanic, skai Parotega, Synergy
PRICE GROUP 5: Remix 3
PRICE GROUP 6: Nappa leather

Price list

Volpe armchair on sled metal frame

Upholstered seat.
Sled frame made of powder-coated or chromium plated steel,
plastic glides.



VOLPE ARMCHAIR SL UPH

W 720 mm
D 690 mm
H 810 mm
SH 420 mm
SH DIN 420 mm
WT 12,5 kg

VOLPE ARMCHAIR SL HB UPH

W 720 mm
D 760 mm
H 1110 mm
SH 420 mm
SH DIN 420 mm
WT 18 kg

Basic price (EUR) according to upholstery price group

| | | | | 1000 | 1490 |
|--------------------------------------|---|-----------------------|------------------|------|------|
| | Price group 2 | | | | |
| | Price group 3 | | | 1039 | 1534 |
| | Price group 4 | | | 1084 | 1590 |
| | Price group 5 | | | 1117 | 1633 |
| | Price group 6 | | | 1560 | 2198 |
| Frame | Steel | powder-coated | E- ^③ | • | • |
| | | chromium plated steel | | 34 | 34 |
| Shell | Upholstered | | BS- ^⑤ | • | • |
| Glides | Plastic | | GD | • | • |
| | Plastic with felt | | GDF | 8 | 8 |
| Foam | Standard foam | | FSTD | • | • |
| | Flame retardant foam | | FFR2 | 35 | 43 |
| | Flame retardant foam with fireproof fabric | | FFRF | 302 | 360 |
| Wood and wood-based materials | Raw material from certified forests, FSC certificate – authorized companies | | FSCMIX | • | • |
| Sample order | VOLPE ARMCHAIR SL UPH (E-BK BS-CPC16 GD FSTD FSCMIX) | | | | |

^③ – Please specify metal colour code – [see finishes](#)

^⑤ – Please specify upholstery colour code from selected price group – [see finishes](#)

• Available as standard (included in basic price)

PRICE GROUP 2: Boogie, Cura, Cura Loop, Home, Valencia, Xtreme
PRICE GROUP 3: Chili, Moulin-Fr, Silvertex, Step/Step Melange
PRICE GROUP 4: Blazer, Focus Royal, Main Line Flax, Oceanic, skai Parotega, Synergy
PRICE GROUP 5: Remix 3
PRICE GROUP 6: Nappa leather

Volpe leg rest on 4 wooden legs

Upholstered seat.
Beech legs with powder-coated steel leg mountings,
plastic glides.



VOLPE LEG REST LWM UPH

W 570 mm
D 550 mm
SH 420 mm
SH DIN 415 mm
WT 7 kg

Basic price (EUR) according to upholstery price group

| | | | | |
|--------------------------------------|---|---------------|-----------|------|
| | Price group 2 | | | 784 |
| | Price group 3 | | | 800 |
| | Price group 4 | | | 824 |
| | Price group 5 | | | 842 |
| | Price group 6 | | | 1048 |
| | Mounting | Legs | | |
| Frame | Powder-coated steel | Natural beech | E-(3)/(1) | • |
| | | Stained beech | | 20 |
| Seat | Upholstered | | SE-(5) | • |
| Glides | Plastic | | GD | • |
| | Plastic with felt | | GDF | 8 |
| | Protect glides | | GDT | 9 |
| Foam | Standard foam | | FSTD | • |
| | Flame retardant foam | | FFR2 | 10 |
| | Flame retardant foam with fireproof fabric | | FFRF | 107 |
| Wood and wood-based materials | Raw material from certified forests, FSC certificate – authorized companies | | FSCMIX | • |
| Wooden elements lacquering | Water lacquer UV | | UV | • |
| | Water lacquer | | | -20 |
| Sample order | VOLPE STOOL LWM UPH (E-WS/SKNB SE-CPC10 GD FSTD FSCMIX UV) | | | |

- ① – Please specify wood colour code – [see finishes](#)
 ③ – Please specify metal colour code – [see finishes](#)
 ⑤ – Please specify upholstery colour code from selected price group – [see finishes](#)

- Available as standard (included in basic price)

PRICE GROUP 2: Boogie, Cura, Cura Loop, Home, Valencia, Xtreme
 PRICE GROUP 3: Chili, Moulin-Fr, Silvertex, Step/Step Melange
 PRICE GROUP 4: Blazer, Focus Royal, Main Line Flax, Oceanic, skai Parotega, Synergy
 PRICE GROUP 5: Remix 3
 PRICE GROUP 6: Nappa leather

Price list

Volpe armchair on 4 wooden legs

Upholstered shell.
Beech legs with powder-coated steel leg mountings,
plastic glides.



**VOLPE ARMCHAIR
LWM UPH**

W 720 mm
D 690 mm
H 810 mm
SH 420 mm
SH DIN 415 mm
WT 11,5 kg

**VOLPE ARMCHAIR
LWM HB UPH**

W 720 mm
D 760 mm
H 1110 mm
SH 420 mm
SH DIN 415 mm
WT 17 kg

Basic price (EUR) according to upholstery price group

| | Price group 2 | | | | 1131 | 1622 |
|--------------------------------------|---|---------------|-----------|--|------|------|
| | Price group 3 | | | | 1167 | 1661 |
| | Price group 4 | | | | 1214 | 1719 |
| | Price group 5 | | | | 1245 | 1760 |
| | Price group 6 | | | | 1690 | 2328 |
| Frame | Mounting | Legs | | | | |
| | Powder-coated steel | Natural beech | E-(3)/(1) | | • | • |
| | | Stained beech | | | 20 | 20 |
| Shell | Upholstered | | BS-(5) | | • | • |
| Glides | Plastic | | GD | | • | • |
| | Plastic with felt | | GDF | | 8 | 8 |
| | Protect glides | | GDT | | 9 | 9 |
| Foam | Standard foam | | FSTD | | • | • |
| | Flame retardant foam | | FFR2 | | 35 | 43 |
| | Flame retardant foam with fireproof fabric | | FFRF | | 302 | 360 |
| Wood and wood-based materials | Raw material from certified forests, FSC certificate – authorized companies | | FSCMIX | | • | • |
| Wooden elements lacquering | Water lacquer UV | | UV | | • | • |
| | Water lacquer | | | | - 20 | - 20 |

Sample order VOLPE ARMCHAIR LWM UPH (E-WS/SKNB BS-CPC05 GD FSTD FSCMIX UV)

① – Please specify wood colour code – [see finishes](#)

③ – Please specify metal colour code – [see finishes](#)

⑤ – Please specify upholstery colour code from selected price group – [see finishes](#)

• Available as standard (included in basic price)

PRICE GROUP 2: Boogie, Cura, Cura Loop, Home, Valencia, Xtreme
PRICE GROUP 3: Chili, Moulin-Fr, Silvertex, Step/Step Melange
PRICE GROUP 4: Blazer, Focus Royal, Main Line Flax, Oceanic, skai Parotega, Synergy
PRICE GROUP 5: Remix 3
PRICE GROUP 6: Nappa leather

Finishes

Wood

Natural



SKNB
Natural
Beech

Stained



2.07Y
Black



2.06S
Slate



S39
Light Grey



2.09S
White



2.0CB
Acacia



SK40
Oak



2.0CC
Walnut

Metal

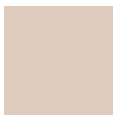

**NCS S
2005-Y60R**
Cashmere
NK



RAL 1024
Ochre Yellow
OY



**RAL 030
50 40**
Vermilion
Red
VR



RAL 6003
Olive Green
OG



RAL 5000
Violet Blue
VB



Chrome
CR



RAL 9003
Signal White
WS



RAL 9006
White
Aluminium
WK



RAL 9005
Jet Black
BK

General notes

All specified dimensions are approximate. Subject to minor modifications or differences for reasons of design improvements or for technical reasons.

- W = width
- D = depth
- H = height
- DI = diameter
- SH = seat height
- SH DIN = seat height measured acc. to DIN EN 1335-1

In compliance with the highest quality standards "Quality is irreplaceable." Guided by this principle, each product line is subjected to stringent quality testing.

Only the products marked in this document are FSC® (FSC®-C120977). Look for our FSC®-certified products. Sale of products that meet the FSC® requirements is possible only by Nowy Styl Sp. z o.o., Nowy Styl Nederland B.V. and Kusch + Co GmbH.



The mark of responsible forestry

The FSC® certificate applies to responsible forest management and the entire flow of raw materials from the forest to the customer. Each stage of the chain is monitored in terms of social, ecological and economic performance. The product with the FSC® label gives customers a guarantee that the wood used for the production of the product comes from sources managed in a sustainable manner.

Warranty

Manufacturer declares that the products shall be free from defects in material or workmanship. The warranty is given to the original purchaser only, for normal commercial usage. Detailed terms of warranty and warranty periods are available at <https://www.kusch.com/en/warranty>

volpino price list 2026

Volpino

Design by Norbert Geelen

Armchair on 4 metal legs



VOLPINO ARMCHAIR LWM P

Armchair on X-sled metal frame



VOLPINO ARMCHAIR 4L P

Armchair on 4 wooden legs



VOLPINO ARMCHAIR SL P

Swivel armchair



**VOLPINO ARMCHAIR
SWIVEL P KO**



**VOLPINO ARMCHAIR
MOB P KO**

Bench



**VOLPINO BENCH
2U 4L P**



**VOLPINO BENCH
3U 4L P**



**VOLPINO BENCH
4U 4L P**



**VOLPINO BENCH
5U 4L P**



**VOLPINO BENCH
6U 4L P**

Price list

Volpino armchair on 4 wooden legs

Shell made of plastic.
Legs made of solid beech wood, leg mountings made of powder-coated steel, plastic glides.



VOLPINO ARMCHAIR LWM P

W 660 mm
D 560 mm
H 820 mm
SH 450 mm
SH DIN 430 mm
WT 7 kg

Basic price (EUR)

408

| | Mounting | Legs | | | | | |
|--------------------------------------|---|------------------|---------|-----------|--|--|---------|
| Frame | Powder-coated steel | Solid beech wood | natural | E-(3)/(1) | | | • |
| | | | stained | | | | 19 |
| Shell | Plastic | | | CC-(4) | | | • |
| | None | | | | | | • • - |
| Backrest pad | Upholstered | Price group | 2 | BA-PD-(5) | | | 121 |
| | | | 3 | | | | 130 |
| | | | 4 | | | | 142 |
| | | | 6 | | | | 248 |
| | | | None | | | | |
| Seat pad | Upholstered | Price group | 2 | SE-PD-(5) | | | 139 139 |
| | | | 3 | | | | 150 150 |
| | | | 4 | | | | 166 166 |
| | | | 6 | | | | 261 261 |
| | | | None | | | | |
| Glides | Plastic | | | GD | | | • |
| | Plastic with felt | | | GDF | | | 8 |
| | Protect glides | | | GDT | | | 9 |
| Foam | Flame retardant foam | | | FFR2 | | | • • |
| | Low flammability foam | | | FFR3 | | | 20 41 |
| Wood and wood-based materials | Raw material from certified forests, FSC certificate – authorized companies | | | FSC | | | • |
| Wooden elements lacquering | Water lacquer UV | | | UV | | | • |
| | Water lacquer | | | | | | - 20 |
| Sample order | VOLPINO ARMCHAIR LWM P (E-WS/SKNB CC-KK GD FSC UV) | | | | | | |

- ① – Please specify wood colour code – [see finishes](#)
 ③ – Please specify metal colour code – [see finishes](#)
 ④ – Please specify plastic colour code – [see finishes](#)
 ⑤ – Please specify upholstery colour code from selected price group – [see finishes](#)

• Available as standard (included in basic price)

PRICE GROUP 2: Cura, Cura Loop, Valencia, Xtreme
 PRICE GROUP 3: Silvertex, Step/Step Melange
 PRICE GROUP 4: Blazer, Main Line Flax, Oceanic, skai Parotega, Synergy
 PRICE GROUP 6: Nappa leather

Price list

Volpino armchair on 4 metal legs/sled metal frame

Shell made of plastic.

Frame on 4 legs made of powder-coated or chromium plated steel, plastic glides.



VOLPINO ARMCHAIR 4L P

W 660 mm
D 570 mm
H 820 mm
SH 450 mm
SH DIN 430 mm
WT 6,5 kg

VOLPINO ARMCHAIR SL P

W 660 mm
D 550 mm
H 820 mm
SH 450 mm
SH DIN 435 mm
WT 8,5 kg

Basic price (EUR)

275

381

| | | | | 275 | | 381 | | | | |
|--------------------------------------|---|-----------------|------------------|---------------------|----|-----|-----|----|-----|-----|
| Frame | Steel | powder-coated | E- ^③ | • | | | • | | | |
| | | chromium plated | | 18 | | | 45 | | | |
| Shell | Plastic | | CC- ^④ | • | | | • | | | |
| Backrest pad | Upholstered | None | Price group | • | • | – | • | • | – | |
| | | 2 | | BA-PD- ^⑤ | – | – | 121 | – | – | 121 |
| | | 3 | | | – | – | 130 | – | – | 130 |
| | | 4 | | | – | – | 142 | – | – | 142 |
| | | 6 | | | – | – | 248 | – | – | 248 |
| Seat pad | Upholstered | None | Price group | • | – | – | • | – | – | |
| | | 2 | | SE-PD- ^⑤ | – | 139 | 139 | – | 139 | 139 |
| | | 3 | | | – | 150 | 150 | – | 150 | 150 |
| | | 4 | | | – | 166 | 166 | – | 166 | 166 |
| | | 6 | | | – | 261 | 261 | – | 261 | 261 |
| Glides | Plastic | | GD | • | | | • | | | |
| | Plastic with felt | | GDF | 8 | | | 8 | | | |
| | Protect glides | | GDT | 9 | | | | | | |
| Foam | Flame retardant foam | | FFR2 | – | • | • | – | • | • | |
| | Low flammability foam | | FFR3 | – | 20 | 41 | – | 20 | 41 | |
| Wood and wood-based materials | Raw material from certified forests, FSC certificate – authorized companies | | FSC | – | • | | – | • | | |

Sample order VOLPINO ARMCHAIR 4L P (E-WS CC-KK GD FSC)

^③ – Please specify metal colour code – [see finishes](#)

^④ – Please specify plastic colour code – [see finishes](#)

^⑤ – Please specify upholstery colour code from selected price group – [see finishes](#)

• Available as standard (included in basic price)

PRICE GROUP 2: Cura, Cura Loop, Valencia, Xtreme

PRICE GROUP 3: Silvertex, Step/Step Melange

PRICE GROUP 4: Blazer, Main Line Flax, Oceanic, skai Parotega, Synergy

PRICE GROUP 6: Nappa leather

Volpino swivel armchair

Shell made of plastic.
4-star base made of powder-coated or polished aluminium, column made of powder-coated or polished steel.
Plastic glides or castors.



VOLPINO ARMCHAIR SWIVEL P

W 660 mm
D 550 mm
H 820 mm
SH 450 mm
SH DIN 435 mm
WT 9,8 kg

Basic price (EUR)

516

| | | | | | | |
|--------------------------------------|---|-------------------|---------|------|-----|-----|
| Column | Steel | powder-coated | CO-③ | • | | |
| | | chromium plated | | 16 | | |
| Shell | Plastic | | CC-④ | • | | |
| | | None | | • | • | – |
| Backrest pad | Upholstered | Price group | BA-PD-⑤ | 2 | | 121 |
| | | | | 3 | | 130 |
| | | | | 4 | – | 142 |
| | | | | 6 | | 248 |
| | | | | None | • | – |
| Seat pad | Upholstered | Price group | SE-PD-⑤ | 2 | 139 | 139 |
| | | | | 3 | 150 | 150 |
| | | | | 4 | 166 | 166 |
| | | | | 6 | 261 | 261 |
| | | | | None | • | – |
| Base | Aluminium | powder-coated | BC-③ | • | | |
| | | polished | | 22 | | |
| Glides | Glides | Plastic | GD | • | | |
| | | Plastic with felt | GDF | 8 | | |
| | | Plastic nonskid | GDN | 6 | | |
| Foam | Flame retardant foam | | FFR2 | – | • | • |
| | Low flammability foam | | FFR3 | – | 20 | 41 |
| Wood and wood-based materials | Raw material from certified forests, FSC certificate – authorized companies | | FSC | – | • | |

Sample order VOLPINO ARMCHAIR SWIVEL P (CO-CR CC-KF BC_POL GD FSC)

- ③ – Please specify metal colour code – [see finishes](#)
- ④ – Please specify plastic colour code – [see finishes](#)
- ⑤ – Please specify upholstery colour code from selected price group – [see finishes](#)

• Available as standard (included in basic price)

Price list

Volpino swivel armchair

Shell made of plastic.
4-star base made of powder-coated or polished aluminium, column made of powder-coated or polished steel.
Plastic glides or castors.



VOLPINO ARMCHAIR MOB P

W 660 mm
D 550 mm
H 820 mm
SH 450 mm
SH DIN 435 mm
WT 8,4 kg

| | | | | | Basic price (EUR) | | |
|--------------------------------------|---|-----------------|---------------------|------|-------------------|-----|-----|
| | | | | | 516 | | |
| Column | Steel | powder-coated | CO- ^③ | | • | | |
| | | chromium plated | | | 16 | | |
| Shell | Plastic | | CC- ^④ | | • | | |
| Backrest pad | Upholstered | Price group | BA-PD- ^⑤ | None | • | • | – |
| | | | | 2 | | | 121 |
| | | | | 3 | – | – | 130 |
| | | | | 4 | | | 142 |
| | | | | 6 | | | 248 |
| Seat pad | Upholstered | Price group | SE-PD- ^⑤ | None | • | – | – |
| | | | | 2 | | 139 | 139 |
| | | | | 3 | – | 150 | 150 |
| | | | | 4 | | 166 | 166 |
| | | | | 6 | | 261 | 261 |
| Base | Aluminium | powder-coated | BC- ^③ | | • | | |
| | | polished | | | 22 | | |
| Castors | Black castors for soft floors | | GD | | • | | |
| Foam | Flame retardant foam | | FFR2 | – | • | • | |
| | Low flammability foam | | FFR3 | | 20 | | 41 |
| Wood and wood-based materials | Raw material from certified forests, FSC certificate – authorized companies | | FSC | – | | • | |
| Sample order | VOLPINO ARMCHAIR MOB P (CO-CR CC-KF BC-POL CA FSC) | | | | | | |

^③ – Please specify metal colour code – [see finishes](#)

^④ – Please specify plastic colour code – [see finishes](#)

^⑤ – Please specify upholstery colour code from selected price group – [see finishes](#)

• Available as standard (included in basic price)

PRICE GROUP 2: Cura, Cura Loop, Valencia, Xtreme

PRICE GROUP 3: Silvertex, Step/Step Melange

PRICE GROUP 4: Blazer, Main Line Flax, Oceanic, skai Parotega, Synergy

PRICE GROUP 6: Nappa leather

Volpino bench

Shell made of plastic.
Legs made of powder-coated or polished aluminium,
powder-coated beam, plastic glides.



VOLPINO BENCH 2U 4L P

W 1350 mm
D 560 mm
H 830 mm
SH 450 mm
SH DIN 430 mm
WT 17 kg

Basic price (EUR)

997

| | Beam | Legs | | | | | | |
|--------------------------------------|---|-------------------|---------------|------------|--|-----|--|------|
| Frame | | | powder-coated | E-(3)/(3) | | | | • |
| | Powder-coated steel | Aluminium | polished | | | | | 45 |
| Shell | Plastic | | | CC-(4) | | | | • |
| | None | | | | | | | • |
| Backrest pad | Upholstered | Price group | 2 | BA-PD-(5) | | | | 242 |
| | | | 3 | | | | | 260 |
| | | | 4 | | | | | 284 |
| | | | 6 | | | | | 496 |
| Seat pad | Upholstered | Price group | 2 | SE-PD-(5) | | | | 278 |
| | | | 3 | | | | | 300- |
| | | | 4 | | | | | 332 |
| | | | 6 | | | | | 522 |
| Seat-replacing top* | A or B | Resopal traceless | 2 | TF-(7)/(1) | | 229 | | 97 |
| | | | 3 | | | | | 85 |
| | | | 4 | | | | | 67 |
| | | | 6 | | | | | -35 |
| Glides | Plastic | | | GD | | | | • |
| | Plastic nonskid | | | GDN | | | | 8 |
| | Plastic with felt | | | GDF | | | | 6 |
| Foam | Flame retardant foam | | | FFR2 | | | | • |
| | Low flammability foam | | | FFR3 | | | | 40 |
| Wood and wood-based materials | Raw material from certified forests, FSC certificate – authorized companies | | | FSC | | | | • |

Sample order VOLPINO BENCH 2U 4L P (E-BK/BK CC-KK GD FSC)

* stadium shaped top instead of seat, 660 × 420 mm, top thickness 13 mm

- ① – Please specify wood colour code – [see finishes](#)
- ③ – Please specify metal colour code – [see finishes](#)
- ④ – Please specify plastic colour code – [see finishes](#)
- ⑤ – Please specify upholstery colour code from selected price group – [see finishes](#)
- ⑦ – Please specify seat-replacing top position

• Available as standard (included in basic price)

PRICE GROUP 2: Cura, Cura Loop, Valencia, Xtreme
PRICE GROUP 3: Silvertex, Step/Step Melange
PRICE GROUP 4: Blazer, Main Line Flax, Oceanic, skai Parotega, Synergy
PRICE GROUP 6: Nappa leather

Price list

Volpino bench

Shell made of plastic.
Legs made of powder-coated or polished aluminium,
powder-coated beam, plastic glides.



VOLPINO BENCH 3U 4L P

W 2050 mm
D 560 mm
H 830 mm
SH 450 mm
SH DIN 430 mm
WT 22 kg

Basic price (EUR)

1233

| | Beam | Legs | | | | | | |
|--------------------------------------|---|-------------------|---------------|------------|--|-----|--|------|
| Frame | Powder-coated steel | Aluminium | powder-coated | E-(3)/(3) | | | | • |
| | | | polished | | | | | 45 |
| Shell | Plastic | | | CC-(4) | | | | • |
| | None | | | | | | | • |
| Backrest pad | Upholstered | Price group | 2 | BA-PD-(5) | | | | 363 |
| | | | 3 | | | | | 390 |
| | | | 4 | | | | | 426 |
| | | | 6 | | | | | 744- |
| | | | None | | | | | |
| Seat pad | Upholstered | Price group | 2 | SE-PD-(5) | | | | 417 |
| | | | 3 | | | | | 450 |
| | | | 4 | | | | | 498- |
| | | | 6 | | | | | 783 |
| | | | None | | | | | |
| Seat-replacing top* | A, B or C | Resopal traceless | 2 | TF-(7)/(1) | | 229 | | 97 |
| | | | 3 | | | | | 85 |
| | | | 4 | | | | | 67 |
| | | | 6 | | | | | -35 |
| | | | | | | | | -302 |
| Glides | Plastic | | | GD | | | | • |
| | Plastic nonskid | | | GDN | | | | 8 |
| | Plastic with felt | | | GDF | | | | 6 |
| Foam | Flame retardant foam | | | FFR2 | | | | • |
| | Low flammability foam | | | FFR3 | | | | 60 |
| Wood and wood-based materials | Raw material from certified forests, FSC certificate – authorized companies | | | FSC | | | | • |

Sample order VOLPINO BENCH 3U 4L P (E-BK/BK CC-KK GD FSC)

* stadium shaped top instead of seat, 660 × 420 mm, top thickness 13 mm

- ① – Please specify wood colour code – [see finishes](#)
- ③ – Please specify metal colour code – [see finishes](#)
- ④ – Please specify plastic colour code – [see finishes](#)
- ⑤ – Please specify upholstery colour code from selected price group – [see finishes](#)
- ⑦ – Please specify seat-replacing top position

• Available as standard (included in basic price)

PRICE GROUP 2: Cura, Cura Loop, Valencia, Xtreme
PRICE GROUP 3: Silvertex, Step/Step Melange
PRICE GROUP 4: Blazer, Main Line Flax, Oceanic, skai Parotega, Synergy
PRICE GROUP 6: Nappa leather

Volpino bench

Shell made of plastic.
Legs made of powder-coated or polished aluminium,
powder-coated beam, plastic glides.



VOLPINO BENCH 4U 4L P

W 2750 mm
D 560 mm
H 830 mm
SH 450 mm
SH DIN 430 mm
WT 29 kg

Basic price (EUR)

1683

| | Beam | Legs | | | | | | | | |
|--------------------------------------|---|----------------|---------------|-----------|--|--|-----|------|-----|-----|
| Frame | | | powder-coated | E-(3)/(3) | | | | • | | |
| | Powder-coated steel | Aluminium | polished | | | | | 89 | | |
| Shell | Plastic | | | CC-(4) | | | | • | | |
| | None | | | | | | | • | | |
| Backrest pad | Upholstered | Price group | 2 | BA-PD-(5) | | | | 484 | | |
| | | | 3 | | | | | 520 | | |
| | | | 4 | | | | | 568 | | |
| | | | 6 | | | | | 992 | | |
| Seat pad | Upholstered | Price group | 2 | SE-PD-(5) | | | | 556 | | |
| | | | 3 | | | | | 600 | | |
| | | | 4 | | | | | 664 | | |
| | | | 6 | | | | | 1044 | | |
| Seat-replacing top* | None | | | | | | | • | | |
| | Top position (7) | Top finish (1) | Price group | | | | | | | |
| | | | 2 | 97 | | | | | | -33 |
| | | | 3 | 85 | | | | | | -54 |
| | | | 4 | 67 | | | | | | -84 |
| A, B, C or D | Resopal traceless | 6 | TF-(7)/(1) | 229 | | | -35 | -302 | | |
| Glides | Plastic | | | GD | | | | • | | |
| | Plastic nonskid | | | GDN | | | | 12 | | |
| | Plastic with felt | | | GDF | | | | 9 | | |
| Foam | Flame retardant foam | | | FFR2 | | | | • | | |
| | Low flammability foam | | | FFR3 | | | | 80 | 163 | |
| Wood and wood-based materials | Raw material from certified forests, FSC certificate – authorized companies | | | FSC | | | | • | | |

Sample order VOLPINO BENCH 4U 4L P (E-BK/BK CC-KK GD FSC)

* stadium shaped top instead of seat, 660 × 420 mm, top thickness 13 mm

- ① – Please specify wood colour code – [see finishes](#)
- ③ – Please specify metal colour code – [see finishes](#)
- ④ – Please specify plastic colour code – [see finishes](#)
- ⑤ – Please specify upholstery colour code from selected price group – [see finishes](#)
- ⑦ – Please specify seat-replacing top position

• Available as standard (included in basic price)

PRICE GROUP 2: Cura, Cura Loop, Valencia, Xtreme
PRICE GROUP 3: Silvertex, Step/Step Melange
PRICE GROUP 4: Blazer, Main Line Flax, Oceanic, skai Parotega, Synergy
PRICE GROUP 6: Nappa leather

Price list

VOLPINO BENCH 5U 4L P

Volpino bench

Shell made of plastic.
Legs made of powder-coated or polished aluminium,
powder-coated beam, plastic glides.



VOLPINO BENCH 5U 4L P

W 3450 mm
D 560 mm
H 830 mm
SH 450 mm
SH DIN 430 mm
WT 34 kg

Basic price (EUR)

1916

| | Beam | Legs | | | | | | |
|--------------------------------------|---|-------------------|---|------------|--|-----|------|------|
| Frame | Powder-coated steel | Aluminium | powder-coated | E-(3)/(3) | | | • | |
| | | | polished | | | | 89 | |
| Shell | Plastic | | | CC-(4) | | | • | |
| Backrest pad | Upholstered | Price group | None | BA-PD-(5) | | | • | |
| | | | 2 | | | | 605 | |
| | | | 3 | | | | 650 | |
| | | | 4 | | | | 710 | |
| | | | 6 | | | | 1240 | |
| Seat pad | Upholstered | Price group | None | SE-PD-(5) | | | • | |
| | | | 2 | | | | 695 | |
| | | | 3 | | | | 750 | |
| | | | 4 | | | | 830 | |
| | | | 6 | | | | 1305 | |
| Seat-replacing top* | A, B, C, D or E | Resopal traceless | None | TF-(7)/(1) | | 229 | • | |
| | | | Top position (7) Top finish (1) Price group | | | | | |
| | | | 2 | | | | 97 | - 33 |
| | | | 3 | | | | 85 | - 54 |
| | | | 4 | | | | 67 | - 84 |
| 6 | - 35 | - 302 | | | | | | |
| Glides | Plastic | | | GD | | | • | |
| | Plastic nonskid | | | GDN | | | 12 | |
| | Plastic with felt | | | GDF | | | 9 | |
| Foam | Flame retardant foam | | | FFR2 | | | • | |
| | Low flammability foam | | | FFR3 | | | 100 | |
| Wood and wood-based materials | Raw material from certified forests, FSC certificate – authorized companies | | | FSC | | | • | |

Sample order VOLPINO BENCH 5U 4L P (E-BK/BK CC-KK GD FSC)

* stadium shaped top instead of seat, 660 × 420 mm, top thickness 13 mm

- ① – Please specify wood colour code – [see finishes](#)
 - ③ – Please specify metal colour code – [see finishes](#)
 - ④ – Please specify plastic colour code – [see finishes](#)
 - ⑤ – Please specify upholstery colour code from selected price group – [see finishes](#)
 - ⑦ – Please specify seat-replacing top position
- Available as standard (included in basic price)

PRICE GROUP 2: Cura, Cura Loop, Valencia, Xtreme

PRICE GROUP 3: Silvertex, Step/Step Melange

PRICE GROUP 4: Blazer, Main Line Flax, Oceanic, skai Parotega, Synergy

PRICE GROUP 6: Nappa leather

Volpino bench

Shell made of plastic.
Legs made of powder-coated or polished aluminium,
powder-coated beam, plastic glides.



VOLPINO BENCH 6U 4L P

W 4150 mm
D 560 mm
H 830 mm
SH 450 mm
SH DIN 430 mm
WT 39 kg

Basic price (EUR)

2148

| | | | | Basic price (EUR) | | | |
|--------------------------------------|---|-------------------|---------------------------|-------------------|---------|---|------|
| | | | | 2148 | | | |
| Frame | Beam | Legs | | | | | |
| | Powder-coated steel | Aluminium | powder-coated polished | E-(3)/(3) | • 89 | | |
| Shell | Plastic | | | CC-(4) | • | | |
| | None | | | | • | – | |
| Backrest pad | Upholstered | Price group | 2 | BA-PD-(5) | – | – | 726 |
| | | | 3 | | | | 780 |
| | | | 4 | | | | 852 |
| | | | 6 | | | | 1488 |
| Seat pad | Upholstered | Price group | 2 | SE-PD-(5) | – | – | 834 |
| | | | 3 | | | | 900 |
| | | | 4 | | | | 996 |
| | | | 6 | | | | 1566 |
| Seat-replacing top* | A, B, C, D, E or F | Resopal traceless | 2 | TF-(7)/(1) | 229 | | 97 |
| | | | 3 | | | | 85 |
| | | | 4 | | | | 67 |
| | | | 6 | | | | –36 |
| Glides | Plastic | | | GD | • | | |
| | Plastic nonskid | | | GDN | 12 | | |
| | Plastic with felt | | | GDF | 9 | | |
| Foam | Flame retardant foam | | | FFR2 | – | • | |
| | Low flammability foam | | | FFR3 | – | • | |
| Wood and wood-based materials | Raw material from certified forests, FSC certificate – authorized companies | | | FSC | • | | |

Sample order VOLPINO BENCH 6U 4L P (E-BK/BK CC-KK GD FSC)

* stadium shaped top instead of seat, 660 × 420 mm, top thickness 13 mm

- ① – Please specify wood colour code – [see finishes](#)
- ③ – Please specify metal colour code – [see finishes](#)
- ④ – Please specify plastic colour code – [see finishes](#)
- ⑤ – Please specify upholstery colour code from selected price group – [see finishes](#)
- ⑦ – Please specify seat-replacing top position
- Available as standard (included in basic price)

PRICE GROUP 2: Cura, Cura Loop, Valencia, Xtreme
PRICE GROUP 3: Silvertex, Step/Step Melange
PRICE GROUP 4: Blazer, Main Line Flax, Oceanic, skai Parotega, Synergy
PRICE GROUP 6: Nappa leather

Price list

Floor fixing (type 2)

Set of floor fixing elements for benches



BENCH ACCESSORY FF 2

Basic price (EUR)

63

Finishes

Wood

Natural



SKNB
Natural
Beech

Stained



2.07Y
Black



2.06S
Slate



S39
Light Grey

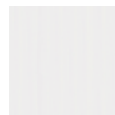

2.09S
White



2.0CB
Acacia



SK40
Oak



2.0CC
Walnut

Metal



RAL 1024
Ochre Yellow
OY



**RAL 030
50 40**
Vermilion
Red
VR



RAL 6003
Olive Green
OG



RAL 5000
Violet Blue
VB



Chrome
CR



**Polished
Aluminium**
POL



RAL 9003
Signal White
WS



Silk
KSK



RAL 9006
White
Aluminium
WK



RAL 9005
Jet Black
BK

Laminate



U0901TP
Traceless
Black

Plastic



KF
Graphite



KKG
Silk Grey

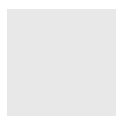

KWT
Traffic White

General notes

All specified dimensions are approximate. Subject to minor modifications or differences for reasons of design improvements or for technical reasons.

- W = width
- D = depth
- H = height
- DI = diameter
- SH = seat height
- SH DIN = seat height measured acc. to DIN EN 1335-1

In compliance with the highest quality standards "Quality is irreplaceable." Guided by this principle, each product line is subjected to stringent quality testing.

Only the products marked in this document are FSC® (FSC®-C120977). Look for our FSC®-certified products. Sale of products that meet the FSC® requirements is possible only by Nowy Styl Sp. z o.o., Nowy Styl Nederland B.V. and Kusch + Co GmbH.



The FSC® certificate applies to responsible forest management and the entire flow of raw materials from the forest to the customer. Each stage of the chain is monitored in terms of social, ecological and economic performance. The product with the FSC® label gives customers a guarantee that the wood used for the production of the product comes from sources managed in a sustainable manner.

Warranty

Manufacturer declares that the products shall be free from defects in material or workmanship. The warranty is given to the original purchaser only, for normal commercial usage. Detailed terms of warranty and warranty periods are available at <https://www.kusch.com/en/warranty>

v-travel price list 2026

V-travel

Design by Justus Kolberg

Sofa



VTRAVEL SOFA
RD UPH



VTRAVEL SOFA
RCR UPH

Airport bench



VTRAVEL BENCH 2U



VTRAVEL BENCH 2U TE1



VTRAVEL BENCH 2U TE2



VTRAVEL BENCH 2U T11



VTRAVEL BENCH 3U



VTRAVEL BENCH 3U TE1



VTRAVEL BENCH 3U TE2



VTRAVEL BENCH 3U T11



VTRAVEL BENCH 4U



VTRAVEL BENCH 4U TE1



VTRAVEL BENCH 4U TE2



VTRAVEL BENCH 4U T11



VTRAVEL BENCH 5U BASIC



VTRAVEL BENCH 5U



VTRAVEL BENCH 5U TE1



VTRAVEL BENCH 5U TE2



VTRAVEL BENCH 5U T11

Airport bench PRM



VTRAVEL BENCH
PRM 2U



VTRAVEL BENCH
PRM 2U TE1



VTRAVEL BENCH
PRM 3U



VTRAVEL BENCH
PRM 3U TE1



VTRAVEL BENCH
PRM 3U T11



VTRAVEL BENCH
PRM 4U



VTRAVEL BENCH
PRM 4U TE1



VTRAVEL BENCH
PRM 4U T11



VTRAVEL BENCH
PRM 5U



VTRAVEL BENCH
PRM 5U TE1



VTRAVEL BENCH
PRM 5U T11

Price list

Sofa V-travel

Polished aluminium legs, upholstered seat/back, plastic glides black grey.

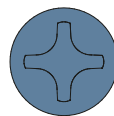

VTRAVEL SOFA RD UPH

W 1440 mm
D 1440 mm
H 800 mm
SH 420 mm
SH DIN 430 mm
WT 35 kg

Basic price (EUR) according to upholstery price group

| | | | |
|--------------------------------------|--|--|------|
| | Price group 4 | | 4084 |
| | Price group 6 | | 5683 |
| Legs | Aluminium | polished | • |
| | | powder-coated | 35 |
| Backrest | Upholstered | E- ^③ | • |
| Seat | Upholstered | BA- ^⑤ | • |
| | None | SE- ^⑤ | • |
| Media | 2 × power socket | J2-YKU1- ^⑧ | 280 |
| | 2 × double USB charger | J2-YKU2- ^⑧ | 620 |
| | 1 × power socket 1 × double USB charger | J1-YKU1- ^⑧ J1-YKU2- ^⑧ | 450 |
| | 4 × power socket | J4-YKU1- ^⑧ | 560 |
| | 4 × double USB charger | J4-YKU2- ^⑧ | 1240 |
| | 2 × power socket 2 × double USB charger | J2-YKU1- ^⑧ J2-YKU2- ^⑧ | 900 |
| | | | |
| Foam | Standard foam | FSTD | • |
| | Flame retardant foam | FFR2 | 174 |
| | Flame retardant foam with fireproof fabric | FFRF | 516 |
| Glides | Plastic | GD | • |
| | Plastic nonskid | GDN | 13 |
| Assembly | Assembled | ASM-F | • |
| | Partially assembled | ASM-P | ◦ |
| Wood and wood-based materials | Raw material – EU Timber regulation | EUTR | • |

Sample order VTRAVEL SOFA RD UPH (E-WK BA-VL4003 SE-VL4003 FSTD GD ASM-F EUTR)

^③ – Please specify metal colour code – [see finishes](#)

^⑤ – Please specify upholstery colour code from selected price group – [see finishes](#)

^⑧ – Please specify media port standard: FR, GB, GE

• Available as standard (included in basic price)

◦ Available as an option (included in basic price)

Sofa V-travel

Polished aluminium legs, upholstered seat/back, plastic glides in black grey colour.

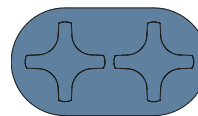

VTRAVEL SOFA RCR UPH

W 2640 mm
D 1440 mm
H 800 mm
SH 420 mm
SH DIN 430 mm
WT 75 kg

Basic price (EUR) according to upholstery price group

| | | | |
|--------------------------------------|--|------------------------|-------|
| | Price group 4 | | 8237 |
| | Price group 6 | | 10500 |
| Legs | Aluminium | polished | • |
| | | powder-coated | 54 |
| Backrest | Upholstered | E-③ | • |
| Seat | Upholstered | BA-⑤ | • |
| Media | None | | • |
| | 4 × power socket | J4-YKU1-⑧ | 560 |
| | 4 × double USB charger | J4-YKU2-⑧ | 1240 |
| | 2 × power socket 2 × double USB charger | J2-YKU1-⑧ J2-YKU2-⑧ | 900 |
| | 6 × power socket | J6-YKU1-⑧ | 840 |
| | 6 × double USB charger | J6-YKU2-⑧ | 1860 |
| | 3 × power socket 3 × double USB charger | J3-YKU1-⑧ J3-YKU2-⑧ | 1350 |
| | | | |
| Foam | Standard foam | FSTD | • |
| | Flame retardant foam | FFR2 | 409 |
| | Flame retardant foam with fireproof fabric | FFRF | 1077 |
| Glides | Plastic | GD | • |
| | Plastic nonskid | GDN | 20 |
| Assembly | Assembled | ASM-F | • |
| | Partially assembled | ASM-P | ○ |
| Wood and wood-based materials | Raw material – EU Timber regulation | EUTR | • |

Sample order VTRAVEL SOFA RCR UPH (E-WK BA-VL0020 SE-VL0020 FSTD GD ASM-F EUTR)

③ – Please specify metal colour code – [see finishes](#)

⑤ – Please specify upholstery colour code from selected price group – [see finishes](#)

⑧ – Please specify media port standard: FR, GB, GE

• Available as standard (included in basic price)

○ Available as an option (included in basic price)

Price list

Floor fixing



**BENCH ACCESSORY
FF 3**

· Adhesive

**BENCH ACCESSORY
FF 4**

· Screwed

Basic price (EUR)

| | | | 123,- | 87,- |
|--------------------|---|------|-------|------|
| Integration | Set of floor fixing elements for round and square bench and for airport benches | IN-S | | |
| | Set of floor fixing elements for rectangular and rectangular rounded bench | IN-L | 184,- | 94,- |

Sample order BENCH ACCESSORY FF 3 (IN-L)

V-Travel bench 2U



VTRAVEL BENCH 2U

W 1275 mm
D 660 mm
H 850 mm
SH 430 mm
SH DIN 400 mm
WT 32,80 kg

Basic price (EUR)

1477

| | Beam | Legs | | | |
|----------------------------|--|---|------------------|-----------|-----|
| Frame | Aluminium anodised | Aluminium polished | E-(3)/(3) | • | |
| | | Aluminium powder-coated | | 38 | |
| Shell | PU foam | | CC-(4) | • | |
| | PU foam with cut-out in back | | CC-CT-(4) | ◦ | |
| | Fully upholstered | Price group | 3 | BS-(5) | 138 |
| | | | 4 | | 204 |
| | | | 6 | | 620 |
| | Fully upholstered with cut-out in back | Price group | 3 | BS-CT-(5) | 256 |
| 4 | | | 320 | | |
| 6 | | | 738 | | |
| Internal armrest | None | | | • | |
| | 1 piece | Aluminium polished | AI-J1-(3) | 105 | |
| | Aluminium powder-coated | 121 | | | |
| External armrests | None | | | • | |
| | 2 pieces | Aluminium polished | AE-J2-(3) | 174 | |
| | Aluminium powder-coated | 204 | | | |
| Media between seats | None | | | • | |
| | 2 modules | 1 × power socket 1 × double USB charger (type A + A) | J1-BS-YKU2M-(8) | 643 | |
| | | 1 × power socket 1 × TUF double USB charger (type A + C) | J1-BS-YKU2MR-(8) | 685 | |
| | 3 modules | 2 × power socket 1 × double USB charger (type A + A) | J1-BS-YKU3M-(8) | 660 | |
| | | 2 × power socket 1 × TUF double USB charger (type A + C) | J1-BS-YKU3MR-(8) | 704 | |
| Cable outlet | None | | | • | |
| | Left | | BO-L | ◦ | |
| | Right | | BO-R | | |

(3) – Please specify metal colour code – [see finishes](#)

(4) – Please specify plastic colour code – [see finishes](#)

(5) – Please specify upholstery colour code from selected price group – [see finishes](#)

(8) – Please specify media port standard: CH13, FR, GB, GE

• Available as standard (included in basic price)

◦ Available as an option (included in basic price)

PRICE GROUP 3: Silvertex
PRICE GROUP 4: Skai Parotega
PRICE GROUP 6: Arona leather

Price list

| | | | VTRAVEL BENCH 2U |
|---|---|-------|------------------|
| Glides | Plastic | GD | • |
| | Plastic nonskid | GDN | 16 |
| | Floor fixing glued | GDG | 66 |
| | Floor fixing screwed | GDS | 46 |
| | Floor fixing magnetic | GDMG | 156 |
| Wall spacer | None | | • |
| | Wall spacer (available only for GD and GDN glides) | IN-WS | 108 |
| Foam (only for upholstered shell) | Flame retardant foam | FFR2 | • |
| | Flame retardant foam with fireproof fabric | FFRF | 126 |
| Assembly | Assembled | ASM-F | • |
| | Unassembled | ASM-U | ◦ |
| Wood and wood-based materials (only for upholstered shell) | Raw material from certified forests, FSC certificate – authorized companies | FSC | • |
| Sample order | VTRAVEL BENCH 2U (E-AA/SA CC-KG AE-J2-SA GD ASM-F FSC) | | |

- Available as standard (included in basic price)
- Available as an option (included in basic price)

V-Travel bench 2U with external table



VTRAVEL BENCH 2U TE1

W 1590 mm
D 660 mm
H 850 mm
SH 430 mm
SH DIN 400 mm
WT 37,60 kg

Basic price (EUR)

1738

| | Beam | Legs | | | | |
|----------------------------|--|---|-----------------------------|---|-------------------------|-----|
| Frame | Aluminium anodised | Aluminium polished | E-(3)/(3) | | • | |
| | | Aluminium powder-coated | | | 38 | |
| Shell | PU foam | | CC-(4) | | • | |
| | PU foam with cut-out in back | | CC-CT-(4) | | ◦ | |
| | Fully upholstered | Price group | 3 | BS-(5) | | 138 |
| | | | 4 | | 204 | |
| | | | 6 | | 620 | |
| | Fully upholstered with cut-out in back | Price group | 3 | BS-CT-(5) | | 256 |
| 4 | | | 320 | | | |
| 6 | | | 738 | | | |
| External table | 1 piece | Left | Laminate Traceless TP black | TE-L-U0901TP | • | |
| | | Right | | TE-R-U0901TP | ◦ | |
| Internal armrest | None | | | | • | |
| | 1 piece | | | Aluminium polished Aluminium powder-coated | AI-J1-(3) 105 121 | |
| External armrests | None | | | | • | |
| | 2 pieces | | | Aluminium polished Aluminium powder-coated | AE-J2-(3) 174 204 | |
| Media between seats | 2 modules | 1 × power socket 1 × double USB charger (type A + A) | J1-BS-YKU2M-(8) | | 643 | |
| | | | | 1 × power socket 1 × TUF double USB charger (type A + C) | J1-BS-YKU2MR-(8) | 685 |
| | 3 modules | 2 × power socket 1 × double USB charger (type A + A) | J1-BS-YKU3M-(8) | | 660 | |
| | | | | 2 × power socket 1 × TUF double USB charger (type A + C) | J1-BS-YKU3MR-(8) | 704 |

(3) – Please specify metal colour code – [see finishes](#)

(4) – Please specify plastic colour code – [see finishes](#)

(5) – Please specify upholstery colour code from selected price group – [see finishes](#)

(8) – Please specify media port standard: CH13, FR, GB, GE

• Available as standard (included in basic price)

◦ Available as an option (included in basic price)

PRICE GROUP 3: Silvertex
PRICE GROUP 4: Skai Parotega
PRICE GROUP 6: Arona leather

Price list

| | | | VTRAVEL BENCH 2U TE1 |
|--|---|--------|----------------------|
| Cable outlet | None | | • |
| | Left | BO-L | ◦ |
| | Right | BO-R | |
| Glides | Plastic | GD | • |
| | Plastic nonskid | GDN | 16 |
| | Floor fixing glued | GDG | 66 |
| | Floor fixing screwed | GDS | 46 |
| | Floor fixing magnetic | GDMG | 156 |
| Wall spacer | None | | • |
| | Wall spacer (available only for GD and GDN glides) | IN-WS | 108 |
| Foam (only for upholstered shell) | Flame retardant foam | FFR2 | • |
| | Flame retardant foam with fireproof fabric | FFRF | 126 |
| Assembly | Assembled | ASM-F | • |
| | Unassembled | ASM-U | ◦ |
| Wood and wood-based materials | Raw material – EU timber regulation, from certified forests, FSC certificate – authorized companies | FSCMIX | • |
| Sample order | VTRAVEL BENCH 2U TE1 (E-AA/SA CC-KG TE-L-U0901TP AE-J2-SA GD ASM-F FSCMIX) | | |

- Available as standard (included in basic price)
- Available as an option (included in basic price)

V-Travel bench 2U with external tables



VTRAVEL BENCH 2U TE2

W 1905 mm
D 660 mm
H 850 mm
SH 430 mm
SH DIN 400 mm
WT 42,30 kg

Basic price (EUR)

1999

| | Beam | Legs | | | | |
|----------------------------|--|-------------------------|---|------------------|-----|-----|
| Frame | Aluminium anodised | Aluminium polished | E-(3)/(3) | | • | |
| | | Aluminium powder-coated | | | 38 | |
| Shell | PU foam | | CC-(4) | | • | |
| | PU foam with cut-out in back | | CC-CT-(4) | | ◦ | |
| | Fully upholstered | Price group | 3 | BS-(5) | | 138 |
| | | | 4 | | 204 | |
| | | | 6 | | 620 | |
| | Fully upholstered with cut-out in back | Price group | 3 | BS-CT-(5) | | 256 |
| 4 | | | 320 | | | |
| 6 | | | 738 | | | |
| External table | 2 pieces | Left and right | Laminate Traceless TP black | TE-LR-U0901TP | • | |
| | | | | | ◦ | |
| Internal armrest | None | | | | • | |
| | 1 piece | | Aluminium polished | AI-J1-(3) | 105 | |
| | | | Aluminium powder-coated | | 121 | |
| External armrests | None | | | | • | |
| | 2 pieces | | Aluminium polished | AE-J2-(3) | 174 | |
| | | | Aluminium powder-coated | | 204 | |
| Media between seats | None | | | | • | |
| | One media port between seats | 2 modules | 1 × power socket 1 × double USB charger (type A + A) | J1-BS-YKU2M-(8) | 643 | |
| | | | 1 × power socket 1 × TUF double USB charger (type A + C) | J1-BS-YKU2MR-(8) | 685 | |
| | One media port between seats | 3 modules | 2 × power socket 1 × double USB charger (type A + A) | J1-BS-YKU3M-(8) | 660 | |
| | | | 2 × power socket 1 × TUF double USB charger (type A + C) | J1-BS-YKU3MR-(8) | 704 | |

(3) – Please specify metal colour code – [see finishes](#)

(4) – Please specify plastic colour code – [see finishes](#)

(5) – Please specify upholstery colour code from selected price group – [see finishes](#)

(8) – Please specify media port standard: CH13, FR, GB, GE

• Available as standard (included in basic price)

◦ Available as an option (included in basic price)

PRICE GROUP 3: Silvertex
PRICE GROUP 4: Skai Parotega
PRICE GROUP 6: Arona leather

Price list

| | | | VTRAVEL BENCH 2U TE2 |
|--|---|--------|----------------------|
| Cable outlet | None | | • |
| | Left | BO-L | ◦ |
| | Right | BO-R | |
| Glides | Plastic | GD | • |
| | Plastic nonskid | GDN | 16 |
| | Floor fixing glued | GDG | 66 |
| | Floor fixing screwed | GDS | 46 |
| | Floor fixing magnetic | GDMG | 156 |
| Wall spacer | None | | • |
| | Wall spacer (available only for GD and GDN glides) | IN-WS | 108 |
| Foam (only for upholstered shell) | Flame retardant foam | FFR2 | • |
| | Flame retardant foam with fireproof fabric | FFRF | 126 |
| Assembly | Assembled | ASM-F | • |
| | Unassembled | ASM-U | ◦ |
| Wood and wood-based materials | Raw material – EU timber regulation, from certified forests, FSC certificate – authorized companies | FSCMIX | • |
| Sample order | VTRAVEL BENCH 2U TE2 (E-AA/SA CC-KG TE-LR-UO901TP AE-J2-SA GD ASM-F FSCMIX) | | |

- Available as standard (included in basic price)
- Available as an option (included in basic price)

V-Travel bench 2U with internal table



VTRAVEL BENCH 2U T11

W 1675 mm
D 660 mm
H 850 mm
SH 430 mm
SH DIN 400 mm
WT 38,90 kg

Basic price (EUR)

1775

| | Beam | Legs | | | |
|---------------------------|--|-----------------------------|---|------------------|-----|
| Frame | Aluminium anodised | Aluminium polished | E-(3)/(3) | • | |
| | | Aluminium powder-coated | | 38 | |
| Shell | PU foam | | CC-(4) | • | |
| | PU foam with cut-out in back | | CC-CT-(4) | ◦ | |
| | Fully upholstered | Price group | 3 | BS-(5) | 138 |
| | | | 4 | | 204 |
| | | | 6 | | 620 |
| | Fully upholstered with cut-out in back | Price group | 3 | BS-CT-(5) | 256 |
| 4 | | | 320 | | |
| 6 | | | 738 | | |
| Internal table | 1 piece | Laminate Traceless TP black | TI-A-U0901TP | • | |
| | None | | | ◦ | |
| Internal armrest | None | | | • | |
| | 2 pieces | Aluminium polished | AI-J2-(3) | 210 | |
| External armrests | None | | | • | |
| | 2 pieces | Aluminium polished | AE-J2-(3) | 174 | |
| | | Aluminium powder-coated | | 204 | |
| Media in table top | One media port in table top | 2 modules | 1 × power socket 1 × double USB charger (type A + A) | J1-TT-YKU2M-(8) | 729 |
| | | | 1 × power socket 1 × TUF double USB charger (type A + C) | J1-TT-YKU2MR-(8) | 771 |

(3) - Please specify metal colour code - [see finishes](#)

(4) - Please specify plastic colour code - [see finishes](#)

(5) - Please specify upholstery colour code from selected price group - [see finishes](#)

(8) - Please specify media port standard: CH13, FR, GB, GE

• Available as standard (included in basic price)

◦ Available as an option (included in basic price)

Price list

| | | | VTRAVEL BENCH 2U T11 |
|--|---|--------|----------------------|
| Cable outlet | None | | • |
| | Left | BO-L | ◦ |
| | Right | BO-R | |
| Glides | Plastic | GD | • |
| | Plastic nonskid | GDN | 16 |
| | Floor fixing glued | GDG | 66 |
| | Floor fixing screwed | GDS | 46 |
| | Floor fixing magnetic | GDMG | 156 |
| Wall spacer | None | | • |
| | Wall spacer (available only for GD and GDN glides) | IN-WS | 108 |
| Foam (only for upholstered shell) | Flame retardant foam | FFR2 | • |
| | Flame retardant foam with fireproof fabric | FFRF | 126 |
| Assembly | Assembled | ASM-F | • |
| | Unassembled | ASM-U | ◦ |
| Wood and wood-based materials | Raw material – EU timber regulation, from certified forests, FSC certificate – authorized companies | FSCMIX | • |
| Sample order | VTRAVEL BENCH 2U T11 (E-AA/SA CC-KG TI-A-U0901TP AE-J2-SA J1-TT-YKU2M-GE BO-L GD ASM-F FSCMIX) | | |

- Available as standard (included in basic price)
- Available as an option (included in basic price)

V-Travel bench 3U



VTRAVEL BENCH 3U

W 1875 mm
D 660 mm
H 850 mm
SH 430 mm
SH DIN 400 mm
WT 47,40 kg

Basic price (EUR)

2077

| Frame | Beam | Legs | | | | |
|----------------------------|--|---|---|------------|------|-----|
| | Aluminium anodised | Aluminium polished | E-(3)/(3) | • | | |
| | | Aluminium powder-coated | | | 38 | |
| Shell | PU foam | | CC-(4) | • | | |
| | PU foam with cut-out in back | | CC-CT-(4) | ◦ | | |
| | | | | | 3 | 207 |
| | Fully upholstered | Price group | | BS-(5) | 4 | 306 |
| | | | | | 6 | 930 |
| | Fully upholstered with cut-out in back | Price group | | BS-CT-(5) | 3 | 384 |
| | | | | 4 | 480 | |
| | | | | 6 | 1107 | |
| Internal armrest | None | | | • | | |
| | 2 pieces | Aluminium polished | AI-J2-(3) | | 210 | |
| | | Aluminium powder-coated | | | 242 | |
| External armrests | None | | | • | | |
| | 2 pieces | Aluminium polished | AE-J2-(3) | | 174 | |
| | | Aluminium powder-coated | | | 204 | |
| Media between seats | None | | | • | | |
| | Two media ports between seats | 2 modules | 1 × power socket | J2-BS- | 1122 | |
| | | | 1 × double USB charger (type A + A) | YKU2M-(8) | | |
| | | | 1 × power socket | J2-BS- | 1206 | |
| | | | 1 × TUF double USB charger (type A + C) | YKU2MR-(8) | | |
| | 3 modules | 2 × power socket | J2-BS- | 1156 | | |
| | | 1 × double USB charger (type A + A) | YKU3M-(8) | | | |
| | | 2 × power socket | J2-BS- | 1244 | | |
| | | 1 × TUF double USB charger (type A + C) | YKU3MR-(8) | | | |

(3) – Please specify metal colour code – [see finishes](#)

(4) – Please specify plastic colour code – [see finishes](#)

(5) – Please specify upholstery colour code from selected price group – [see finishes](#)

(8) – Please specify media port standard: CH13, FR, GB, GE

• Available as standard (included in basic price)

◦ Available as an option (included in basic price)

Price list

| | | | VTRAVEL BENCH 3U |
|---|---|-------|------------------|
| Cable outlet | None | | • |
| | Left | BO-L | ◦ |
| | Right | BO-R | |
| Glides | Plastic | GD | • |
| | Plastic nonskid | GDN | 16 |
| | Floor fixing glued | GDG | 66 |
| | Floor fixing screwed | GDS | 46 |
| | Floor fixing magnetic | GDMG | 156 |
| Wall spacer | None | | • |
| | Wall spacer (available only for GD and GDN glides) | IN-WS | 108 |
| Foam (only for upholstered shell) | Flame retardant foam | FFR2 | • |
| | Flame retardant foam with fireproof fabric | FFRF | 189 |
| Assembly | Assembled | ASM-F | • |
| | Unassembled | ASM-U | ◦ |
| Wood and wood-based materials (only for upholstered shell) | Raw material from certified forests, FSC certificate – authorized companies | FSC | • |
| Sample order | VTRAVEL BENCH 3U (E-AA/SA CC-KG AE-J2-SA GD ASM-F FSC) | | |

- Available as standard (included in basic price)
- Available as an option (included in basic price)

V-Travel bench 3U with external table



VTRAVEL BENCH 3U TE1

W 2190 mm
D 660 mm
H 850 mm
SH 430 mm
SH DIN 400 mm
WT 52,10 kg

Basic price (EUR)

2339

| Frame | | Beam | Legs | | |
|---------------------|--|------------------------------|---|------------------|------|
| | Aluminium anodised | Aluminium polished | | E-(3)/(3) | • |
| | | Aluminium powder-coated | | | 38 |
| | | PU foam | | CC-(4) | • |
| | | PU foam with cut-out in back | | CC-CT-(4) | ◦ |
| Shell | Fully upholstered | Price group | 3 | BS-(5) | 207 |
| | | | 4 | | 306 |
| | | | 6 | | 930 |
| | Fully upholstered with cut-out in back | Price group | 3 | BS-CT-(5) | 384 |
| | | | 4 | | 480 |
| | | | 6 | | 1107 |
| External table | 1 piece | Left | Laminate Traceless TP black | TE-L-U0901TP | • |
| | | Right | | TE-R-U0901TP | ◦ |
| Internal armrest | None | | | | • |
| | 2 pieces | Aluminium polished | | AI-J2-(3) | 210 |
| | | Aluminium powder-coated | | | 242 |
| External armrests | None | | | | • |
| | 2 pieces | Aluminium polished | | AE-J2-(3) | 174 |
| | | Aluminium powder-coated | | | 204 |
| Media between seats | None | | | | • |
| | Two media ports between seats | 2 modules | 1 × power socket 1 × double USB charger (type A + A) | J2-BS-YKU2M-(8) | 1122 |
| | | | 1 × power socket 1 × TUF double USB charger (type A + C) | J2-BS-YKU2MR-(8) | 1206 |
| | Two media ports between seats | 3 modules | 2 × power socket 1 × double USB charger (type A + A) | J2-BS-YKU3M-(8) | 1156 |
| | | | 2 × power socket 1 × TUF double USB charger (type A + C) | J2-BS-YKU3MR-(8) | 1244 |

(3) – Please specify metal colour code – [see finishes](#)

(4) – Please specify plastic colour code – [see finishes](#)

(5) – Please specify upholstery colour code from selected price group – [see finishes](#)

(8) – Please specify media port standard: CH13, FR, GB, GE

- Available as standard (included in basic price)
- Available as an option (included in basic price)

Price list

| | | | VTRAVEL BENCH 3U TE1 |
|-----------------------------------|---|--------|----------------------|
| Cable outlet | None | | • |
| | Left | BO-L | ◦ |
| | Right | BO-R | |
| Glides | Plastic | GD | • |
| | Plastic nonskid | GDN | 16 |
| | Floor fixing glued | GDG | 66 |
| | Floor fixing screwed | GDS | 46 |
| | Floor fixing magnetic | GDMG | 156 |
| Wall spacer | None | | • |
| | Wall spacer (available only for GD and GDN glides) | IN-WS | 108 |
| Foam (only for upholstered shell) | Flame retardant foam | FFR2 | • |
| | Flame retardant foam with fireproof fabric | FFRF | 189 |
| Assembly | Assembled | ASM-F | • |
| | Unassembled | ASM-U | ◦ |
| Wood and wood-based materials | Raw material – EU timber regulation, from certified forests, FSC certificate – authorized companies | FSCMIX | • |
| Sample order | VTRAVEL BENCH 3U TE1 (E-AA/SA CC-KG TE-L-U0901TP AE-J2-SA GD ASM-F FSCMIX) | | |

- Available as standard (included in basic price)
- Available as an option (included in basic price)

V-Travel bench 3U with external tables



VTRAVEL BENCH 3U TE2

W 2505 mm
D 660 mm
H 850 mm
SH 430 mm
SH DIN 400 mm
WT 56,90 kg

Basic price (EUR)

2599

| | Beam | Legs | | | | |
|-------------------------------------|---|-------------------------|---|---------------|------|-----|
| Frame | Aluminium anodised | Aluminium polished | E-(3)/(3) | | • | |
| | | Aluminium powder-coated | | | 38 | |
| Shell | PU foam | | CC-(4) | | • | |
| | PU foam with cut-out in back | | CC-CT-(4) | | ◦ | |
| | Fully upholstered | Price group | 3 | BS-(5) | | 207 |
| | | | 4 | | 306 | |
| | | | 6 | | 930 | |
| | Fully upholstered with cut-out in back | Price group | 3 | BS-CT-(5) | | 384 |
| | | | 4 | | 480 | |
| | | | 6 | | 1107 | |
| External table | 2 pieces | Left and right | Laminate Traceless TP black | TE-LR-U0901TP | • | |
| Internal armrest | None | | | | • | |
| | 2 pieces | | Aluminium polished | AI-J2-(3) | 210 | |
| | | Aluminium powder-coated | 242 | | | |
| External armrests | None | | | | • | |
| | 2 pieces | | Aluminium polished | AE-J2-(3) | 174 | |
| | | Aluminium powder-coated | 204 | | | |
| Media between seats | None | | | | • | |
| | Two media ports between seats | 2 modules | 1 × power socket | J2-BS- | 1122 | |
| | | | 1 × double USB charger (type A + A) | YKU2M-(8) | | |
| | | 3 modules | 1 × power socket | J2-BS- | 1206 | |
| | | | 1 × TUF double USB charger (type A + C) | YKU2MR-(8) | | |
| | 3 modules | 2 × power socket | J2-BS- | 1156 | | |
| 1 × double USB charger (type A + A) | | YKU3M-(8) | | | | |
| 3 modules | 2 × power socket | J2-BS- | 1244 | | | |
| | 1 × TUF double USB charger (type A + C) | YKU3MR-(8) | | | | |

(3) – Please specify metal colour code – [see finishes](#)

(4) – Please specify plastic colour code – [see finishes](#)

(5) – Please specify upholstery colour code from selected price group – [see finishes](#)

(8) – Please specify media port standard: CH13, FR, GB, GE

- Available as standard (included in basic price)
- Available as an option (included in basic price)

Price list

| | | | VTRAVEL BENCH 3U TE2 |
|--|---|--------|----------------------|
| Cable outlet | None | | • |
| | Left | BO-L | ◦ |
| | Right | BO-R | |
| Glides | Plastic | GD | • |
| | Plastic nonskid | GDN | 16 |
| | Floor fixing glued | GDG | 66 |
| | Floor fixing screwed | GDS | 46 |
| | Floor fixing magnetic | GDMG | 156 |
| Wall spacer | None | | • |
| | Wall spacer (available only for GD and GDN glides) | IN-WS | 108 |
| Foam (only for upholstered shell) | Flame retardant foam | FFR2 | • |
| | Flame retardant foam with fireproof fabric | FFRF | 189 |
| Assembly | Assembled | ASM-F | • |
| | Unassembled | ASM-U | ◦ |
| Wood and wood-based materials | Raw material – EU timber regulation, from certified forests, FSC certificate – authorized companies | FSCMIX | • |
| Sample order | VTRAVEL BENCH 3U TE2 (E-AA/SA CC-KG TE-LR-UO901TP AE-J2-SA GD ASM-F FSCMIX) | | |

- Available as standard (included in basic price)
- Available as an option (included in basic price)

V-Travel bench 3U with internal table



VTRAVEL BENCH 3U T11

W 2275 mm
D 660 mm
H 850 mm
SH 430 mm
SH DIN 400 mm
WT 53,50 kg

Basic price (EUR)

2375

| | Beam | Legs | | | | |
|-------------------------------------|---|---|--------------------|--------------|-----|-----|
| Frame | Aluminium anodised | Aluminium polished | E-(3)/(3) | | • | |
| | | Aluminium powder-coated | | | 38 | |
| Shell | PU foam | | CC-(4) | | • | |
| | PU foam with cut-out in back | | CC-CT-(4) | | ◦ | |
| | Fully upholstered | Price group | 3 | BS-(5) | | 207 |
| | | | 4 | | 306 | |
| | | | 6 | | 930 | |
| | Fully upholstered with cut-out in back | Price group | 3 | BS-CT-(5) | | 384 |
| 4 | | | 480 | | | |
| 6 | | | 1107 | | | |
| Internal table | 1 piece | Between seats A/B | Laminate Traceless | TI-A-U0901TP | • | |
| | | Between seats B/C | TP black | TI-B-U0901TP | ◦ | |
| Internal armrest | None | | | | • | |
| | 1 piece | Aluminium polished | AI-J1-(3) | | 105 | |
| | | Aluminium powder-coated | | 121 | | |
| | 3 pieces | Aluminium polished | AI-J3-(3) | | 315 | |
| Aluminium powder-coated | | 363 | | | | |
| External armrests | None | | | | • | |
| | 2 pieces | Aluminium polished | AE-J2-(3) | | 174 | |
| Aluminium powder-coated | | 204 | | | | |
| Media between seats | None | | | | • | |
| | 2 modules | 1 x power socket | J1-BS-YKU2M-(8) | | 838 | |
| | | 1 x double USB charger (type A + A) | | | | |
| | One media port between seats | 1 x power socket | J1-BS-YKU2MR-(8) | | 880 | |
| | | 1 x TUF double USB charger (type A + C) | | | | |
| | 3 modules | 2 x power socket | J1-BS-YKU3M-(8) | | 855 | |
| 1 x double USB charger (type A + A) | | | | | | |
| | 2 x power socket | J1-BS-YKU3MR-(8) | | 899 | | |
| | 1 x TUF double USB charger (type A + C) | | | | | |

(3) – Please specify metal colour code – [see finishes](#)

(4) – Please specify plastic colour code – [see finishes](#)

(5) – Please specify upholstery colour code from selected price group – [see finishes](#)

(8) – Please specify media port standard: CH13, FR, GB, GE

• Available as standard (included in basic price)

◦ Available as an option (included in basic price)

PRICE GROUP 3: Silvertex
PRICE GROUP 4: Skai Parotega
PRICE GROUP 6: Arona leather

Price list

| | | | VTRAVEL BENCH 3U T11 | |
|-------------------------------|---|--|--|-----|
| Media in table top | None | | • | |
| | One media port in table top | 2 modules | 1 x power socket 1 x double USB charger | |
| | | | J1-TT- YKU2M-⑧ | 798 |
| | | 1 x power socket 1 x TUF double USB charger | J1-TT- YKU2MR-⑧ | 840 |
| Cable outlet | None | | • | |
| | Left | | BO-L | ◦ |
| | Right | | BO-R | |
| Glides | Plastic | | GD | • |
| | Plastic nonskid | | GDN | 16 |
| | Floor fixing glued | | GDG | 66 |
| | Floor fixing screwed | | GDS | 46 |
| | Floor fixing magnetic | | GDMG | 156 |
| Wall spacer | None | | | • |
| | Wall spacer (available only for GD and GDN glides) | | IN-WS | 108 |
| Foam (for upholstered shell) | Flame retardant foam | | FFR2 | • |
| | Flame retardant foam with fireproof fabric | | FFRF | 189 |
| Assembly | Assembled | | ASM-F | • |
| | Unassembled | | ASM-U | ◦ |
| Wood and wood-based materials | Raw material – EU timber regulation, from certified forests, FSC certificate – authorized companies | | FSCMIX | • |
| Sample order | VTRAVEL BENCH 3U T11 (E-AA/POL CC-KG TI-A-U0901TP GD ASM-F FSCMIX) | | | |

- Available as standard (included in basic price)
- Available as an option (included in basic price)

V-Travel bench 4U



VTRAVEL BENCH 4U

W 2475 mm
D 660 mm
H 850 mm
SH 430 mm
SH DIN 400 mm
WT 61,90 kg

Basic price (EUR)

2678

| | Beam | Legs | | | |
|----------------------------|--|---|---|------------------|------|
| Frame | Aluminium anodised | Aluminium polished | E-(3)/(3) | • | |
| | | Aluminium powder-coated | | 38 | |
| Shell | PU foam | | CC-(4) | • | |
| | PU foam with cut-out in back | | CC-CT-(4) | ◦ | |
| | Fully upholstered | Price group | 3 | BS-(5) | 276 |
| | | | 4 | | 408 |
| | | | 6 | | 1240 |
| | Fully upholstered with cut-out in back | Price group | 3 | BS-CT-(5) | 512 |
| 4 | | | 640 | | |
| 6 | | | 1476 | | |
| Internal armrest | None | | | • | |
| | 1 piece | Aluminium polished | AI-J1-(3) | 105 | |
| | | Aluminium powder-coated | | 121 | |
| | 3 pieces | Aluminium polished | AI-J3-(3) | 315 | |
| Aluminium powder-coated | | 363 | | | |
| External armrests | None | | | • | |
| | 2 pieces | Aluminium polished | AE-J2-(3) | 174 | |
| | | Aluminium powder-coated | | 204 | |
| Media between seats | None | | | • | |
| | Two media ports between seats | 2 modules | 1 × power socket 1 × double USB charger (type A + A) | J2-BS-YKU2M-(8) | 1196 |
| | | 3 modules | 1 × power socket 1 × TUF double USB charger (type A + C) | J2-BS-YKU2MR-(8) | 1280 |
| | Two media ports between seats | 2 modules | 2 × power socket 1 × double USB charger (type A + A) | J2-BS-YKU3M-(8) | 1230 |
| 3 modules | | 2 × power socket 1 × TUF double USB charger (type A + C) | J2-BS-YKU3MR-(8) | 1318 | |

(3) – Please specify metal colour code – [see finishes](#)

(4) – Please specify plastic colour code – [see finishes](#)

(5) – Please specify upholstery colour code from selected price group – [see finishes](#)

(8) – Please specify media port standard: CH13, FR, GB, GE

• Available as standard (included in basic price)

◦ Available as an option (included in basic price)

PRICE GROUP 3: Silvertex
PRICE GROUP 4: Skai Parotega
PRICE GROUP 6: Arona leather

Price list

| | | | VTRAVEL BENCH 4U |
|---|---|-------|------------------|
| Cable outlet | None | | • |
| | Left | BO-L | ◦ |
| | Right | BO-R | |
| Glides | Plastic | GD | • |
| | Plastic nonskid | GDN | 16 |
| | Floor fixing glued | GDG | 66 |
| | Floor fixing screwed | GDS | 46 |
| | Floor fixing magnetic | GDMG | 156 |
| Wall spacer | None | | • |
| | Wall spacer (available only for GD and GDN glides) | IN-WS | 108 |
| Foam (only for upholstered shell) | Flame retardant foam | FFR2 | • |
| | Flame retardant foam with fireproof fabric | FFRF | 252 |
| Assembly | Assembled | ASM-F | • |
| | Unassembled | ASM-U | ◦ |
| Wood and wood-based materials (only for upholstered shell) | Raw material from certified forests, FSC certificate – authorized companies | FSC | • |
| Sample order | VTRAVEL BENCH 4U (E-AA/SA CC-KG AE-J2-SA GD ASM-F FSC) | | |

- Available as standard (included in basic price)
- Available as an option (included in basic price)

V-Travel bench 4U with external table



VTRAVEL BENCH 4U TE1

W 2790 mm
D 660 mm
H 850 mm
SH 430 mm
SH DIN 400 mm
WT 66,70 kg

Basic price (EUR)

2938

| | Beam | Legs | | | | |
|----------------------------|--|-------------------------|---|------------------|------|-----|
| Frame | Aluminium anodised | Aluminium polished | E-(3)/(3) | | • | |
| | | Aluminium powder-coated | | | 38 | |
| Shell | PU foam | | CC-(4) | | • | |
| | PU foam with cut-out in back | | CC-CT-(4) | | ◦ | |
| | Fully upholstered | Price group | 3 | BS-(5) | | 276 |
| | | | 4 | | 408 | |
| | | | 6 | | 1240 | |
| | Fully upholstered with cut-out in back | Price group | 3 | BS-CT-(5) | | 512 |
| | | | 4 | | 640 | |
| | | | 6 | | 1476 | |
| External table | 1 piece | Left | Laminate Traceless TP black | TE-L-U0901TP | • | |
| | | Right | | TE-R-U0901TP | ◦ | |
| Internal armrest | None | | | | • | |
| | 1 piece | Aluminium polished | AI-J1-(3) | | 105 | |
| | | Aluminium powder-coated | | 121 | | |
| | 3 pieces | Aluminium polished | AI-J3-(3) | | 315 | |
| Aluminium powder-coated | | 363 | | | | |
| External armrests | None | | | | • | |
| | 2 pieces | Aluminium polished | AE-J2-(3) | | 174 | |
| | | Aluminium powder-coated | | 204 | | |
| Media between seats | Two media ports between seats | 2 modules | 1 × power socket 1 × double USB charger (type A + A) | J2-BS-YKU2M-(8) | 1196 | |
| | | | 1 × power socket 1 × TUF double USB charger (type A + C) | J2-BS-YKU2MR-(8) | 1280 | |
| | | 3 modules | 2 × power socket 1 × double USB charger (type A + A) | J2-BS-YKU3M-(8) | 1230 | |
| | | | 2 × power socket 1 × TUF double USB charger (type A + C) | J2-BS-YKU3MR-(8) | 1318 | |

(3) – Please specify metal colour code – see finishes

(4) – Please specify plastic colour code – see finishes

(5) – Please specify upholstery colour code from selected price group – see finishes

(8) – Please specify media port standard: CH13, FR, GB, GE

• Available as standard (included in basic price)

◦ Available as an option (included in basic price)

PRICE GROUP 3: Silvertex
PRICE GROUP 4: Skai Parotega
PRICE GROUP 6: Arona leather

Price list

| | | | VTRAVEL BENCH 4U TE1 |
|--|---|--------|----------------------|
| Cable outlet | None | | • |
| | Left | BO-L | ◦ |
| | Right | BO-R | |
| Glides | Plastic | GD | • |
| | Plastic nonskid | GDN | 16 |
| | Floor fixing glued | GDG | 66 |
| | Floor fixing screwed | GDS | 46 |
| | Floor fixing magnetic | GDMG | 156 |
| Wall spacer | None | | • |
| | Wall spacer (available only for GD and GDN glides) | IN-WS | 108 |
| Foam (only for upholstered shell) | Flame retardant foam | FFR2 | • |
| | Flame retardant foam with fireproof fabric | FFRF | 252 |
| Assembly | Assembled | ASM-F | • |
| | Unassembled | ASM-U | ◦ |
| Wood and wood-based materials | Raw material – EU timber regulation, from certified forests, FSC certificate – authorized companies | FSCMIX | • |
| Sample order | VTRAVEL BENCH 4U TE1 (E-AA/SA CC-KG TE-L-UO901TP AE-J2-SA GD ASM-F FSCMIX) | | |

- Available as standard (included in basic price)
- Available as an option (included in basic price)

V-Travel bench 4U with external tables



VTRAVEL BENCH 4U TE2

W 3105 mm
D 660 mm
H 850 mm
SH 430 mm
SH DIN 400 mm
WT 71,40 kg

Basic price (EUR)

3199

| | Beam | Legs | | | | |
|----------------------------|--|-------------------------|---|------------------|------|-----|
| Frame | Aluminium anodised | Aluminium polished | E-(3)/(3) | | • | |
| | | Aluminium powder-coated | | | 38 | |
| Shell | PU foam | | CC-(4) | | • | |
| | PU foam with cut-out in back | | CC-CT-(4) | | ◦ | |
| | Fully upholstered | Price group | 3 | BS-(5) | | 276 |
| | | | 4 | | 408 | |
| | | | 6 | | 1240 | |
| | Fully upholstered with cut-out in back | Price group | 3 | BS-CT-(5) | | 512 |
| 4 | | | 640 | | | |
| 6 | | | 1476 | | | |
| External table | 2 pieces | Left and right | Laminate Traceless TP black | TE-LR-U0901TP | • | |
| Internal armrest | None | | | | • | |
| | 1 piece | | Aluminium polished | AI-J1-(3) | 105 | |
| | | | Aluminium powder-coated | | 121 | |
| | 3 pieces | | Aluminium polished | AI-J3-(3) | 315 | |
| | | Aluminium powder-coated | 363 | | | |
| External armrests | None | | | | • | |
| | 2 pieces | | Aluminium polished | AE-J2-(3) | 174 | |
| | | | Aluminium powder-coated | | 204 | |
| Media between seats | Two media ports between seats | 2 modules | 1× power socket 1× double USB charger (type A + A) | J2-BS-YKU2M-(8) | 1196 | |
| | | | 1× power socket 1× TUF double USB charger (type A + C) | J2-BS-YKU2MR-(8) | 1280 | |
| | | 3 modules | 2× power socket 1× double USB charger (type A + A) | J2-BS-YKU3M-(8) | 1230 | |
| | | | 2× power socket 1× TUF double USB charger (type A + C) | J2-BS-YKU3MR-(8) | 1318 | |

(3) – Please specify metal colour code – [see finishes](#)

(4) – Please specify plastic colour code – [see finishes](#)

(5) – Please specify upholstery colour code from selected price group – [see finishes](#)

(8) – Please specify media port standard: CH13, FR, GB, GE

• Available as standard (included in basic price)

◦ Available as an option (included in basic price)

PRICE GROUP 3: Silvertex
PRICE GROUP 4: Skai Parotega
PRICE GROUP 6: Arona leather

Price list

| | | | VTRAVEL BENCH 4U TE2 |
|--|---|--------|----------------------|
| Cable outlet | None | | • |
| | Left | BO-L | ◦ |
| | Right | BO-R | |
| Glides | Plastic | GD | • |
| | Plastic nonskid | GDN | 16 |
| | Floor fixing glued | GDG | 66 |
| | Floor fixing screwed | GDS | 46 |
| | Floor fixing magnetic | GDMG | 156 |
| Wall spacer | None | | • |
| | Wall spacer (available only for GD and GDN glides) | IN-WS | 108 |
| Foam (only for upholstered shell) | Flame retardant foam | FFR2 | • |
| | Flame retardant foam with fireproof fabric | FFRF | 252 |
| Assembly | Assembled | ASM-F | • |
| | Unassembled | ASM-U | ◦ |
| Wood and wood-based materials | Raw material – EU timber regulation, from certified forests, FSC certificate – authorized companies | FSCMIX | • |
| Sample order | VTRAVEL BENCH 4U TE2 (E-AA/SA CC-KG TE-LR-U0901TP AE-J2-SA GD ASM-F FSCMIX) | | |

- Available as standard (included in basic price)
- Available as an option (included in basic price)

V-Travel bench 4U with internal table



VTRAVEL BENCH 4U T11

W 2875 mm
D 660 mm
H 850 mm
SH 430 mm
SH DIN 400 mm
WT 68,0 kg

Basic price (EUR)

2975

| | Beam | Legs | | | | | |
|---|--|-------------------------|---|------------------|------|-----------------|------|
| Frame | Aluminium anodised | Aluminium polished | E-(3)/(3) | • | | | |
| | | Aluminium powder-coated | | 38 | | | |
| Shell | PU foam | | CC-(4) | • | | | |
| | PU foam with cut-out in back | | CC-CT-(4) | ◦ | | | |
| | Fully upholstered | Price group | 3 | BS-(5) | 276 | | |
| | | | 4 | | 408 | | |
| | | | 6 | | 1240 | | |
| | Fully upholstered with cut-out in back | Price group | 3 | BS-CT-(5) | 512 | | |
| 4 | | | 640 | | | | |
| 6 | | | 1476 | | | | |
| Internal table | 1 piece | Between seats A/B | Laminate Traceless TP black | TI-A-U0901TP | • | | |
| | | Between seats B/C | | TI-B-U0901TP | ◦ | | |
| | | Between seats C/D | | TI-C-U0901TP | | | |
| Internal armrest | None | | | | • | | |
| | 2 pieces | Aluminium polished | AI-J2-(3) | 210 | | | |
| | | Aluminium powder-coated | | 242 | | | |
| | 4 pieces | Aluminium polished | AI-J4-(3) | 420 | | | |
| Aluminium powder-coated | | 484 | | | | | |
| External armrests | None | | | | • | | |
| | 2 pieces | Aluminium polished | AE-J2-(3) | 174 | | | |
| Aluminium powder-coated | | 204 | | | | | |
| Media between seats | Two media ports between seats | 2 modules | 1 x power socket | J2-BS-YKU2M-(8) | 1317 | | |
| | | | 1 x double USB charger (type A + A) | | | | |
| | | 3 modules | 1 x power socket | J2-BS-YKU2MR-(8) | 1401 | | |
| | | | 1 x TUF double USB charger (type A + C) | | | | |
| | | | 2 x power socket | | | J2-BS-YKU3M-(8) | 1351 |
| | | | 1 x double USB charger (type A + A) | | | | |
| 2 x power socket | J2-BS-YKU3MR-(8) | 1439 | | | | | |
| 1 x TUF double USB charger (type A + C) | | | | | | | |

(3) – Please specify metal colour code – [see finishes](#)

(4) – Please specify plastic colour code – [see finishes](#)

(5) – Please specify upholstery colour code from selected price group – [see finishes](#)

(8) – Please specify media port standard: CH13, FR, GB, GE

• Available as standard (included in basic price)

◦ Available as an option (included in basic price)

PRICE GROUP 3: Silvertex
PRICE GROUP 4: Skai Parotega
PRICE GROUP 6: Arona leather

Price list

| | | | VTRAVEL BENCH 4U T11 | | |
|--------------------------------------|---|-----------|--|--------------------|-----|
| Media in table top | None | | • | | |
| | One media port in table top | 2 modules | 1 x power socket 1 x double USB charger | J1-TT- YKU2M-⑧ | 820 |
| | | | 1 x power socket 1 x TUF double USB charger | J1-TT- YKU2MR-⑧ | 862 |
| Cable outlet | None | | • | | |
| | Left | | BO-L | ◦ | |
| | Right | | BO-R | | |
| Glides | Plastic | | GD | • | |
| | Plastic nonskid | | GDN | 16 | |
| | Floor fixing glued | | GDG | 66 | |
| | Floor fixing screwed | | GDS | 46 | |
| | Floor fixing magnetic | | GDMG | 156 | |
| Wall spacer | None | | | • | |
| | Wall spacer (available only for GD and GDN glides) | | IN-WS | 108 | |
| Foam (for upholstered shell) | Flame retardant foam | | FFR2 | • | |
| | Flame retardant foam with fireproof fabric | | FFRF | 252 | |
| Assembly | Assembled | | ASM-F | • | |
| | Unassembled | | ASM-U | ◦ | |
| Wood and wood-based materials | Raw material – EU timber regulation, from certified forests, FSC certificate – authorized companies | | FSCMIX | • | |
| Sample order | VTRAVEL BENCH 4U T11 (E-AA/POL CC-KG TI-A-U0901TP GD ASM-F FSCMIX) | | | | |

- Available as standard (included in basic price)
- Available as an option (included in basic price)

V-Travel bench 5U basic



VTRAVEL BENCH 5U BASIC

W 3075 mm
D 660 mm
H 850 mm
SH 430 mm
SH DIN 400 mm
WT 76,50 kg

Basic price (EUR)

3278

| | Beam | Legs | | | |
|--------------------------|--|-------------------------|-----------|-----------|------|
| Frame | Aluminium anodised | Aluminium polished | E-(3)/(3) | • | |
| | | Aluminium powder-coated | | 38 | |
| Shell | PU foam | | CC-(4) | • | |
| | PU foam with cut-out in back | | CC-CT-(4) | ◦ | |
| | Fully upholstered | Price group | 3 | BS-(5) | 345 |
| | | | 4 | | 510 |
| | | | 6 | | 1550 |
| | Fully upholstered with cut-out in back | Price group | 3 | BS-CT-(5) | 640 |
| | | | 4 | | 800 |
| | | | 6 | | 1845 |
| Internal armrest | None | | | • | |
| | 2 pieces | Aluminium polished | AI-J2-(3) | 210 | |
| | | Aluminium powder-coated | | 242 | |
| | 4 pieces | Aluminium polished | AI-J4-(3) | 420 | |
| Aluminium powder-coated | | 484 | | | |
| External armrests | None | | | • | |
| | 2 pieces | Aluminium polished | AE-J2-(3) | 174 | |
| Aluminium powder-coated | | 204 | | | |

(3) – Please specify metal colour code – [see finishes](#)

(4) – Please specify plastic colour code – [see finishes](#)

(5) – Please specify upholstery colour code from selected price group – [see finishes](#)

• Available as standard (included in basic price)

◦ Available as an option (included in basic price)

Price list

| | | | VTRAVEL BENCH 5U BASIC |
|---|---|-------|------------------------|
| Glides | Plastic | GD | • |
| | Plastic nonskid | GDN | 16 |
| | Floor fixing glued | GDG | 66 |
| | Floor fixing screwed | GDS | 46 |
| | Floor fixing magnetic | GDMG | 156 |
| Wall spacer | None | | • |
| | Wall spacer (available only for GD and GDN glides) | IN-WS | 108 |
| Foam (only for upholstered shell) | Flame retardant foam | FFR2 | • |
| | Flame retardant foam with fireproof fabric | FFRF | 315 |
| Assembly | Assembled | ASM-F | • |
| | Unassembled | ASM-U | ◦ |
| Wood and wood-based materials (only for upholstered shell) | Raw material from certified forests, FSC certificate – authorized companies | FSC | • |
| Sample order | VTRAVEL BENCH 5U BASIC (E-AA/SA CC-KG AE-J2-SA GD ASM-F FSC) | | |

- Available as standard (included in basic price)
- Available as an option (included in basic price)

V-Travel bench 5U



VTRAVEL BENCH 5U

W 3075 mm
D 660 mm
H 850 mm
SH 430 mm
SH DIN 400 mm
WT 78,20 kg

Basic price (EUR)

3417

| | Beam | Legs | | | |
|----------------------------|--|-------------------------|---|--------------------------|------|
| Frame | Aluminium anodised | Aluminium polished | E-(3)/(3) | • | |
| | | Aluminium powder-coated | | 57 | |
| Shell | PU foam | | CC-(4) | • | |
| | PU foam with cut-out in back | | CC-CT-(4) | ◦ | |
| | Fully upholstered | Price group | 3 | | 345 |
| | | | 4 | BS-(5) | 510 |
| | | | 6 | | 1550 |
| | Fully upholstered with cut-out in back | Price group | 3 | | 640 |
| 4 | | | BS-CT-(5) | 800 | |
| 6 | | | | 1845 | |
| Internal armrest | None | | | • | |
| | 2 pieces | Aluminium polished | AI-J2-(3) | 210 | |
| | | Aluminium powder-coated | | 242 | |
| | 4 pieces | Aluminium polished | AI-J4-(3) | 420 | |
| Aluminium powder-coated | | | 484 | | |
| External armrests | None | | | • | |
| | 2 pieces | Aluminium polished | AE-J2-(3) | 174 | |
| | | Aluminium powder-coated | | 204 | |
| Media between seats | None | | | • | |
| | Two media ports between seats | 2 modules | 1× power socket 1× double USB charger (type A + A) | J2-BS-YKU2M-(8) 1327 | |
| | | 3 modules | 1× power socket 1× TUF double USB charger (type A + C) | J2-BS-YKU2MR-(8) 1411 | |
| | Two media ports between seats | 2 modules | 2× power socket 1× double USB charger (type A + A) | J2-BS-YKU3M-(8) 1361 | |
| | | 3 modules | 2× power socket 1× TUF double USB charger (type A + C) | J2-BS-YKU3MR-(8) 1449 | |

(3) – Please specify metal colour code – [see finishes](#)

(4) – Please specify plastic colour code – [see finishes](#)

(5) – Please specify upholstery colour code from selected price group – [see finishes](#)

(8) – Please specify media port standard: CH13, FR, GB, GE

• Available as standard (included in basic price)

◦ Available as an option (included in basic price)

PRICE GROUP 3: Silvertex
PRICE GROUP 4: Skai Parotega
PRICE GROUP 6: Arona leather

Price list

| | | | VTRAVEL BENCH 5U |
|---|---|-------|------------------|
| Cable outlet | None | | • |
| | Left | BO-L | ◦ |
| | Right | BO-R | |
| Glides | Plastic | GD | • |
| | Plastic nonskid | GDN | 24 |
| | Floor fixing glued | GDG | 66 |
| | Floor fixing screwed | GDS | 46 |
| | Floor fixing magnetic | GDMG | 234 |
| Wall spacer | None | | • |
| | Wall spacer (available only for GD and GDN glides) | IN-WS | 108 |
| Foam (only for upholstered shell) | Flame retardant foam | FFR2 | • |
| | Flame retardant foam with fireproof fabric | FFRF | 315 |
| Assembly | Assembled | ASM-F | • |
| | Unassembled | ASM-U | ◦ |
| Wood and wood-based materials (only for upholstered shell) | Raw material from certified forests, FSC certificate – authorized companies | FSC | • |
| Sample order | VTRAVEL BENCH 5U (E-AA/SA CC-KG AE-J2-SA J2-BS-YKU2M-GE BO-L GD ASM-F FSC) | | |

- Available as standard (included in basic price)
- Available as an option (included in basic price)

V-Travel bench 5U with external table



VTRAVEL BENCH 5U TE1

W 3390 mm
D 660 mm
H 850 mm
SH 430 mm
SH DIN 400 mm
WT 82,90 kg

Basic price (EUR)

3677

| | Beam | Legs | | | | |
|----------------------------|--|-------------------------|---|------------------|------|-----|
| Frame | Aluminium anodised | Aluminium polished | E-(3)/(3) | | • | |
| | | Aluminium powder-coated | | | 57 | |
| Shell | PU foam | | CC-(4) | | • | |
| | PU foam with cut-out in back | | CC-CT-(4) | | ◦ | |
| | Fully upholstered | Price group | 3 | BS-(5) | | 345 |
| | | | 4 | | 510 | |
| | | | 6 | | 1550 | |
| | Fully upholstered with cut-out in back | Price group | 3 | BS-CT-(5) | | 640 |
| | | | 4 | | 800 | |
| | | | 6 | | 1845 | |
| External table | 1 piece | Left | Laminate Traceless TP black | TE-L-U0901TP | • | |
| | | Right | | TE-R-U0901TP | ◦ | |
| Internal armrest | None | | | | • | |
| | 2 pieces | Aluminium polished | AI-J2-(3) | | 210 | |
| | | Aluminium powder-coated | | 242 | | |
| | 4 pieces | Aluminium polished | AI-J4-(3) | | 420 | |
| Aluminium powder-coated | | 484 | | | | |
| External armrests | None | | | | • | |
| | 2 pieces | Aluminium polished | AE-J2-(3) | | 174 | |
| | | Aluminium powder-coated | | 204 | | |
| Media between seats | Two media ports between seats | 2 modules | 1 × power socket 1 × double USB charger (type A + A) | J2-BS-YKU2M-(8) | 1327 | |
| | | | 1 × power socket 1 × TUF double USB charger (type A + C) | J2-BS-YKU2MR-(8) | 1411 | |
| | | 3 modules | 2 × power socket 1 × double USB charger (type A + A) | J2-BS-YKU3M-(8) | 1361 | |
| | | | 2 × power socket 1 × TUF double USB charger (type A + C) | J2-BS-YKU3MR-(8) | 1449 | |

(3) – Please specify metal colour code – [see finishes](#)

(4) – Please specify plastic colour code – [see finishes](#)

(5) – Please specify upholstery colour code from selected price group – [see finishes](#)

(8) – Please specify media port standard: CH13, FR, GB, GE

• Available as standard (included in basic price)

◦ Available as an option (included in basic price)

PRICE GROUP 3: Silververtex
PRICE GROUP 4: Skai Parotega
PRICE GROUP 6: Arona leather

Price list

| | | | VTRAVEL BENCH 5U TE1 |
|--|---|--------|----------------------|
| Cable outlet | None | | • |
| | Left | BO-L | ◦ |
| | Right | BO-R | |
| Glides | Plastic | GD | • |
| | Plastic nonskid | GDN | 24 |
| | Floor fixing glued | GDG | 66 |
| | Floor fixing screwed | GDS | 46 |
| | Floor fixing magnetic | GDMG | 234 |
| Wall spacer | None | | • |
| | Wall spacer (available only for GD and GDN glides) | IN-WS | 108 |
| Foam (only for upholstered shell) | Flame retardant foam | FFR2 | • |
| | Flame retardant foam with fireproof fabric | FFRF | 315 |
| Assembly | Assembled | ASM-F | • |
| | Unassembled | ASM-U | ◦ |
| Wood and wood-based materials | Raw material – EU timber regulation, from certified forests, FSC certificate – authorized companies | FSCMIX | • |
| Sample order | VTRAVEL BENCH 5U TE1 (E-AA/SA CC-KG TE-L-U0901TP AE-J2-SA J2-BS-YKU2M-GE BO-L GD ASM-F FSCMIX) | | |

- Available as standard (included in basic price)
- Available as an option (included in basic price)

V-Travel bench 5U with external tables



VTRAVEL BENCH 5U TE2

W 3705 mm
D 660 mm
H 850 mm
SH 430 mm
SH DIN 400 mm
WT 87,70 kg

Basic price (EUR)

3938

| | Beam | Legs | | | | |
|----------------------------|--|-------------------------|---|------------------|------|------|
| Frame | Aluminium anodised | Aluminium polished | E-(3)/(3) | | • | |
| | | Aluminium powder-coated | | | 57 | |
| Shell | PU foam | | CC-(4) | | • | |
| | PU foam with cut-out in back | | CC-CT-(4) | | ◦ | |
| | Fully upholstered | Price group | 3 | BS-(5) | | 345 |
| | | | 4 | | | 510 |
| | | | 6 | | | 1550 |
| | Fully upholstered with cut-out in back | Price group | 3 | BS-CT-(5) | | 640 |
| 4 | | | | | 800 | |
| 6 | | | | | 1845 | |
| External table | 2 pieces | Left and right | Laminate Traceless TP black | TE-LR-U0901TP | • | |
| | None | | | | • | |
| Internal armrest | 2 pieces | | Aluminium polished | AI-J1-(3) | 210 | |
| | | | Aluminium powder-coated | | 242 | |
| | 4 pieces | | Aluminium polished | AI-J3-(3) | 420 | |
| | | | Aluminium powder-coated | | 484 | |
| External armrests | None | | | | • | |
| | 2 pieces | | Aluminium polished | AE-J2-(3) | 174 | |
| | | | Aluminium powder-coated | | 204 | |
| Media between seats | Two media ports between seats | 2 modules | 1× power socket 1× double USB charger (type A + A) | J2-BS-YKU2M-(8) | 1327 | |
| | | | 1× power socket 1× TUF double USB charger (type A + C) | J2-BS-YKU2MR-(8) | 1411 | |
| | | 3 modules | 2× power socket 1× double USB charger (type A + A) | J2-BS-YKU3M-(8) | 1361 | |
| | | | 2× power socket 1× TUF double USB charger (type A + C) | J2-BS-YKU3MR-(8) | 1449 | |

(3) – Please specify metal colour code – [see finishes](#)

(4) – Please specify plastic colour code – [see finishes](#)

(5) – Please specify upholstery colour code from selected price group – [see finishes](#)

(8) – Please specify media port standard: CH13, FR, GB, GE

• Available as standard (included in basic price)

◦ Available as an option (included in basic price)

PRICE GROUP 3: Silvertex
PRICE GROUP 4: Skai Parotega
PRICE GROUP 6: Arona leather

Price list

| | | | VTRAVEL BENCH 5U TE2 |
|--|---|--------|----------------------|
| Cable outlet | None | | • |
| | Left | BO-L | ◦ |
| | Right | BO-R | |
| Glides | Plastic | GD | • |
| | Plastic nonskid | GDN | 24 |
| | Floor fixing glued | GDG | 66 |
| | Floor fixing screwed | GDS | 46 |
| | Floor fixing magnetic | GDMG | 234 |
| Wall spacer | None | | • |
| | Wall spacer (available only for GD and GDN glides) | IN-WS | 108 |
| Foam (only for upholstered shell) | Flame retardant foam | FFR2 | • |
| | Flame retardant foam with fireproof fabric | FFRF | 315 |
| Assembly | Assembled | ASM-F | • |
| | Unassembled | ASM-U | ◦ |
| Wood and wood-based materials | Raw material – EU timber regulation, from certified forests, FSC certificate – authorized companies | FSCMIX | • |
| Sample order | VTRAVEL BENCH 5U TE2 (E-AA/SA CC-KG TE-LR-UO901TP AE-J2-SA J2-BS-YKU2M-GE BO-L GD ASM-F FSCMIX) | | |

- Available as standard (included in basic price)
- Available as an option (included in basic price)

V-Travel bench 5U with internal table



VTRAVEL BENCH 5U T11

W 3475 mm
D 660 mm
H 850 mm
SH 430 mm
SH DIN 400 mm
WT 84,30 kg

Basic price (EUR)

3714

| | Beam | Legs | | | |
|----------------------------|--|-------------------------|---|------------------|------|
| Frame | Aluminium anodised | Aluminium polished | E-(3)/(3) | • | |
| | | Aluminium powder-coated | | 57 | |
| Shell | PU foam | | CC-(4) | • | |
| | PU foam with cut-out in back | | CC-CT-(4) | ◦ | |
| | Fully upholstered | Price group | 3 | BS-(5) | 345 |
| | | | 4 | | 510 |
| | | | 6 | | 1550 |
| | Fully upholstered with cut-out in back | Price group | 3 | BS-CT-(5) | 640 |
| 4 | | | 800 | | |
| 6 | | | 1845 | | |
| Internal table | 1 piece | Between seats A/B | TI-A-U0901TP | • | |
| | | Between seats B/C | Laminate Traceless TP black | TI-B-U0901TP | |
| | | Between seats C/D | | TI-C-U0901TP | ◦ |
| | | Between seats D/E | TI-D-U0901TP | | |
| Internal armrest | None | | | • | |
| | 3 pieces | Aluminium polished | AI-J3-(3) | 315 | |
| | | Aluminium powder-coated | | 363 | |
| | 5 pieces | Aluminium polished | AI-J5-(3) | 525 | |
| Aluminium powder-coated | | 605 | | | |
| External armrests | None | | | • | |
| | 2 pieces | Aluminium polished | AE-J2-(3) | 174 | |
| Aluminium powder-coated | | 204 | | | |
| Media between seats | Two media ports between seats | 2 modules | 1 x power socket 1 x double USB charger (type A + A) | J2-BS-YKU2M-(8) | 1391 |
| | | | 1 x power socket 1 x TUF double USB charger (type A + C) | J2-BS-YKU2MR-(8) | 1475 |
| | | 3 modules | 2 x power socket 1 x double USB charger (type A + A) | J2-BS-YKU3M-(8) | 1425 |
| | | | 2 x power socket 1 x TUF double USB charger (type A + C) | J2-BS-YKU3MR-(8) | 1513 |
| | | | | | |

(3) – Please specify metal colour code – [see finishes](#)

(4) – Please specify plastic colour code – [see finishes](#)

(5) – Please specify upholstery colour code from selected price group – [see finishes](#)

(8) – Please specify media port standard: CH13, FR, GB, GE

• Available as standard (included in basic price)

◦ Available as an option (included in basic price)

PRICE GROUP 3: Silvertex
PRICE GROUP 4: Skai Parotega
PRICE GROUP 6: Arona leather

Price list

| | | | | VTRAVEL BENCH 5U T11 | |
|-------------------------------|---|-----------|--|----------------------|-----|
| Media in table top | None | | | • | |
| | One media port in table top | 2 modules | 1 x power socket 1 x double USB charger | J1-TT- YKU2M-⑧ | 951 |
| | | | 1 x power socket 1 x TUF double USB charger | J1-TT- YKU2MR-⑧ | 993 |
| Cable outlet | None | | | • | |
| | Left | | BO-L | ◦ | |
| | Right | | BO-R | | |
| Glides | Plastic | | GD | • | |
| | Plastic nonskid | | GDN | 24 | |
| | Floor fixing glued | | GDG | 66 | |
| | Floor fixing screwed | | GDS | 46 | |
| | Floor fixing magnetic | | GDMG | 234 | |
| Wall spacer | None | | | • | |
| | Wall spacer (available only for GD and GDN glides) | | IN-WS | 108 | |
| Foam (for upholstered shell) | Flame retardant foam | | FFR2 | • | |
| | Flame retardant foam with fireproof fabric | | FFRF | 315 | |
| Assembly | Assembled | | ASM-F | • | |
| | Unassembled | | ASM-U | ◦ | |
| Wood and wood-based materials | Raw material – EU timber regulation, from certified forests, FSC certificate – authorized companies | | FSCMIX | • | |
| Sample order | VTRAVEL BENCH 5U T11 (E-AA/POL CC-KG TI-A-U0901TP GD ASM-F FSCMIX) | | | | |

- Available as standard (included in basic price)
- Available as an option (included in basic price)

V-Travel bench PRM 2U



VTRAVEL BENCH PRM 2U

W 1275 mm
D 660 mm
H 900 mm
SH 465 mm
SH DIN 435 mm
WT 34,50 kg

Basic price (EUR)

1674

| Frame | | Beam | Legs | | |
|------------|--|------------------------------|------|-----------------|-----|
| | Aluminium anodised | Aluminium polished | | E-(3)/(3) | • |
| | | Aluminium powder-coated | | | 38 |
| Shell | | PU foam | | CC-(4) | • |
| | | PU foam with cut-out in back | | CC-CT-(4) | ◦ |
| | Fully upholstered | Price group | 3 | BS-(5) | 69 |
| | | | 4 | | 102 |
| | | | 6 | | 310 |
| | Fully upholstered with cut-out in back | Price group | 3 | BS-CT-(5) | 128 |
| | | | 4 | | 160 |
| | | | 6 | | 369 |
| PRM seat | | PU foam | | PRM-A-CC-(4) | • |
| | | PU foam with cut-out in back | | PRM-A-CC-CT-(4) | ◦ |
| Position A | Fully upholstered | Price group | 3 | PRM-A-BS-(5) | 69 |
| | | | 4 | | 102 |
| | | | 6 | | 310 |
| | Fully upholstered with cut-out in back | Price group | 3 | PRM-A-BS-CT-(5) | 128 |
| | | | 4 | | 160 |
| | | | 6 | | 369 |
| PRM seat | | PU foam | | PRM-B-CC-(4) | ◦ |
| | | PU foam with cut-out in back | | PRM-B-CC-CT-(4) | ◦ |
| Position B | Fully upholstered | Price group | 3 | PRM-B-BS-(5) | 69 |
| | | | 4 | | 102 |
| | | | 6 | | 310 |
| | Fully upholstered with cut-out in back | Price group | 3 | PRM-B-BS-CT-(5) | 128 |
| | | | 4 | | 160 |
| | | | 6 | | 369 |

③ – Please specify metal colour code – [see finishes](#)

④ – Please specify plastic colour code – [see finishes](#)

⑤ – Please specify upholstery colour code from selected price group – [see finishes](#)

- Available as standard (included in basic price)
- Available as an option (included in basic price)

PRICE GROUP 3: Silvertex
PRICE GROUP 4: Skai Parotega
PRICE GROUP 6: Arona leather

Price list

| | | | | VTRAVEL BENCH PRM 2U | |
|--|---|---|---|----------------------|-----|
| PRM logo | None | | | • | |
| | Logo | | LOGO | ◦ | |
| Internal armrest | None | | | • | |
| | 1 piece | Aluminium polished | AI-J1-③ | 105 | |
| | | Aluminium powder-coated | | 121 | |
| External armrests | None | | | • | |
| | 2 pieces | Aluminium polished | AE-J2-③ | 174 | |
| | | Aluminium powder-coated | | 204 | |
| Media between seats | 2 modules | 1× power socket 1× double USB charger (type A + A) | J1-BS-YKU2M-⑧ | 643 | |
| | | 1× power socket 1× TUF double USB charger (type A + C) | J1-BS-YKU2MR-⑧ | 685 | |
| | One media port between seats | 2× power socket 1× double USB charger (type A + A) | J1-BS-YKU3M-⑧ | 660 | |
| | | 3 modules | 2× power socket 1× TUF double USB charger (type A + C) | J1-BS-YKU3MR-⑧ | 704 |
| | | | | | |
| Cable outlet | None | | | • | |
| | Left | | BO-L | ◦ | |
| | Right | | BO-R | | |
| Glides | Plastic | | GD | • | |
| | Plastic nonskid | | GDN | 16 | |
| | Floor fixing glued | | GDG | 66 | |
| | Floor fixing screwed | | GDS | 46 | |
| | Floor fixing magnetic | | GDMG | 156 | |
| Wall spacer | None | | | • | |
| | Wall spacer (available only for GD and GDN glides) | | IN-WS | 108 | |
| Foam (only for upholstered shell) | Flame retardant foam | | FFR2 | • | |
| | Flame retardant foam with fireproof fabric | | FFRF | 126 | |
| Assembly | Assembled | | ASM-F | • | |
| | Unassembled | | ASM-U | ◦ | |
| Wood and wood-based materials (only for upholstered shell) | Raw material from certified forests, FSC certificate – authorized companies | | FSC | • | |
| Sample order | VTRAVEL BENCH PRM 2U (E-AA/SA CC-KG PRM-B-CC-KG GD ASM-F FSC) | | | | |

③ – Please specify metal colour code – see finishes

⑧ – Please specify media port standard: CH13, FR, GB, GE

• Available as standard (included in basic price)

◦ Available as an option (included in basic price)

V-Travel bench PRM 2U with external table



VTRAVEL BENCH PRM 2U TE1

W 1590 mm
D 660 mm
H 900 mm
SH 465mm
SH DIN 435 mm
WT 39,30 kg

Basic price (EUR)

1935

| Frame | Beam | Legs | | | | |
|--|--|------------------------------|-----------------|--------------|-----------------|-----|
| | Aluminium anodised | Aluminium polished | | E-(3)/(3) | • | |
| | | Aluminium powder-coated | | | 38 | |
| Shell | PU foam | | | CC-(4) | • | |
| | PU foam with cut-out in back | | | CC-CT-(4) | ◦ | |
| | Fully upholstered | Price group | 3 | BS-(5) | 69 | |
| | | | 4 | | 102 | |
| | | | 6 | | 310 | |
| | Fully upholstered with cut-out in back | Price group | 3 | BS-CT-(5) | 128 | |
| | | | 4 | | 160 | |
| | | | 6 | | 369 | |
| | PRM seat | PU foam | | | PRM-A-CC-(4) | • |
| | | PU foam with cut-out in back | | | PRM-A-CC-CT-(4) | ◦ |
| Position A | | Fully upholstered | Price group | PRM-A-BS-(5) | 3 | 69 |
| | | | | | 4 | 102 |
| | | | | | 6 | 310 |
| Fully upholstered with cut-out in back | | Price group | PRM-A-BS-CT-(5) | 3 | 128 | |
| | | | | 4 | 160 | |
| | | | | 6 | 369 | |
| PU foam | | | PRM-B-CC-(4) | • | | |
| PU foam with cut-out in back | | | PRM-B-CC-CT-(4) | ◦ | | |
| Position B | | Fully upholstered | Price group | PRM-B-BS-(5) | 3 | 69 |
| | | | | | 4 | 102 |
| | 6 | | | | 310 | |
| Fully upholstered with cut-out in back | Price group | PRM-B-BS-CT-(5) | 3 | 128 | | |
| | | | 4 | 160 | | |
| | | | 6 | 369 | | |

(3) – Please specify metal colour code – [see finishes](#)

(4) – Please specify plastic colour code – [see finishes](#)

(5) – Please specify upholstery colour code from selected price group – [see finishes](#)

• Available as standard (included in basic price)

◦ Available as an option (included in basic price)

PRICE GROUP 3: Silvertex
PRICE GROUP 4: Skai Parotega
PRICE GROUP 6: Arona leather

Price list

| | | | | VTRAVEL BENCH PRM 2U TE1 | |
|--|---|-------------------------|---|--------------------------|-----|
| PRM logo | None | | | • | |
| | Logo | | LOGO | ◦ | |
| External table | 1 piece | Left | TE-L-U0901TP | • | |
| | | Right | TE-R-U0901TP | ◦ | |
| Internal armrest | 1 piece | Aluminium polished | AI-J1-③ | 105 | |
| | | Aluminium powder-coated | | 121 | |
| External armrests | 2 pieces | Aluminium polished | AE-J2-③ | 174 | |
| | | Aluminium powder-coated | | 204 | |
| Media between seats | One media port between seats | 2 modules | 1 × power socket 1 × double USB charger (type A + A) | J1-BS-YKU2M-⑧ | 643 |
| | | | 1 × power socket 1 × TUF double USB charger (type A + C) | J1-BS-YKU2MR-⑧ | 685 |
| | | 3 modules | 2 × power socket 1 × double USB charger (type A + A) | J1-BS-YKU3M-⑧ | 660 |
| | | | 2 × power socket 1 × TUF double USB charger (type A + C) | J1-BS-YKU3MR-⑧ | 704 |
| Cable outlet | None | | | • | |
| | Left | | BO-L | ◦ | |
| | Right | | BO-R | | |
| Glides | Plastic | | GD | • | |
| | Plastic nonskid | | GDN | 16 | |
| | Floor fixing glued | | GDG | 66 | |
| | Floor fixing screwed | | GDS | 46 | |
| | Floor fixing magnetic | | GDMG | 156 | |
| Wall spacer | None | | | • | |
| | Wall spacer (available only for GD and GDN glides) | | IN-WS | 108 | |
| Foam (only for upholstered shell) | Flame retardant foam | | FFR2 | • | |
| | Flame retardant foam with fireproof fabric | | FFRF | 126 | |
| Assembly | Assembled | | ASM-F | • | |
| | Unassembled | | ASM-U | ◦ | |
| Wood and wood-based materials | Raw material – EU timber regulation, from certified forests, FSC certificate – authorized companies | | FSCMIX | • | |
| Sample order | VTRAVEL BENCH PRM 2U TE1 (E-AA/SA CC-KG PRM-B-CC-KG TE-L-U0901TP GD ASM-F FSCMIX) | | | | |

③ – Please specify metal colour code – [see finishes](#)

⑧ – Please specify media port standard: CH13, FR, GB, GE

• Available as standard (included in basic price)

◦ Available as an option (included in basic price)

V-Travel bench PRM 3U



VTRAVEL BENCH PRM 3U

W 1875 mm
D 660 mm
H 900 mm
SH 465 mm
SH DIN 435 mm
WT 49,10 kg

Basic price (EUR)

2274

| Frame | | Beam | Legs | | | |
|------------|--|------------------------------|------------------------------|-----------------|-----------------|---|
| | Aluminium anodised | Aluminium polished | | E-(3)/(3) | • | |
| | | Aluminium powder-coated | | | 38 | |
| Shell | | PU foam | | CC-(4) | • | |
| | | PU foam with cut-out in back | | CC-CT-(4) | ◦ | |
| | Fully upholstered | Price group | 3 | BS-(5) | 138 | |
| | | | 4 | | 204 | |
| | | | 6 | | 620 | |
| | Fully upholstered with cut-out in back | Price group | 3 | BS-CT-(5) | 256 | |
| | | | 4 | | 320 | |
| | | | 6 | | 738 | |
| PRM seat | | PU foam | | PRM-A-CC-(4) | • | |
| | | PU foam with cut-out in back | | PRM-A-CC-CT-(4) | ◦ | |
| Position A | Fully upholstered | Price group | 3 | PRM-A-BS-(5) | 69 | |
| | | | 4 | | 102 | |
| | | | 6 | | 310 | |
| | Fully upholstered with cut-out in back | Price group | 3 | PRM-A-BS-CT-(5) | 128 | |
| | | | 4 | | 160 | |
| | | | 6 | | 369 | |
| | PRM seat | | PU foam | | PRM-C-CC-(5) | • |
| | | | PU foam with cut-out in back | | PRM-C-CC-CT-(5) | ◦ |
| Position C | Fully upholstered | Price group | 3 | PRM-C-BS-(5) | 69 | |
| | | | 4 | | 102 | |
| | Fully upholstered with cut-out in back | Price group | 3 | PRM-C-BS-CT-(5) | 128 | |
| | | | 4 | | 160 | |
| | | | | 6 | 369 | |

(3) – Please specify metal colour code – [see finishes](#)

(4) – Please specify plastic colour code – [see finishes](#)

(5) – Please specify upholstery colour code from selected price group – [see finishes](#)

- Available as standard (included in basic price)
- Available as an option (included in basic price)

PRICE GROUP 3: Silvertex
PRICE GROUP 4: Skai Parotega
PRICE GROUP 6: Arona leather

Price list

| | | | | VTRAVEL BENCH PRM 3U | |
|---|---|-------------------------|---|--------------------------------|------|
| PRM logo | None | | | • | |
| | Logo | | LOGO | ◦ | |
| Internal armrest | None | | | • | |
| | 1 piece | Aluminium polished | AI-J1- ^③ | 105 | |
| | | Aluminium powder-coated | | 121 | |
| | 2 pieces | Aluminium polished | AI-J2- ^③ | 210 | |
| Aluminium powder-coated | | | 242 | | |
| External armrests | None | | | • | |
| | 2 pieces | Aluminium polished | AE-J2- ^③ | 174 | |
| | | Aluminium powder-coated | | 204 | |
| Media between seats | None | | | • | |
| | Two media ports between seats | 2 modules | 1 × power socket 1 × double USB charger (type A + A) | J2-BS- YKU2M- ^⑧ | 1122 |
| | | | 1 × power socket 1 × TUF double USB charger (type A + C) | J2-BS- YKU2MR- ^⑧ | 1206 |
| | Two media ports between seats | 3 modules | 2 × power socket 1 × double USB charger (type A + A) | J2-BS- YKU3M- ^⑧ | 1156 |
| | | | 2 × power socket 1 × TUF double USB charger (type A + C) | J2-BS- YKU3MR- ^⑧ | 1244 |
| Cable outlet | None | | | • | |
| | Left | | BO-L | ◦ | |
| | Right | | BO-R | | |
| Glides | Plastic | | GD | • | |
| | Plastic nonskid | | GDN | 16 | |
| | Floor fixing glued | | GDG | 66 | |
| | Floor fixing screwed | | GDS | 46 | |
| | Floor fixing magnetic | | GDMG | 156 | |
| Wall spacer | None | | | • | |
| | Wall spacer (available only for GD and GDN glides) | | IN-WS | 108 | |
| Foam (only for upholstered shell) | Flame retardant foam | | FFR2 | • | |
| | Flame retardant foam with fireproof fabric | | FFRF | 189 | |
| Assembly | Assembled | | ASM-F | • | |
| | Unassembled | | ASM-U | ◦ | |
| Wood and wood-based materials (only for upholstered shell) | Raw material from certified forests, FSC certificate – authorized companies | | FSC | • | |
| Sample order | VTRAVEL BENCH PRM 3U (E-AA/SA CC-KG PRM-C-CC-KG GD ASM-F FSC) | | | | |

^③ – Please specify metal colour code – [see finishes](#)

^⑧ – Please specify media port standard: CH13, FR, GB, GE

• Available as standard (included in basic price)

◦ Available as an option (included in basic price)

V-Travel bench PRM 3U with external table



VTRAVEL BENCH PRM 3U TE1

W 2190 mm
D 660 mm
H 900 mm
SH 465 mm
SH DIN 435 mm
WT 53,80 kg

Basic price (EUR)

2536

| Frame | | Beam | Legs | | | |
|----------|--|--|------------------------------|-----------------|-----------------|-----|
| | Aluminium anodised | Aluminium polished | | E-(3)/(3) | • | |
| | | Aluminium powder-coated | | | 38 | |
| | | PU foam | | CC-(4) | • | |
| | | PU foam with cut-out in back | | CC-CT-(4) | ◦ | |
| Shell | Fully upholstered | Price group | 3 | BS-(5) | 138 | |
| | | | 4 | | 204 | |
| | | | 6 | | 620 | |
| | Fully upholstered with cut-out in back | Price group | 3 | BS-CT-(5) | 256 | |
| | | | 4 | | 320 | |
| | | | 6 | | 738 | |
| | | PU foam | | PRM-A-CC-(4) | • | |
| | | PU foam with cut-out in back | | PRM-A-CC-CT-(4) | ◦ | |
| PRM seat | Position A | Fully upholstered | Price group | 3 | PRM-A-BS-(5) | 69 |
| | | | | 4 | | 102 |
| | | | | 6 | | 310 |
| | | Fully upholstered with cut-out in back | Price group | 3 | PRM-A-BS-CT-(5) | 128 |
| | | | | 4 | | 160 |
| | | | | 6 | | 369 |
| | | | PU foam | | PRM-C-CC-(5) | • |
| | | | PU foam with cut-out in back | | PRM-C-CC-CT-(5) | ◦ |
| | Position C | Fully upholstered | Price group | 3 | PRM-C-BS-(5) | 69 |
| | | | | 4 | | 102 |
| | | | | 6 | | 310 |
| | | Fully upholstered with cut-out in back | Price group | 3 | PRM-C-BS-CT-(5) | 128 |
| 4 | | | | 160 | | |
| 6 | | | | 369 | | |

③ – Please specify metal colour code – [see finishes](#)

④ – Please specify plastic colour code – [see finishes](#)

⑤ – Please specify upholstery colour code from selected price group – [see finishes](#)

- Available as standard (included in basic price)
- Available as an option (included in basic price)

PRICE GROUP 3: Silvertex
PRICE GROUP 4: Skai Parotega
PRICE GROUP 6: Arona leather

Price list

| | | | | VTRAVEL BENCH PRM 3U TE1 | |
|--|---|-------------------------|---|--------------------------|------|
| PRM logo | None | | | • | |
| | Logo | | LOGO | ◦ | |
| External table | 1 piece | Left | TE-L-U0901TP | • | |
| | | Right | TE-R-U0901TP | ◦ | |
| Internal armrest | None | | | • | |
| | 1 piece | Aluminium polished | AI-J1-③ | 105 | |
| | | Aluminium powder-coated | | 121 | |
| | 2 pieces | Aluminium polished | AI-J2-③ | 210 | |
| Aluminium powder-coated | | | 242 | | |
| External armrests | None | | | • | |
| | 2 pieces | Aluminium polished | AE-J2-③ | 174 | |
| | | Aluminium powder-coated | | 204 | |
| Media between seats | Two media ports between seats | 2 modules | 1× power socket 1× double USB charger (type A + A) | J2-BS-YKU2M-⑧ | 1122 |
| | | | 1× power socket 1× TUF double USB charger (type A + C) | J2-BS-YKU2MR-⑧ | 1206 |
| | | 3 modules | 2× power socket 1× double USB charger (type A + A) | J2-BS-YKU3M-⑧ | 1156 |
| | | | 2× power socket 1× TUF double USB charger (type A + C) | J2-BS-YKU3MR-⑧ | 1244 |
| Cable outlet | None | | | • | |
| | Left | | BO-L | ◦ | |
| | Right | | BO-R | | |
| Glides | Plastic | | GD | • | |
| | Plastic nonskid | | GDN | 16 | |
| | Floor fixing glued | | GDG | 66 | |
| | Floor fixing screwed | | GDS | 46 | |
| | Floor fixing magnetic | | GDMG | 156 | |
| Wall spacer | None | | | • | |
| | Wall spacer (available only for GD and GDN glides) | | IN-WS | 108 | |
| Foam (only for upholstered shell) | Flame retardant foam | | FFR2 | • | |
| | Flame retardant foam with fireproof fabric | | FFRF | 189 | |
| Assembly | Assembled | | ASM-F | • | |
| | Unassembled | | ASM-U | ◦ | |
| Wood and wood-based materials | Raw material – EU timber regulation, from certified forests, FSC certificate – authorized companies | | FSCMIX | • | |

Sample order VTRAVEL BENCH PRM 3U TE1 (E-AA/SA CC-KG PRM-C-CC-KG TE-L-U0901TP GD ASM-F FSCMIX)

③ – Please specify metal colour code – see finishes

⑧ – Please specify media port standard: CH13, FR, GB, GE

• Available as standard (included in basic price)

◦ Available as an option (included in basic price)

V-Travel bench PRM 3U with internal table



VTRAVEL BENCH PRM 3U T11

W 2275 mm
D 660 mm
H 900mm
SH 465 mm
SH DIN 435 mm
WT 55,20 kg

Basic price (EUR)

2572

| Frame | | Beam | Legs | | | |
|--|--|------------------------------|------------------------------|-----------------|-----------------|-----|
| | Aluminium anodised | Aluminium polished | | E-(3)/(3) | • | |
| | | Aluminium powder-coated | | | 38 | |
| | | PU foam | | CC-(4) | • | |
| | | PU foam with cut-out in back | | CC-CT-(4) | ◦ | |
| Shell | Fully upholstered | Price group | 3 | BS-(5) | 138 | |
| | | | 4 | | 204 | |
| | | | 6 | | 620 | |
| | Fully upholstered with cut-out in back | Price group | 3 | BS-CT-(5) | 256 | |
| | | | 4 | | 320 | |
| | | | 6 | | 738 | |
| | | PU foam | | PRM-A-CC-(4) | • | |
| | | PU foam with cut-out in back | | PRM-A-CC-CT-(4) | ◦ | |
| PRM seat | Position A | Fully upholstered | Price group | 3 | PRM-A-BS-(5) | 69 |
| | | | | 4 | | 102 |
| | | | | 6 | | 310 |
| | Fully upholstered with cut-out in back | Price group | 3 | PRM-A-BS-CT-(5) | 128 | |
| | | | 4 | | 160 | |
| | | | 6 | | 369 | |
| | | | PU foam | | PRM-C-CC-(5) | • |
| | | | PU foam with cut-out in back | | PRM-C-CC-CT-(5) | ◦ |
| | Position C | Fully upholstered | Price group | 3 | PRM-C-BS-(5) | 69 |
| | | | | 4 | | 102 |
| 6 | | | | 310 | | |
| Fully upholstered with cut-out in back | Price group | 3 | PRM-C-BS-CT-(5) | 128 | | |
| | | 4 | | 160 | | |
| | | 6 | | 369 | | |

(3) – Please specify metal colour code – [see finishes](#)

(4) – Please specify plastic colour code – [see finishes](#)

(5) – Please specify upholstery colour code from selected price group – [see finishes](#)

- Available as standard (included in basic price)
- Available as an option (included in basic price)

PRICE GROUP 3: Silvertex
PRICE GROUP 4: Skai Parotega
PRICE GROUP 6: Arona leather

Price list

| | | | | | VTRAVEL BENCH PRM 3U T11 |
|-----------------------------------|---|---|---|----------------|--------------------------|
| PRM logo | None | | | | • |
| | Logo | | LOGO | | ◦ |
| Internal table | 1 piece | Between seats A/B | Laminate Traceless TP black | TE-L-U0901TP | • |
| | | Between seats B/C | | TE-R-U0901TP | ◦ |
| Internal armrest | None | | | | • |
| | 1 piece | | Aluminium polished | AI-J1-③ | 105 |
| | | | | | Aluminium powder-coated |
| | 3 pieces | | Aluminium polished | AI-J3-③ | 315 |
| | | | Aluminium powder-coated | | 363 |
| External armrests | None | | | | • |
| | 2 pieces | | Aluminium polished | AE-J2-③ | 174 |
| | | | Aluminium powder-coated | | 204 |
| Media between seats | One media port between seats | 2 modules | 1× power socket 1× double USB charger (type A + A) | J1-BS-YKU2M-⑧ | 838 |
| | | | 1× power socket 1× TUF double USB charger (type A + C) | J1-BS-YKU2MR-⑧ | 880 |
| | 3 modules | 2× power socket 1× double USB charger (type A + A) | J1-BS-YKU3M-⑧ | 855 | |
| | | 2× power socket 1× TUF double USB charger (type A + C) | J1-BS-YKU3MR-⑧ | 899 | |
| | One media port in table top | 2 modules | 1× power socket 1× double USB charger | J1-TT-YKU2M-⑧ | 798 |
| | | | 1× power socket 1× TUF double USB charger | J1-TT-YKU2MR-⑧ | 840 |
| Cable outlet | None | | | | • |
| | Left | | BO-L | | ◦ |
| | Right | | BO-R | | ◦ |
| Glides | Plastic | | GD | | • |
| | Plastic nonskid | | GDN | | 16 |
| | Floor fixing glued | | GDG | | 66 |
| | Floor fixing screwed | | GDS | | 46 |
| | Floor fixing magnetic | | GDMG | | 156 |
| Wall spacer | None | | | | • |
| | Wall spacer (available only for GD and GDN glides) | | IN-WS | | 108 |
| Foam (only for upholstered shell) | Flame retardant foam | | FFR2 | | • |
| | Flame retardant foam with fireproof fabric | | FFRF | | 189 |
| Assembly | Assembled | | ASM-F | | • |
| | Unassembled | | ASM-U | | ◦ |
| Wood and wood-based materials | Raw material – EU timber regulation, from certified forests, FSC certificate – authorized companies | | FSCMIX | | • |

Sample order VTRAVEL BENCH PRM 3U T11 (E-AA/SA CC-KG PRM-C-CC-KG TI-A-U0901TP GD ASM-F FSCMIX)

③ – Please specify metal colour code – see finishes

⑧ – Please specify media port standard: CH13, FR, GB, GE

• Available as standard (included in basic price)

◦ Available as an option (included in basic price)

V-Travel bench PRM 4U



VTRAVEL BENCH PRM 4U

W 2475 mm
D 660 mm
H 900 mm
SH 465 mm
SH DIN 435 mm
WT 63,60 kg

Basic price (EUR)

2875

| Frame | | Beam | Legs | | |
|------------|--|------------------------------|------|-----------------|------|
| | Aluminium anodised | Aluminium polished | | E-(3)/(3) | • |
| | | Aluminium powder-coated | | | 38 |
| Shell | | PU foam | | CC-(4) | • |
| | | PU foam with cut-out in back | | CC-CT-(4) | ◦ |
| | Fully upholstered | Price group | 3 | BS-(5) | 207 |
| | | | 4 | | 306 |
| | | | 6 | | 930 |
| | Fully upholstered with cut-out in back | Price group | 3 | BS-CT-(5) | 384 |
| | | | 4 | | 480 |
| | | | 6 | | 1107 |
| PRM seat | | PU foam | | PRM-A-CC-(4) | • |
| | | PU foam with cut-out in back | | PRM-A-CC-CT-(4) | ◦ |
| Position A | Fully upholstered | Price group | 3 | PRM-A-BS-(5) | 69 |
| | | | 4 | | 102 |
| | | | 6 | | 310 |
| | Fully upholstered with cut-out in back | Price group | 3 | PRM-A-BS-CT-(5) | 128 |
| | | | 4 | | 160 |
| | | | 6 | | 369 |
| PRM seat | | PU foam | | PRM-D-CC-(5) | • |
| | | PU foam with cut-out in back | | PRM-D-CC-CT-(5) | ◦ |
| Position D | Fully upholstered | Price group | 3 | PRM-D-BS-(5) | 69 |
| | | | 4 | | 102 |
| | | | 6 | | 310 |
| | Fully upholstered with cut-out in back | Price group | 3 | PRM-D-BS-CT-(5) | 128 |
| | | | 4 | | 160 |
| | | | 6 | | 369 |

③ – Please specify metal colour code – [see finishes](#)

④ – Please specify plastic colour code – [see finishes](#)

⑤ – Please specify upholstery colour code from selected price group – [see finishes](#)

• Available as standard (included in basic price)

◦ Available as an option (included in basic price)

PRICE GROUP 3: Silvertex
PRICE GROUP 4: Skai Parotega
PRICE GROUP 6: Arona leather

Price list

| | | | | VTRAVEL BENCH PRM 4U |
|---|---|---|--------------------|----------------------|
| PRM logo | None | | | • |
| | Logo | | LOGO | ◦ |
| Internal armrest | None | | | • |
| | 1 piece | Aluminium polished | AI-J1-③ | 105 |
| | | Aluminium powder-coated | | 121 |
| | 3 pieces | Aluminium polished | AI-J3-③ | 315 |
| Aluminium powder-coated | | | 363 | |
| External armrests | None | | | • |
| | 2 pieces | Aluminium polished | AE-J2-③ | 174 |
| | | Aluminium powder-coated | | 204 |
| Media between seats | None | | | • |
| | 2 modules | 1 × power socket 1 × double USB charger (type A + A) | J2-BS- YKU2M-⑧ | 1196 |
| | | 1 × power socket 1 × TUF double USB charger (type A + C) | J2-BS- YKU2MR-⑧ | 1280 |
| | 3 modules | 2 × power socket 1 × double USB charger (type A + A) | J2-BS- YKU3M-⑧ | 1230 |
| | | 2 × power socket 1 × TUF double USB charger (type A + C) | J2-BS- YKU3MR-⑧ | 1318 |
| Cable outlet | None | | | • |
| | Left | | BO-L | ◦ |
| | Right | | BO-R | |
| Glides | Plastic | | GD | • |
| | Plastic nonskid | | GDN | 16 |
| | Floor fixing glued | | GDG | 66 |
| | Floor fixing screwed | | GDS | 46 |
| | Floor fixing magnetic | | GDMG | 156 |
| Wall spacer | None | | | • |
| | Wall spacer (available only for GD and GDN glides) | | IN-WS | 108 |
| Foam (only for upholstered shell) | Flame retardant foam | | FFR2 | • |
| | Flame retardant foam with fireproof fabric | | FFRF | 252 |
| Assembly | Assembled | | ASM-F | • |
| | Unassembled | | ASM-U | ◦ |
| Wood and wood-based materials (only for upholstered shell) | Raw material from certified forests, FSC certificate – authorized companies | | FSC | • |
| Sample order | VTRAVEL BENCH PRM 4U (E-AA/SA CC-KG PRM-D-CC-KG GD ASM-F FSC) | | | |

③ – Please specify metal colour code – see finishes

⑧ – Please specify media port standard: CH13, FR, GB, GE

• Available as standard (included in basic price)

◦ Available as an option (included in basic price)

V-Travel bench PRM 4U with external table



VTRAVEL BENCH PRM 4U TE1

W 2790 mm
D 660 mm
H 900 mm
SH 465 mm
SH DIN 435 mm
WT 68,40 kg

Basic price (EUR)

3135

| Frame | | Beam | Legs | | | |
|--|--|------------------------------|------------------------------|-----------------|-----------------|-----|
| | Aluminium anodised | Aluminium polished | | E-(3)/(3) | • | |
| | | Aluminium powder-coated | | | 38 | |
| | | PU foam | | CC-(4) | • | |
| | | PU foam with cut-out in back | | CC-CT-(4) | ◦ | |
| Shell | Fully upholstered | Price group | 3 | BS-(5) | 207 | |
| | | | 4 | | 306 | |
| | | | 6 | | 930 | |
| | Fully upholstered with cut-out in back | Price group | 3 | BS-CT-(5) | 384 | |
| | | | 4 | | 480 | |
| | | | 6 | | 1107 | |
| | | PU foam | | PRM-A-CC-(4) | • | |
| | | PU foam with cut-out in back | | PRM-A-CC-CT-(4) | ◦ | |
| PRM seat | Position A | Fully upholstered | Price group | 3 | PRM-A-BS-(5) | 69 |
| | | | | 4 | | 102 |
| | | | | 6 | | 310 |
| | Fully upholstered with cut-out in back | Price group | 3 | PRM-A-BS-CT-(5) | 128 | |
| | | | 4 | | 160 | |
| | | | 6 | | 369 | |
| | | | PU foam | | PRM-D-CC-(5) | • |
| | | | PU foam with cut-out in back | | PRM-D-CC-CT-(5) | ◦ |
| | Position D | Fully upholstered | Price group | 3 | PRM-D-BS-(5) | 69 |
| | | | | 4 | | 102 |
| 6 | | | | 310 | | |
| Fully upholstered with cut-out in back | Price group | 3 | PRM-D-BS-CT-(5) | 128 | | |
| | | 4 | | 160 | | |
| | | 6 | | 369 | | |

③ – Please specify metal colour code – [see finishes](#)

④ – Please specify plastic colour code – [see finishes](#)

⑤ – Please specify upholstery colour code from selected price group – [see finishes](#)

• Available as standard (included in basic price)

◦ Available as an option (included in basic price)

PRICE GROUP 3: Silvertex
PRICE GROUP 4: Skai Parotega
PRICE GROUP 6: Arona leather

Price list

| | | | | | VTRAVEL BENCH PRM 4U TE1 |
|--|---|-------------------------|---|----------------|--------------------------|
| PRM logo | None | | | | • |
| | Logo | | LOGO | | ◦ |
| External table | 1 piece | Left | Laminate Traceless TP black | TE-L-U0901TP | • |
| | | Right | | TE-R-U0901TP | ◦ |
| Internal armrest | None | | | | • |
| | 1 piece | | Aluminium polished | AI-J1-③ | 105 |
| | | | Aluminium powder-coated | | 121 |
| | 3 pieces | | Aluminium polished | AI-J3-③ | 315 |
| | | Aluminium powder-coated | 363 | | |
| External armrests | None | | | | • |
| | 2 pieces | | Aluminium polished | AE-J2-③ | 174 |
| | | Aluminium powder-coated | 204 | | |
| Media between seats | Two media ports between seats | 2 modules | 1× power socket 1× double USB charger (type A + A) | J2-BS-YKU2M-⑧ | 1196 |
| | | | 1× power socket 1× TUF double USB charger (type A + C) | J2-BS-YKU2MR-⑧ | 1280 |
| | | 3 modules | 2× power socket 1× double USB charger (type A + A) | J2-BS-YKU3M-⑧ | 1230 |
| | | | 2× power socket 1× TUF double USB charger (type A + C) | J2-BS-YKU3MR-⑧ | 1318 |
| Cable outlet | None | | | | • |
| | Left | | BO-L | | ◦ |
| | Right | | BO-R | | ◦ |
| Glides | Plastic | | GD | | • |
| | Plastic nonskid | | GDN | | 16 |
| | Floor fixing glued | | GDG | | 66 |
| | Floor fixing screwed | | GDS | | 46 |
| | Floor fixing magnetic | | GDMG | | 156 |
| Wall spacer | None | | | | • |
| | Wall spacer (available only for GD and GDN glides) | | IN-WS | | 108 |
| Foam (only for upholstered shell) | Flame retardant foam | | FFR2 | | • |
| | Flame retardant foam with fireproof fabric | | FFRF | | 252 |
| Assembly | Assembled | | ASM-F | | • |
| | Unassembled | | ASM-U | | ◦ |
| Wood and wood-based materials | Raw material – EU timber regulation, from certified forests, FSC certificate – authorized companies | | FSCMIX | | • |

Sample order VTRAVEL BENCH PRM 4U TE1 (E-AA/SA CC-KG PRM-D-CC-KG TE-L-U0901TP GD ASM-F FSCMIX)

③ – Please specify metal colour code – see finishes

⑧ – Please specify media port standard: CH13, FR, GB, GE

• Available as standard (included in basic price)

◦ Available as an option (included in basic price)

V-Travel bench PRM 4U with internal table



VTRAVEL BENCH PRM 4U T11

W 2875 mm
D 660 mm
H 900 mm
SH 465 mm
SH DIN 435 mm
WT 69,70kg

Basic price (EUR)

3172

| Frame | | Beam | Legs | | | |
|----------|--|--|------------------------------|-----------------|-----------------|-----|
| | Aluminium anodised | Aluminium polished | | E-(3)/(3) | • | |
| | | Aluminium powder-coated | | | 38 | |
| | | PU foam | | CC-(4) | • | |
| | | PU foam with cut-out in back | | CC-CT-(4) | ◦ | |
| Shell | Fully upholstered | Price group | 3 | BS-(5) | 207 | |
| | | | 4 | | 306 | |
| | | | 6 | | 930 | |
| | Fully upholstered with cut-out in back | Price group | 3 | BS-CT-(5) | 384 | |
| | | | 4 | | 480 | |
| | | | 6 | | 1107 | |
| | | PU foam | | PRM-A-CC-(4) | • | |
| | | PU foam with cut-out in back | | PRM-A-CC-CT-(4) | ◦ | |
| PRM seat | Position A | Fully upholstered | Price group | 3 | PRM-A-BS-(5) | 69 |
| | | | | 4 | | 102 |
| | | | | 6 | | 310 |
| | | Fully upholstered with cut-out in back | Price group | 3 | PRM-A-BS-CT-(5) | 128 |
| | | | | 4 | | 160 |
| | | | | 6 | | 369 |
| | | | PU foam | | PRM-D-CC-(5) | • |
| | | | PU foam with cut-out in back | | PRM-D-CC-CT-(5) | ◦ |
| | Position D | Fully upholstered | Price group | 3 | PRM-D-BS-(5) | 69 |
| | | | | 4 | | 102 |
| | | | | 6 | | 310 |
| | | Fully upholstered with cut-out in back | Price group | 3 | PRM-D-BS-CT-(5) | 128 |
| 4 | | | | 160 | | |
| 6 | | | | 369 | | |

③ – Please specify metal colour code – [see finishes](#)

④ – Please specify plastic colour code – [see finishes](#)

⑤ – Please specify upholstery colour code from selected price group – [see finishes](#)

• Available as standard (included in basic price)

◦ Available as an option (included in basic price)

PRICE GROUP 3: Silvertex
PRICE GROUP 4: Skai Parotega
PRICE GROUP 6: Arona leather

Price list

| | | | | | VTRAVEL BENCH PRM 4U TI1 |
|-------------------------------|---|---|---|----------------|--------------------------|
| PRM logo | None | | | | • |
| | Logo | | LOGO | | ◦ |
| Internal table | 1 piece | Between seats A/B | Laminate | TE-L-U0901TP | • |
| | | Between seats C/D | Traceless TP black | TE-R-U0901TP | ◦ |
| Internal armrest | None | | | | • |
| | 1 piece | Aluminium polished | | AI-J1-③ | 105 |
| | | Aluminium powder-coated | | | 121 |
| | 4 pieces | Aluminium polished | | AI-J4-③ | 420 |
| Aluminium powder-coated | | 484 | | | |
| External armrests | None | | | | • |
| | 2 pieces | Aluminium polished | | AE-J2-③ | 174 |
| Aluminium powder-coated | | 204 | | | |
| Media between seats | None | | | | • |
| | Two media ports between seats | 2 modules | 1 × power socket 1 × double USB charger (type A + A) | J2-BS-YKU2M-⑧ | 1317 |
| | | | 1 × power socket 1 × TUF double USB charger (type A + C) | J2-BS-YKU2MR-⑧ | 1401 |
| | 3 modules | 2 × power socket 1 × double USB charger (type A + A) | J2-BS-YKU3M-⑧ | 1351 | |
| | | | 2 × power socket 1 × TUF double USB charger (type A + C) | J2-BS-YKU3MR-⑧ | 1439 |
| Media in table top | One media port in table top | 2 modules | 1 × power socket 1 × double USB charger | J1-TT-YKU2M-⑧ | 820 |
| | | | 1 × power socket 1 × TUF double USB charger | J1-TT-YKU2MR-⑧ | 862 |
| Cable outlet | None | | | | • |
| | Left | | BO-L | | ◦ |
| | Right | | BO-R | | |
| Glides | Plastic | | GD | | • |
| | Plastic nonskid | | GDN | | 16 |
| | Floor fixing glued | | GDG | | 66 |
| | Floor fixing screwed | | GDS | | 46 |
| | Floor fixing magnetic | | GDMG | | 156 |
| Wall spacer | None | | | | • |
| | Wall spacer (available only for GD and GDN glides) | | IN-WS | | 108 |
| Foam (for upholstered shell) | Flame retardant foam | | FFR2 | | • |
| | Flame retardant foam with fireproof fabric | | FFRF | | 252 |
| Assembly | Assembled | | ASM-F | | • |
| | Unassembled | | ASM-U | | ◦ |
| Wood and wood-based materials | Raw material – EU timber regulation, from certified forests, FSC certificate – authorized companies | | FSCMIX | | • |
| Sample order | VTRAVEL BENCH PRM 4U TI1 (E-AA/POL CC-KG PRM-D-CC-KG TI-A-U0901TP GD ASM-F FSCMIX) | | | | |

③ – Please specify metal colour code – see finishes

⑧ – Please specify media port standard: CH13, FR, GB, GE

• Available as standard (included in basic price)

◦ Available as an option (included in basic price)

V-Travel bench PRM 5U



VTRAVEL BENCH PRM 5U

W 3075 mm
D 660 mm
H 900 mm
SH 465 mm
SH DIN 435 mm
WT 79,90 kg

Basic price (EUR)

3614

| Frame | | Beam | Legs | | | |
|--|--|------------------------------|------------------------------|-----------------|-----------------|-----|
| | Aluminium anodised | Aluminium polished | | E-(3)/(3) | • | |
| | | Aluminium powder-coated | | | 57 | |
| | | PU foam | | CC-(4) | • | |
| | | PU foam with cut-out in back | | CC-CT-(4) | ◦ | |
| Shell | Fully upholstered | Price group | 3 | BS-(5) | 276 | |
| | | | 4 | | 408 | |
| | | | 6 | | 1240 | |
| | Fully upholstered with cut-out in back | Price group | 3 | BS-CT-(5) | 512 | |
| | | | 4 | | 640 | |
| | | | 6 | | 1476 | |
| | | PU foam | | PRM-A-CC-(4) | • | |
| | | PU foam with cut-out in back | | PRM-A-CC-CT-(4) | ◦ | |
| PRM seat | Position A | Fully upholstered | Price group | 3 | PRM-A-BS-(5) | 69 |
| | | | | 4 | | 102 |
| | | | | 6 | | 310 |
| | Fully upholstered with cut-out in back | Price group | 3 | PRM-A-BS-CT-(5) | 128 | |
| | | | 4 | | 160 | |
| | | | 6 | | 369 | |
| | | | PU foam | | PRM-E-CC-(5) | • |
| | | | PU foam with cut-out in back | | PRM-E-CC-CT-(5) | ◦ |
| | Position E | Fully upholstered | Price group | 3 | PRM-E-BS-(5) | 69 |
| | | | | 4 | | 102 |
| 6 | | | | 310 | | |
| Fully upholstered with cut-out in back | Price group | 3 | PRM-E-BS-CT-(5) | 128 | | |
| | | 4 | | 160 | | |
| | | 6 | | 369 | | |

③ – Please specify metal colour code – [see finishes](#)

④ – Please specify plastic colour code – [see finishes](#)

⑤ – Please specify upholstery colour code from selected price group – [see finishes](#)

• Available as standard (included in basic price)

◦ Available as an option (included in basic price)

PRICE GROUP 3: Silvertex
PRICE GROUP 4: Skai Parotega
PRICE GROUP 6: Arona leather

Price list

| | | | | VTRAVEL BENCH PRM 5U |
|--|---|---|--------------------|----------------------|
| PRM logo | None | | | • |
| | Logo | LOGO | | ◦ |
| Internal armrests | None | | | • |
| | 1 piece | Aluminium polished | AI-J1-③ | 105 |
| | | Aluminium powder-coated | | 121 |
| | 4 pieces | Aluminium polished | AI-J4-③ | 420 |
| Aluminium powder-coated | | | 484 | |
| External armrests | None | | | • |
| | 2 pieces | Aluminium polished | AE-J2-③ | 174 |
| | | Aluminium powder-coated | | 204 |
| Media between seats | None | | | • |
| | 2 modules | 1 × power socket 1 × double USB charger (type A + A) | J2-BS- YKU2M-⑧ | 1327 |
| | | 1 × power socket 1 × TUF double USB charger (type A + C) | J2-BS- YKU2MR-⑧ | 1411 |
| | 3 modules | 2 × power socket 1 × double USB charger (type A + A) | J2-BS- YKU3M-⑧ | 1361 |
| | | 2 × power socket 1 × TUF double USB charger (type A + C) | J2-BS- YKU3MR-⑧ | 1449 |
| Cable outlet | None | | | • |
| | Left | BO-L | | ◦ |
| | Right | BO-R | | |
| Glides | Plastic | | GD | • |
| | Plastic nonskid | | GDN | 24 |
| | Floor fixing glued | | GDG | 66 |
| | Floor fixing screwed | | GDS | 46 |
| | Floor fixing magnetic | | GDMG | 234 |
| Wall spacer | None | | | • |
| | Wall spacer (available only for GD and GDN glides) | | IN-WS | 108 |
| Foam (for upholstered shell) | Flame retardant foam | | FFR2 | • |
| | Flame retardant foam with fireproof fabric | | FFRF | 315 |
| Assembly | Assembled | | ASM-F | • |
| | Unassembled | | ASM-U | ◦ |
| Wood and wood-based materials (only for upholstered shell) | Raw material from certified forests, FSC certificate – authorized companies | | FSC | • |
| Sample order | VTRAVEL BENCH PRM 5U (E-AA/SA CC-KG PRM-D-CC-KG GD ASM-F FSC) | | | |

③ – Please specify metal colour code – [see finishes](#)

⑧ – Please specify media port standard: CH13, FR, GB, GE

• Available as standard (included in basic price)

◦ Available as an option (included in basic price)

V-Travel bench PRM 5U with external table



VTRAVEL BENCH PRM 5U TE1

W 3390 mm
D 660 mm
H 900 mm
SH 465 mm
SH DIN 435 mm
WT 84,60 kg

Basic price (EUR)

3874

| Frame | Beam | Legs | | | | |
|--|--|-------------------------|-----------------|-----------------|--------------|-----|
| | Aluminium anodised | Aluminium polished | | E-(3)/(3) | • | |
| | | Aluminium powder-coated | | | 57 | |
| Shell | PU foam | | | CC-(4) | • | |
| | PU foam with cut-out in back | | | CC-CT-(4) | ◦ | |
| | Fully upholstered | Price group | 3 | BS-(5) | 276 | |
| | | | 4 | | 408 | |
| | | | 6 | | 1240 | |
| | Fully upholstered with cut-out in back | Price group | 3 | BS-CT-(5) | 512 | |
| 4 | | | 640 | | | |
| 6 | | | 1476 | | | |
| PRM seat | PU foam | | | PRM-A-CC-(4) | • | |
| | PU foam with cut-out in back | | | PRM-A-CC-CT-(4) | ◦ | |
| | Position A | Fully upholstered | Price group | 3 | PRM-A-BS-(5) | 69 |
| | | | | 4 | | 102 |
| | | | | 6 | | 310 |
| | Fully upholstered with cut-out in back | Price group | 3 | PRM-A-BS-CT-(5) | 128 | |
| | | | 4 | | 160 | |
| | | | 6 | | 369 | |
| | PU foam | | | PRM-E-CC-(5) | • | |
| | PU foam with cut-out in back | | | PRM-E-CC-CT-(5) | ◦ | |
| | Position E | Fully upholstered | Price group | 3 | PRM-E-BS-(5) | 69 |
| | | | | 4 | | 102 |
| 6 | | | | 310 | | |
| Fully upholstered with cut-out in back | Price group | 3 | PRM-E-BS-CT-(5) | 128 | | |
| | | 4 | | 160 | | |
| | | 6 | | 369 | | |

③ - Please specify metal colour code – [see finishes](#)

④ - Please specify plastic colour code – [see finishes](#)

⑤ - Please specify upholstery colour code from selected price group – [see finishes](#)

• Available as standard (included in basic price)

◦ Available as an option (included in basic price)

PRICE GROUP 3: Silvertex
PRICE GROUP 4: Skai Parotega
PRICE GROUP 6: Arona leather

Price list

| | | | | | VTRAVEL BENCH PRM 5U TE1 |
|-------------------------------|---|-------------------------|---|--------------------|--------------------------|
| PRM logo | None | | | | • |
| | Logo | | LOGO | | ◦ |
| External table | 1 piece | Left | Laminate Traceless TP black | TE-L-U0901TP | • |
| | | Right | | TE-R-U0901TP | ◦ |
| Internal armrest | None | | | | • |
| | 1 piece | Aluminium polished | | AI-J1-③ | 105 |
| | | Aluminium powder-coated | | | 121 |
| | 4 pieces | Aluminium polished | | AI-J4-③ | 420 |
| Aluminium powder-coated | | 484 | | | |
| External armrests | None | | | | • |
| | 2 pieces | Aluminium polished | | AE-J2-③ | 174 |
| | | Aluminium powder-coated | | | 204 |
| Media between seats | None | | | | • |
| | Two media ports between seats | 2 modules | 1× power socket 1× double USB charger (type A + A) | J2-BS- YKU2M-⑧ | 1327 |
| | | | 1× power socket 1× TUF double USB charger (type A + C) | J2-BS- YKU2MR-⑧ | 1411 |
| | | 3 modules | 2× power socket 1× double USB charger (type A + A) | J2-BS- YKU3M-⑧ | 1361 |
| | | | 2× power socket 1× TUF double USB charger (type A + C) | J2-BS- YKU3MR-⑧ | 1449 |
| | Cable outlet | None | | | |
| Left | | | BO-L | ◦ | |
| Right | | | BO-R | | |
| Glides | Plastic | | GD | • | |
| | Plastic nonskid | | GDN | 24 | |
| | Floor fixing glued | | GDG | 66 | |
| | Floor fixing screwed | | GDS | 46 | |
| | Floor fixing magnetic | | GDMG | 234 | |
| Wall spacer | None | | | | • |
| | Wall spacer (available only for GD and GDN glides) | | IN-WS | 108 | |
| Foam (for upholstered shell) | Flame retardant foam | | FFR2 | • | |
| | Flame retardant foam with fireproof fabric | | FFRF | 315 | |
| Assembly | Assembled | | ASM-F | • | |
| | Unassembled | | ASM-U | ◦ | |
| Wood and wood-based materials | Raw material – EU timber regulation, from certified forests, FSC certificate – authorized companies | | FSCMIX | • | |
| Sample order | VTRAVEL BENCH PRM 5U TE1 (E-AA/SA CC-KG PRM-D-CC-KG TE-L-U0901TP GD ASM-F FSCMIX) | | | | |

③ – Please specify metal colour code – [see finishes](#)

⑧ – Please specify media port standard: CH13, FR, GB, GE

- Available as standard (included in basic price)
- Available as an option (included in basic price)

V-Travel bench PRM 5U with internal table



VTRAVEL BENCH PRM 5U T11

W 3475 mm
D 660 mm
H 900 mm
SH 465 mm
SH DIN 435 mm
WT 86,0 kg

Basic price (EUR)

3911

| Frame | | Beam | Legs | | | |
|----------|--|--|------------------------------|-----------------|-----------------|-----|
| | Aluminium anodised | Aluminium polished | | E-(3)/(3) | • | |
| | | Aluminium powder-coated | | | 57 | |
| | | PU foam | | CC-(4) | • | |
| | | PU foam with cut-out in back | | CC-CT-(4) | ◦ | |
| Shell | Fully upholstered | Price group | 3 | BS-(5) | 276 | |
| | | | 4 | | 408 | |
| | | | 6 | | 1240 | |
| | Fully upholstered with cut-out in back | Price group | 3 | BS-CT-(5) | 512 | |
| | | | 4 | | 640 | |
| | | | 6 | | 1476 | |
| | | PU foam | | PRM-A-CC-(4) | • | |
| | | PU foam with cut-out in back | | PRM-A-CC-CT-(4) | ◦ | |
| PRM seat | Position A | Fully upholstered | Price group | 3 | PRM-A-BS-(5) | 69 |
| | | | | 4 | | 102 |
| | | | | 6 | | 310 |
| | | Fully upholstered with cut-out in back | Price group | 3 | PRM-A-BS-CT-(5) | 128 |
| | | | | 4 | | 160 |
| | | | | 6 | | 369 |
| | | | PU foam | | PRM-E-CC-(5) | • |
| | | | PU foam with cut-out in back | | PRM-E-CC-CT-(5) | ◦ |
| | Position E | Fully upholstered | Price group | 3 | PRM-E-BS-(5) | 69 |
| | | | | 4 | | 102 |
| | | | | 6 | | 310 |
| | | Fully upholstered with cut-out in back | Price group | 3 | PRM-E-BS-CT-(5) | 128 |
| 4 | | | | 160 | | |
| 6 | | | | 369 | | |

③ – Please specify metal colour code – [see finishes](#)

④ – Please specify plastic colour code – [see finishes](#)

⑤ – Please specify upholstery colour code from selected price group – [see finishes](#)

• Available as standard (included in basic price)

◦ Available as an option (included in basic price)

PRICE GROUP 3: Silvertex
PRICE GROUP 4: Skai Parotega
PRICE GROUP 6: Arona leather

Price list

| | | | | | VTRAVEL BENCH PRM 5U TI1 |
|--|---|---|---|----------------|--------------------------|
| PRM logo | None | | | | • |
| | Logo | | LOGO | | ◦ |
| Internal table | 1 piece | Between seats A/B | Laminate | TE-L-U0901TP | • |
| | | Between seats D/E | Traceless TP black | TE-R-U0901TP | ◦ |
| Internal armrest | None | | | | • |
| | 1 piece | Aluminium polished | | AI-J1-③ | 105 |
| | | Aluminium powder-coated | | | 121 |
| | 5 pieces | Aluminium polished | | AI-J5-③ | 525 |
| Aluminium powder-coated | | 605 | | | |
| External armrests | None | | | | • |
| | 2 pieces | Aluminium polished | | AE-J2-③ | 174 |
| Aluminium powder-coated | | 204 | | | |
| Media between seats | None | | | | • |
| | Two media ports between seats | 2 modules | 1 × power socket 1 × double USB charger (type A + A) | J2-BS-YKU2M-⑧ | 1391 |
| | | | 1 × power socket 1 × TUF double USB charger (type A + C) | J2-BS-YKU2MR-⑧ | 1475 |
| | 3 modules | 2 × power socket 1 × double USB charger (type A + A) | | J2-BS-YKU3M-⑧ | 1425 |
| | | | 2 × power socket 1 × TUF double USB charger (type A + C) | J2-BS-YKU3MR-⑧ | 1513 |
| | One media port in table top | 2 modules | 1 × power socket 1 × double USB charger | J1-TT-YKU2M-⑧ | 951 |
| 1 × power socket 1 × TUF double USB charger | | | J1-TT-YKU2MR-⑧ | 993 | |
| Cable outlet | None | | | | • |
| | Left | | BO-L | | ◦ |
| | Right | | BO-R | | |
| Glides | Plastic | | GD | | • |
| | Plastic nonskid | | GDN | | 24 |
| | Floor fixing glued | | GDG | | 66 |
| | Floor fixing screwed | | GDS | | 46 |
| | Floor fixing magnetic | | GDMG | | 234 |
| Wall spacer | None | | | | • |
| | Wall spacer (available only for GD and GDN glides) | | IN-WS | | 108 |
| Foam (for upholstered shell) | Flame retardant foam | | FFR2 | | • |
| | Flame retardant foam with fireproof fabric | | FFRF | | 315 |
| Assembly | Assembled | | ASM-F | | • |
| | Unassembled | | ASM-U | | ◦ |
| Wood and wood-based materials | Raw material – EU timber regulation, from certified forests, FSC certificate – authorized companies | | FSCMIX | | • |
| Sample order | VTRAVEL BENCH PRM 5U TI1 (E-AA/POL CC-KG PRM-E-CC-KG TI-A-U0901TP GD ASM-F FSCMIX) | | | | |

③ – Please specify metal colour code – [see finishes](#)

⑧ – Please specify media port standard: CH13, FR, GB, GE

• Available as standard (included in basic price)

◦ Available as an option (included in basic price)

Finishes

Metal



Polished Aluminium
POL



RAL 9005
Jet Black
BL



RAL 9006
White Aluminium
WK



Silver Aluminium
SA

Belka



Black Matt Anode
AC



Natural Anode
AA

Laminate



U0901TP
Traceless
Black

Polyurethane

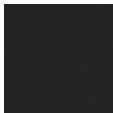

KG
Black Grey



KX
Grey Brown



KQ
Quartz Grey



KZ
Grey Blue

General notes

All specified dimensions are approximate. Subject to minor modifications or differences for reasons of design improvements or for technical reasons.

- W = width
- D = depth
- H = height
- DI = diameter
- SH = seat height
- SH DIN = seat height measured acc. to DIN EN 1335-1

In compliance with the highest quality standards "Quality is irreplaceable." Guided by this principle, each product line is subjected to stringent quality testing.

Only the products marked in this document are FSC® (FSC®-C120977) certified. Look for our FSC®-certified products. Sale of products that meet the FSC® requirements is possible only by Nowy Styl Sp. z o.o., Nowy Styl Nederland B.V. and Kusch + Co GmbH.



The mark of responsible forestry

The FSC® certificate applies to responsible forest management and the entire flow of raw materials from the forest to the customer. Each stage of the chain is monitored in terms of social, ecological and economic performance. The product with the FSC® label gives customers a guarantee that the wood used for the production of the product comes from sources managed in a sustainable manner.

Warranty

Manufacturer declares that the products shall be free from defects in material or workmanship. The warranty is given to the original purchaser only, for normal commercial usage. Detailed terms of warranty and warranty periods are available at <https://www.kusch.com/en/warranty>

ona plaza price list 2026

Ona plaza

Design by Jorge Pensi

Chair on 4 metal legs



**ONA PLAZA FRAME
CHAIR 4LA UPH**



**ONA PLAZA FRAME
CHAIR 4LA HB UPH**

Cantilever chair



**ONA PLAZA FRAME
CHAIR CFA UPH**



**ONA PLAZA FRAME
CHAIR CFA HB UPH**

Price list

Ona Plaza chair on 4 metal legs

Upholstered shell.

Frame: 4 legs with armrests made of powder-coated or chromium plated steel, stackable, plastic glides.



| ONA PLAZA FRAME CHAIR 4LA UPH | ONA PLAZA FRAME CHAIR 4LA HB UPH |
|---|--|
| W 580 mm D 580 mm H 860 mm SH 450 mm SH DIN 435 mm WT 9.5 kg | W 580 mm D 610 mm H 970 mm SH 450 mm SH DIN 435 mm WT 10 kg |

Basic price (EUR)
according to upholstery price group

| | | | | |
|--------------------------------------|---|-----------------|-----|-----|
| | Price group 2 | | 572 | 642 |
| | Price group 3 | | 592 | 663 |
| | Price group 4 | | 617 | 691 |
| | Price group 5 | | 636 | 712 |
| | Price group 6 | | 840 | 956 |
| Frame | Steel | powder-coated | • | • |
| | | chromium plated | 51 | 51 |
| Shell | Upholstered | BS-⑤ | • | • |
| Backrest | Standard backrest | | • | • |
| | Rib pattern | BA-RP | 15 | 15 |
| Armpads | None | | • | • |
| | Black plastic armpads | AP-KG | 56 | 56 |
| Glides | Plastic | GD | • | • |
| | Plastic with felt | GDF | 8 | 8 |
| Foam | Standard foam | FSTD | • | • |
| | Flame retardant foam | FFR2 | 11 | 11 |
| | Flame retardant foam with fireproof fabric | FFRF | 201 | 264 |
| Wood and wood-based materials | Raw material from certified forests, FSC certificate – authorized companies | FSC | • | • |
| Sample order | ONA PLAZA FRAME CHAIR 4LA UPH (E-WK BS-CPC10 AP-KG GD FSTD FSC) | | | |

③ – Please specify metal colour code – [see finishes](#)

⑤ – Please specify upholstery colour code from selected price group – [see finishes](#)

• Available as standard (included in basic price)

PRICE GROUP 2: Cura, Cura Loop, Valencia, Xtreme
 PRICE GROUP 3: Silvertex, Step/Step Melange
 PRICE GROUP 4: Blazer, Main Line Flax, Oceanic, skai Parotega, Synergy
 PRICE GROUP 5: Remix 3
 PRICE GROUP 6: Nappa leather

Price list

Ona Plaza cantilever chair

Upholstered shell, always ribbed pattern on backrest when upholstered with leather
Cantilever frame with armrests made of powder coated or chromium plated steel, stackable.
Two backrest heights available.



**ONA PLAZA FRAME CHAIR
CFA UPH**

W 560 mm
D 590 mm
H 860 mm
SH 450 mm
SH DIN 425 mm
WT 9,5 kg

**ONA PLAZA FRAME CHAIR
CFA HB UPH**

W 560 mm
D 610 mm
H 970 mm
SH 450 mm
SH DIN 425 mm
WT 10 kg

Basic price (EUR)
according to upholstery price group

| | | | | |
|--------------------------------------|---|-------------------|-----|-----|
| | Price group 2 | | 579 | 648 |
| | Price group 3 | | 598 | 669 |
| | Price group 4 | | 624 | 698 |
| | Price group 5 | | 643 | 718 |
| | Price group 6 | | 837 | 953 |
| Frame | Steel | powder-coated | • | • |
| | | chromium plated | 79 | 79 |
| Shell | Upholstered | | • | • |
| Backrest | Standard backrest | Price groups 2-5 | • | • |
| | Ribbed pattern | Price groups 6, 7 | 15 | 15 |
| | | | o | o |
| Armpads | None | | • | • |
| | Black plastic armpads | AP-KG | 56 | 56 |
| Glides | No glides, nose to avoid tipping | | • | • |
| | Plastic | GD | 8 | 8 |
| | Plastic with felt | GDF | 16 | 16 |
| | Protect glides | GDT | 37 | 37 |
| | Standard foam | FSTD | • | • |
| Foam | Flame retardant foam | FFR2 | 11 | 11 |
| | Flame retardant foam with fireproof fabric | FFRF | 201 | 264 |
| Wood and wood-based materials | Raw material from certified forests, FSC certificate – authorized companies | FSC | • | • |

Sample order ONA PLAZA FRAME CHAIR CFA UPH (E-WK BS-CPC10 AP-KG FSTD FSC)

③ – Please specify metal colour code – [see finishes](#)

⑤ – Please specify upholstery colour code from selected price group – [see finishes](#)

- Available as standard (included in basic price)
- o Available as an option (included in basic price)

PRICE GROUP 2: Cura, Cura Loop, Valencia, Xtreme
PRICE GROUP 3: Silvertex, Step/Step Melange
PRICE GROUP 4: Blazer, Main Line Flax, Oceanic, skai Parotega, Synergy
PRICE GROUP 5: Remix 3
PRICE GROUP 6: Nappa leather

Finishes

Metal



NCS S
2005-Y60R
Cashmere
NK



RAL 1024
Ochre Yellow
OY



RAL 030
50 40
Vermillion
Red
VR



RAL 6003
Olive Green
OG



RAL 5000
Violet Blue
VB



Chrome
CR



RAL 9005
Jet Black
BK



RAL 9006
White
Aluminium
WK

General notes

All specified dimensions are approximate. Subject to minor modifications or differences for reasons of design improvements or for technical reasons.

- W = width
- D = depth
- H = height
- DI = diameter
- SH = seat height
- SH DIN = seat height measured acc. to DIN EN 1335-1

In compliance with the highest quality standards "Quality is irreplaceable." Guided by this principle, each product line is subjected to stringent quality testing.

Only the products marked in this document are FSC® (FSC®-C120977). Look for our FSC®-certified products. Sale of products that meet the FSC® requirements is possible only by Nowy Styl Sp. z o.o., Nowy Styl Nederland B.V. and Kusch + Co GmbH.



The mark of responsible forestry

The FSC® certificate applies to responsible forest management and the entire flow of raw materials from the forest to the customer. Each stage of the chain is monitored in terms of social, ecological and economic performance. The product with the FSC® label gives customers a guarantee that the wood used for the production of the product comes from sources managed in a sustainable manner.

Warranty

Manufacturer declares that the products shall be free from defects in material or workmanship. The warranty is given to the original purchaser only, for normal commercial usage. Detailed terms of warranty and warranty periods are available at <https://www.kusch.com/en/warranty>

lupino price list 2026

Lupino

Design by Norbert Geelen

Armchair on 4 metal legs



LUPINO ARMCHAIR
4L



LUPINO ARMCHAIR
4L HAR



LUPINO ARMCHAIR
4L HB



LUPINO ARMCHAIR
4L HB HAR

Armchair on sled metal frame



LUPINO ARMCHAIR
CFS



LUPINO ARMCHAIR
CFS HAR



LUPINO ARMCHAIR
CFS HB



LUPINO ARMCHAIR
CFS HB HAR

Armchair on 4 wooden legs



LUPINO ARMCHAIR
4L LGW



LUPINO ARMCHAIR
4L LGW HAR



LUPINO ARMCHAIR
4L LGW HB



LUPINO ARMCHAIR
4L LGW HB HAR

Swivel armchair



LUPINO ARMCHAIR
SWIVEL



LUPINO ARMCHAIR
SWIVEL HAR



LUPINO ARMCHAIR
SWIVEL HB



LUPINO ARMCHAIR
SWIVEL HB HAR

Lounge swivel armchair



LUPINO LOUNGE ARMCHAIR
4S HB

Leg rest



LUPINO LEG REST

Lupino barstool on plate base



LUPINO HOCKER CO

Hocker on sled metal frame



LUPINO HOCKER CFS

Hocker on 4 wooden legs



LUPINO HOCKER 4L LGW

Price list

Lupino armchair on 4 metal legs

Upholstered shell, with upholstered seat cushion with low or high armrests, Frame powder-coated, removable plastic glides.



| LUPINO ARMCHAIR 4L | LUPINO ARMCHAIR 4L HAR | LUPINO ARMCHAIR 4L HB | LUPINO ARMCHAIR 4L HB HAR |
|--|--|---|---|
| replaces version: • 8610/3 | replaces version: • 8612/3 | replaces version: • 8615/3 | replaces version: • 8617/3 |
| W 640 mm D 670 mm H 830 mm SH 470 mm SH DIN 435 mm WT 10,7 kg | W 690 mm D 670 mm H 830 mm SH 470 mm SH DIN 435 mm WT 11,0 kg | W 640 mm D 740 mm H 1060 mm SH 470 mm SH DIN 435 mm WT 11,0 kg | W 690 mm D 740 mm H 1060 mm SH 470 mm SH DIN 435 mm WT 12,5 kg |

Basic price (EUR) according to upholstery price group

| | | | | | | | | | | |
|-------------------------------|--|-----------------|-----|----|-----|----|-----|----|-----|----|
| | Price group 2 | | 490 | | 541 | | 606 | | 664 | |
| | Price group 3 | | 521 | | 574 | | 638 | | 698 | |
| | Price group 4 | | 536 | | 583 | | 657 | | 712 | |
| | Price group 5 | | 577 | | 596 | | 698 | | 723 | |
| | Price group 6 | | 712 | | 777 | | 849 | | 922 | |
| Frame | powder-coated | E-③ | • | | • | | • | | • | |
| | Steel | chromium plated | | 31 | | 31 | | 31 | | 31 |
| | | satin chrome | E-③ | | 32 | | 32 | | 32 | |
| Shell | Upholstered | BSA-⑤ | • | – | • | – | • | – | • | – |
| | Upholstered with piping | BSA-PI-⑤ | – | 45 | – | 45 | – | 52 | – | 52 |
| Seat | Upholstered seat cushion | SE-PD-⑤ | • | • | • | • | • | • | • | • |
| | Removable upholstered seat cushion | SE-PDR-⑤ | 54 | 54 | 54 | 54 | 54 | 54 | 54 | 54 |
| | Upholstered, integrated with shell – no separate seat cushion (finish in shell colour) | SE | 28 | – | 28 | – | 28 | – | 28 | – |
| Glides | Plastic | GD | • | | • | | • | | • | |
| | Plastic with felt | GDF | 8 | | 8 | | 8 | | 8 | |
| | Protect glides | GDT | 9 | | 9 | | 9 | | 9 | |
| Foam | Standard foam | FSTD | • | | • | | • | | • | |
| | Flame retardant foam | FFR2 | 21 | | 21 | | 25 | | 25 | |
| | Low flammability foam | FFR3 | 66 | | 66 | | 78 | | 78 | |
| Wood and wood-based materials | Raw material from certified forests, FSC certificate – authorized companies | FSC | • | | • | | • | | • | |
| Assembly | Assembled | ASM-F | • | | • | | • | | • | |
| Sample order | LUPINO ARMCHAIR 4L (E-BL BSA-CUZ1E SE-PD-CUZ1E GD FSTD FSC ASM-F) | | | | | | | | | |
| | LUPINO ARMCHAIR 4L HB (E-BL BSA-CUZ1E SE-PD-CUZ1E GD FSTD FSC ASM-F) | | | | | | | | | |

③ – Please specify metal code – [see finishes](#)

⑤ – Please specify upholstery colour code from selected price group – [see finishes](#)

• Available as standard (included in basic price)

General notes

As standard, the upholstery type is the same for each upholstered element, colours may vary

PRICE GROUP 2: Boogie, Cura, Cura Loop, Home, Valencia, Xtreme
 PRICE GROUP 3: Chili, Moulin-Fr, Silvertex, Step/Step Melange
 PRICE GROUP 4: Blazer, Focus Royal, Main Line Flax, Oceanic, skai Parotega, Synergy
 PRICE GROUP 5: Remix 3
 PRICE GROUP 6: Nappa leather

Lupino armchair on sled metal frame

Upholstered shell, with upholstered seat cushion with low or high armrests, powder-coated frame, plastic glides.



| LUPINO ARMCHAIR CFS | LUPINO ARMCHAIR CFS HAR | LUPINO ARMCHAIR CFS HB | LUPINO ARMCHAIR CFS HB HAR |
|--|--|---|---|
| replaces version: • 8630/3 | replaces version: • 8632/3 | replaces version: • 8635/3 | replaces version: • 8637/3 |
| W 640 mm D 670 mm H 830 mm SH 470 mm SH DIN 435 mm WT 10,7 kg | W 690 mm D 670 mm H 830 mm SH 470 mm SH DIN 435 mm WT 12,0 kg | W 640 mm D 740 mm H 1060 mm SH 470 mm SH DIN 435 mm WT 11,0 kg | W 690 mm D 740 mm H 1060 mm SH 470 mm SH DIN 435 mm WT 13,5 kg |

Basic price (EUR) according to upholstery price group

| | | | Price group 2 | Price group 3 | Price group 4 | Price group 5 | Price group 6 | | | |
|-------------------------------|--|-----------------|---------------|---------------|---------------|---------------|---------------|----|----|----|
| Frame | powder-coated | E-(3) | • | • | • | • | • | • | • | • |
| | Steel | chromium plated | 33 | 33 | 33 | 33 | 33 | 33 | 33 | 33 |
| | | satin chrome | E-(3) | 37 | 37 | 37 | 37 | 37 | 37 | 37 |
| Shell | Upholstered | BSA-(5) | • | — | • | — | • | — | • | — |
| | Upholstered with piping | BSA-PI-(5) | — | 45 | — | 45 | — | 52 | — | 52 |
| Seat | Upholstered seat cushion | SE-PD-(5) | • | • | • | • | • | • | • | • |
| | Removable upholstered seat cushion | SE-PDR-(5) | 54 | 54 | 54 | 54 | 54 | 54 | 54 | 54 |
| | Upholstered, integrated with shell – no separate seat cushion (finish in shell colour) | SE | 28 | — | 28 | — | 28 | — | 28 | — |
| Glides | Plastic | GD | • | • | • | • | • | • | • | • |
| | Plastic with felt | GDF | 8 | 8 | 8 | 8 | 8 | 8 | 8 | 8 |
| Foam | Standard foam | FSTD | • | • | • | • | • | • | • | • |
| | Flame retardant foam | FFR2 | 21 | 21 | 25 | 25 | 25 | 25 | 25 | 25 |
| | Low flammability foam | FFR3 | 66 | 66 | 78 | 78 | 78 | 78 | 78 | 78 |
| Wood and wood-based materials | Raw material from certified forests, FSC certificate – authorized companies | FSC | • | • | • | • | • | • | • | • |
| Assembly | Assembled | ASM-F | • | • | • | • | • | • | • | • |

Sample order LUPINO ARMCHAIR CFS (E-BL BSA-CUZ1E SE-PD-CUZ1E GD FSTD FSC ASM-F)

LUPINO ARMCHAIR CFS HB (E-BL BSA-CUZ1E SE-PD-CUZ1E GD FSTD FSC ASM-F)

(3) – Please specify metal code – [see finishes](#)

(5) – Please specify upholstery colour code from selected price group – [see finishes](#)

• Available as standard (included in basic price)

General notes

As standard, the upholstery type is the same for each upholstered element, colours may vary

PRICE GROUP 2: Boogie, Cura, Cura Loop, Home, Valencia, Xtreme
 PRICE GROUP 3: Chilli, Moulin-Fr, Silvertex, Step/Step Melange
 PRICE GROUP 4: Blazer, Focus Royal, Main Line Flax, Oceanic, skai Parotega, Synergy
 PRICE GROUP 5: Remix 3
 PRICE GROUP 6: Nappa leather

Price list

Lupino armchair on 4 wooden legs

Upholstered shell, upholstered seat cushion with low or high armrests.
Frame made of beech wood, plastic glides.



| LUPINO ARMCHAIR 4L LGW | LUPINO ARMCHAIR 4L LGW HAR | LUPINO ARMCHAIR 4L LGW HB | LUPINO ARMCHAIR 4L LGW HB HAR |
|--|--|---|---|
| replaces version: • 8680/3 | replaces version: • 8682/3 | replaces version: • 8685/3 | replaces version: • 8687/3 |
| W 640 mm D 670 mm H 830 mm SH 470 mm SH DIN 435 mm WT 10,0 kg | W 690 mm D 670 mm H 830 mm SH 470 mm SH DIN 435 mm WT 10,5 kg | W 640 mm D 740 mm H 1060 mm SH 470 mm SH DIN 435 mm WT 10,3 kg | W 690 mm D 740 mm H 1060 mm SH 470 mm SH DIN 435 mm WT 12,0 kg |

Basic price (EUR) according to upholstery price group

| | | | | | | | | | |
|-------------------------------|--|----------|-----|----|-----|----|-----|----|------|
| | Price group 2 | | 574 | | 630 | | 689 | | 753 |
| | Price group 3 | | 604 | | 663 | | 721 | | 787 |
| | Price group 4 | | 622 | | 677 | | 741 | | 803 |
| | Price group 5 | | 660 | | 686 | | 781 | | 813 |
| | Price group 6 | | 794 | | 866 | | 932 | | 1011 |
| Frame | Beech wood | natural | • | | • | | • | | • |
| | | stained | E-① | 16 | 16 | 16 | 16 | | |
| | Oak wood | natural | 79 | 79 | 79 | 79 | | | |
| Shell | Upholstered | BSA-⑤ | • | – | • | – | • | – | • |
| | Upholstered with piping | BSA-PI-⑤ | – | 45 | – | 45 | – | 52 | – |
| Seat | Upholstered seat cushion | SE-PD-⑤ | • | • | • | • | • | • | • |
| | Removable upholstered seat cushion | SE-PDR-⑤ | 54 | 54 | 54 | 54 | 54 | 54 | 54 |
| | Upholstered, integrated with shell – no separate seat cushion (finish in shell colour) | SE | 28 | – | 28 | – | 28 | – | 28 |
| Glides | Plastic | GD | • | | • | | • | | • |
| | Plastic with felt | GDF | 8 | | 8 | | 8 | | 8 |
| Foam | Standard foam | FSTD | • | | • | | • | | • |
| | Flame retardant foam | FFR2 | 21 | | 21 | | 25 | | 25 |
| | Low flammability foam | FFR3 | 66 | | 66 | | 78 | | 78 |
| Wooden elements lacquering | Water lacquer UV | UV | • | | • | | • | | • |
| | Water lacquer | | –20 | | –20 | | –20 | | –20 |
| Wood and wood-based materials | Raw material from certified forests, FSC certificate – authorized companies | FSC | • | | • | | • | | • |
| Assembly | Assembled | ASM-F | • | | • | | • | | • |
| Sample order | LUPINO ARMCHAIR 4L LGW (E-SKNB BSA-CUZ1E SE-PD-CUZ1E GD FSTD UV FSC ASM-F) | | | | | | | | |
| | LUPINO ARMCHAIR 4L LGW HB (E-SKNB BSA-CUZ1E SE-PD-CUZ1E GD FSTD UV FSC ASM-F) | | | | | | | | |

③ – Please specify metal code – see finishes

⑤ – Please specify upholstery colour code from selected price group – see finishes

• Available as standard (included in basic price)

General notes

As standard, the upholstery type is the same for each upholstered element, colours may vary

PRICE GROUP 2: Boogie, Cura, Cura Loop, Home, Valencia, Xtreme
PRICE GROUP 3: Chili, Moulin-Fr, Silvertex, Step/Step Melange
PRICE GROUP 4: Blazer, Focus Royal, Main Line Flax, Oceanic, skai Parotega, Synergy
PRICE GROUP 5: Remix 3
PRICE GROUP 6: Nappa leather

Lupino swivel armchair

Upholstered shell, upholstered seat cushion.
 Ø 720 mm four-star base, powder-coated aluminium,
 chromium plated column or powder-coated in black colour,
 plastic glides.



| LUPINO ARMCHAIR SWIVEL | LUPINO ARMCHAIR SWIVEL HAR | LUPINO ARMCHAIR SWIVEL HB | LUPINO ARMCHAIR SWIVEL HB HAR |
|--|--|---|---|
| replaces versions: • 8640/3 • 8650/3 | replaces versions: • 8642/3 • 8652/3 | replaces versions: • 8645/3 • 8655/3 | replaces versions: • 8647/3 • 8657/3 |
| W 640 mm D 670 mm H 830 mm SH 470 mm SH DIN 435 mm WT 11,1 kg | W 810 mm D 670 mm H 830 mm SH 470 mm SH DIN 435 mm WT 12,0 kg | W 640 mm D 740 mm H 1060 mm SH 470 mm SH DIN 435 mm WT 11,4 kg | W 810 mm D 740 mm H 1060 mm SH 470 mm SH DIN 435 mm WT 13,5 kg |

Basic price (EUR) according to upholstery price group

| | | | 578 | 634 | 692 | 757 | | | | |
|---------------------|---|----------|-----|-----|-----|------|----|----|----|----|
| Price group 2 | | | | | | | | | | |
| Price group 3 | | | 608 | 668 | 726 | 792 | | | | |
| Price group 4 | | | 625 | 681 | 746 | 810 | | | | |
| Price group 5 | | | 664 | 690 | 785 | 817 | | | | |
| Price group 6 | | | 798 | 871 | 936 | 1017 | | | | |
| Shell | Upholstered | BSA-⑤ | • | – | • | – | • | – | | |
| | Upholstered with piping | BSA-PI-⑤ | – | 45 | – | 45 | – | 52 | – | 52 |
| Seat | Upholstered seat cushion | SE-PD-⑤ | • | • | • | • | • | • | • | • |
| | Removable upholstered seat cushion | SE-PDR-⑤ | 54 | 54 | 54 | 54 | 54 | 54 | 54 | 54 |
| | Upholstered, integrated with shell – no separate seat cushion (finish in the colour of shell) | SE | 28 | – | 28 | – | 28 | – | 28 | – |
| Column/ Gas lift | 470 mm fixed seat height | CO-STD | • | – | • | – | • | – | • | – |
| | 450 mm fixed seat height, relax version – shell tilted back | CO-RX | 14 | – | 14 | – | 14 | – | 14 | – |
| | Seat height adjustment in range of 440 – 560 mm | GL-STD | 27 | – | 27 | – | 27 | – | 27 | – |
| | Seat height adjustment in range of 430 – 550 mm, with rocking mechanism | GL-RO | 39 | – | 39 | – | 39 | – | 39 | – |
| Base* | Powder-coated | ST63-③ | • | – | • | – | • | – | • | – |
| | Polished aluminium | ST63-POL | 20 | – | 20 | – | 20 | – | 20 | – |

* For powder-coated base in Jet black colour, column or gas lift and mechanism cover in black colour,
 for the other colour of base, column or gas lift finish: chrome, mechanism cover finish: polished aluminium

③ – Please specify metal code – [see finishes](#)

⑤ – Please specify upholstery colour code from selected price group – [see finishes](#)

• Available as standard (included in basic price)

General notes

As standard, the upholstery type is the same for each upholstered element, colours may vary

PRICE GROUP 2: Boogie, Cura, Cura Loop, Home, Valencia, Xtreme
 PRICE GROUP 3: Chili, Moulin-Fr, Silvertex, Step/Step Melange
 PRICE GROUP 4: Blazer, Focus Royal, Main Line Flax, Oceanic, skai Parotega, Synergy
 PRICE GROUP 5: Remix 3
 PRICE GROUP 6: Nappa leather

Price list

| | | | LUPINO ARMCHAIR SWIVEL | LUPINO ARMCHAIR SWIVEL HAR | LUPINO ARMCHAIR SWIVEL HB | LUPINO ARMCHAIR SWIVEL HB HAR |
|--------------------------------------|--|--|------------------------|----------------------------|---------------------------|-------------------------------|
| Glides / Castors | Plastic | GD | • | • | • | • |
| | Plastic with felt | GDF | 9 | 9 | 9 | 9 |
| | Non-skid glides | GDN | 6 | 6 | 6 | 6 |
| | Plastic castors for soft floors | Applicable only for armchair with seat height adjustment | CA | 9 | 9 | 9 |
| | Plastic castors for hard floors | | CAH | | | |
| Foam | Standard foam | FSTD | • | • | • | • |
| | Flame retardant foam | FFR2 | 21 | 21 | 25 | 25 |
| | Low flammability foam | FFR3 | 66 | 66 | 78 | 78 |
| Wood and wood-based materials | Raw material from certified forests, FSC certificate – authorized companies | FSC | • | • | • | • |
| Assembly | Assembled | ASM-F | • | • | • | • |
| Sample order | LUPINO ARMCHAIR SWIVEL (BSA-CUZ1E SE-PD-CUZ1E GL-STD ST63-WK GD FSTD FSC ASM-F) | | | | | |
| | LUPINO ARMCHAIR SWIVEL HB (BSA-CUZ1E SE-PD-CUZ1E GL-STD ST63-WK GD FSTD FSC ASM-F) | | | | | |

- Available as standard (included in basic price)

Lupino Lounge swivel armchair

Fully upholstered seat shell.
Base made of aluminium powder-coated in Jet Black (RAL9005) colour,
plastic glides for soft floors.



LUPINO LOUNGE ARMCHAIR 4S HB

W 800 mm
D 800 mm
H 1075 mm
SH 460 mm
WT 20,0 kg

Basic price (EUR)

1495

| | | | | |
|-----------------|---------------------------------------|---------------------|----------|---|
| Shell | Upholstered | skai Parotega | BS-⑤ | • |
| Base | Powder-coated steel | Jet Black, RAL 9005 | BC-BL | • |
| Glides | Plastic glides | | GD | • |
| Foam | Flame retardant with fireproof fabric | | FFRF | • |
| Assembly | Assembled, cardboard packaging | | PACK-ASM | • |

Sample order LUPINO LOUNGE ARMCHAIR 4S HB (BS-NF662 BC-BL GD FFRF PACK-ASM)

⑤ – Please specify upholstery colour code from selected price group – [see finishes](#)

- Available as standard (included in basic price)

Price list

Lupino leg rest

Ø 720 mm four-star base, powder-coated aluminium, chromium plated gas lift or powder-coated in black colour.



LUPINO LEG REST

replaces version:
• 8650/0

W 550 mm
D 760 mm
SH 390 – 510 mm
SH DIN 380 – 500 mm
WT 6,4 kg

Basic price (EUR) according to upholstery price group

| | | | | |
|--------------------------------------|---|-----------------|-----|---|
| | Price group 2 | | 268 | |
| | Price group 3 | | 276 | |
| | Price group 4 | | 280 | |
| | Price group 5 | | 293 | |
| | Price group 6 | | 333 | |
| Leg rest pad | Upholstered | SE-⑤ | • | |
| Gas lift | Height adjustment in range of 390 – 510 mm | GL-STD | • | |
| Base* | Powder-coated | ST63-③ | • | |
| | Polished aluminium | ST63-POL | 20 | |
| Glides / Castors | Plastic | GD | • | |
| | Plastic with felt | GDF | 9 | |
| | Non-skid glides | GDN | 6 | |
| | Plastic castors | for soft floors | CA | 9 |
| | | for hard floors | CAH | |
| Foam | Standard foam | FSTD | • | |
| | Flame retardant foam | FFR2 | 9 | |
| | Low flammability foam | FFR3 | 24 | |
| Wood and wood-based materials | Raw material from certified forests, FSC certificate – authorized companies | FSC | • | |
| Assembly | Assembled | ASM-F | • | |
| Sample order | LUPINO LEG REST (SE-CUZ1E GL-STD ST63-WK GD FSTD FSC ASM-F) | | | |

* For powder-coated base in Jet black colour, column or gas lift and mechanism cover in black colour,
for the other colour of base, column or gas lift finish: chrome, mechanism cover finish: polished aluminium

③ – Please specify metal code – [see finishes](#)

⑤ – Please specify upholstery colour code from selected price group – [see finishes](#)

• Available as standard (included in basic price)

PRICE GROUP 2: Boogie, Cura, Cura Loop, Home, Valencia, Xtreme
PRICE GROUP 3: Chili, Moulin-Fr, Silvertex, Step/Step Melange
PRICE GROUP 4: Blazer, Focus Royal, Main Line Flax, Oceanic, skai Parotega, Synergy
PRICE GROUP 5: Remix 3
PRICE GROUP 6: Nappa leather

Lupino barstool on plate base

Upholstered shell.

Base (column and base plate) made of powder-coated steel, powder-coated or polished aluminium footrest, plastic glides



LUPINO HOCKER CO

W 515 mm
D 505 mm
H 950 mm
SH 810 mm
SH DIN 795 mm
WT 19,0 kg

Basic price (EUR) according to upholstery price group

| | | | | |
|--------------------------------------|---|------------------------------------|----------|-----|
| | Price group 2 | | | 559 |
| | Price group 3 | | | 564 |
| | Price group 4 | | | 577 |
| | Price group 5 | | | 590 |
| | Price group 6 | | | 715 |
| Version | Freestanding | V-FS | • | — |
| | Fixed to floor | V-FF | — | ○ |
| Shell | Upholstered | BSA-⑤ | • | |
| Base | Column and plate: powder-coated steel | Jet black, RAL 9005 | BC-BL | • |
| Footrest | Powder-coated aluminium | Jet black, RAL 9005 | FB-BL | • |
| | Polished aluminium | | FB-POL | ○ |
| Floor fixing | Glued | | FF-G | • |
| | Screwed | | FF-S | 20 |
| Glides | Plastic | | GD | • |
| | Plastic with felt | | GDF | ○ |
| Foam | Flame retardant foam | | FFR2 | • |
| | Low flammability foam | | FFR3 | 45 |
| Wood and wood-based materials | Raw material from certified forests, FSC certificate – authorized companies | | FSC | • |
| Assembly | Assembled, cardboard packaging | (for freestanding version) | PACK-ASM | • |
| | | (for floor-fixed version, glued) | | • |
| | Unassembled, cardboard packaging | (for floor-fixed version, screwed) | PACK-UA | — |

Sample order LUPINO HOCKER CO (V-FF BSA-SX4001 BC-BL FB-POL FF-G FFR2 FSC PACK-ASM)

⑤ – Please specify upholstery colour code from selected price group – see finishes

- Available as standard (included in basic price)
- Available as an option (included in basic price)

PRICE GROUP 2: Cura, Cura Loop, Valencia, Xtreme
PRICE GROUP 3: Silvertex, Step/Step Melange
PRICE GROUP 4: Blazer, Main Line Flax, Oceanic, skai Parotega, Synergy
PRICE GROUP 5: Remix 3
PRICE GROUP 6: Arona, Nappa leather

Price list

Lupino barstool on sled metal frame

Upholstered shell.

Base: powder-coated sled frame with integrated footrest, plastic glides.



LUPINO HOCKER CFS

W 515 mm
D 500 mm
H 950 mm
SH 810 mm
SH DIN 795 mm
WT 10,0 kg

Basic price (EUR) according to upholstery price group

| | | | |
|--------------------------------------|---|-------------------|------------------|
| | Price group 2 | | 405 |
| | Price group 3 | | 422 |
| | Price group 4 | | 424 |
| | Price group 5 | | 447 |
| | Price group 6 | | 557 |
| Shell | Upholstered | BSA- ^⑤ | • |
| Base | Steel | powder-coated | BC- ^③ |
| | | chromium plated | BC-CR |
| Footrest | Steel in base colour | FB- ^③ | • |
| Glides | Plastic | GD | • |
| | Plastic with felt | GDF | ◦ |
| Foam | Standard foam | FSTD | • |
| | Flame retardant foam | FFR2 | 18 |
| | Low flammability foam | FFR3 | 55 |
| Wood and wood-based materials | Raw material from certified forests, FSC certificate – authorized companies | FSC | • |
| Assembly | Assembled, cardboard packaging | PACK-ASM | • |

Sample order LUPINO HOCKER CFS (BSA-SX4001 BC-CR FB-CR GD FFR2 FSC PACK-ASM)

^③ – Please specify metal code – [see finishes](#)

^⑤ – Please specify upholstery colour code from selected price group – [see finishes](#)

- Available as standard (included in basic price)
- Available as an option (included in basic price)

PRICE GROUP 2: Cura, Cura Loop, Valencia, Xtreme
PRICE GROUP 3: Silvertex, Step/Step Melange
PRICE GROUP 4: Blazer, Main Line Flax, Oceanic, skai Parotega, Synergy
PRICE GROUP 5: Remix 3
PRICE GROUP 6: Nappa leather

Lupino barstool on 4 wooden legs

Upholstered shell.

Base: 4 solid beech wooden legs, metal footrest powder-coated in black colour RAL 9005 Jet black, plastic glides.



LUPINO HOCKER 4L LGW

W 515 mm
D 460 mm
H 950 mm
SH 810 mm
SH DIN 795 mm
WT 9,7 kg

Basic price (EUR) according to upholstery price group

| | | | | | |
|--------------------------------------|---|---------------------|----------|--|------|
| | Price group 2 | | | | 537 |
| | Price group 3 | | | | 554 |
| | Price group 4 | | | | 556 |
| | Price group 5 | | | | 579 |
| | Price group 6 | | | | 689 |
| Shell | Upholstered | | BSA-⑤ | | • |
| Base | Beech wood | Natural | | | • |
| | | Stained | BC-① | | 15 |
| | Oak wood | Natural | | | 75 |
| Footrest | Powder-coated steel | Jet black, RAL 9005 | FB-BL | | • |
| Glides | Plastic | | GD | | • |
| | Plastic with felt | | GDF | | 8 |
| Foam | Standard foam | | FSTD | | • |
| | Flame retardant foam | | FFR2 | | 18 |
| | Low flammability foam | | FFR3 | | 55 |
| Wooden elements lacquering | Water lacquer UV | | UV | | • |
| | Water lacquer | | | | - 20 |
| Wood and wood-based materials | Raw material from certified forests, FSC certificate – authorized companies | | FSC | | • |
| Assembly | Assembled, cardboard packaging | | PACK-ASM | | • |
| Sample order | LUPINO HOCKER 4L LGW (BSA-SX4001 BC-CR FB-BL GD FFR2 UV FSC PACK-ASM) | | | | |

① – Please specify wood colour code – [see finishes](#)

⑤ – Please specify upholstery colour code from selected price group – [see finishes](#)

- Available as standard (included in basic price)

PRICE GROUP 2: Cura, Cura Loop, Valencia, Xtreme
PRICE GROUP 3: Silvertex, Step/Step Melange
PRICE GROUP 4: Blazer, Main Line Flax, Oceanic, skai Parotega, Synergy
PRICE GROUP 5: Remix 3
PRICE GROUP 6: Nappa leather

Finishes

Wood

Natural



SKNB

Natural
Beech



SKNO

Natural Oak

Stained



2.07Y

Black



2.06S

Slate



S39

Light Grey



2.09S

White



2.0CB

Acacia



SK40

Oak



2.0CC

Walnut

Metal



**NCS S
2005-Y60R**
Cashmere
NK



RAL 1024
Ochre Yellow
OY



**RAL 030
50 40**
Vermilion
Red
VR



RAL 6003
Olive Green
OG



RAL 5000
Violet Blue
VB



Chrome
CR



**Satin
Chrome**
SCR



**Polished
Aluminium**
POL



RAL 9003
Signal White
WS



RAL 9006
White
Aluminium
WK



Silver 98
SV



DB 703
Iron Mica
IM



RAL 9005
Jet Black
BL

Metal

for Hocker



**Polished
Aluminium**
POL



RAL 9005
Jet Black
BL

for Lupino Lounge



RAL 9005
Jet Black
BL

General notes

All specified dimensions are approximate. Subject to minor modifications or differences for reasons of design improvements or for technical reasons.

- W = width
- D = depth
- H = height
- DI = diameter
- SH = seat height
- SH DIN = seat height measured acc. to DIN EN 1335-1

In compliance with the highest quality standards "Quality is irreplaceable." Guided by this principle, each product line is subjected to stringent quality testing.

Only the products marked in this document are FSC® (FSC®-C120977).

Look for our FSC®-certified products. Sale of products that meet the FSC® requirements is possible only by Nowy Styl Sp. z o.o., Nowy Styl Nederland B.V. and Kusch + Co GmbH.



The mark of responsible forestry

The FSC® certificate applies to responsible forest management and the entire flow of raw materials from the forest to the customer. Each stage of the chain is monitored in terms of social, ecological and economic performance. The product with the FSC® label gives customers a guarantee that the wood used for the production of the product comes from sources managed in a sustainable manner.

Warranty

Manufacturer declares that the products shall be free from defects in material or workmanship. The warranty is given to the original purchaser only, for normal commercial usage.

Detailed terms of warranty and warranty periods are available at

<https://www.kusch.com/en/warranty>

papilio price list 2026

Papilio

Design by Justus Kolberg

Office swivel chair



PAPILIO SWIVEL
CHAIR UPH



PAPILIO SWIVEL
CHAIR HB UPH



PAPILIO SWIVEL
CHAIR HB MESH



kuschmed[®]
HYGIENIC-LINE

PAPILIO SWIVEL
CHAIR HYG HB
UPH

Price list

Office swivel chair

Base and backrest support made of black plastic, plastic parts black, synchronous mechanism with seat depth adjustment, comfort gas action with permanent depth cushioning, upholstered seat with side drops in the same upholstery type and colour, standard foam, upholstered or mesh backrest with height adjustment, castors for soft floors.



| PAPILIO SWIVEL CHAIR UPH | PAPILIO SWIVEL CHAIR HB UPH | PAPILIO SWIVEL CHAIR HB MESH |
|---|--|--|
| replaces versions: • 9256/1 • 9256/3 | replaces versions: • 9257/1 • 9257/3 | replaces versions: • 9227/1 • 9227/3 |
| W 710 mm D 710–820 mm H 950–1150 mm SH DIN 420–530 mm WT 18,5 kg | W 710 mm D 710–820 mm H 1040–1240 mm SH DIN 420–530 mm WT 19,0 kg | W 710 mm D 710–820 mm H 1070–1180 mm SH DIN 420–530 mm WT 16,5 kg |

Basic price (EUR)
according to upholstery price group

| | | | | 634 | 643 | 647 | |
|-----------------------|--|---|---------------|-----------|-----------|-----------|-----|
| | Price group 2 | | | | | | |
| | Price group 3 | | | 657 | 665 | 656 | |
| | Price group 4 | | | 686 | 695 | 667 | |
| | Price group 5 | | | 706 | 716 | 674 | |
| | Price group 6 | | | 938 | 946 | 760 | |
| Mechanism | Synchronous mechanism with seat depth adjustment | SP-ST | | • | • | • | |
| | Synchronous mechanism with seat depth adjustment and negative seat inclination | SPN-ST | | 37 | 37 | 37 | |
| Headrest | No headrest | | | • | • | • | |
| | Headrest, black plastic with soft polyurethane pad | HRP | | – | 33 | 33 | |
| | Headrest, black plastic with upholstered pad | Fabric Leather | HRU-⑤ | – | 90 128 | 90 128 | |
| Lumbar support | No lumbar support | | | • | • | • | |
| | Pneumatic, with depth adjustment | LND2 | | – | 101 | – | |
| | Manual, with height and depth adjustment | LU4 | | – | – | 40 | |
| Backrest | Upholstered | | | • | • | – | |
| | Harlequin 3D fabric | BA-⑤ | | – | – | • | |
| | Mesh in black colour | BA-KR.4716.10 | | – | – | • | |
| Seat | Upholstered with side drops (side drops upholstered in seat colour) | SE-SD-⑤ | | • | • | • | |
| | Upholstered only with Xtreme fabric | SE-⑤ | | -47 | -47 | -47 | |
| Armrests | None | | | • | • | • | |
| | Type: 2D | Bar: Black plastic | Pad: Black PU | R80-B/BPU | 100 | 100 | 100 |
| | Type: 3D | | | R81-B/BPU | 134 | 134 | 134 |
| Gas lift | Seat height adjustment in range of 420 – 530 mm | GL-STD | | • | • | • | |
| | | Black polyamide | TS30 | • | • | • | |
| | | Aluminium powder-coated in black colour | ST56-BL | 30 | 30 | 30 | |
| Base | | Polished aluminium with chrome effect | ST56-POL | 50 | 50 | 50 | |
| | Ø 735 mm five-star | | | | | | |
| Castors | Ø 60 mm | For soft floors | CA | • | • | • | |
| | | For hard floors | CAH | ○ | ○ | ○ | |
| Foam | Standard foam | FSTD | | • | • | • | |

Sample order PAPILIO SWIVEL CHAIR UPH (SP-ST BA-XR009 SE-XR009 GL-STD TS30 CA FSTD)

⑤ – Please specify upholstery colour code from selected price group – [see finishes](#)

- Available as standard (included in basic price)
- Available as an option (included in basic price)

PRICE GROUP 2: Cura, Cura Loop, Valencia, Xtreme
 PRICE GROUP 3: Silvertex, Step/Step Melange
 PRICE GROUP 4: Blazer, Main Line Flax, skai Parotega, Synergy
 PRICE GROUP 5: Remix 3
 PRICE GROUP 6: Nappa leather

Office swivel chair with enhanced hygienic properties

The ergonomic swivel chair fulfilling the highest cleanliness and hygiene requirements. Easily accessible, large surfaces that are easy to clean and disinfect. Seat and backrest are upholstered. Seat with seamless upholstery, additionally equipped with a protective profile to prevent the upholstery from mechanical damage. Upholstery robust, impervious to liquids and resistant to disinfectants. The flexibility of the height adjustable backrest works well even in cramped working areas, not limiting the rotation of the upper body. Synchronous mechanism with seat depth adjustment, comfort gas action with permanent depth cushioning. Base and backrest support made of plastic. All plastic parts are in black colour.



PAPILIO SWIVEL CHAIR HYG HB UPH

replaces versions:

- 9251/1
- 9251/3

W 710 mm
D 710 – 820 mm
H 1040 – 1240 mm
SH DIN 420 – 530 mm
WT 19,0 kg

Basic price (EUR)

649

| | | | |
|------------------|--|--------------------|---------------|
| Mechanism | Synchronous mechanism | SP | • |
| | No headrest | | • |
| Headrest | Headrest, black plastic with soft polyurethane pad | HRP | 33 |
| | Headrest, black plastic with upholstered pad | HRU-⑤ | 90 |
| Backrest | Upholstered | BA-⑤ | • |
| Seat | Upholstered (seamless upholstery) | SE-⑤ | • |
| | None | | • |
| Armrests | Type: 2D | Bar: Black plastic | Pad: Black PU |
| | Type: 3D | | |
| | | R80-B/BPU | 100 |
| | | R81-B/BPU | 134 |
| Gas lift | Seat height adjustment in range of 420 – 530 mm | GL-STD | • |
| Base | Ø 735 mm five-star | Black polyamide | TS30 |
| | | | • |
| Castors | Ø 60 mm | For soft floors | CA |
| | | For hard floors | CAH |
| | | | ○ |
| Foam | Standard foam | FSTD | • |

Sample order PAPILIO SWIVEL CHAIR HYG HB UPH (SP HRU-NF657 BA-NF657 SE-NF657 R80-B/BPU GL-STD TS30 CA FSTD)

⑤ – Please specify upholstery colour code from selected price group – [see finishes](#)

- Available as standard (included in basic price)
- Available as an option (included in basic price)

Finishes

Mesh KR.4716.10

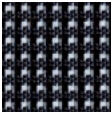

KR.4716.10

General notes

All specified dimensions are approximate. Subject to minor modifications or differences for reasons of design improvements or for technical reasons.

- W = width
- D = depth
- H = height
- DI = diameter
- SH = seat height
- SH DIN = seat height measured acc. to DIN EN 1335-1

In compliance with the highest quality standards "Quality is irreplaceable." Guided by this principle, each product line is subjected to stringent quality testing.

Warranty

Manufacturer declares that the products shall be free from defects in material or workmanship. The warranty is given to the original purchaser only, for normal commercial usage.

Detailed terms of warranty and warranty periods are available at

<https://www.kusch.com/en/warranty>

colani price list 2026

Colani

Design by Prof. Luigi Colani

Armchair



COLANI ARMCHAIR 1

Chaise longue



COLANI LOUNGECHAIR

Price list

Colani armchair

Entirely upholstered piece of furniture, plastic glides.



COLANI ARMCHAIR 1

W 830 mm
D 1000 mm
H 710 mm
SH 400 mm
WT 21 kg

Basic price (EUR) according
to upholstery price group

| | | | |
|---------------------|--|----------|------|
| Price group 2 | | | 2862 |
| Price group 3 | | | 2875 |
| Price group 4 | | | 2950 |
| Price group 6 | | | 3654 |
| Finish | Upholstered | ⑤ | • |
| Glides | Black, plastic | GD | • |
| | Black, metal with floor screwing or gluing options | GDG | ○ |
| Assembly | Assembled, cardboard packaging | PACK-ASM | • |
| Sample order | COLANI ARMCHAIR 1 (SX4001 GDG PACK-ASM) | | |

⑤ – Please specify upholstery colour code from selected price group – [see finishes](#)

- Available as standard (included in basic price)
- Available as an option (included in basic price)

Price list

Colani chaise longue

Fully upholstered chaise longue. Metal glides fixed to floor.



COLANI LOUNGECHAIR

W 960 mm
D 2000 mm
H 780 mm
SH 400 mm
WT 46 kg

Basic price (EUR) according
to upholstery price group

| | |
|---------------|------|
| Price group 2 | 4317 |
| Price group 3 | 4336 |
| Price group 4 | 4450 |
| Price group 6 | 5512 |

| | | | | |
|---------------------|--|---------------------------------------|----------|---|
| Finish | Upholstered | ⑤ | • | |
| Glides | Black, metal | with floor screwing or gluing options | GDG | ◦ |
| Assembly | Assembled, cardboard packaging | | PACK-ASM | • |
| Sample order | COLANI LOUNGECHAIR (SX4001 GDG PACK-ASM) | | | |

⑤ – Please specify upholstery colour code from selected price group – [see finishes](#)

- Available as standard (included in basic price)
- Available as an option (included in basic price)

General notes

All specified dimensions are approximate. Subject to minor modifications or differences for reasons of design improvements or for technical reasons.

- W = width
- D = depth
- H = height
- DI = diameter
- SH = seat height
- SH DIN = seat height measured acc. to DIN EN 1335-1

In compliance with the highest quality standards "Quality is irreplaceable." Guided by this principle, each product line is subjected to stringent quality testing.

Warranty

Manufacturer declares that the products shall be free from defects in material or workmanship. The warranty is given to the original purchaser only, for normal commercial usage. Detailed terms of warranty and warranty periods are available at <https://www.kusch.com/en/warranty>

pinta price list 2026

Pinta

Design: Robert de le Roi

Meeting table



PINTA MEETING
TABLE SQ



PINTA MEETING
TABLE RC

Table



PINTA TABLE
SQ



PINTA TABLE
RC

Price list

Pinta meeting table SQ

Square table top.
25 mm table top thickness for Melamine (MFC) finish.
27 mm table top thickness for Laminate finish.
Base – square wooden legs.



PINTA MEETING TABLE SQ

| | | H (mm) | 740/715* Melamine (MFC) 742 / 715* Laminate | | | | | |
|--------------------------------------|---|--|--|------|------|------|------|--|
| | | WT (kg) | 14,8 | 17,3 | 20,2 | 23,4 | 26,2 | |
| Width (mm) | W... | 600 | 700 | 800 | 900 | 1000 | | |
| Depth (mm) | D... | 600 | 700 | 800 | 900 | 1000 | | |
| | | Basic price (EUR) according to table top finishes | | | | | | |
| Melamine (MFC) | | 332 | 338 | 355 | 369 | 395 | | |
| Laminate | | 481 | 488 | 514 | 534 | 571 | | |
| Table top board core | Chipboard | FSP | | | | | • | |
| Table top finish | Melamine (MFC) | Edge: 2 mm glue technology | ①/② | | | | • | |
| | | Protective edge: 2 mm glue technology | ①/②-PE | | | 85 | | |
| | Laminate | Edge: 2 mm glue technology | ①/② | | | | • | |
| | | Protective edge: 2 mm glue technology | ①/②-PE | | | 85 | | |
| Base finish | Metal plate: powder-coated in Silver 98 colour | Solid wood: Natural beech | BC-SV/① | | | | • | |
| | | Stained beech | | | 13 | | | |
| Glides | Plastic glides | GD | | | | | • | |
| | Plastic glides with felt | GDF | | | | | o | |
| Table top connectors | No connector | | | | | | • | |
| | Plastic connector | TC | | | 52 | | | |
| Wood and wood-based materials | Raw material – EU Timber regulation | EUTR | | | | | • | |
| Wooden elements lacquering | Water lacquer UV | UV | | | | | • | |
| | Water lacquer | | | | - 20 | | | |
| Assembly | Assembled | ASM-F | | | | | • | |
| Sample order | PINTA MEETING TABLE SQ (W700 D700 FSP KBU BC-SV/SKNB GD TC EUTR UV ASM-F) | | | | | | | |

* x/y mm – x: overall height/y: height under table top

① – Please specify table top colour code/solid wood colour code – [see finishes](#)

② – Please specify table top edge finish – [see finishes](#)

• Available as standard (included in basic price).

o Available as an option (included in basic price).

Price list

Pinta meeting table RC

Rectangular table top.
25 mm table top thickness for Melamine (MFC) finish.
27 mm table top thickness for Laminate finish.
Base – square wooden legs.



PINTA MEETING TABLE RC

| H (mm) | | 740/715* Melamine (MFC) 742 / 715* Laminate | | | | | | | | | | | |
|--------------------------------------|-------------------------------------|--|----------------------|---------------|---------|------|------|------|------|------|------|------|------|
| | | WT (kg) | 17,1 | 17,8 | 21,1 | 20,7 | 26,6 | 30,5 | 26,2 | 29,3 | 34,8 | 36,7 | 40,0 |
| Width (mm) | W... | 800 | 900 | 1200 | 1000 | 1400 | 1500 | 1200 | 1400 | 1600 | 1800 | 1800 | |
| Depth (mm) | D... | 600 | 600 | 600 | 700 | 700 | 750 | 800 | 800 | 800 | 800 | 900 | |
| | | Basic price (EUR) according to table top finishes | | | | | | | | | | | |
| Melamine (MFC) | | 341 | 355 | 373 | 369 | 386 | 433 | 382 | 396 | 463 | 514 | 565 | |
| Laminate | | 493 | 514 | 540 | 534 | 558 | 628 | 553 | 574 | 670 | 745 | 818 | |
| Table top board core | Chipboard | FSP | | | | | | | | | | • | |
| Table top finish | Melamine (MFC) | Edge: | 2 mm glue technology | ① / ② | | | | | | | | • | |
| | | Protective edge: | 2 mm glue technology | ① / ②-PE | | | | | | | | | 85 |
| | Laminate | Edge: | 2 mm glue technology | ① / ② | | | | | | | | | • |
| | | Protective edge: | 2 mm glue technology | ① / ②-PE | | | | | | | | | 85 |
| Base finish | Metal plate: | powder-coated in Silver 98 colour | Solid wood: | Natural beech | BC-SV/① | | | | | | | • | |
| | | | | Stained beech | | | | | | | | | 13 |
| Glides | Plastic glides | | | GD | | | | | | | | • | |
| | Plastic glides with felt | | | GDF | | | | | | | | ◦ | |
| Table top connectors | No connector | | | | | | | | | | | • | |
| | Plastic connector | | | TC | | | | | | | | 52 | |
| Wood and wood-based materials | Raw material – EU Timber regulation | | | EUTR | | | | | | | | • | |
| Wooden elements lacquering | Water lacquer UV | | | UV | | | | | | | | • | |
| | Water lacquer | | | | | | | | | | | -20 | |
| Assembly | Assembled | | | ASM-F | | | | | | | | • | |

Sample order PINTA MEETING TABLE RC (W1400 D800 FSP KBU BC-SV/SKNB GD TC EUTR UV ASM-F)

* x/y mm – x: overall height/y: height under table top

① – Please specify table top colour code/solid wood colour code – [see finishes](#)

② – Please specify table top edge finish – [see finishes](#)

- Available as standard (included in basic price).
- Available as an option (included in basic price).

Pinta table SQ

Square table top.
25 mm table top thickness for Melamine (MFC) finish.
27 mm table top thickness for Laminate finish.
Base – square wooden legs.



PINTA TABLE SQ

| | | | | | |
|--------------------------------------|---|---|----------------------------|--|------|
| | | H (mm) | | 740/715* Melamine (MFC) 742 / 715* Laminate | |
| | | WT (kg) | | 12,78 | |
| | | Width (mm) | W... | 600 | |
| | | Depth (mm) | D... | 600 | |
| | | | | Basic price (EUR) according to table top finishes | |
| | | Melamine (MFC) | | 316 | |
| | | Laminate | | 457 | |
| Height | | 450 mm (448 mm for Melamine MFC, 450 mm for Laminate) | H450 | | • |
| | | 500 mm (498 mm for Melamine MFC, 500 mm for Laminate) | H500 | | ◦ |
| Table top board core | | Chipboard | FSP | | • |
| | Table top finish | Melamine (MFC) | Edge: 2 mm glue technology | ①/② | • |
| Laminate | | | | | |
| Base finish | Metal plate: powder-coated in Silver 98 colour | Solid wood: | Natural beech | BC-SV/① | • |
| | | | Stained beech | | 13 |
| Glides | | Plastic glides | GD | | • |
| | | Plastic glides with felt | GDF | | ◦ |
| Wood and wood-based materials | | Raw material – EU Timber regulation | EUTR | | • |
| Wooden elements lacquering | | Water lacquer UV | UV | | • |
| | | Water lacquer | | | - 20 |
| Assembly | | Assembled | ASM-F | | • |
| Sample order | PINTA TABLE SQ (W600 D600 H450 FSP MP/MP BC-SV/SKNB GD EUTR UV ASM-F) | | | | |

* x/y mm – x: overall height/y: height under table top

① – Please specify table top colour code/solid wood colour code – [see finishes](#)

② – Please specify table top edge finish – [see finishes](#)

- Available as standard (included in basic price).
- Available as an option (included in basic price).

Price list

Pinta table RC

Rectangular table top.
25 mm table top thickness for Melamine (MFC) finish.
27 mm table top thickness for Laminate finish.
Base – square wooden legs.



PINTA TABLE RC

| | | H (mm) | 740/715* Melamine (MFC) 742 / 715* Laminate |
|--------------------------------------|--|-----------------------------------|--|
| | | WT (kg) | 16,15 |
| Width (mm) | W... | | 900 |
| Depth (mm) | D... | | 600 |
| | | | Basic price (EUR) according to table top finishes |
| Melamine (MFC) | | | 338 |
| Laminate | | | 489 |
| Height | 450 mm (448 mm for Melamine MFC, 450 mm for Laminate) | H450 | • |
| | 500 mm (498 mm for Melamine MFC, 500 mm for Laminate) | H500 | ◦ |
| Table top board core | Chipboard | FSP | • |
| Table top finish | Melamine (MFC) | Edge: 2 mm glue technology ①/② | • |
| | Laminate | | • |
| Base finish | Metal plate: powder-coated in Silver 98 colour Solid wood: Natural beech Stained beech | BC-SV/① | • |
| | | | 13 |
| Glides | Plastic glides | GD | • |
| | Plastic glides with felt | GDF | ◦ |
| Wood and wood-based materials | Raw material – EU Timber regulation | EUTR | • |
| Wooden elements lacquering | Water lacquer UV | UV | • |
| | Water lacquer | | -20 |
| Assembly | Assembled | ASM-F | • |
| Sample order | PINTA TABLE RC (W900 D600 H450 FSP MP/MP BC-SV/SKNB GD EUTR UV ASM-F) | | |

* x/y mm – x: overall height/y: height under table top

① – Please specify table top colour code/solid wood colour code – [see finishes](#)

② – Please specify table top edge finish – [see finishes](#)

- Available as standard (included in basic price).
- Available as an option (included in basic price).

Materials, finishes

Wood

Natural



SKNB
Natural
Beech

Stained



2.07Y
Black



2.06S
Slate



S39
Light Grey



2.09S
White



2.0CB
Acacia



SK40
Oak



2.0CC
Walnut

Melamine (MFC)



CW
Black
Graphite



MG
Grey Vicenza
Oak

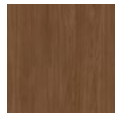

LW
Lincoln
Walnut

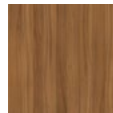

NW
Natural Dijon
Walnut



NZ
Natural
Hickory



HO
Hamilton Oak



ML
Kaisersberg
Oak



NJ
Acacia Light



NH
Maple



MM
Ellmau
Beech



CC
Black



MS
Slate



MP
Platinum



MB
White Grey



NK
Cashmere



BA
Truffle Grey



ST
Smoke Blue

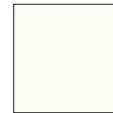

BI
White

Laminate

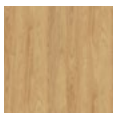

HZ
Natural
Hickory



KU
Hamilton Oak

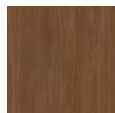

KT
Lincoln
Walnut



GN
Acacia Light



HE
Kaisersberg
Oak



FC
Grey Vicenza
Oak



HF
Ellmau
Beech



DD
Black



GW
Slate



BW
Platinum



CA
White



FN
White Grey



HC
Cashmere



AA
Came Beige

Edge

HPL Laminate



2 mm
plastic



2 mm
plastic with
protective
edge

Metal



Silver 98
SV

General notes

All specified dimensions are approximate. Subject to minor modifications or differences for reasons of design improvements or for technical reasons.

- W = width
- D = depth
- H = height
- DI = diameter
- SH = seat height
- SH DIN = seat height measured acc. to DIN EN 1335-1
- WT = weight

In compliance with the highest quality standards "Quality is irreplaceable." Guided by this principle, each product line is subjected to stringent quality testing.

Warranty

Manufacturer declares that the products shall be free from defects in material or workmanship. The warranty is given to the original purchaser only, for normal commercial usage. Detailed terms of warranty and warranty periods are available at <https://www.kusch.com/en/warranty>

¡hola!
tables
price list
2026

¡hola!

Design by Kusch + Co Designteam

Meeting table



HOLA MEETING TABLE LGM SQ



HOLA MEETING TABLE LGM RC



HOLA MEETING TABLE LGM RD

Table



HOLA TABLE LGM SQ



HOLA TABLE LGM RC

Price list

¡hola! meeting table LGM SQ

Square table top.
25 mm table top thickness for Melamine (MFC) finish.
27 mm table top thickness for Laminate and Fenix finish.
Base – metal legs.



HOLA MEETING TABLE LGM SQ

| | | WT (kg) | 14,9 | 17,3 | 20,2 | 23,4 | 25,20 | |
|-------------------------------|--|--|-----------------|--------|------|------|-------|--|
| Width (mm) | W... | 600 | 700 | 800 | 900 | 1000 | | |
| Depth (mm) | D... | 600 | 700 | 800 | 900 | 1000 | | |
| | | Basic price (EUR) according to table top finishes | | | | | | |
| Melamine (MFC) | | 231 | 237 | 252 | 263 | 276 | | |
| Laminate | | 336 | 345 | 365 | 383 | 403 | | |
| Fenix NTM® | | 405 | 424 | 509 | 582 | 666 | | |
| Height | Standard (735 mm for Melamine (MFC), 737 mm for Laminate and Fenix) | 710 mm height under table top | H737 | | | | • | |
| | Elevated (785 mm for Melamine (MFC), 787 mm for Laminate and Fenix) | 760 mm height under table top | H787 | | | | ◦ | |
| Table top core | Chipboard | FSP | | | | | • | |
| Table top finish | Melamine (MFC) | Edge: 2 mm glue technology | ①/② | | | | • | |
| | | Protective edge: 2 mm glue technology | ①/②-PE | | | 85 | | |
| | Laminate | Edge: 2 mm glue technology | ①/② | | | | • | |
| | | Protective edge: 2 mm glue technology | ①/②-PE | | | 85 | | |
| Fenix NTM® | Edge: 1 mm laser edge (matching table top colour) | ① | | | | • | | |
| Base finish | Metal plates: matching legs finish | Legs | | | | | • | |
| | | powder-coated | | | | | • | |
| | | Steel | chromium plated | BC-③/③ | | | 20 | |
| | | satin chrome | | | | 36 | | |
| Table top connectors | None | | | | | | • | |
| | Plastic connectors | TC | | | | 52 | | |
| Wood and wood-based materials | Raw material - EU Timber regulation | EUTR | | | | | • | |
| Assembly | Partially Assembled | ASM-P | | | | | • | |
| | Assembled | ASM-F | | | | | • | |

Sample order HOLA MEETING TABLE LGM SQ (W600 D600 H737 FSP KNB BC-BL/BL EUTR ASM-P)

① – Please specify table top colour code/solid wood colour code: [see finishes](#)

② – Please specify table top edge finish: [see finishes](#)

③ – Please specify metal colour code: [see finishes](#)

- Available as standard (included in basic price)
- Available as an option (included in basic price)

Price list

¡hola! meeting table LGM RC

Rectangular table top.
25 mm table top thickness for Melamine (MFC) finish.
27 mm table top thickness for Laminate and Fenix finish.
Base – metal legs.



HOLA MEETING TABLE LGM RC

| WT (kg) | | 171 | 16,8 | 21,7 | 19,7 | 24,0 | 26,6 | 28,1 | 29,50 | 26,2 | 29,3 | 34,8 | 37,9 | 39,0 |
|-------------------------------|--|--|--------|------|------|------|------|------|-------|------|------|------|------|------|
| Width (mm) | W... | 800 | 900 | 1200 | 1000 | 1200 | 1400 | 1500 | 1500 | 1200 | 1400 | 1600 | 1800 | 1800 |
| Depth (mm) | D... | 600 | 600 | 600 | 700 | 700 | 700 | 700 | 750 | 800 | 800 | 800 | 800 | 900 |
| | | Basic price (EUR) according to table top finishes | | | | | | | | | | | | |
| Melamine (MFC) | | 238 | 243 | 257 | 247 | 263 | 279 | 314 | 325 | 275 | 288 | 348 | 353 | 358 |
| Laminate | | 346 | 351 | 375 | 360 | 383 | 406 | 458 | 473 | 401 | 419 | 508 | 513 | 521 |
| Fenix NTM® | | 433 | 448 | 513 | 545 | 552 | 559 | 613 | 634 | 582 | 588 | 812 | 822 | 832 |
| Height | Standard (735 mm for Melamine (MFC), 737 mm for Laminate and Fenix) | 710 mm height under table top | H737 | | | | | | | | | | | |
| | Elevated (785 mm for Melamine (MFC), 787 mm for Laminate and Fenix) | 760 mm height under table top | H787 | | | | | | | | | | | |
| Table top core | Chipboard | FSP | | | | | | | | | | | | |
| Table top finish | Melamine (MFC) | Edge: 2 mm glue technology | ①/② | | | | | | | | | | | |
| | | Protective edge: 2 mm glue technology | ①/②-PE | | | | | | | | | | | |
| | Laminate | Edge: 2 mm glue technology | ①/② | | | | | | | | | | | |
| | | Protective edge: 2 mm glue technology | ①/②-PE | | | | | | | | | | | |
| Fenix NTM® | Edge: 1 mm laser edge (matching table top colour) | ① | | | | | | | | | | | | |
| Base finish | Metal plates: matching legs finish | Legs | | | | | | | | | | | | |
| | | powder-coated | | | | | | | | | | | | |
| | | Steel chromium plated | BC-③/③ | | | | | | | | | | | |
| | | satin chrome | | | | | | | | | | | | |
| Table top connectors | None | | | | | | | | | | | | | |
| | Plastic connectors | TC | | | | | | | | | | | | |
| Wood and wood-based materials | Raw material - EU Timber regulation | EUTR | | | | | | | | | | | | |
| Assembly | Partially Assembled | ASM-P | | | | | | | | | | | | |
| | Assembled | ASM-F | | | | | | | | | | | | |

Sample order HOLA MEETING TABLE LGM RC (W800 D600 H737 FSP KNB BC-BL/BL EUTR ASM-P)

① – Please specify table top colour code/ solid wood colour code: [see finishes](#)

② – Please specify table top edge finish: [see finishes](#)

③ – Please specify metal colour code: [see finishes](#)

- Available as standard (included in basic price)
- Available as an option (included in basic price)

¡hola! meeting table LGM RD

Round table top.
25 mm table top thickness for Melamine (MFC) finish.
27 mm table top thickness for Laminate and Fenix finish.
Base – metal legs.



HOLA MEETING TABLE LGM RD

| WT (kg) | 15,3 | 17,6 | 20,0 | 23,0 | 29,5 | 41,6 |
|---------|------|------|------|------|------|------|
|---------|------|------|------|------|------|------|

| Diameter (mm) | D... | 700 | 800 | 900 | 1000 | 1200 | 1500 |
|----------------|------|--|-----|-----|------|------|------|
| | | Basic price (EUR) according to table top finishes | | | | | |
| Melamine (MFC) | | 245 | 261 | 307 | 332 | 343 | 622 |
| Laminate | | 357 | 379 | 448 | 483 | 500 | – |
| Fenix NTM® | | 438 | 539 | 649 | 677 | 771 | 1333 |

| | | | | | | | |
|--------------------------------------|--|---|----------------------|--------|--|----|----|
| Height | Standard (735 mm for Melamine (MFC), 737 mm for Laminate and Fenix) | 710 mm height under table top | H737 | | | | • |
| | Elevated (785 mm for Melamine (MFC), 787 mm for Laminate and Fenix) | 760 mm height under table top | H787 | | | | ◦ |
| Table top core | Chipboard | | FSP | | | | • |
| Table top finish | Melamine (MFC) | Edge: | 2 mm glue technology | ①/② | | | • |
| | | Protective edge: | 2 mm glue technology | ①/②-PE | | | 85 |
| | Laminate | Edge: | 2 mm glue technology | ①/② | | | • |
| | | Protective edge: | 2 mm glue technology | ①/②-PE | | | 85 |
| Fenix NTM® | Edge: | 1 mm laser edge (matching table top colour) | ① | | | • | |
| Base finish | Metal plates: matching legs finish | Legs | | | | | |
| | | | powder-coated | | | | • |
| | | Steel | black chrome | BC-③/③ | | | 31 |
| | | satin chrome | | | | 36 | |
| Wood and wood-based materials | Raw material - EU Timber regulation | | EUTR | | | | • |
| Assembly | Partially Assembled | | ASM-P | | | | • |
| | Assembled | | ASM-F | | | | • |

Sample order HOLA MEETING TABLE LGM RD (DI700 H737 FSP KNB BC-BL/BL EUTR ASM-P)

① – Please specify table top colour code/solid wood colour code: [see finishes](#)

② – Please specify table top edge finish: [see finishes](#)

③ – Please specify metal colour code: [see finishes](#)

- Available as standard (included in basic price)
- Available as an option (included in basic price)

Price list

¡hola! table LGM SQ

Square table top.
25 mm table top thickness for Melamine (MFC) finish.
27 mm table top thickness for Laminate and Fenix finish.
Base – metal legs.



HOLA TABLE LGM SQ

| | | | | |
|--|--|--|-----------------|--------|
| H (mm) | 735 – Melamine (MFC) 737 – Laminate and Fenix (448 mm or 498 mm Melamine (MFC), 450 mm or 500 mm for Laminate, Fenix) | | | |
| WT (kg) | 12,03 | | | |
| Width (mm) | W••• | 600 | | |
| Depth (mm) | D••• | 600 | | |
| Basic price (EUR) according to table top finishes | | | | |
| Melamine (MFC) | | | 208 | |
| Laminate | | | 303 | |
| Fenix NTM® | | | 365 | |
| Height | 450 mm (448 mm for Melamine MFC, 450 mm for Laminate, Fenix) | H450 | • | |
| | 500 mm (498 mm for Melamine MFC, 500 mm for Laminate, Fenix) | H500 | ◦ | |
| Table top core | Chipboard | FSP | • | |
| Table top finish | Melamine (MFC) | Edge: 2 mm glue technology | ①/② | |
| | Laminate | | | |
| | Fenix NTM® | Edge: 1 mm laser edge (matching table top colour) | ① | |
| Base finish | Metal plates: matching legs finish | Steel | Legs | |
| | | | powder-coated | BC-③/③ |
| | | | chromium plated | |
| | | | satin chrome | |
| Glides | Protect | GD | • | |
| | Plastic with felt | GDF | ◦ | |
| Wood and wood-based materials | Raw material - EU Timber regulation | EUTR | • | |
| Assembly | Partially Assembled | ASM-P | • | |
| | Assembled | ASM-F | • | |

Sample order HOLA TABLE LGM SQ (W600 D600 H450 FSP KJ BC-BL/BL GD EUTR ASM-P)

① – Please specify table top colour code/solid wood colour code: [see finishes](#)

② – Please specify table top edge finish: [see finishes](#)

③ – Please specify metal colour code: [see finishes](#)

• Available as standard (included in basic price)

◦ Available as an option (included in basic price)

¡hola! table LGM RC

Rectangular table top.
25 mm table top thickness for Melamine (MFC) finish.
27 mm table top thickness for Laminate and Fenix finish.
Base – metal legs.



HOLA TABLE LGM SQ

| | |
|---------|--|
| H (mm) | 735 – Melamine (MFC) 737 – Laminate and Fenix (448 mm or 498 mm Melamine (MFC), 450 mm or 500 mm for Laminate, Fenix) |
| WT (kg) | 15,31 |

| | | |
|----------------|------|--|
| Width (mm) | W... | 900 |
| Depth (mm) | D... | 600 |
| | | Basic price (EUR) according to table top finishes |
| Melamine (MFC) | | 219 |
| Laminate | | 316 |
| Fenix NTM® | | 404 |

| | | | | |
|--------------------------------------|--|--|-----------------|----|
| Height | 450 mm (448 mm for Melamine MFC, 450 mm for Laminate, Fenix) | H450 | • | |
| | 500 mm (498 mm for Melamine MFC, 500 mm for Laminate, Fenix) | H500 | ◦ | |
| Table top core | Chipboard | FSP | • | |
| Table top finish | Melamine (MFC) | | | |
| | Laminate | Edge: 2 mm glue technology | ①/② | |
| | Fenix NTM® | Edge: 1 mm laser edge (matching table top colour) | ① | |
| Base finish | Legs | | | |
| | Metal plates: matching legs finish | Steel | powder-coated | • |
| | | | chromium plated | 20 |
| | | | satin chrome | 36 |
| Glides | Protect | GD | • | |
| | Plastic with felt | GDF | ◦ | |
| Wood and wood-based materials | Raw material - EU Timber regulation | EUTR | • | |
| Assembly | Partially Assembled | ASM-P | • | |
| | Assembled | ASM-F | • | |

Sample order HOLA TABLE LGM RC (W900 D600 H450 FSP KJ BC-BL/BL GD EUTR ASM-P)

① – Please specify table top colour code/solid wood colour code: [see finishes](#)

② – Please specify table top edge finish: [see finishes](#)

③ – Please specify metal colour code: [see finishes](#)

- Available as standard (included in basic price)
- Available as an option (included in basic price)

Materials, finishes

Melamine (MFC)



Laminate



Fenix NTM®

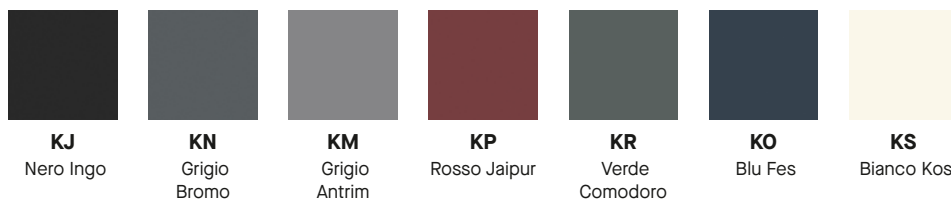

Edge

HPL Laminate



2 mm
plastic



2 mm
plastic with
protective
edge

Fenix NTM®



1 mm
laser

Materials, finishes

Metal



**NCS S
2005-Y60R**
Cashmere
NK



RAL 1024
Ochre Yellow
OY



**RAL 030
50 40**
Vermilion
Red
VR



RAL 6003
Olive Green
OG



RAL 5000
Violet Blue
VB



Chrome
CR



**Satin
Chrome**
SCR



RAL 9003
Signal White
WS



Silk
KSK



RAL 9006
White
Aluminium
WK



Silver 98
SV



DB 703
Iron Mica
IM



RAL 9005
Jet Black
BK, BL

General notes

All specified dimensions are approximate. Subject to minor modifications or differences for reasons of design improvements or for technical reasons.

- W = width
- D = depth
- H = height
- DI = diameter
- SH = seat height
- SH DIN = seat height measured acc. to DIN EN 1335-1
- WT = weight

In compliance with the highest quality standards "Quality is irreplaceable." Guided by this principle, each product line is subjected to stringent quality testing.

Warranty

Manufacturer declares that the products shall be free from defects in material or workmanship. The warranty is given to the original purchaser only, for normal commercial usage. Detailed terms of warranty and warranty periods are available at <https://www.kusch.com/en/warranty>

embla
tables
price list
2026

Embla

Design by Antonio Scaffidi

Meeting table

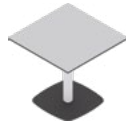

EMBLA MEETING TABLE SQ

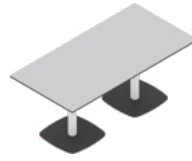

EMBLA MEETING TABLE RC



EMBLA MEETING TABLE SQR

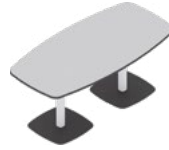

EMBLA MEETING TABLE RCR



EMBLA MEETING TABLE RD

Price list

Embla meeting table SQ

Square table top.
25 mm table top thickness for melamine (MFC) finish.
27 mm table top thickness for Laminate and Fenix finish.
Base – column made of solid beech wood, metal base plate, powder-coated.

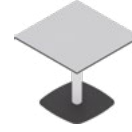

EMBLA MEETING TABLE SQ

| | | 740 Melamine (MFC) 742 Laminate and Fenix | | | | |
|---|-------------------------------------|---|---------------------------------|-----------|-----------|-----------|
| H (mm) | | | | | | |
| WT (kg) | | 25,7 | 28,1 | 29,4 | 36,6 | 39,6 |
| Base dimension (mm) | | 450 x 450 | 450 x 450 | 450 x 450 | 550 x 550 | 550 x 550 |
| Width (mm) | W... | 600 | 700 | 750 | 800 | 900 |
| Depth (mm) | D... | 600 | 700 | 750 | 800 | 900 |
| | | Basic price (EUR) according to table top finishes | | | | |
| Laminate | | 369 | 379 | 386 | 445 | 454 |
| Fenix NTM® | | 437 | 470 | 474 | 567 | 582 |
| Melamine (MFC) | | 273 | 280 | 286 | 329 | 336 |
| Table top core | Chipboard | FSP | | | | • |
| | Medium density fibreboard (MDF) | MDF | | | | 331 |
| Table top finish for chipboard (FSP) | Laminate | Edge: 2 mm glue technology | ①/② | | | • |
| | | Protective edge: 2 mm glue technology | ①/②-PE | | | 85 |
| | Fenix NTM® | Edge: 1 mm in glue technology (matching table top colour) | ① | | | • |
| | Melamine (MFC) | Edge: 2 mm glue technology | ①/② | | | • |
| Protective edge: 2 mm glue technology | | ①/②-PE | | | 85 | |
| Table top finish for medium density fibreboard (MDF) | Laminate | 2 mm glue technology | ①/②-CE | | | • |
| | Fenix NTM® | Chamfered edge: 1 mm in glue technology (matching table top colour) | ①-CE | | | • |
| Base finish | Column | Natural beech | Base plate: powder-coated steel | BC-①/③ | | • |
| | | Stained beech | | | | 13 |
| Wood and wood-based materials | Raw material – EU Timber regulation | EUTR | | | | • |
| Wooden elements lacquering | Water lacquer UV | UV | | | | • |
| | Water lacquer | | | | | -40 |
| Assembly | Partially Assembled | ASM-P | | | | • |
| | Assembled | ASM-F | | | | 10 |

Sample order EMBLA MEETING TABLE SQ (W600 D600 FSP H740 BC-SKNB/BL EUTR UV ASM-F)

* x/y mm – x: overall height/y: height under table top

① – Please specify table top colour code/solid wood colour code – [see finishes](#)

② – Please specify table top edge finish – [see finishes](#)

③ – Please specify metal colour code – [see finishes](#)

• Available as standard (included in basic price)

Price list

Embla meeting table RC

Rectangular table top.
25 mm table top thickness for melamine (MFC) finish.
27 mm table top thickness for Laminate and Fenix finish.
Base – wo columns made of solid beech wood, metal base plates, powder-coated.

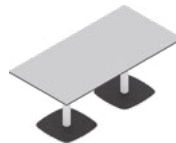

EMBLA MEETING TABLE RC

| | | 740 Melamine (MFC) 742 Laminate and Fenix | | | | | |
|---|-------------------------------------|---|---------------------------------|-----------|-----------|-----------|-----------|
| H (mm) | | | | | | | |
| WT (kg) | | 67,4 | 67,8 | 70,3 | 73,2 | 76,0 | 79,3 |
| Base dimension (mm) | | 550 × 550 | 450 × 450 | 550 × 550 | 550 × 550 | 550 × 550 | 550 × 550 |
| Width (mm) | W... | 1200 | 1400 | 1400 | 1600 | 1600 | 1800 |
| Depth (mm) | D... | 800 | 700 | 800 | 800 | 900 | 900 |
| | | Basic price (EUR) according to table top finishes | | | | | |
| Laminate | | 854 | 871 | 886 | 898 | 901 | 906 |
| Fenix NTM® | | 886 | 897 | 903 | 1059 | 1064 | 1119 |
| Melamine (MFC) | | 632 | 645 | 656 | 665 | 667 | 670 |
| Table top core | Chipboard | FSP | | | | | • |
| | Medium density fibreboard (MDF) | MDF | | | | | 331 |
| Table top finish for chipboard (FSP) | Laminate | Edge: 2 mm glue technology | ①/② | | | | • |
| | | Protective edge: 2 mm glue technology | ①/②-PE | | | | 85 |
| | Fenix NTM® | Edge: 1 mm in glue technology (matching table top colour) | ① | | | | • |
| | Melamine (MFC) | Edge: 2 mm glue technology | ①/② | | | | • |
| Protective edge: 2 mm glue technology | | ①/②-PE | | | | 85 | |
| Table top finish for medium density fibreboard (MDF) | Laminate | 2 mm glue technology | ①/②-CE | | | | • |
| | Fenix NTM® | Chamfered edge: 1 mm in glue technology (matching table top colour) | ①-CE | | | | • |
| Base finish | Column | Natural beech | Base plate: powder-coated steel | BC-①/③ | | | • |
| | | Stained beech | | | | | 25 |
| Wood and wood-based materials | Raw material – EU Timber regulation | EUTR | | | | | • |
| Wooden elements lacquering | Water lacquer UV | UV | | | | | • |
| | Water lacquer | | | | | | - 40 |
| Assembly | Partially Assembled | ASM-P | | | | | • |
| | Assembled | ASM-F | | | | | 10 |

Sample order EMBLA MEETING TABLE RC (W1200 D800 FSP H740 BC-SKNB/BL EUTR UV ASM-F)

* x/y mm – x: overall height/y: height under table top

① – Please specify table top colour code/solid wood colour code – [see finishes](#)

② – Please specify table top edge finish – [see finishes](#)

③ – Please specify metal colour code – [see finishes](#)

• Available as standard (included in basic price)

Embla meeting table SQR

Soft square table top with rounded edges,
25 mm table top thickness for melamine (MFC) finish.
27 mm table top thickness for Laminate and Fenix finish.
Base – column made of solid beech wood,
metal base plate, powder-coated.



EMBLA MEETING TABLE SQR

| H (mm) | 740 Melamine (MFC) 742 Laminate and Fenix | | |
|---------------------|--|-----------|-----------|
| WT (kg) | 25,7 | 36,6 | 39,6 |
| Base dimension (mm) | 450 × 450 | 550 × 550 | 550 × 550 |

| | | | | |
|--|------|-----|-----|-----|
| Width (mm) | W... | 700 | 800 | 900 |
| Depth (mm) | D... | 700 | 800 | 900 |
| Basic price (EUR) according to table top finishes | | | | |
| Laminate | | 405 | 475 | 533 |
| Fenix NTM® | | 477 | 580 | 652 |
| Melamine (MFC) | | 300 | 357 | 438 |

| | | | | | |
|---|-------------------------------------|----------------------|---|--------|-----|
| Table top core | Chipboard | | FSP | | • |
| | Medium density fibreboard (MDF) | | MDF | | 331 |
| Table top finish for chipboard (FSP) | Laminate | Edge: | 2 mm glue technology | ①/② | • |
| | | Protective edge: | 2 mm glue technology | ①/②-PE | 85 |
| | Fenix NTM® | Edge: | 1 mm in glue technology (matching table top colour) | ① | • |
| | Melamine (MFC) | Edge: | 2 mm glue technology | ①/② | • |
| Protective edge: | | 2 mm glue technology | ①/②-PE | 85 | |
| Table top finish for medium density fibreboard (MDF) | Laminate | | 2 mm glue technology | ①/②-CE | • |
| | Fenix NTM® | Chamfered edge: | 1 mm in glue technology (matching table top colour) | ①-CE | • |
| Base finish | Column | Natural beech | Base plate: powder-coated steel | BC-①/③ | • |
| | | Stained beech | | | 13 |
| Wood and wood-based materials | Raw material – EU Timber regulation | | | EUTR | • |
| Wooden elements lacquering | Water lacquer UV | | | UV | • |
| | Water lacquer | | | | -40 |
| Assembly | Partially Assembled | | | ASM-P | • |
| | Assembled | | | ASM-F | 10 |

Sample order EMBLA MEETING TABLE SQR (W700 D700 FSP H740 BC-SKNB/BL EUTR UV ASM-F)

* x/y mm – x: overall height/y: height under table top

① – Please specify table top colour code/solid wood colour code – [see finishes](#)

② – Please specify table top edge finish – [see finishes](#)

③ – Please specify metal colour code – [see finishes](#)

• Available as standard (included in basic price)

Price list

Embla meeting table RCR

Soft rectangular table top with rounded edges,
25 mm table top thickness for melamine (MFC) finish.
27 mm table top thickness for Laminate and Fenix finish.
Base – two columns made of solid beech wood,
metal base plates, powder-coated.



EMBLA MEETING TABLE RCR

| | | 740 Melamine (MFC) 742 Laminate and Fenix | |
|--|---------------------------------|---|-----------|
| H (mm) | | | |
| WT (kg) | | 54,7 | 79,6 |
| Base dimension (mm) | | 450 × 450 | 550 × 550 |
| Basic price (EUR) according to table top finishes | | | |
| Laminate | | 751 | 899 |
| Fenix NTM® | | 882 | 1068 |
| Melamine (MFC) | | 539 | 654 |
| Width (mm) | W... | 1400 | 1800 |
| Depth (mm) | D... | 700 | 900 |
| Table top core | | | |
| | Chipboard | FSP | • |
| | Medium density fibreboard (MDF) | MDF | 331 |
| Table top finish for chipboard (FSP) | | | |
| Laminate | Edge: | 2 mm glue technology | ①/② |
| | Protective edge: | 2 mm glue technology | ①/②-PE |
| Fenix NTM® | Edge: | 1 mm in glue technology (matching table top colour) | ① |
| Melamine (MFC) | Edge: | 2 mm glue technology | ①/② |
| | Protective edge: | 2 mm glue technology | ①/②-PE |
| Table top finish for medium density fibreboard (MDF) | | | |
| Laminate | | 2 mm glue technology | ①/②-CE |
| Fenix NTM® | Chamfered edge: | 1 mm in glue technology (matching table top colour) | ①-CE |
| Base finish | | | |
| Column | Natural beech | Base plate: powder-coated steel | BC-①/③ |
| | Stained beech | | |
| Wood and wood-based materials | | | |
| Raw material – EU Timber regulation | | EUTR | • |
| Wooden elements lacquering | | | |
| Water lacquer UV | | UV | • |
| Water lacquer | | | - 40 |
| Assembly | | | |
| Partially Assembled | | ASM-P | • |
| Assembled | | ASM-F | 10 |

Sample order EMBLA MEETING TABLE RCR (W1400 D700 FSP H740 BC-SKNB/BL EUTR UV ASM-F)

* x/y mm – x: overall height/y: height under table top

① – Please specify table top colour code/solid wood colour code – [see finishes](#)

② – Please specify table top edge finish – [see finishes](#)

③ – Please specify metal colour code – [see finishes](#)

• Available as standard (included in basic price)

○ Available as an option (included in basic price)

Embla meeting table RD

Round table top.
25 mm table top thickness for melamine (MFC) finish.
27 mm table top thickness for Laminate and Fenix finish.
Base – column made of solid beech wood,
metal base plate, powder-coated.



EMBLA MEETING TABLE RD

| | | 740 Melamine (MFC) 742 Laminate and Fenix | | | |
|---|-------------------------------------|---|---------------------------------|-----------|-----|
| H (mm) | | | | | |
| WT (kg) | | 26,2 | 34,1 | 36,5 | |
| Base dimension (mm) | | 450 × 450 | 550 × 550 | 550 × 550 | |
| Diameter (mm) | | DI... | 700 | 800 | 900 |
| | | Basic price (EUR) according to table top finishes | | | |
| Laminate | | 427 | 464 | 519 | |
| Fenix NTM® | | 458 | 549 | 611 | |
| Melamine (MFC) | | 316 | 347 | 405 | |
| Table top core | Chipboard | FSP | | • | |
| | Medium density fibreboard (MDF) | MDF | | 331 | |
| Table top finish for chipboard (FSP) | Laminate | Edge: 2 mm glue technology | ①/② | • | |
| | | Protective edge: 2 mm glue technology | ①/②-PE | 85 | |
| | Melamine (MFC) | Edge: 1 mm in glue technology (matching table top colour) | ① | • | |
| | | Edge: 2 mm glue technology | ①/② | • | |
| Table top finish for medium density fibreboard (MDF) | Laminate | Protective edge: 2 mm glue technology | ①/②-PE | 85 | |
| | | Chamfered edge: 2 mm glue technology | ①/②-CE | • | |
| Base finish | Column | Natural beech | Base plate: powder-coated steel | BC-①/③ | |
| | | Stained beech | | | • |
| Wood and wood-based materials | Raw material – EU Timber regulation | EUTR | | 13 | |
| Wooden elements lacquering | Water lacquer UV | UV | | • | |
| | Water lacquer | | | -40 | |
| Assembly | Partially Assembled | ASM-P | | • | |
| | Assembled | ASM-F | | 10 | |

Sample order EMBLA MEETING TABLE RD (DI700 FSP H740 BC-SKNB/BL EUTR UV ASM-F)

* x/y mm – x: overall height/y: height under table top

① – Please specify table top colour code/solid wood colour code – [see finishes](#)

② – Please specify table top edge finish – [see finishes](#)

③ – Please specify metal colour code – [see finishes](#)

• Available as standard (included in basic price)

○ Available as an option (included in basic price)

Materials, finishes

Wood

Natural



SKNB
Natural
Beech

Stained



2.07Y
Black



2.06S
Slate



S39
Light Grey



2.09S
White



2.0CB
Acacia



SK40
Oak



2.0CC
Walnut

Melamine



CW
Black Graphite



MG
Grey Vicenza
Oak



LW
Lincoln
Walnut



NW
Natural Dijon
Walnut



NZ
Natural
Hickory



HO
Hamilton Oak



ML
Kaisersberg
Oak



NJ
Acacia Light



NH
Maple



MM
Ellmau
Beech



CC
Black



MS
Slate



MP
Platinum

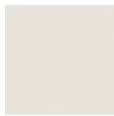

MB
White Grey



NK
Cashmere

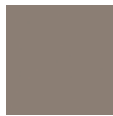

BA
Truffle Grey



ST
Smoke Blue



BI
White

Laminate

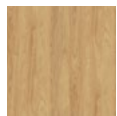

HZ
Natural
Hickory

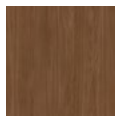

KT
Lincoln
Walnut



GN
Acacia Light



HE
Kaisersberg
Oak



FC
Grey Vicenza
Oak



HF
Ellmau
Beech



GW
Slate



BW
Platinum



CA
White

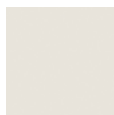

FN
White Grey



HC
Cashmere

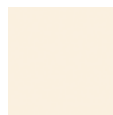

AA
Came Beige

Fenix NTM®



KJ
Nero Ingo



KN
Grigio Bromo



KM
Grigio Antrim



KP
Rosso Jaipur



KR
Verde Comodoro



KO
Blu Fes

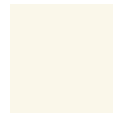

KS
Bianco Kos

Edge

Laminate



2 mm
plastic

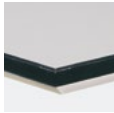

2 mm
plastic on
MDF,
50 mm
chamfered
lipping



2 mm
plastic with
protective
edge

Fenix NTM®



1 mm
plastic PP

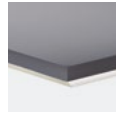

1 mm
plastic PP on
MDF,
50 mm
chamfered
lipping

Melamine (MFC)



2 mm
plastic



2 mm
plastic with
protective
edge

Metal



**NCS S
2005-
Y60R**
Cashmere
NK



RAL 1024
Ochre Yellow
OY



**RAL 030
50 40**
Vermilion
Red
VR



RAL 6003
Olive Green
OG



RAL 5000
Violet Blue
VB



RAL 9016
Traffic White
WT



Silk
KSK



RAL 9006
White
Aluminium
WK



Silver 98
SV



DB 703
Iron Mica
IM



RAL 9005
Jet Black
BL

General notes

All specified dimensions are approximate. Subject to minor modifications or differences for reasons of design improvements or for technical reasons.

- W = width
- D = depth
- H = height
- DI = diameter
- SH = seat height
- SH DIN = seat height measured acc. to DIN EN 1335-1
- WT = weight

In compliance with the highest quality standards "Quality is irreplaceable." Guided by this principle, each product line is subjected to stringent quality testing.

Warranty

Manufacturer declares that the products shall be free from defects in material or workmanship. The warranty is given to the original purchaser only, for normal commercial usage.

Detailed terms of warranty and warranty periods are available at

<https://www.kusch.com/en/warranty>

scorpii
tables
price list
2026

Scorpii

Design: Uwe Sommerlade

Table

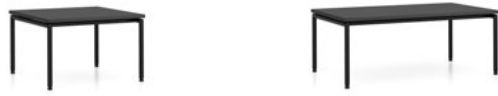

SCORPII TABLE RC

Price list

Scorpii table

Rectangular table top.
18 mm table top thickness for melamine (MFC) finish.
21 mm table top thickness for Laminate and Fenix finish.



SCORPII TABLE RC

| | | WT (kg) | 8,1 / 8,6* | 11,3 / 11,7* |
|--|--|----------|------------|--------------|
| Width (mm) | W... | | 550 | 900 |
| Depth (mm) | D... | | 550 | 550 |
| Basic price (EUR) according to table top finishes | | | | |
| Melamine (MFC) | | | 250 | 279 |
| Laminate | | | 370 | 400 |
| Fenix NTM® | | | 454 | 510 |
| Table top finish | Melamine (MFC) | | | • |
| | Laminate | ① | | ◦ |
| | Fenix NTM® | | | |
| Height | 350 mm Melamina (MFC) / 353 mm Laminate and Fenix | H350 | | • |
| | 450 mm Melamina (MFC) / 453 mm Laminate and Fenix | H450 | | 7 |
| Base finish | Powder-coated steel | BC-③ | | • |
| Glides | Self-levelling glides | GD | | • |
| | Self-levelling glides with felt | GDF | | ◦ |
| Assembly | Assembled, cardboard packaging | PACK-ASM | | • |
| Sample order | SCORPII TABLE RC (W550 D550 KN H350 BC-WT GD PACK-ASM) | | | |

* x / y kg - x: table weight, height 350 mm / y: table weight, height 450 mm

① - Please specify table top colour code / solid wood colour code – [see finishes](#)

③ - Please specify metal colour code – [see finishes](#)

- Available as standard (included in basic price)
- Available as an option (included in basic price)

Finishes

Melamina

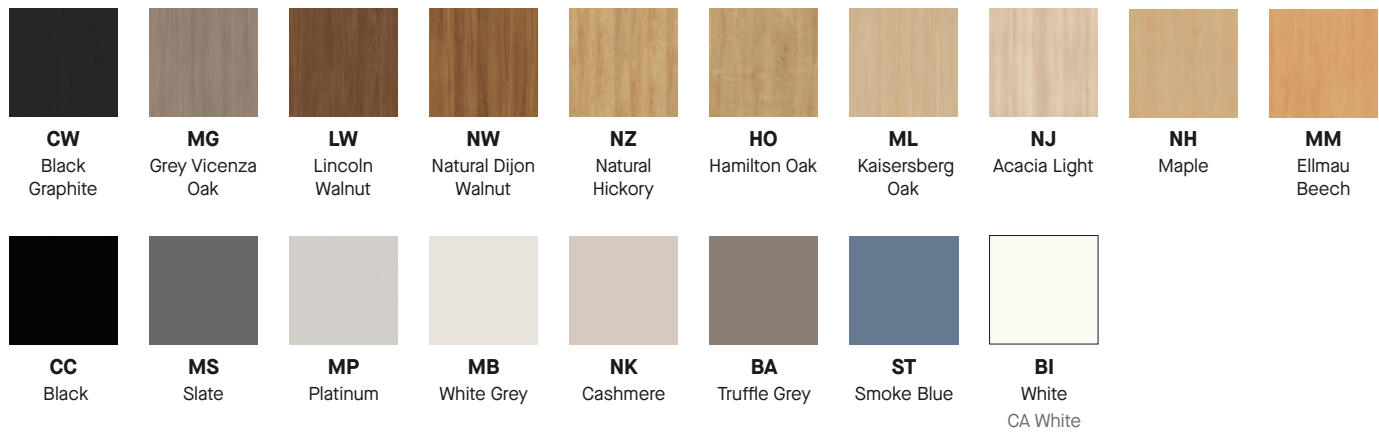

Laminate



Fenix NTM®

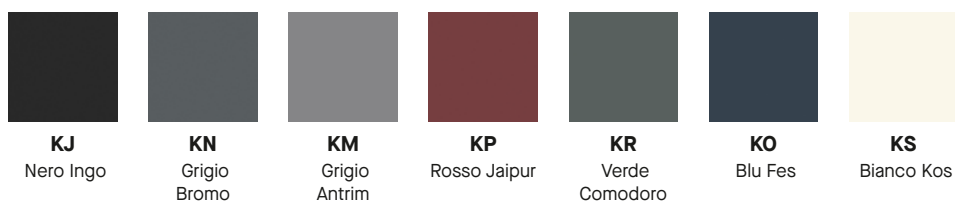

Metal



General notes

All specified dimensions are approximate. Subject to minor modifications or differences for reasons of design improvements or for technical reasons.

- W = width
- D = depth
- H = overall height
- DI = diameter
- SH = seat height
- SH DIN = seat height measured acc. to DIN EN 1335-1
- WT = weight

In compliance with the highest quality standards "Quality is irreplaceable." Guided by this principle, each product line is subjected to stringent quality testing.

Warranty

Manufacturer declares that the products shall be free from defects in material or workmanship. The warranty is given to the original purchaser only, for normal commercial usage. Detailed terms of warranty and warranty periods are available at <https://www.kusch.com/en/warranty>

arn
tables
price list
2026

Arn

Design: Scaffidi & Johansen

Meeting table



ARN MEETING TABLE LGW SQ



ARN MEETING TABLE LGW RC



ARN MEETING TABLE LGM SQ



ARN MEETING TABLE LGM RC



ARN MEETING TABLE LGW RD

Price list

Arn meeting table LGW SQ

Square table top, both sides rounded at 50 mm radius.
25 mm table top thickness for melamine (MFC) finish.
27 mm table top thickness for Laminate and Fenix finish.
Base – wooden legs.



ARN MEETING TABLE LGW SQ

| | | 741/711* Melamine (MFC) 743/711* Laminate and Fenix | | | | |
|---------------------------|---|--|-------------|---------------|---------|-----|
| | | 14,8 | 16,9 | 19,2 | 21,9 | |
| H (mm) | | | | | | |
| WT (kg) | | | | | | |
| Width (mm) | W... | 600 | 700 | 800 | 900 | |
| Depth (mm) | D... | 600 | 700 | 800 | 900 | |
| | | Basic price (EUR) according to table top finishes | | | | |
| Laminate | | 505 | 519 | 523 | 584 | |
| Fenix NTM® | | 559 | 577 | 648 | 766 | |
| Melamine (MFC) | | 376 | 387 | 390 | 435 | |
| Table top core | Chipboard | FSP | • | | | |
| | Laminate | Edge: 2 mm glue technology | ①/② | | • | |
| | | Protective edge: 2 mm glue technology | ①/②-PE | | 85 | |
| Table top finish | Fenix NTM® | Edge: 1 mm (matching table top colour) | ① | | • | |
| | Melamine (MFC) | Edge: 2 mm glue technology | ①/② | | • | |
| | | Protective edge: 2 mm glue technology | ①/②-PE | | 85 | |
| No grommets / media ports | | | • | | | |
| Media | Media port ALL IN 1M DI80 1× power socket 3× USB chargers (1× Type A, 2× Type C) 1× HDMI, 1× RJ45 | Position: central | White | ZA001-⑧-W | 135 | |
| | | | Black | ZA001-⑧-B | | |
| | Media port EVoline Circle80 1M 1× power socket 1× dual charger (Type A + C) | central | White | YR001-⑧-W | 110 | |
| | | | Black | YR001-⑧-B | | |
| Base finish | Fixing part: powder-coated steel | White Aluminium, RAL 9006 | Solid wood: | Natural beech | • | |
| | | | | Stained beech | BC-WK/① | 13 |
| | | | | Natural oak | | 105 |

* x/y mm – x: overall height/y: height under table top

① – Please specify table top colour code/solid wood colour code – [see finishes](#)

② – Please specify table top edge finish – [see finishes](#)

⑧ – Please specify media port standard: CH13, FR, GB, GE

• Available as standard (included in basic price)

○ Available as an option (included in basic price)

Price list

| | | | | | | ARN MEETING TABLE LGW SQ | | | | |
|--------------------------------------|---|----------------------------|----------------|-----------------|---------|--------------------------|-----|-----|----|--|
| | | Width (mm) | W•••• | 600 | 700 | 800 | 900 | | | |
| | | Depth (mm) | D•••• | 600 | 700 | 800 | 900 | | | |
| Cable management | None | | | | | | | • | | |
| | Vertical cable channel | Upholstered | Price group 4: | Blazer, Synergy | VC-U-⑤ | | | 31 | | |
| | | Flexible, plastic, modular | Colour : | White | VC-FM-W | | | | 61 | |
| | | | Black | VC-FM-B | | | | | | |
| Aluminium | VC-FM-AU | | | | | | | | | |
| Glides | Plastic glides | | | GD | | | | • | | |
| | Plastic glides with felt | | | GDF | | | | ○ | | |
| Table top connectors | No connector | | | | | | | • | | |
| | Plastic connector | | | TC | | | | 52 | | |
| Wood and wood-based materials | Raw material – EU Timber regulation | | | EUTR | | | | • | | |
| Wooden elements lacquering | Water lacquer UV | | | UV | | | | • | | |
| | Water lacquer | | | | | | | -40 | | |
| Assembly | Assembled | | | ASM-F | | | | • | | |
| Sample order | ARN MEETING TABLE LGW SQ (W800 D800 FSP CA/BI BC-SV/SKNO GDF EUTR UV ASM-F) | | | | | | | | | |

⑤ – Please specify upholstery colour code from selected price group – [see finishes](#)

- Available as standard (included in basic price)
- Available as an option (included in basic price)

Arn meeting table LGW RC

Rectangular table top, both sides rounded at 50 mm radius.
25 mm table top thickness for melamine (MFC) finish.
27 mm table top thickness for Laminate and Fenix finish.
Base – wooden legs.



ARN MEETING TABLE LGW RC

| H (mm) | | 741/711* Melamine (MFC) 743/711* Laminate and Fenix | | | | | | | | | | | |
|-------------------------|---|--|-------------|---------------|-----------|------|------|------|------|------|------|------|------|
| WT (kg) | | 16,7 | 17,7 | 20,5 | 20,2 | 22,4 | 24,3 | 26,7 | 24,3 | 28,9 | 31,9 | 34,4 | 37,2 |
| Width (mm) | | 800 | 900 | 1200 | 1000 | 1200 | 1400 | 1500 | 1200 | 1400 | 1600 | 1800 | 1800 |
| Depth (mm) | | 600 | 600 | 600 | 700 | 700 | 700 | 750 | 800 | 800 | 800 | 800 | 900 |
| | | Basic price (EUR) according to table top finishes | | | | | | | | | | | |
| Laminate | | 517 | 528 | 559 | 559 | 570 | 603 | 617 | 603 | 617 | 684 | 688 | 823 |
| Fenix NTM® | | 585 | 659 | 670 | 670 | 711 | 770 | 736 | 770 | 736 | 954 | 967 | 974 |
| Melamine (MFC) | | 386 | 394 | 417 | 417 | 425 | 449 | 459 | 449 | 459 | 510 | 513 | 613 |
| Table top core | Chipboard | FSP | | | | | | | | | | | |
| | Laminate | Edge: 2 mm glue technology | ①/② | | | | | | | | | | |
| Table top finish | Fenix NTM® | Protective edge: 2 mm glue technology | ①/②-PE | | | | | | | | | | |
| | | Edge: 1 mm (matching table top colour) | ① | | | | | | | | | | |
| | Melamine (MFC) | Edge: 2 mm glue technology | ①/② | | | | | | | | | | |
| | | Protective edge: 2 mm glue technology | ①/②-PE | | | | | | | | | | |
| Media | No grommets / media ports | | • | | | | | | | | | | |
| | Media port ALL IN 1M DI80 1 × gniazdo zasilające 3 × ładowarka USB (1 × typ A, 2 × typ C) 1 × HDMI, 1 × RJ45 | Position: central | Colour | White | ZA001-⑧-W | | | | | | | | |
| | | | Black | ZA001-⑧-B | | | | | | | | | |
| | | | White | YR001-⑧-W | | | | | | | | | |
| | | | Black | YR001-⑧-B | | | | | | | | | |
| Base finish | Fixing part: powder-coated steel | White Aluminium, RAL 9006 | Solid wood: | Natural beech | • | | | | | | | | |
| | | | | Stained beech | BC-WK/① | | | | | | | | |
| | | | | Natural oak | 105 | | | | | | | | |

* x/y mm – x: overall height/y: height under table top

① – Please specify table top colour code/solid wood colour code – see finishes

② – Please specify table top edge finish – see finishes

⑧ – Please specify media port standard: CH13, FR, GB, GE

• Available as standard (included in basic price)

○ Available as an option (included in basic price)

Price list

| | | ARN MEETING TABLE LGW RC | | | | | | | | | | | | | |
|--------------------------------------|--|----------------------------|----------------|-------|-----------------|--------------------|------|------|------|------|------|------|------|-----|--|
| Width (mm) | | 800 | 900 | 1200 | 1000 | 1200 | 1400 | 1500 | 1200 | 1400 | 1600 | 1800 | 1800 | | |
| Depth (mm) | | 600 | 600 | 600 | 700 | 700 | 700 | 750 | 800 | 800 | 800 | 800 | 900 | | |
| Cable management | None | | | | | | | | | | | | | • | |
| | Vertical cable channel | Upholstered | Price group 4: | | Blazer, Synergy | VC-U- ^⑤ | | | | | | | | 31 | |
| | | Flexible, plastic, modular | Colour : | White | VC-FM-W | | | | | | | | 61 | | |
| | | | | Black | VC-FM-B | | | | | | | | | | |
| | | Aluminium | VC-FM-AU | | | | | | | | | | | | |
| Glides | Plastic glides | | | | | | | | | | | | | • | |
| | Plastic glides with felt | | | | | | | | | | | | | ○ | |
| Table top connectors | No connector | | | | | | | | | | | | | • | |
| | Plastic connector | | | | | | | | | | | | | 52 | |
| Wood and wood-based materials | Raw material – EU Timber regulation | | | | | | | | | | | | | • | |
| Wooden elements lacquering | Water lacquer UV | | | | | | | | | | | | | • | |
| | Water lacquer | | | | | | | | | | | | | -40 | |
| Assembly | Assembled | | | | | | | | | | | | | • | |
| Sample order | ARN MEETING TABLE LGW RC (W1200 D800 FSP CA/BI BC-SV/SKNO GDF EUTR UV ASM-F) | | | | | | | | | | | | | | |

^⑤ – Please specify upholstery colour code from selected price group – [see finishes](#)

- Available as standard (included in basic price)
- Available as an option (included in basic price)

Arn meeting table LGM SQ

Square table top, both sides rounded at 50 mm radius.
25 mm table top thickness for melamine (MFC) finish.
27 mm table top thickness for Laminate and Fenix finish.
Base – aluminium legs.



ARN MEETING TABLE LGM SQ

| | | H (mm) | 741/711* Melamine (MFC) 743/711* Laminate and Fenix | | | |
|---------------------------|--|--|--|---------------|-----------|------|
| | | WT (kg) | 15,0 | 17,0 | 19,4 | 22,0 |
| Width (mm) | - | W... | 600 | 700 | 800 | 900 |
| Depth (mm) | - | D... | 600 | 700 | 800 | 900 |
| | | | Basic price (EUR) according to table top finishes | | | |
| Laminate | | | 478 | 506 | 525 | 553 |
| Fenix NTM® | | | 529 | 568 | 649 | 726 |
| Melamine (MFC) | | | 354 | 374 | 388 | 409 |
| Table top core | Chipboard | FSP | • | | | |
| | Laminate | Edge: 2 mm glue technology | ①/② | | • | |
| | | Protective edge: 2 mm glue technology | ①/②-PE | | 85 | |
| Table top finish | Fenix NTM® | Edge: 1 mm (matching table top colour) | ① | | • | |
| | Melamine (MFC) | Edge: 2 mm glue technology | ①/② | | • | |
| | | Protective edge: 2 mm glue technology | ①/②-PE | | 85 | |
| No grommets / media ports | | | • | | | |
| Media | Media port ALL IN 1M DI80 1 × gniazdo zasilające 3 × ładowarka USB (1 × typ A, 2 × typ C) 1 × HDMI, 1 × RJ45 | Position: central | Colour | White | ZA001-⑧-W | 135 |
| | | | | Black | ZA001-⑧-B | |
| | Media port EVoline Circle80 1M 1 × power socket 1 × dual charger (Type A + C) | Position: central | Colour | White | YR001-⑧-W | 110 |
| | | | | Black | YR001-⑧-B | |
| Base finish | Fixing part: powder-coated steel in legs colour | Legs: powder-coated aluminium | • | | | |
| | Fixing part: powder-coated steel | White aluminium, RAL 9006 | Anodised aluminium legs: | Silver matt | BC-③/③ | 13 |
| | | | | Silver bright | | |

* x/y mm – x: overall height/y: height under table top

① – Please specify table top colour code/solid wood colour code – [see finishes](#)

② – Please specify table top edge finish – [see finishes](#)

⑧ – Please specify media port standard: CH13, FR, GB, GE

• Available as standard (included in basic price)

○ Available as an option (included in basic price)

Price list

| | | | | | | ARN MEETING TABLE LGM SQ | | | |
|--------------------------------------|--|----------------------------|----------------|-----------------|---------|--------------------------|-----|-----|-----|
| Width (mm) | | | | | | 600 | 700 | 800 | 900 |
| Depth (mm) | | | | | | 600 | 700 | 800 | 900 |
| Cable management | None | | | | | • | | | |
| | Vertical cable channel | Upholstered | Price group 4: | Blazer, Synergy | VC-U-⑤ | 31 | | | |
| | | | | White | VC-FM-W | 61 | | | |
| | | Flexible, plastic, modular | Colour : | Black | VC-FM-B | | | | |
| | | | Aluminium | VC-FM-AU | | | | | |
| Glides | Plastic glides | | | | GD | • | | | |
| | Plastic glides with felt | | | | GDF | 11 | | | |
| Table top connectors | No connector | | | | | • | | | |
| | Plastic connector | | | | TC | 52 | | | |
| Wood and wood-based materials | Raw material – EU Timber regulation | | | | EUTR | • | | | |
| Assembly | Assembled | | | | ASM-F | • | | | |
| Sample order | ARN MEETING TABLE LGM SQ (W700 D700 FSP CA/BI BC-WK/ASAM GD TC EUTR ASM-F) | | | | | | | | |

⑤ – Please specify upholstery colour code from selected price group – [see finishes](#)

- Available as standard (included in basic price)
- Available as an option (included in basic price)

Arn meeting table LGM RC

Rectangular table top, both sides rounded at 50 mm radius.
25 mm table top thickness for melamine (MFC) finish.
27 mm table top thickness for Laminate and Fenix finish.
Base – aluminium legs.



ARN MEETING TABLE LGM RC

| H (mm) | | 741/711* Melamine (MFC) 743/711* Laminate and Fenix | | | | | | | | | | | |
|---|---|--|----------------------------------|---------------|-----------|------|------|------|------|------|------|------|------|
| WT (kg) | | 16,8 | 17,8 | 20,6 | 20,3 | 22,5 | 26,8 | 29,1 | 24,4 | 29,0 | 32,0 | 34,5 | 37,4 |
| Width (mm) | | 800 | 900 | 1200 | 1000 | 1200 | 1400 | 1500 | 1200 | 1400 | 1600 | 1800 | 1800 |
| Depth (mm) | | 600 | 600 | 600 | 700 | 700 | 700 | 750 | 800 | 800 | 800 | 800 | 900 |
| Basic price (EUR) according to table top finishes | | | | | | | | | | | | | |
| Laminate | | 491 | 501 | 529 | 529 | 540 | 571 | 576 | 571 | 576 | 640 | 690 | 828 |
| Fenix NTM® | | 554 | 624 | 635 | 635 | 673 | 729 | 690 | 729 | 690 | 896 | 968 | 981 |
| Melamine (MFC) | | 360 | 368 | 389 | 389 | 397 | 419 | 423 | 419 | 423 | 471 | 507 | 608 |
| Table top core | Chipboard | FSP | | | | | | • | | | | | |
| | Laminate | Edge: | 2 mm glue technology | ①/② | | • | | | | | | | |
| | | Protective edge: | 2 mm glue technology | ①/②-PE | | 85 | | | | | | | |
| Table top finish | Fenix NTM® | Edge: | 1 mm (matching table top colour) | ① | | • | | | | | | | |
| | Melamine (MFC) | Edge: | 2 mm glue technology | ①/② | | • | | | | | | | |
| | | Protective edge: | 2 mm glue technology | ①/②-PE | | 85 | | | | | | | |
| Media | No grommets / media ports | | | • | | | | | | | | | |
| | Media port ALL IN 1M DI80 1× power socket 3× USB chargers (1× Type A, 2× Type C) 1× HDMI, 1× RJ45 | Position: central | Colour | White | ZA001-⑧-W | | 135 | | | | | | |
| | | | Black | ZA001-⑧-B | | | | | | | | | |
| | Media port EVOnline Circle80 1M 1× power socket 1× dual charger (Type A + C) | Colour | White | YR001-⑧-W | | 110 | | | | | | | |
| Black | | | YR001-⑧-B | | | | | | | | | | |
| Base finish | Fixing part: powder-coated steel in legs colour | Legs: powder-coated aluminium | • | | | | | | | | | | |
| | Fixing part: powder-coated steel | White aluminium, RAL 9006 | Anodised aluminium legs: | Silver matt | BC-③/③ | | 13 | | | | | | |
| | | | | Silver bright | | | | | | | | | |

* x/y mm – x: overall height/y: height under table top

① – Please specify table top colour code/solid wood colour code – [see finishes](#)

② – Please specify table top edge finish – [see finishes](#)

⑧ – Please specify media port standard: CH13, FR, GB, GE

• Available as standard (included in basic price)

○ Available as an option (included in basic price)

Price list

| | | | | | | ARN MEETING TABLE LGM RC | | | | | | | | | | | | | | |
|--------------------------------------|---|----------------------------|----------------|-----------------|----------|--------------------------|---------|------|------|------|------|------|------|------|------|------|------|----|----|----|
| | | | | | | 800 | 900 | 1200 | 1000 | 1200 | 1400 | 1500 | 1200 | 1400 | 1600 | 1800 | 1800 | | | |
| | | | | | | Width (mm) | 600 | 600 | 600 | 700 | 700 | 700 | 750 | 800 | 800 | 800 | 900 | | | |
| | | | | | | Depth (mm) | 600 | 600 | 600 | 700 | 700 | 700 | 750 | 800 | 800 | 800 | 900 | | | |
| Cable management | None | | | | | | | | | | | | | | | | | • | | |
| | Vertical cable channel | Upholstered | Price group 4: | Blazer, Synergy | VC-U-⑤ | | | | | | | | | | | | | | 31 | |
| | | Flexible, plastic, modular | | | White | VC-FM-W | | | | | | | | | | | | | | 61 |
| | | | | | Colour : | Black | VC-FM-B | | | | | | | | | | | | | |
| | | | | Aluminium | VC-FM-AU | | | | | | | | | | | | | | | |
| Glides | Plastic glides | | | | GD | | | | | | | | | | | | | • | | |
| | Plastic glides with felt | | | | GDF | | | | | | | | | | | | | 11 | | |
| Table top connectors | No connector | | | | | | | | | | | | | | | | | • | | |
| | Plastic connector | | | | TC | | | | | | | | | | | | | 52 | | |
| Wood and wood-based materials | Raw material – EU Timber regulation | | | | EUTR | | | | | | | | | | | | | • | | |
| Assembly | Assembled | | | | ASM-F | | | | | | | | | | | | | • | | |
| Sample order | ARN MEETING TABLE LGM RC (W1200 D800 FSP CA/BI BC-WK/ASAM GD TC EUTR ASM-F) | | | | | | | | | | | | | | | | | | | |

⑤ – Please specify upholstery colour code from selected price group – [see finishes](#)

- Available as standard (included in basic price)
- Available as an option (included in basic price)

Arn meeting table LGW RD

Round table top.
25 mm table top thickness for melamine (MFC) finish.
27 mm table top thickness for Laminate and Fenix finish.
Base – wooden legs.



ARN MEETING TABLE LGW RD

| H (mm) | | 735/710* Melamine (MFC) 737/710* Laminate and Fenix | | | | | |
|---------------------------|--|--|----------------------------------|---------------|-----------|-----------|-----|
| WT (kg) | | 15,2 | 17,1 | 19,2 | 21,5 | 27,0 | |
| Diameter (mm) | DI•••• | 700 | 800 | 900 | 1000 | 1200 | |
| | | Basic price (EUR) according to table top finishes | | | | | |
| Laminate | | 493 | 524 | 597 | 634 | 651 | |
| Fenix NTM® | | 592 | 697 | 815 | 846 | 943 | |
| Melamine (MFC) | | 365 | 388 | 442 | 469 | 482 | |
| Table top core | Chipboard | FSP | FSP | • | | | |
| Laminate | Edge: | 2 mm glue technology | ①/② | • | | | |
| | Protective edge: | 2 mm glue technology | ①/②-PE | 85 | | | |
| Table top finish | Fenix NTM® | Edge: | 1 mm (matching table top colour) | ① | • | | |
| Melamine (MFC) | Edge: | 2 mm glue technology | ①/② | • | | | |
| | Protective edge: | 2 mm glue technology | ①/②-PE | 85 | | | |
| No grommets / media ports | | | | • | | | |
| Media | Media port ALL IN 1M DIBO 1 × power socket 3 × USB chargers (1 × Type A, 2 × Type C) 1 × HDMI, 1 × RJ45 | Position: central | Colour | White | ZA001-⑧-W | 135 | |
| | | | | Black | ZA001-⑧-B | | |
| | Media port EVoline Circle80 1M 1 × power socket 1 × dual charger (Type A + C) | | | | White | YR001-⑧-W | 110 |
| | | | | | Black | YR001-⑧-B | |
| Base finish | Fixing part: powder-coated steel | White Aluminium, RAL 9006 | Solid wood: | Natural beech | | • | |
| | | | | Stained beech | BC-WK/① | 13 | |
| | | | | Natural oak | | 105 | |

* x/y mm – x: overall height/y: height under table top

① – Please specify table top colour code/solid wood colour code – [see finishes](#)

② – Please specify table top edge finish – [see finishes](#)

⑧ – Please specify media port standard: CH13, FR, GB, GE

• Available as standard (included in basic price)

○ Available as an option (included in basic price)

Price list

| | | | | | | ARN MEETING TABLE LGW RD | | | | |
|--------------------------------------|---|----------------------------|----------------|-----------------|----------|--------------------------|-----|-----|------|------|
| | | Diameter (mm) | | | DI.... | 700 | 800 | 900 | 1000 | 1200 |
| Cable management | None | | | | | | | • | | |
| | Vertical cable channel | Upholstered | Price group 4: | Blazer, Synergy | VC-U-⑤ | | | 31 | | |
| | | Flexible, plastic, modular | Colour : | White | VC-FM-W | | | | | |
| | | | | Black | VC-FM-B | | | 61 | | |
| | | | | Aluminium | VC-FM-AU | | | | | |
| Glides | Plastic glides | | | | GD | | | • | | |
| | Plastic glides with felt | | | | GDF | | | ○ | | |
| Wood and wood-based materials | Raw material – EU Timber regulation | | | | EUTR | | | • | | |
| Wooden elements lacquering | Water lacquer UV | | | | UV | | | • | | |
| | Water lacquer | | | | | | | -40 | | |
| Assembly | Assembled | | | | ASM-F | | | • | | |
| Sample order | ARN MEETING TABLE LGW RD (DI1000 FSP CA/BI BC-SV/SKNB GD EUTR UV ASM-F) | | | | | | | | | |

⑤ – Please specify upholstery colour code from selected price group – [see finishes](#)

- Available as standard (included in basic price)
- Available as an option (included in basic price)

Connector for table tops

Either 2 on short sides or 2 on long sides.

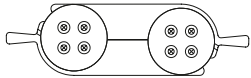

TABLE ACCESSORY TC 1

Basic price (EUR)

26

Sample order TABLE ACCESSORY TC 1

Finishes

Wood

Natural



SKNB

Natural
Beech



SKNO

Natural
Oak

Stained



2.07Y

Black



2.06S

Slate



S39

Light
Grey



2.09S

White



2.0CB

Acacia



SK40

Oak



2.0CC

Walnut

Melamine



CW

Black
Graphite



MG

Grey
Vicenza
Oak

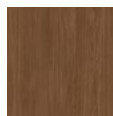

LW

Lincoln
Walnut

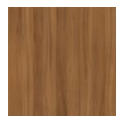

NW

Natural
Dijon
Walnut



NZ

Natural
Hickory



HO

Hamilton
Oak



ML

Kaisersberg
Oak



NJ

Acacia
Light



NH

Maple



MM

Ellmau
Beech



CC

Black



MS

Slate



MP

Platinum



MB

White
Grey



NK

Cashmere



BA

Truffle
Grey



ST

Smoke
Blue

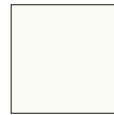

BI

White

Laminate

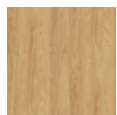

HZ

Natural
Hickory



KU

Hamilton
Oak

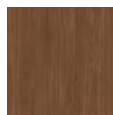

KT

Lincoln
Walnut



GN

Acacia
Light



HE

Kaisersberg
Oak



FC

Grey
Vicenza
Oak



HF

Ellmau
Beech



DD

Black



GW

Slate



BW

Platinum



CA

White



FN

White
Grey



HC

Cashmere

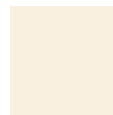

AA

Came
Beige

Fenix NTM®



KJ

Nero
Ingo



KN

Grigio
Bromo



KM

Grigio
Antrim



KP

Rosso
Jaipur



KR

Verde
Comodoro



KO

Blu
Fes

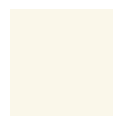

KS

Bianco
Kos

Edge

Melamine (MFC), Laminate



2 mm
plastic



2 mm
plastic with
protective
edge

Fenix NTM®



1 mm

Metal



**Anodised
Aluminium
Silver matt**
ASAM



**Anodised
Aluminium
Silver
bright**
ASAG



RAL 9003
Signal White
WS



Silk
KSK



RAL 9006
White
Aluminium
WK



Silver 98
SV



DB 703
Iron Mica
IM



RAL 9005
Jet Black
BK

General notes

All specified dimensions are approximate. Subject to minor modifications or differences for reasons of design improvements or for technical reasons.

- W = width
- D = depth
- H = height
- DI = diameter
- SH = seat height
- SH DIN = seat height measured acc. to DIN EN 1335-1
- WT = weight

In compliance with the highest quality standards "Quality is irreplaceable." Guided by this principle, each product line is subjected to stringent quality testing.

Warranty

Manufacturer declares that the products shall be free from defects in material or workmanship. The warranty is given to the original purchaser only, for normal commercial usage. Detailed terms of warranty and warranty periods are available at <https://www.kusch.com/de/garantieleistungen>.

delgado price list 2026

Delgado

Design: Robert de le Roi

Meeting table



**DELGADO MEETING
TABLE LF RC**



**DELGADO MEETING
TABLE TF RC**

Price list

Delgado meeting table LF RC

Rectangular table top.
25 mm table top thickness for melamine (MFC) finish.
27 mm table top thickness for Laminate and Fenix finish.
Base – folding legs.



DELGADO MEETING TABLE LF RC

| H (mm) | | 735/710* Melamine (MFC) 737/710* Laminate and Fenix | | | | | | | | | | |
|--------------------------------------|--|--|---------------------------------|----------------------|--------|------|------|------|------|------|------|----|
| | | 22,3 | 24,6 | 26,8 | 24,6 | 27,2 | 29,9 | 30,0 | 29,9 | 32,9 | 36,0 | |
| WT (kg) | | | | | | | | | | | | |
| Width (mm) | W... | 1200 | 1200 | 1200 | 1400 | 1400 | 1400 | 1500 | 1600 | 1600 | 1800 | |
| Depth (mm) | D... | 600 | 700 | 800 | 600 | 700 | 800 | 750 | 700 | 800 | 800 | |
| | | Basic price (EUR) according to table top finishes | | | | | | | | | | |
| Laminate | | 473 | 479 | 529 | 495 | 507 | 524 | 524 | 536 | 565 | 572 | |
| Fenix NTM® | | 602 | 638 | 707 | 657 | 672 | 694 | 694 | 710 | 836 | 843 | |
| Melamine (MFC) | | 353 | 358 | 391 | 369 | 378 | 390 | 390 | 400 | 420 | 426 | |
| Table top core | chipboard | FSP | | | | | | | | | | • |
| Table top finish | Laminate | Edge: | 2 mm glue technology | ①/② | | | | | | | | • |
| | | Protective edge: | 2 mm glue technology | ①/②-PE | | | | | | | | 85 |
| | Fenix NTM® | Edge: | 1mm (matching table top colour) | ① | | | | | | | | • |
| | | Melamine (MFC) | Edge: | 2 mm glue technology | ①/② | | | | | | | |
| | | | Protective edge: | 2 mm glue technology | ①/②-PE | | | | | | | |
| Base finish | Powder-coated | | | | | | | | | | | • |
| | Chrome | BC-③ | | | | | | | | | | 41 |
| | Satin chrome | | | | | | | | | | | 52 |
| Glides | Plastic | GD | | | | | | | | | | • |
| | Plastic with felt | GDF | | | | | | | | | | 7 |
| Table top connectors | None | | | | | | | | | | | • |
| | Plastic connectors | TC | | | | | | | | | | 52 |
| Wood and wood-based materials | Raw material – EU Timber regulation | EUTR | | | | | | | | | | • |
| Assembly | Assembled | ASM-F | | | | | | | | | | • |
| Sample order | DELGADO MEETING TABLE LF RC (W1200 D600 FSP KS BC-CR GD TC M-KUB1-KS EUTR ASM-F) | | | | | | | | | | | |

* x/y mm – x: overall height/y: height under table top

① – Please specify table top colour code/solid wood colour code – [see finishes](#)

② – Please specify table top edge finish – [see finishes](#)

③ – Please specify metal code – [see finishes](#)

• Available as standard (included in basic price)

Price list

Delgado mobile meeting table TF RC

Rectangular folding table top.
25 mm table top thickness for melamine (MFC) finish.
27 mm table top thickness for Laminate and Fenix finish.
Base – legs with castors. Horizontally stackable.



DELGADO MEETING TABLE TF RC

| | | 735/710* Melamine (MFC) 737/710* Laminate and Fenix | | | | |
|---|---|--|--------|------|------|------|
| H (mm) | | 21,5 | 26,5 | 28,5 | 29,0 | 31,5 |
| WT (kg) | | 21,5 | 26,5 | 28,5 | 29,0 | 31,5 |
| Width (mm) | W... | 1200 | 1400 | 1400 | 1500 | 1600 |
| Depth (mm) | D... | 600 | 700 | 800 | 750 | 800 |
| Basic price (EUR) according to table top finishes | | | | | | |
| Laminate | | 527 | 555 | 568 | 572 | 605 |
| Fenix NTM® | | 655 | 697 | 724 | 729 | 889 |
| Melamine (MFC) | | 393 | 414 | 423 | 426 | 451 |
| Table top core | chipboard | FSP | | | | • |
| Table top finish | Laminate | Edge: 2 mm glue technology | ①/② | | | • |
| | | Protective edge: 2 mm glue technology | ①/②-PE | | | 85 |
| | Fenix NTM® | Edge: 1 mm (matching table top colour) | ① | | | • |
| | Melamine (MFC) | Edge: 2 mm glue technology | ①/② | | | • |
| Protective edge: 2 mm glue technology | | ①/②-PE | | | 85 | |
| Base finish | Powder-coated metal | | | | | • |
| | Chromium plated metal | Chrome | BC-③ | | | 41 |
| | | Satin chrome | | | | 52 |
| Table top connectors | None | | | | | • |
| | Plastic connectors | TC | | | | 52 |
| Wood and wood-based materials | Raw material – EU Timber regulation | EUTR | | | | • |
| Assembly | Assembled | ASM-F | | | | • |
| Sample order | DELGADO MEETING TABLE TF RC (W1200 D600 FSP KS BC-CR TC EUTR ASM-F) | | | | | |

* x/y mm – x: overall height/y: height under table top

① – Please specify table top colour code/solid wood code – [see finishes](#)

② – Please specify table top edge finish – [see finishes](#)

③ – Please specify metal code – [see finishes](#)

• Available as standard (included in basic price)

Connector for table tops

Either 2 on short sides or 2 on long sides

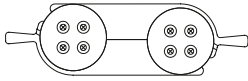

| |
|-----------------------------|
| TABLE ACCESSORY TC 1 |
| Basic price (EUR) |
| 26 |

Sample order TABLE ACCESSORY TC 1

Materials, finishes

Melamine (MFC)



Laminate

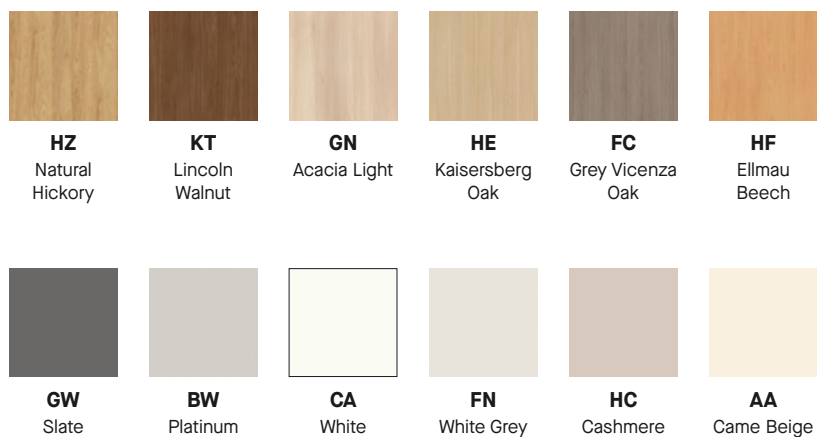

Fenix NTM®

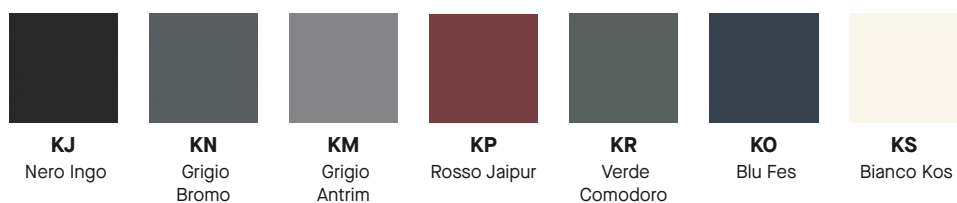

Materials, finishes

Edge

HPL Laminate



2 mm
plastic



2 mm
plastic with
protective
edge

Fenix NTM®



1 mm

Metal



**NCS S
2005-Y60R**
Cashmere
NK



RAL 1024
Ochre Yellow
OY



**RAL 030
50 40**
Vermilion
Red
VR



RAL 6003
Olive Green
OG



RAL 5000
Violet Blue
VB



Chrome
CR



**Satin
Chrome**
SCR



RAL 9016
Traffic White
WT



RAL 9006
White
Aluminium
WK



Silver 98
SV



DB 703
Iron Mica
IM



RAL 9005
Jet Black
BK

General notes

All specified dimensions are approximate. Subject to minor modifications or differences for reasons of design improvements or for technical reasons.

- W = width
- D = depth
- H = height
- DI = diameter
- SH = seat height
- SH DIN = seat height measured acc. to DIN EN 1335-1
- WT = weight

In compliance with the highest quality standards "Quality is irreplaceable." Guided by this principle, each product line is subjected to stringent quality testing.

Warranty

Manufacturer declares that the products shall be free from defects in material or workmanship. The warranty is given to the original purchaser only, for normal commercial usage. Detailed terms of warranty and warranty periods are available at <https://www.kusch.com/en/warranty>

san_siro
conference
tables
price list
2026

san_siro conference table

Design by Norbert Geelen

Conference table



SAN SIRO MEETING TABLE T-LEG RC 2



SAN SIRO MEETING TABLE T2C-LEG RC

Round table



SAN SIRO MEETING TABLE 4A RD 2

Barrel table



SAN SIRO MEETING TABLE T-LEG BR



SAN SIRO MEETING TABLE T2C-LEG BR

Price list

san_siro conference table T-LEG RC 2

Rectangular table top.
25 mm table top thickness for Melamine (MFC) and Melamina (MFC) – Organic finish.
27 mm table top thickness for Laminate and Fenix finish.
Base – metal T-legs.

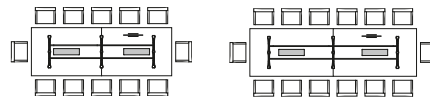

SAN SIRO MEETING TABLE T-LEG RC 2

| Table top | | 2-piece | 2-piece |
|---|---|--|---|
| Type of base | | 3 × T-LEG (one column) | 3 × T-LEG (one column) |
| Users | | up to 12 people | up to 14 people |
| H (mm) | | 735/710* Melamine (MFC) and Melamine (MFC) – Organic 737/710* Laminate and Fenix | |
| Width (mm) | W... | 3500 | 4200 |
| Depth (mm) | D... | 1200 | 1200 |
| Basic price (EUR) according to table top finishes | | | |
| Melamine (MFC) | | 1141 | 1352 |
| Melamina (MFC) – Organic | | 1313 | 1555 |
| Laminate | | 1745 | 2069 |
| Fenix NTM® | | 2588 | 3079 |
| Table top core | Chipboard | FSP | • |
| | Medium density fibreboard (MDF) | MDF | 850 |
| Table top finish for chipboard core | Melamine (MFC) | | • |
| | Melamina (MFC) – Organic | 2 mm glue technology | ①/② |
| | Laminate | | • |
| | Fenix NTM® | 1 mm (matching table top colour) | ① |
| Table top finish for medium density fibreboard (MDF) | Laminate | Chamfered edge: 2 mm glue technology | ①/②-CE |
| | Fenix NTM® | Chamfered edge: 1 mm (matching table top colour) | ①-CE |
| Media | No grommets / media ports | | • |
| | 2 × Media port Netbox Turn Comfort 4 M | Position: central left, central right | 2XYG0... See media port configuration matrix |
| Base finish | Steel column: | Powder-coated | Powder-coated BC-③ |
| | | Chrome | Aluminium foot: Polished BC-CR/POL |
| | | Satin chrome | Polished BC-SCR/POL |
| | | | 76 |
| | | | 91 |

* x/y mm – x: overall height/y: height under table top

① – Please specify table top colour code/solid wood colour code – [see finishes](#)

② – Please specify table top edge finish – [see finishes](#)

③ – Please specify metal colour code – [see finishes](#)

• Available as standard (included in basic price)

| | | | | | SAN SIRO MEETING TABLE T-LEG RC 2 |
|--------------------------------------|--|--|-----------|---|-----------------------------------|
| Cable management* | Horizontal: | None | Vertical: | None | • |
| | | Fixed, powder-coated steel (White aluminium, RAL 9006) | | Magnetic, attached to column (matching column finish) | HC-KUM2 VC-KUM3 |
| Glides | | Plastic glides | | GD | • |
| | | Plastic glides, non-skid | | GDN | 12 |
| | | Plastic glides with felt | | GDF | 17 |
| Wood and wood-based materials | | Raw material - EU Timber regulation | | EUTR | • |
| Assembly | | Partially Assembled | | ASM-P | • |
| Sample order | SAN SIRO MEETING TABLE T-LEG RC 2 (W3500 D1200 FSP KNB BC-WS GDF EUTR ASM-P) | | | | |

* A configuration without media ports does not have any wire trunking, a configuration equipped with media ports requires horizontal and vertical wire trunking (HC-KUM2 VC-KUM3)

- Available as standard (included in basic price)

Price list

san_siro conference table T-LEG RC 2

Rectangular table top.
25 mm table top thickness for Melamine (MFC) and Melamina (MFC) – Organic finish.
27 mm table top thickness for Laminate and Fenix finish.
Base – metal T-legs.

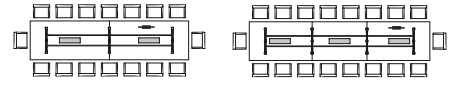

SAN SIRO MEETING TABLE T-LEG RC 2

| | | 2-piece | 3-piece | | | |
|---|---|--|--------------------------|------------|----|-----|
| Table top | | 2-piece | 3-piece | | | |
| Type of base | | 3 × T-LEG (one column) | 4 × T-LEG (one column) | | | |
| Users | | up to 16 people | up to 18 people | | | |
| H (mm) | | 735/710* Melamine (MFC) and Melamine (MFC) – Organic 737/710* Laminate and Fenix | | | | |
| Width (mm) | W... | 4900 | 5600 | | | |
| Depth (mm) | D... | 1200 | 1200 | | | |
| Basic price (EUR) according to table top finishes | | | | | | |
| Melamine (MFC) | | 1596 | 1760 | | | |
| Melamina (MFC) – Organic | | 1836 | 2024 | | | |
| Laminate | | 2440 | 2693 | | | |
| Fenix NTM® | | 3641 | 4067 | | | |
| Table top core | Chipboard | FSP | • | | | |
| | Medium density fibreboard (MDF) | MDF | 1133 | | | |
| Table top finish for chipboard core | Melamine (MFC) | | • | | | |
| | Melamina (MFC) – Organic | 2 mm glue technology | ①/② | | | |
| | Laminate | | • | | | |
| | Fenix NTM® | 1 mm (matching table top colour) | ① | | | |
| Table top finish for medium density fibreboard (MDF) core | Laminate | Chamfered edge: 2 mm glue technology | ①/②-CE | | | |
| | Fenix NTM® | Chamfered edge: 1 mm (matching table top colour) | ①-CE | | | |
| Media | No grommets / media ports | | • | | | |
| | 2 × Media port Netbox Turn Comfort 4 M | Position: central left, central right | 2XYGO... | | | |
| | 3 × Media port Netbox Turn Comfort 4 M | Position: central left, central, central right | 3XYGO... | | | |
| Base finish | Steel column: | Powder-coated | Powder-coated | BC-③ | • | |
| | | Chrome | Aluminium foot: Polished | BC-CR/POL | 76 | 100 |
| | | Satin chrome | Polished | BC-SCR/POL | 91 | 121 |
| | | | | | | |

* x/y mm – x: overall height/y: height under table top

① – Please specify table top colour code/solid wood colour code – [see finishes](#)

② – Please specify table top edge finish – [see finishes](#)

③ – Please specify metal colour code – [see finishes](#)

• Available as standard (included in basic price)

| | | | | | | SAN SIRO MEETING TABLE T-LEG RC 2 | |
|--------------------------------------|--|--|-----------|---|-----------------|-----------------------------------|-----|
| Cable management* | Horizontal: | None | Vertical: | None | HC-KUM2 VC-KUM3 | • | |
| | | Fixed, powder-coated steel (White aluminium, RAL 9006) | | Magnetic, attached to column (matching column finish) | | 431 | 561 |
| Glides | Plastic glides | | | | GD | • | |
| | Plastic glides, non-skid | | | | GDN | 12 | 16 |
| | Plastic glides with felt | | | | GDF | 17 | 22 |
| Wood and wood-based materials | Raw material - EU Timber regulation | | | | EUTR | • | |
| Assembly | Partially Assembled | | | | ASM-P | • | |
| Sample order | SAN SIRO MEETING TABLE T-LEG RC 2 (W4900 D1200 FSP KNB BC-WS GDF EUTR ASM-P) | | | | | | |

* A configuration without media ports does not have any wire trunking, a configuration equipped with media ports requires horizontal and vertical wire trunking (HC-KUM2 VC-KUM3)

- Available as standard (included in basic price)

Price list

san_siro conference table T-LEG RC 2

Rectangular table top.
25 mm table top thickness for Melamine (MFC) and Melamina (MFC) – Organic finish.
27 mm table top thickness for Laminate and Fenix finish.
Base – metal T-legs.

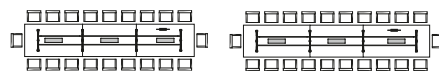

SAN SIRO MEETING TABLE T-LEG RC 2

| Table top | | 3-piece | 3-piece |
|--|--|--|---|
| Type of base | | 4 × T-LEG (one column) | 4 × T-LEG (one column) |
| Users | | up to 20 people | up to 22 people |
| H (mm) | | 735/710* Melamine (MFC) and Melamine (MFC) – Organic 737/710* Laminate and Fenix | |
| Width (mm) | W... | 6300 | 7000 |
| Depth (mm) | D... | 1200 | 1200 |
| Basic price (EUR) according to table top finishes | | | |
| Melamine (MFC) | | 1978 | 2364 |
| Melamina (MFC) – Organic | | 2275 | 2719 |
| Laminate | | 3024 | 3617 |
| Fenix NTM® | | 4577 | 5049 |
| Table top core | Chipboard | FSP | • |
| | Medium density fibreboard (MDF) | MDF | 1416 |
| Table top finish for chipboard core | Melamine (MFC) | | • |
| | Melamina (MFC) – Organic | 2 mm glue technology | ①/② |
| | Laminate | | • |
| | Fenix NTM® | 1 mm (matching table top colour) | ① |
| Table top finish for medium density fibreboard (MDF) core | Laminate | Chamfered edge: 2 mm glue technology | ①/②-CE |
| | Fenix NTM® | Chamfered edge: 1 mm (matching table top colour) | ①-CE |
| Media | No grommets / media ports | | • |
| | 3 × Media port Netbox Turn Comfort 4 M | Position: central left, central, central right | 3XYGO... See media port configuration matrix |
| Base finish | Steel column: | Powder-coated | Powder-coated BC-③ |
| | | Chrome | Aluminium foot: Polished BC-CR/POL |
| | | Satin chrome | Polished BC-SCR/POL |
| | | | 100 |
| | | | 121 |

* x/y mm – x: overall height/y: height under table top

① – Please specify table top colour code/solid wood colour code – [see finishes](#)

② – Please specify table top edge finish – [see finishes](#)

③ – Please specify metal colour code – [see finishes](#)

• Available as standard (included in basic price)

| | | | | | | SAN SIRO MEETING TABLE T-LEG RC 2 | |
|--------------------------------------|--|--|-----------|---|-----------------|-----------------------------------|-----|
| Cable management* | Horizontal: | None | Vertical: | None | HC-KUM2 VC-KUM3 | • | |
| | | Fixed, powder-coated steel (White aluminium, RAL 9006) | | Magnetic, attached to column (matching column finish) | | 569 | 608 |
| Glides | Plastic glides | | | | GD | • | |
| | Plastic glides, non-skid | | | | GDN | 16 | |
| | Plastic glides with felt | | | | GDF | 22 | |
| Wood and wood-based materials | Raw material - EU Timber regulation | | | | EUTR | • | |
| Assembly | Partially Assembled | | | | ASM-P | • | |
| Sample order | SAN SIRO MEETING TABLE T-LEG RC 2 (W6300 D1200 FSP KNB BC-WS GDF EUTR ASM-P) | | | | | | |

* A configuration without media ports does not have any wire trunking, a configuration equipped with media ports requires horizontal and vertical wire trunking (HC-KUM2 VC-KUM3)

- Available as standard (included in basic price)

Price list

san_siro conference table T2C-LEG RC

Rectangular table top.
25 mm table top thickness for Melamine (MFC) and Melamina (MFC) – Organic finish.
27 mm table top thickness for Fenix finish.
Base – metal T-legs with double column.

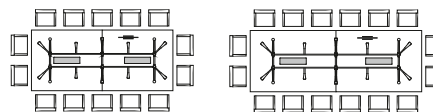

SAN SIRO MEETING TABLE T2C-LEG RC

| | | |
|--------------|---|------------------------|
| Table top | 2-piece | 2-piece |
| Type of base | 3 × T-LEG (two column) | 3 × T-LEG (two column) |
| Users | up to 14 people | up to 16 people |
| H (mm) | 735/710* Melamine (MFC) and Melamine (MFC) – Organic 737/710* Fenix | |

| | | | |
|--|---|---------------------------------------|---|
| Width (mm) | W... | 3500 | 4200 |
| Depth (mm) | D... | 1500 | 1500 |
| Basic price (EUR) according to table top finishes | | | |
| Melamine (MFC) | | 1977 | 2185 |
| Melamina (MFC) – Organic | | 2274 | 2513 |
| Fenix NTM® | | 3834 | 4238 |
| Table top core | Chipboard | FSP | • |
| | Medium density fibreboard (MDF) | MDF | 944 |
| Table top finish for chipboard core | Melamine (MFC) | | • |
| | Melamina (MFC) – Organic | 2 mm glue technology | ①② |
| | Fenix NTM® Edge: | 1 mm (matching table top colour) | ① |
| Table top finish for medium density fibreboard (MDF) core | Fenix NTM® Chamfered edge: | 1 mm (matching table top colour) | ①-CE |
| Media | No grommets / media ports | | • |
| | 2 × Media port Netbox Turn Comfort 4 M | Position: central left, central right | 2XYGO... See media port configuration matrix |
| Base finish | Steel column: | Powder-coated | Powder-coated BC-③ |
| | | Chrome | Aluminium foot: Polished BC-CR/POL |
| | | Satin chrome | Polished BC-SCR/POL |
| | | | 303 |
| | | | 349 |

* x/y mm – x: overall height/y: height under table top

① – Please specify table top colour code / solid wood colour code – [see finishes](#)

② – Please specify table top edge finish – [see finishes](#)

③ – Please specify metal colour code – [see finishes](#)

• Available as standard (included in basic price)

| | | | | | SAN SIRO MEETING TABLE T2C-LEG RC |
|--------------------------------------|--|--|-----------|---|-----------------------------------|
| Cable management* | Horizontal: | None | Vertical: | None | • |
| | | Fixed, powder-coated steel (White aluminium, RAL 9006) | | Magnetic, attached to column (matching column finish) | HC-KUM2 VC-KUM3 |
| Glides | | Plastic glides | | GD | • |
| | | Plastic glides, non-skid | | GDN | 12 |
| | | Plastic glides with felt | | GDF | 17 |
| Wood and wood-based materials | | Raw material - EU Timber regulation | | EUTR | • |
| Assembly | | Partially Assembled | | ASM-P | • |
| Sample order | SAN SIRO MEETING TABLE T2C-LEG RC (W3500 D1500 FSP KNB BC-WS GDF EUTR ASM-P) | | | | |

* A configuration without media ports does not have any wire trunking, a configuration equipped with media ports requires horizontal and vertical wire trunking (HC-KUM2 VC-KUM3)

- Available as standard (included in basic price)

Price list

san_siro conference table T2C-LEG RC

Rectangular table top.
25 mm table top thickness for Melamine (MFC) and Melamina (MFC) – Organic finish.
27 mm table top thickness for Fenix finish.
Base – metal T-legs with double column.

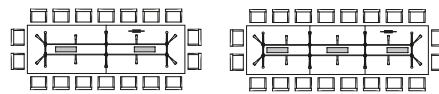

SAN SIRO MEETING TABLE T2C-LEG RC

| Table top | | 2-piece | 3-piece |
|--|---|---|--|
| Type of base | | 3 × T-LEG (two column) | 4 × T-LEG (two column) |
| Users | | up to 18 people | up to 20 people |
| H (mm) | | 735/710* Melamine (MFC) and Melamine (MFC) – Organic 737/710* Fenix | |
| Width (mm) | W... | 4900 | 5600 |
| Depth (mm) | D... | 1500 | 1500 |
| Basic price (EUR) according to table top finishes | | | |
| Melamine (MFC) | | 2578 | 2868 |
| Melamina (MFC) – Organic | | 2965 | 3299 |
| Fenix NTM® | | 5000 | 5562 |
| Table top core | Chipboard | FSP | • |
| | Medium density fibreboard (MDF) | MDF | 1227 |
| Table top finish for chipboard core | Melamine (MFC) | | • |
| | Melamina (MFC) – Organic | 2 mm glue technology | ① ② |
| | Fenix NTM® Edge: | 1 mm (matching table top colour) | ① |
| Table top finish for medium density fibreboard (MDF) core | Fenix NTM® Chamfered edge: | 1 mm (matching table top colour) | ①-CE |
| | No grommets / media ports | | • |
| Media | 2 × Media port Netbox Turn Comfort 4 M | Position: central left, central right | 2XYGO... See media port configuration matrix |
| | 3 × Media port Netbox Turn Comfort 4 M | Position: central, central left, central right | 3XYGO... – See media port configuration matrix |
| Base finish | Steel column: | Powder-coated | Powder-coated |
| | | Aluminium foot: Chrome | Polished |
| | | Satin chrome | Polished |
| | | BC-③ | • |
| | | BC-CR/POL | 303 |
| | | BC-SCR/POL | 349 |
| | | | 484 |
| | | | 556 |

* x/y mm – x: overall height/y: height under table top

① – Please specify table top colour code/solid wood colour code – [see finishes](#)

② – Please specify table top edge finish – [see finishes](#)

③ – Please specify metal colour code – [see finishes](#)

• Available as standard (included in basic price)

| | | | | | | SAN SIRO MEETING TABLE T2C-LEG RC | |
|--------------------------------------|--|--|-----------|---|-----------------|-----------------------------------|-----|
| Cable management* | Horizontal: | None | Vertical: | None | HC-KUM2 VC-KUM3 | • | |
| | | Fixed, powder-coated steel (White aluminium, RAL 9006) | | Magnetic, attached to column (matching column finish) | | 458 | 596 |
| Glides | Plastic glides | | | | GD | • | |
| | Plastic glides, non-skid | | | | GDN | 12 | 16 |
| | Plastic glides with felt | | | | GDF | 17 | 23 |
| Wood and wood-based materials | Raw material - EU Timber regulation | | | | EUTR | • | |
| Assembly | Partially Assembled | | | | ASM-P | • | |
| Sample order | SAN SIRO MEETING TABLE T2C-LEG RC (W4900 D1500 FSP KNB BC-WS GDF EUTR ASM-P) | | | | | | |

- * A configuration without media ports does not have any wire trunking, a configuration equipped with media ports requires horizontal and vertical wire trunking (HC-KUM2 VC-KUM3)
- Available as standard (included in basic price)

Price list

san_siro conference table T2C-LEG RC

Rectangular table top.
25 mm table top thickness for Melamine (MFC) and Melamina (MFC) – Organic finish.
27 mm table top thickness for Fenix finish.
Base – metal T-legs with double column.

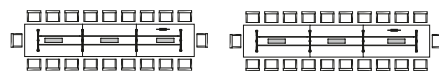

SAN SIRO MEETING TABLE T2C-LEG RC

| Table top | | 3-piece | 3-piece |
|--|---|---|---|
| Type of base | | 4 × T-LEG (two column) | 4 × T-LEG (two column) |
| Users | | up to 22 people | up to 24 people |
| H (mm) | | 735/710* Melamine (MFC) and Melamine (MFC) – Organic 737/710* Fenix | |
| Width (mm) | W... | 6300 | 7000 |
| Depth (mm) | D... | 1500 | 1500 |
| Basic price (EUR) according to table top finishes | | | |
| Melamine (MFC) | | 3159 | 3575 |
| Melamina (MFC) – Organic | | 3633 | 4112 |
| Fenix NTM® | | 6128 | 6934 |
| Table top core | Chipboard | FSP | • |
| | Medium density fibreboard (MDF) | MDF | 1510 |
| Table top finish for chipboard core | Melamine (MFC) | | • |
| | Melamina (MFC) – Organic | 2 mm glue technology | ①② |
| | Fenix NTM® Edge: | 1 mm (matching table top colour) | ① |
| Table top finish for medium density fibreboard (MDF) core | Fenix NTM® Chamfered edge: | 1 mm (matching table top colour) | ①-CE |
| Media | No grommets / media ports | | • |
| | 3 × Media port Netbox Turn Comfort 4 M | Position: central left, central, central right | 3XYGO... See media port configuration matrix |
| Base finish | Steel column: | Powder-coated | Powder-coated BC-③ |
| | | Chrome | Aluminium foot: Polished BC-CR/POL |
| | | Satin chrome | Polished BC-SCR/POL |
| | | | 484 |
| | | | 556 |

* x/y mm – x: overall height/y: height under table top

① – Please specify table top colour code / solid wood colour code – [see finishes](#)

② – Please specify table top edge finish – [see finishes](#)

③ – Please specify metal colour code – [see finishes](#)

• Available as standard (included in basic price)

| | | | | | | SAN SIRO MEETING TABLE T2C-LEG RC | |
|--------------------------------------|--|--|-----------|---|-----------------|-----------------------------------|-----|
| Cable management* | Horizontal: | None | Vertical: | None | HC-KUM2 VC-KUM3 | • | |
| | | Fixed, powder-coated steel (White aluminium, RAL 9006) | | Magnetic, attached to column (matching column finish) | | 604 | 646 |
| Glides | Plastic glides | | | | GD | • | |
| | Plastic glides, non-skid | | | | GDN | 16 | |
| | Plastic glides with felt | | | | GDF | 23 | |
| Wood and wood-based materials | Raw material - EU Timber regulation | | | | EUTR | • | |
| Assembly | Partially Assembled | | | | ASM-P | • | |
| Sample order | SAN SIRO MEETING TABLE T2C-LEG RC (W6300 D1500 FSP KNB BC-WS GDF EUTR ASM-P) | | | | | | |

* A configuration without media ports does not have any wire trunking, a configuration equipped with media ports requires horizontal and vertical wire trunking (HC-KUM2 VC-KUM3)

- Available as standard (included in basic price)

Price list

san_siro conference table 4A RD 2

Round table top.
25 mm table top thickness for Melamine (MFC) and Melamina (MFC) – Organic finish.
27 mm table top thickness for Laminate and Fenix finish.
Base – metal four arm.

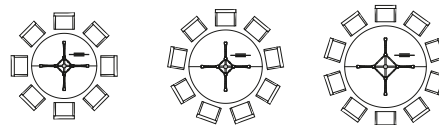

SAN SIRO MEETING TABLE 4A RD 2

| | | | |
|--------------|--|-------------------|-------------------|
| Table top | 2-piece | 2-piece | 2-piece |
| Type of base | 4A (four columns) | 4A (four columns) | 4A (four columns) |
| Users | up to 8 people | up to 9 people | up to 10 people |
| H (mm) | 735/710* Melamine (MFC) and Melamine (MFC) – Organic 737/710* Laminate and Fenix | | |

| | | | | | | |
|--|------------------------------------|--|------------------------------|---------------|------------|-----|
| Diameter (mm) | DI... | 1600 | 1800 | 2000 | | |
| Basic price (EUR) according to table top finishes | | | | | | |
| Melamine (MFC) | | 1255 | 1268 | 1371 | | |
| Melamina (MFC) – Organic | | 1444 | 1459 | 1577 | | |
| Laminate | | 1918 | 1940 | 2097 | | |
| Fenix NTM® | | 2683 | 2711 | 3155 | | |
| Table top core | Chipboard | FSP | • | | | |
| | Medium density fibreboard (MDF) | MDF | 1038 | | | |
| Table top finish for chipboard core | Laminate | Edge: 2 mm glue technology | ①/② | • | | |
| | Fenix NTM® | Edge: 1 mm (matching table top colour) | ① | • | | |
| Table top finish for medium density fibreboard (MDF) core | Laminate | Chamfered edge: 2 mm glue technology | ①/②-CE | • | | |
| | Fenix NTM® | Chamfered edge: 1 mm (matching table top colour) | ①-CE | • | | |
| | No grommets / media ports | | | • | | |
| Media | Stainless steel round grommet Ø 21 | Position: central | QN-ST | 63 | | |
| | Mat chrome round grommet Ø 80 | | QP-MCR | 140 | | |
| Base finish | Steel column: | Powder-coated | Aluminium four star element: | Powder-coated | BC-③ | • |
| | | Chrome | | Polished | BC-CR/POL | 191 |
| | | Satin chrome | | Polished | BC-SCR/POL | 233 |

* x/y mm – x: overall height/y: height under table top

① – Please specify table top colour code/solid wood colour code – [see finishes](#)

② – Please specify table top edge finish – [see finishes](#)

③ – Please specify metal colour code – [see finishes](#)

- Available as standard (included in basic price)
- Available as an option (included in basic price)

| | | | SAN SIRO MEETING TABLE 4A RD 2 |
|--------------------------------------|--|---|--------------------------------|
| Cable management | No cable management | For configuration without grommet only | • |
| | Vertical: Magnetic, attached to column (matching column finish) | Required for configuration with grommet | 116 |
| Glides | Plastic glides | VC-KUM3 | • |
| | Plastic glides, non-skid | GD | 8 |
| | Plastic glides with felt | GDN | 12 |
| Wood and wood-based materials | Raw material - EU Timber regulation | GDF | • |
| Assembly | Partially Assembled | EUTR | • |
| Sample order | SAN SIRO MEETING TABLE 4A RD 2 (DI1600 FSP KNB BC-WS GDF EUTR ASM-P) | | |

- Available as standard (included in basic price)

Price list

san_siro conference table T-LEG BR

Barrel table top.
25 mm table top thickness for Melamine (MFC) and Melamina (MFC) – Organic finish.
27 mm table top thickness for Laminate and Fenix finish.
Base – T-legs

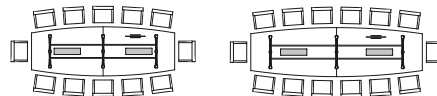

SAN SIRO MEETING TABLE T-LEG BR

| | | |
|---|--|--|
| Table top | 2-piece | 2-piece |
| Type of base | 3 × T-LEG (one column) | 3 × T-LEG (one column) |
| Users | up to 12 people | up to 14 people |
| H (mm) | 735/710* Melamine (MFC) and Melamine (MFC) – Organic 737/710* Laminate and Fenix | |
| Width (mm) | W... | 3500 |
| Depth (mm) | D... | 900/1200 |
| Basic price (EUR) according to table top finishes | | |
| Melamine (MFC) | | 1770 |
| Melamina (MFC) – Organic | | 2036 |
| Laminate | | 2707 |
| Fenix NTM® | | 3432 |
| Table top core | Chipboard | FSP |
| | Medium density fibreboard (MDF) | MDF |
| Table top finish for chipboard core | Laminate | Edge: 2 mm glue technology |
| | Fenix NTM® | Edge: 1 mm (matching table top colour) |
| Table top finish for medium density fibreboard (MDF) core | Laminate | Chamfered edge: 2 mm glue technology |
| | Fenix NTM® | Chamfered edge: 1 mm (matching table top colour) |
| Media | No grommets / media ports | |
| | 2 × Media port Netbox Turn Comfort 4 M | Position: central left, central right |
| Base finish | Steel column: | Powder-coated |
| | Aluminium foot: | Polished |
| | Satin chrome | Polished |

* x/y mm – x: overall height/y: height under table top

① – Please specify table top colour code/solid wood colour code – [see finishes](#)

② – Please specify table top edge finish – [see finishes](#)

③ – Please specify metal colour code – [see finishes](#)

• Available as standard (included in basic price)

| | | | | | SAN SIRO MEETING TABLE T-LEG BR |
|--------------------------------------|--|--|-----------|---|---------------------------------|
| Cable management* | Horizontal: | None | Vertical: | None | • |
| | | Fixed, powder-coated steel (White aluminium, RAL 9006) | | Magnetic, attached to column (matching column finish) | HC-KUM2 VC-KUM3 |
| Glides | | Plastic glides | | GD | • |
| | | Plastic glides, non-skid | | GDN | 12 |
| | | Plastic glides with felt | | GDF | 17 |
| Wood and wood-based materials | | Raw material - EU Timber regulation | | EUTR | • |
| Assembly | | Partially Assembled | | ASM-P | • |
| Sample order | SAN SIRO MEETING TABLE T-LEG BR (W3500 D900×1200 FSP KNB BC-WS GDF EUTR ASM-P) | | | | |

* A configuration without media ports does not have any wire trunking, a configuration equipped with media ports requires horizontal and vertical wire trunking (HC-KUM2 VC-KUM3)

- Available as standard (included in basic price)

Price list

san_siro conference table T-LEG BR

Barrel table top.
25 mm table top thickness for Melamine (MFC) and Melamina (MFC) – Organic finish.
27 mm table top thickness for Laminate and Fenix finish.
Base – T-legs

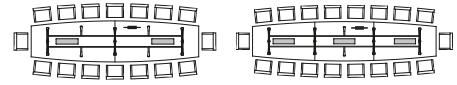

SAN SIRO MEETING TABLE T-LEG BR

| Table top | | 2-piece | 3-piece | | | |
|--|--|---|--------------------------|------------|----|-----|
| Type of base | | 3 × T-LEG (one column) | 4 × T-LEG (one column) | | | |
| Users | | up to 16 people | up to 18 people | | | |
| H (mm) | | 735/710* Melamine (MFC) and Melamine (MFC) – Organic 737/710* Laminate and Fenix | | | | |
| Width (mm) | W... | 4900 | 5600 | | | |
| Depth (mm) | D... | 900/1200 | 900/1200 | | | |
| Basic price (EUR) according to table top finishes | | | | | | |
| Melamine (MFC) | | 2125 | 2683 | | | |
| Melamina (MFC) – Organic | | 2444 | 3086 | | | |
| Laminate | | 3251 | 4103 | | | |
| Fenix NTM® | | 4486 | 5419 | | | |
| Table top core | Chipboard | FSP | • | | | |
| | Medium density fibreboard (MDF) | MDF | 1133 | | | |
| Table top finish for chipboard core | Melamine (MFC) | | • | | | |
| | Melamina (MFC) – Organic | 2 mm glue technology | ①/② | | | |
| | Laminate | | • | | | |
| | Fenix NTM® | 1 mm (matching table top colour) | ① | | | |
| Table top finish for medium density fibreboard (MDF) core | Laminate | Chamfered edge: 2 mm glue technology | ①/②-CE | | | |
| | Fenix NTM® | Chamfered edge: 1 mm (matching table top colour) | ①-CE | | | |
| Media | No grommets / media ports | | • | | | |
| | 2 × Media port Netbox Turn Comfort 4 M | Position: central left, central right | 2XYGO... | | | |
| | 3 × Media port Netbox Turn Comfort 4 M | Position: central, central left, central right | 3XYGO... | | | |
| Base finish | Steel column: | Powder-coated | Powder-coated | BC-③ | | |
| | | Chrome | Aluminium foot: Polished | BC-CR/POL | 76 | 100 |
| | | Satin chrome | Polished | BC-SCR/POL | 91 | 121 |
| | | | | | | |

* x/y mm – x: overall height/y: height under table top

① – Please specify table top colour code/solid wood colour code – [see finishes](#)

② – Please specify table top edge finish – [see finishes](#)

③ – Please specify metal colour code – [see finishes](#)

• Available as standard (included in basic price)

| | | | | | | SAN SIRO MEETING TABLE T-LEG BR | |
|--------------------------------------|--|--|-----------|---|-----------------|---------------------------------|-----|
| Cable management* | Horizontal: | None | Vertical: | None | HC-KUM2 VC-KUM3 | • | |
| | | Fixed, powder-coated steel (White aluminium, RAL 9006) | | Magnetic, attached to column (matching column finish) | | 431 | 561 |
| Glides | Plastic glides | | | | GD | • | |
| | Plastic glides, non-skid | | | | GDN | 12 | 16 |
| | Plastic glides with felt | | | | GDF | 17 | 22 |
| Wood and wood-based materials | Raw material - EU Timber regulation | | | | EUTR | • | |
| Assembly | Partially Assembled | | | | ASM-P | • | |
| Sample order | SAN SIRO MEETING TABLE T-LEG BR (W4900 D900×1200 FSP KNB BC-WS GDF EUTR ASM-P) | | | | | | |

- * A configuration without media ports does not have any wire trunking, a configuration equipped with media ports requires horizontal and vertical wire trunking (HC-KUM2 VC-KUM3)
- Available as standard (included in basic price)

Price list

san_siro conference table T-LEG BR

Barrel table top.
25 mm table top thickness for Melamine (MFC) and Melamina (MFC) – Organic finish.
27 mm table top thickness for Laminate and Fenix finish.
Base – metal T-legs.

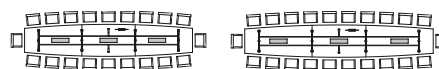

SAN SIRO MEETING TABLE T-LEG BR

| Table top | | 3-piece | 3-piece |
|--|---|--|---|
| Type of base | | 4 × T-LEG (one column) | 4 × T-LEG (one column) |
| Users | | up to 20 people | up to 22 people |
| H (mm) | | 735/710* Melamine (MFC) and Melamine (MFC) – Organic 737/710* Laminate and Fenix | |
| Width (mm) | W... | 6300 | 7000 |
| Depth (mm) | D... | 900/1200 | 900/1200 |
| Basic price (EUR) according to table top finishes | | | |
| Melamine (MFC) | | 3079 | 3096 |
| Melamina (MFC) – Organic | | 3541 | 3561 |
| Laminate | | 4710 | 4735 |
| Fenix NTM® | | 6544 | 6636 |
| Table top core | Chipboard | FSP | • |
| | Medium density fibreboard (MDF) | MDF | 1416 |
| Table top finish for chipboard core | Melamine (MFC) | | • |
| | Melamina (MFC) – Organic | 2 mm glue technology | ①/② |
| | Laminate | | • |
| | Fenix NTM® | 1 mm (matching table top colour) | ① |
| Table top finish for medium density fibreboard (MDF) core | Laminate | Chamfered edge: 2 mm glue technology | ①/②-CE |
| | Fenix NTM® | Chamfered edge: 1 mm (matching table top colour) | ①-CE |
| Media | No grommets / media ports | | • |
| | 3 × Media port Netbox Turn Comfort 4 M | Position: central left, central, central right | 3XYGO... See media port configuration matrix |
| Base finish | Steel column: | Powder-coated | Powder-coated BC-③ |
| | | Chrome | Aluminium foot: Polished BC-CR/POL |
| | | Satin chrome | Polished BC-SCR/POL |
| | | | 100 |
| | | | 121 |

* x/y mm – x: overall height/y: height under table top

① – Please specify table top colour code/solid wood colour code – [see finishes](#)

② – Please specify table top edge finish – [see finishes](#)

③ – Please specify metal colour code – [see finishes](#)

• Available as standard (included in basic price)

| | | | | | | SAN SIRO MEETING TABLE T-LEG BR | |
|--------------------------------------|--|--|-----------|---|-----------------|---------------------------------|-----|
| Cable management* | Horizontal: | None | Vertical: | None | HC-KUM2 VC-KUM3 | • | |
| | | Fixed, powder-coated steel (White aluminium, RAL 9006) | | Magnetic, attached to column (matching column finish) | | 569 | 608 |
| Glides | Plastic glides | | | | GD | • | |
| | Plastic glides, non-skid | | | | GDN | 16 | |
| | Plastic glides with felt | | | | GDF | 22 | |
| Wood and wood-based materials | Raw material - EU Timber regulation | | | | EUTR | • | |
| Assembly | Partially Assembled | | | | ASM-P | • | |
| Sample order | SAN SIRO MEETING TABLE T-LEG BR (W6300 D900×1200 FSP KNB BC-WS GDF EUTR ASM-P) | | | | | | |

* A configuration without media ports does not have any wire trunking, a configuration equipped with media ports requires horizontal and vertical wire trunking (HC-KUM2 VC-KUM3)

- Available as standard (included in basic price)

Price list

san_siro conference table T2C-LEG BR

Barrel table top.
 25 mm table top thickness for Melamine (MFC) and Melamina (MFC) – Organic finish.
 27 mm table top thickness for Laminate and Fenix finish.
 Base – metal T-legs with double column

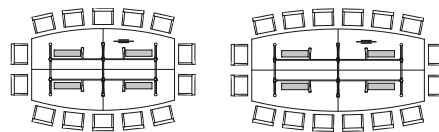

SAN SIRO MEETING TABLE T2C-LEG BR

| Table top | | 4-piece | 4-piece |
|--|--|--|---|
| Type of base | | 3 × T-LEG (two column) | 3 × T-LEG (two column) |
| Users | | up to 14 people | up to 16 people |
| H (mm) | | 735/710* Melamine (MFC) and Melamine (MFC) – Organic 737/710* Laminate and Fenix | |
| Width (mm) | W... | 3500 | 4200 |
| Depth (mm) | D... | 1500/2000 | 1500/2000 |
| Basic price (EUR) according to table top finishes | | | |
| Melamine (MFC) | | 3927 | 4270 |
| Melamina (MFC) – Organic | | 4517 | 4911 |
| Laminate | | 6071 | 6603 |
| Fenix NTM® | | 7019 | 7559 |
| Table top core | Chipboard | FSP | • |
| | Medium density fibreboard (MDF) | MDF | 1604 |
| Table top finish for chipboard core | Melamine (MFC) | | • |
| | Melamina (MFC) – Organic | 2 mm glue technology | ①/② |
| | Laminate | | • |
| | Fenix NTM® | 1 mm (matching table top colour) | ① |
| Table top finish for medium density fibreboard (MDF) core | Laminate | Chamfered edge: 2 mm glue technology | ①/②-CE |
| | Fenix NTM® | Chamfered edge: 1 mm (matching table top colour) | ①-CE |
| Media | No grommets / media ports | | • |
| | 4 × Media port Netbox Turn Comfort 4 M | Position: 2 × central left, 2 × central right | 4XYG0... See media port configuration matrix |
| Base finish | Steel column: | Powder-coated | Powder-coated BC-③ |
| | | Chrome | Aluminium foot: Polished BC-CR/POL |
| | | Satin chrome | Polished BC-SCR/POL |
| | | | 349 |

* x/y mm – x: overall height/y: height under table top

① – Please specify table top colour code/solid wood colour code – [see finishes](#)

② – Please specify table top edge finish – [see finishes](#)

③ – Please specify metal colour code – [see finishes](#)

• Available as standard (included in basic price)

| | | | | | SAN SIRO MEETING TABLE T2C-LEG BR |
|--------------------------------------|---|--|-----------|---|-----------------------------------|
| Cable management* | Horizontal: | None | Vertical: | None | • |
| | | Fixed, powder-coated steel (White aluminium, RAL 9006) | | Magnetic, attached to column (matching column finish) | HC-KUM2 VC-KUM3 |
| Glides | | Plastic glides | | GD | • |
| | | Plastic glides, non-skid | | GDN | 12 |
| | | Plastic glides with felt | | GDF | 17 |
| Wood and wood-based materials | | Raw material - EU Timber regulation | | EUTR | • |
| Assembly | | Partially Assembled | | ASM-P | • |
| Sample order | SAN SIRO MEETING TABLE T2C-LEG BR (W3500 D1500×2000 FSP KNB BC-WS GDF EUTR ASM-P) | | | | |

* A configuration without media ports does not have any wire trunking, a configuration equipped with media ports requires horizontal and vertical wire trunking (HC-KUM2 VC-KUM3)

- Available as standard (included in basic price)

Price list

san_siro conference table T2C-LEG BR

Barrel table top.
 25 mm table top thickness for Melamine (MFC) and Melamina (MFC) – Organic finish.
 27 mm table top thickness for Laminate and Fenix finish.
 Base – metal T-legs with double column.

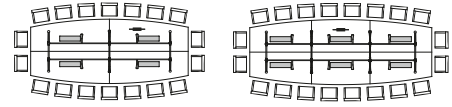

SAN SIRO MEETING TABLE T2C-LEG BR

| | | 4-piece | 6-piece | | | |
|---|--|---|--------------------------|------------|-----|-----|
| Table top | | 4-piece | 6-piece | | | |
| Type of base | | 3 × T-LEG (two column) | 4 × T-LEG (two column) | | | |
| Users | | up to 18 people | up to 20 people | | | |
| H (mm) | | 735/710* Melamine (MFC) and Melamine (MFC) – Organic 737/710* Laminate and Fenix | | | | |
| Width (mm) | W... | 4900 | 5600 | | | |
| Depth (mm) | D... | 1500/2000 | 1500/2000 | | | |
| Basic price (EUR) according to table top finishes | | | | | | |
| Melamine (MFC) | | 4598 | 5978 | | | |
| Melamina (MFC) – Organic | | 5288 | 6875 | | | |
| Laminate | | 7111 | 9244 | | | |
| Fenix NTM® | | 9098 | 11160 | | | |
| Table top core | Chipboard | FSP | • | | | |
| | Medium density fibreboard (MDF) | MDF | 2076 | | | |
| Table top finish for chipboard core | Melamine (MFC) | | • | | | |
| | Melamina (MFC) – Organic | 2 mm glue technology | ①/② | | | |
| | Laminate | | • | | | |
| | Fenix NTM® | 1 mm (matching table top colour) | ① | | | |
| Table top finish for medium density fibreboard (MDF) core | Laminate | Chamfered edge: 2 mm glue technology | ①/②-CE | | | |
| | Fenix NTM® | Chamfered edge: 1 mm (matching table top colour) | ①-CE | | | |
| Media | No grommets / media ports | | • | | | |
| | 2 × Media port Netbox Turn Comfort 4 M | Position: central left, central right | 4XYG0... | | | |
| | 3 × Media port Netbox Turn Comfort 4 M | Position: central, central left, central right | 6XYG0... | | | |
| Base finish | Steel column: | Powder-coated | Powder-coated | BC-③ | • | |
| | | Chrome | Aluminium foot: Polished | BC-CR/POL | 303 | 484 |
| | | Satin chrome | Polished | BC-SCR/POL | 349 | 556 |
| | | | | | | |

* x/y mm – x: overall height/y: height under table top

① – Please specify table top colour code/solid wood colour code – [see finishes](#)

② – Please specify table top edge finish – [see finishes](#)

③ – Please specify metal colour code – [see finishes](#)

• Available as standard (included in basic price)

| | | | | | | SAN SIRO MEETING TABLE T2C-LEG BR | |
|--------------------------------------|---|--|-----------|---|-----------------|-----------------------------------|-----|
| Cable management* | Horizontal: | None | Vertical: | None | HC-KUM2 VC-KUM3 | • | |
| | | Fixed, powder-coated steel (White aluminium, RAL 9006) | | Magnetic, attached to column (matching column finish) | | 458 | 596 |
| Glides | Plastic glides | | | | GD | • | |
| | Plastic glides, non-skid | | | | GDN | 12 | 16 |
| | Plastic glides with felt | | | | GDF | 17 | 23 |
| Wood and wood-based materials | Raw material - EU Timber regulation | | | | EUTR | • | |
| Assembly | Partially Assembled | | | | ASM-P | • | |
| Sample order | SAN SIRO MEETING TABLE T2C-LEG BR (W4900 D1500×2000 FSP KNB BC-WS GDF EUTR ASM-P) | | | | | | |

- * A configuration without media ports does not have any wire trunking, a configuration equipped with media ports requires horizontal and vertical wire trunking (HC-KUM2 VC-KUM3)
- Available as standard (included in basic price)

Price list

san_siro conference table T2C-LEG BR

Barrel table top.
25 mm table top thickness for Melamine (MFC) and Melamina (MFC) – Organic finish.
27 mm table top thickness for Laminate and Fenix finish.
Base – metal T-legs with double column.

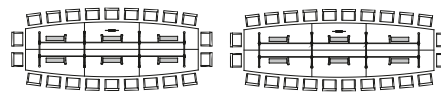

SAN SIRO MEETING TABLE T2C-LEG BR

| Table top | | 6-piece | 6-piece |
|--|---|--|---|
| Type of base | | 4 × T-LEG (two column) | 4 × T-LEG (two column) |
| Users | | up to 22 people | up to 24 people |
| H (mm) | | 735/710* Melamine (MFC) and Melamine (MFC) – Organic 737/710* Laminate and Fenix | |
| Width (mm) | W... | 6300 | 7000 |
| Depth (mm) | D... | 1500/2000 | 1500/2000 |
| Basic price (EUR) according to table top finishes | | | |
| Melamine (MFC) | | 6748 | 6778 |
| Melamina (MFC) – Organic | | 7761 | 7795 |
| Laminate | | 10434 | 10483 |
| Fenix NTM® | | 13097 | 13245 |
| Table top core | Chipboard | FSP | • |
| | Medium density fibreboard (MDF) | MDF | 2359 |
| Table top finish for chipboard core | Melamine (MFC) | | • |
| | Melamina (MFC) – Organic | 2 mm glue technology | ①/② |
| | Laminate | | • |
| | Fenix NTM® | 1 mm (matching table top colour) | ① |
| Table top finish for medium density fibreboard (MDF) core | Laminate | Chamfered edge: 2 mm glue technology | ①/②-CE |
| | Fenix NTM® | Chamfered edge: 1 mm (matching table top colour) | ①-CE |
| Media | No grommets / media ports | | • |
| | 6 × Media port Netbox Turn Comfort 4 M | Position: 2 × central, 2 × central left, 2 × central right | 6XYGO... See media port configuration matrix |
| Base finish | Steel column: | Powder-coated | Powder-coated BC-③ |
| | | Chrome | Aluminium foot: Polished BC-CR/POL |
| | | Satin chrome | Polished BC-SCR/POL |
| | | | 484 |
| | | | 556 |

* x/y mm – x: overall height/y: height under table top

① – Please specify table top colour code/solid wood colour code – [see finishes](#)

② – Please specify table top edge finish – [see finishes](#)

③ – Please specify metal colour code – [see finishes](#)

• Available as standard (included in basic price)

| | | | | | | SAN SIRO MEETING TABLE T2C-LEG BR | |
|--------------------------------------|---|--|-----------|---|-----------------|-----------------------------------|-----|
| Cable management* | Horizontal: | None | Vertical: | None | HC-KUM2 VC-KUM3 | | |
| | | Fixed, powder-coated steel (White aluminium, RAL 9006) | | Magnetic, attached to column (matching column finish) | | 604 | 646 |
| Glides | | Plastic glides | | | GD | | • |
| | | Plastic glides, non-skid | | | GDN | | 16 |
| | | Plastic glides with felt | | | GDF | | 23 |
| Wood and wood-based materials | | Raw material - EU Timber regulation | | | EUTR | | • |
| Assembly | | Partially Assembled | | | ASM-P | | • |
| Sample order | SAN SIRO MEETING TABLE T2C-LEG BR (W6300 D1500×2000 FSP KNB BC-WS GDF EUTR ASM-P) | | | | | | |

- * A configuration without media ports does not have any wire trunking, a configuration equipped with media ports requires horizontal and vertical wire trunking (HC-KUM2 VC-KUM3)
- Available as standard (included in basic price)

Price list

Media ports

| | Media ports configuration | Standard | Finish | Price (EUR) |
|--|---|------------------------------------|--------------------|-------------|
| Media port Netbox Turn Comfort 4M | 3 × power socket 1 × USB charger (type C) | YG012-⑧-SM | | 385 |
| | 3 × power socket 1 × HDMI with connection cable 2900 mm length | ⑧ - CH23, FR, GB, GE YG010-⑧-SM | SM Silver metallic | 860 |

⑧ - Please specify media port standard: CH23, FR, GB, GE

Finishes

Melamine (MFC)



Melamine (MFC) – Organic

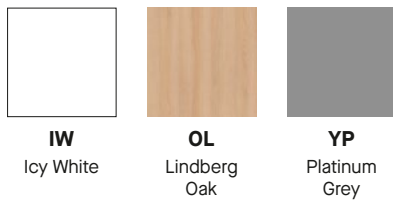

Laminate

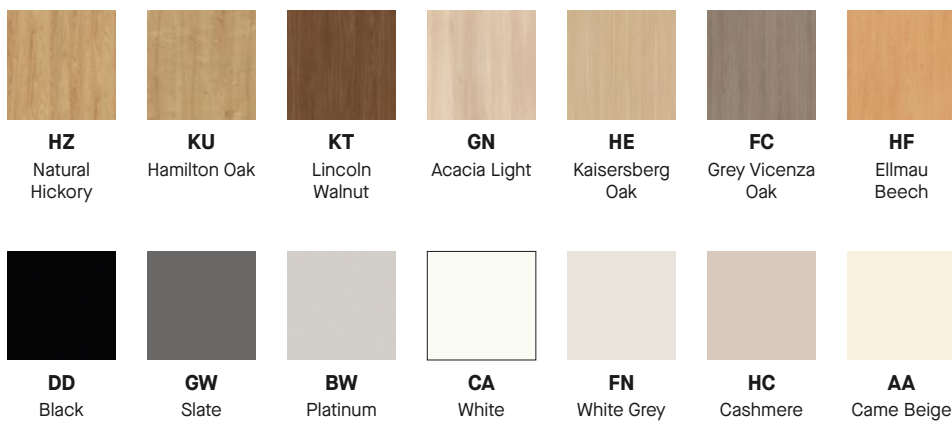

Fenix NTM®

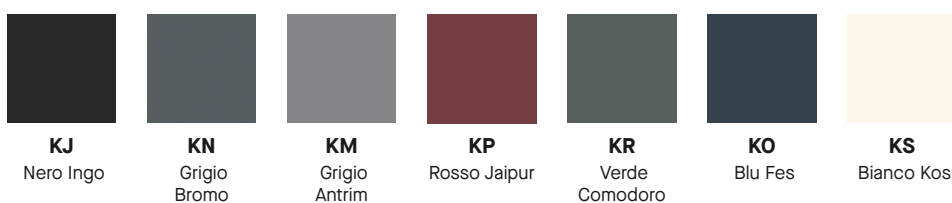

Finishes

Edge

HPL Laminate



2 mm
plastic



2 mm
plastic on
MDF,
50 mm
chamfered
lipping

Fenix NTM®



1 mm

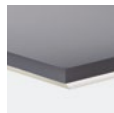

1 mm
on MDF,
50 mm
chamfered
lipping

Metal



**NCS S
2005-Y60R**
Cashmere
NK



RAL 1024
Ochre Yellow
OY



**RAL 030
50 40**
Vermilion
Red
VR



RAL 6003
Olive Green
OG



RAL 5000
Violet Blue
VB



Chrome
CR



**Satin
Chrome**
SCR



**Polished
Aluminium**
POL



RAL 9003
Signal White
WS



RAL 9006
White
Aluminium
WK



Silver 98
SV



DB 703
Iron Mica
IM



RAL 9005
Jet Black
BK

General notes

All specified dimensions are approximate. Subject to minor modifications or differences for reasons of design improvements or for technical reasons.

- W = width
- D = depth
- H = height
- DI = diameter
- SH = seat height
- SH DIN = seat height measured acc. to DIN EN 1335-1
- WT = weight

In compliance with the highest quality standards "Quality is irreplaceable." Guided by this principle, each product line is subjected to stringent quality testing.

Warranty

Manufacturer declares that the products shall be free from defects in material or workmanship.

The warranty is given to the original purchaser only, for normal commercial usage.

Detailed terms of warranty and warranty periods are available at

<https://www.kusch.com/en/warranty>

Kusch + Co GmbH
P.O. Box 1151
59965 Hallenberg
Germany

T +49 2984 300-0
welcome@kusch.com
kusch.com

creva
tables
price list
2026

Creva

Design by kaschkasch

Table on wooden legs



CREVA MEETING TABLE
LGW SQ



CREVA MEETING TABLE
LGW RC



CREVA MEETING TABLE
LGW RD



CREVA MEETING TABLE
LGW RCR

High meeting tables on wooden legs



CREVA MEETING TABLE H
LGW RC



CREVA MEETING TABLE H
LGW RCR

Meeting tables on wooden legs, with gap



CREVA MEETING TABLE
LGW RCG



CREVA MEETING TABLE
LGW RCRG

High meeting tables on wooden legs, with gap



CREVA MEETING TABLE H
LGW RCG



CREVA MEETING TABLE H
LGW RCRG

Table on metal legs



CREVA MEETING TABLE
LGM SQ



CREVA MEETING TABLE
LGM RC



CREVA MEETING TABLE
LGM RD



CREVA MEETING TABLE
LGM RCR

High meeting tables on metal legs



CREVA MEETING TABLE H
LGM RC



CREVA MEETING TABLE H
LGM RCR

Meeting tables on metal legs, with gap



CREVA MEETING TABLE
LGM RCG



CREVA MEETING TABLE
LGM RCRG

High meeting tables on metal legs, with gap



CREVA MEETING TABLE H
LGM RCG



CREVA MEETING TABLE H
LGM RCRG

Accessories



DESK PANEL
KU UP UPH 1



TABLE ACCESSORY
KU TRAY W 1

Price list

Creva meeting table LGW SQ

Square table top.
25 mm table top thickness for Melamine (MFC) finish.
27 mm table top thickness for Laminate, Veneer and Fenix finish.
Base – wooden legs.



CREVA MEETING TABLE LGW SQ

| | | |
|----------------|--|-----|
| Table top | 1-piece | |
| Number of legs | 4 | |
| Users | up to 4 people | |
| H (mm) | 739/714* Melamine (MFC) 741/714* Fenix, Laminat, Fornir | |
| WT (kg) | 42,3 | 571 |

| | | | |
|--|------|------|------|
| Width (mm) | W... | 1200 | 1500 |
| Depth (mm) | D... | 1200 | 1500 |
| Basic price (EUR) according to table top finishes | | | |
| Melamine (MFC) | | 1106 | 1379 |
| Laminate | | 1581 | — |
| Fenix NTM® | | 1824 | 2274 |
| Veneer | | 1957 | — |

| | | | |
|--|--|--|--------|
| Table top core | Chipboard | FSP | • |
| | Medium density fibreboard (MDF) | MDF | 312 |
| Table top finish for chipboard core | Melamine (MFC) | 2 mm glue technology | ①/② |
| | Laminate | Edge: | • |
| | Fenix NTM® | 1 mm (matching table top colour) | ① |
| | Veneer | 2 mm natural (matching table top colour) | • |
| Table top finish for medium density fibreboard (MDF) core | Laminate | 2 mm glue technology | ①/②-CE |
| | Fenix NTM® | Chamfered edge: 1 mm (matching table top colour) | ①-CE |
| | Veneer | 2 mm natural (matching table top colour) | • |
| Base finish | Solid wood legs: | natural | BC-① |
| | | stained | 15 |
| Glides | Plastic | GD | • |
| | Plastic with felt | GDF | ○ |
| Wood and wood-based materials | Raw material - EU Timber regulation | EUTR | • |
| Wooden elements lacquering | Water lacquer UV | UV | • |
| | Water lacquer | | -20 |
| Assembly | Partially Assembled | ASM-P | • |
| Sample order | CREVA MEETING TABLE LGW SQ (W1200 D1200 FSP KNB BC-SKNB GDF EUTR UV ASM-P) | | |

* x/y mm – x: overall height/y: height under table top

① – Please specify table top colour code/solid wood colour code – [see finishes](#)

② – Please specify table top edge finish – [see finishes](#)

- Available as standard (included in basic price)
- Available as an option (included in basic price)

Creva meeting table LGW RC

Rectangular table top.
25 mm table top thickness for Melamine (MFC) finish.
27 mm table top thickness for Laminate, Veneer and Fenix finish.
Base – wooden legs.



CREVA MEETING TABLE LGW RC

| | | | | | | | | | | |
|----------------------|--|----------------|-----------------|----------------|-----------------|-----------------|-----------------|-----------------|-------|---|
| Number of table tops | Melamine (MFC) | 1 | 1 | 2 | 1 | 2 | 2 | 2 | 2 | 2 |
| | Laminate | 1 | 1 | – | 1 | – | 2 | – | – | – |
| | Fenix NTM® | 1 | 1 | 1 | 1 | 1 | 2 | 1 | 2 | 2 |
| | Veneer | 1 | 1 | 2 | 1 | 2 | 2 | – | – | – |
| Number of legs | 4 | 4 | 4 | 4 | 4 | 6 | 4 | 6 | 6 | |
| Users | up to 6 people | up to 8 people | up to 10 people | up to 8 people | up to 10 people | up to 12 people | up to 14 people | up to 16 people | | |
| H (mm) | 739/714* Melamine (MFC) 741/714* Fenix, Laminat, Fornir | | | | | | | | | |
| WT (kg) | 48,1 | 59,1 | 70,3 | 67,7 | 81,1 | 101,9 | 100,9 | 113,9 | 143,4 | |

| | | | | | | | | | | | |
|----------------|------|--|------|------|------|------|------|------|------|------|--|
| Width (mm) | W... | 1800 | 2400 | 3000 | 2400 | 3000 | 3600 | 3000 | 3600 | 4200 | |
| Depth (mm) | D... | 1000 | | | 1200 | | | 1500 | | | |
| | | Basic price (EUR) according to table top finishes | | | | | | | | | |
| Melamine (MFC) | | 1301 | 1567 | 1663 | 1536 | 1624 | 2140 | 1845 | 2508 | 2950 | |
| Laminate | | 1752 | 2109 | – | 2193 | – | 3057 | – | – | – | |
| Fenix NTM® | | 2143 | 2584 | 2740 | 2532 | 2678 | 3528 | 3041 | 4136 | 4863 | |
| Veneer | | 2168 | 2610 | 2765 | 2716 | 2870 | 3784 | – | – | – | |

| | | | | | | | | | | | | |
|---|---|--|----------|-----|-----|-----|-----|-----|-----|----------------|-----|----------------|
| Table top core | Chipboard | FSP | | | | | | | | | | |
| | Medium density fibreboard (MDF) | MDF | 425 | 425 | 425 | 400 | 534 | 534 | 534 | 711 | 933 | |
| Table top finish for chipboard core | Melamine (MFC) | 2 mm glue technology | ① | ② | | | | | | | | |
| | Laminate | Edge: | • | • | – | • | – | • | – | – | – | |
| | Fenix NTM® | 1 mm (matching table top colour) | ① | | | | | | | | | |
| | Veneer | 2 mm natural (matching table top colour) | • | • | • | • | • | • | – | – | – | |
| Table top finish for medium density fibreboard (MDF) core | Laminate | Chamfered edge: 2 mm glue technology | ① | ② | –CE | • | • | – | • | – | – | |
| | Fenix NTM® | Chamfered edge: 1 mm (matching table top colour) | ① | –CE | | | | | | | | |
| | Veneer | 2 mm natural (matching table top colour) | • | • | • | • | • | • | – | – | – | |
| Media | No grommets / media ports | | | | | | | | | | | |
| | 1 × Media port Netbox turn Comfort 4 M | Central position | YGO... | | | | | | – | See media port | – | – |
| | 2 × Media port Netbox turn Comfort 4 M | Central left and right position | 2XYGO... | – | – | – | – | – | – | See media port | – | See media port |

* x/y mm – x: overall height/y: height under table top

① – Please specify table top colour code/solid wood ccolour code – see finishes

② – Please specify table top edge finish – see finishes

• Available as standard (included in basic price)

Price list

| | | CREVA MEETING TABLE LGW RC | | | | | | | | | | | | |
|--------------------------------------|--|----------------------------|-------------------|---------------------------|----------|---------------|------|------|------|------|------|----------|-----|-----|
| Width (mm) | | W... | 1800 | 2400 | 3000 | 2400 | 3000 | 3600 | 3000 | 3600 | 4200 | | | |
| Depth (mm) | | D... | 1000 | | | 1200 | | | 1500 | | | | | |
| Base finish | Solid wood legs: | natural | BC-① | | | | | | | | | • | | |
| | | stained | | | | | | | | | | 15 | | |
| Cable management | No cable management | | • | | | | | | | | | | | |
| | Horizontal: | felt, grey colour | | | | | | | | | | HC-KUFL1 | 201 | 211 |
| | Vertical: | upholstered, black colour | VC-U-STG60999 | 34 | | | | | | | | | | |
| | Horizontal: | Vertical: | felt, grey colour | upholstered, black colour | HC-KUFL1 | VC-U-STG60999 | 235 | 245 | 357 | 233 | 338 | 383 | 338 | 383 |
| Glides | Plastic | | GD | | | | | | | | | • | | |
| | Plastic with felt | | | | | | | | | | | GDF | o | |
| Wood and wood-based materials | Raw material - EU Timber regulation | | EUTR | | | | | | | | | • | | |
| Wooden elements lacquering | Water lacquer UV | | UV | | | | | | | | | • | | |
| | Water lacquer | | -20 | -20 | -20 | -20 | -20 | -50 | -20 | -50 | -50 | | | |
| Assembly | Partially Assembled | | ASM-P | | | | | | | | | • | | |
| Sample order | CREVA MEETING TABLE LGW RC (W1800 D1000 FSP KNB BC-SKNB GDF EUTR UV ASM-P) | | | | | | | | | | | | | |

① – Please specify table top colour code / solid wood colour code – [see finishes](#)

- Available as standard (included in basic price)
- o Available as an option (included in basic price)

Creva meeting table LGW RD

Round table top.
25 mm table top thickness for Melamine (MFC) finish.
27 mm table top thickness for Laminate, Veneer and Fenix finish.
Base – wooden legs.



CREVA MEETING TABLE LGW RD

| | | |
|----------------|--|----------------|
| Table top | 1-piece | 1-piece |
| Number of legs | 4 | 4 |
| Users | up to 4 people | up to 4 people |
| H (mm) | 739/714* Melamine (MFC) 741/714* Fenix, Laminat, Fornir | |
| WT (kg) | 35,0 | 46,7 |

| | | | |
|--|------|------|------|
| Diameter (mm) | D... | 1200 | 1500 |
| Basic price (EUR) according to table top finishes | | | |
| Melamine (MFC) | | 973 | 1207 |
| Laminate | | 1390 | – |
| Fenix NTM® | | 1607 | 1993 |
| Veneer | | 1722 | – |

| | | | | | |
|--|-------------------------------------|--|--------|--|-----|
| Table top core | chipboard | | FSP | | • |
| | Medium density fibreboard (MDF) | | MDF | | 312 |
| Table top finish for chipboard core | Melamine (MFC) | | | | • |
| | Laminate | 2 mm glue technology | ①/② | | • |
| | Fenix NTM® | Edge: 1 mm (matching table top colour) | ① | | • |
| | Veneer | 2 mm natural (matching table top colour) | | | • |
| Table top finish for medium density fibreboard (MDF) core | Laminate | Chamfered edge: 2 mm glue technology | ①/②-CE | | • |
| | Fenix NTM® | Chamfered edge: 1 mm (matching table top colour) | ①-CE | | • |
| | Veneer | 2 mm natural (matching table top colour) | | | • |
| Base finish | Solid wood legs: | natural | | | • |
| | | stained | BC-① | | 15 |
| Glides | Plastic | | GD | | • |
| | Plastic with felt | | GDF | | ○ |
| Wood and wood-based materials | Raw material - EU Timber regulation | | EUTR | | • |
| Wooden elements lacquering | Water lacquer UV | | UV | | • |
| | Water lacquer | | | | -20 |
| Assembly | Partially Assembled | | ASM-P | | • |

Sample order CREVA MEETING TABLE LGW RD (D1200 FSP KNB BC-SKNB GDF EUTR UV ASM-P)

* x/y mm – x: overall height/y: height under table top

① – Please specify table top colour code/solid wood colour code – [see finishes](#)

② – Please specify table top edge finish – [see finishes](#)

• Available as standard (included in basic price)

○ Available as an option (included in basic price)

Price list

CREVA meeting table LGW RCR

Soft rectangular table top with rounded edges.
25 mm table top thickness for Melamine (MFC) finish.
27 mm table top thickness for Laminate, Veneer and Fenix finish.
Base – wooden legs.



CREVA MEETING TABLE LGW RCR

| | | | | | | |
|----------------------|----------------|--|-----------------|-----------------|-----------------|-----------------|
| Number of table tops | Melamine (MFC) | 1 | 2 | 2 | 2 | 2 |
| | Laminate | 1 | – | – | – | – |
| | Fenix NTM® | 1 | 1 | 1 | 2 | 2 |
| | Veneer | 1 | 2 | – | – | – |
| Number of legs | | 4 | 4 | 4 | 6 | 6 |
| Users | | up to 8 people | up to 10 people | up to 12 people | up to 12 people | up to 14 people |
| H (mm) | | 739/714* Melamine (MFC) 741/714* Fenix, Laminat, Fornir | | | | |
| WT (kg) | | 61,6 | 73,2 | 82,9 | 112,6 | 127,0 |

| | | | | | | |
|--|------|--------------|--------------|--------------|--------------|--------------|
| Width (mm) | W••• | 2400 | 3000 | 3000 | 3600 | 4200 |
| Depth (mm) | D••• | 1200/ 780 | 1200/ 700 | 1500/ 980 | 1500/ 950 | 1500/ 800 |
| Basic price (EUR) according to table top finishes | | | | | | |
| Melamine (MFC) | | 1767 | 1866 | 2122 | 2884 | 3393 |
| Laminate | | 2525 | – | – | – | – |
| Fenix NTM® | | 2909 | 3079 | 3499 | 4754 | 5590 |
| Veneer | | 3121 | 3302 | – | – | – |

| | | | | | | | | |
|---|--|--|----------|--|-----|-----|-------------------------------------|---|
| Table top core | chipboard | FSP | | | | • | | |
| | Medium density fibreboard (MDF) | MDF | 489 | 578 | 578 | 800 | 1066 | |
| Table top finish for chipboard core | Melamine (MFC) | 2 mm glue technology | ①/② | • | | | | |
| | Laminate | | | • | – | – | – | – |
| | Fenix NTM® | Edge: 1 mm (matching table top colour) | ① | • | | | | |
| | Veneer | | | 2 mm natural (matching table top colour) | • | • | – | – |
| Table top finish for medium density fibreboard (MDF) core | Laminate | Chamfered edge: 2 mm glue technology | ①/②-CE | • | – | – | – | – |
| | Fenix NTM® | | | 1 mm (matching table top colour) | • | | | |
| | Veneer | Chamfered edge: 2 mm natural (matching table top colour) | ①-CE | • | • | – | – | – |
| Media | No grommets / media ports | | | • | | | | |
| | 1 × Media port Netbox turn Comfort 4 M | Central position | YGO••• | See media port configuration matrix | | | – | – |
| | 2 × Media port Netbox turn Comfort 4 M | Central, left and right position | 2XYGO••• | – | – | – | See media port configuration matrix | |

* x/y mm – x: overall height/y: height under table top

① – Please specify table top colour code/solid wood colour code – see finishes

② – Please specify table top edge finish – see finishes

• Available as standard (included in basic price)

| CREVA MEETING TABLE LGW RCR | | | | | | | | |
|--------------------------------------|---|--|---------------------------|--------------|--------------|--------------|--------------|-----|
| | Width (mm) | W••• | 2400 | 3000 | 3000 | 3600 | 4200 | |
| | Depth (mm) | D••• | 1200/ 780 | 1200/ 700 | 1500/ 980 | 1500/ 950 | 1500/ 800 | |
| Base finish | Solid wood legs: | natural | BC-① | • | | | | |
| | | stained | | 22 | | | | |
| Cable management | No cable management | | • | | | | | |
| | Horizontal: | felt, grey colour | HC-KUFL1 | 199 | 304 | 304 | 349 | 349 |
| | Vertical: | upholstered, black colour | VC-U-STG60999 | 34 | | | | |
| | Horizontal: felt, grey colour | Vertical: upholstered, black colour | HC-KUFL1 VC-U-STG60999 | 233 | 338 | 338 | 383 | 383 |
| Glides | Plastic | | GD | • | | | | |
| | Plastic with felt | | GDF | ○ | | | | |
| Wood and wood-based materials | Raw material - EU Timber regulation | | EUTR | • | | | | |
| Wooden elements lacquering | Water lacquer UV | | UV | • | | | | |
| | Water lacquer | | | - 20 | | - 50 | | |
| Assembly | Partially Assembled | | ASM-P | • | | | | |
| Sample order | CREVA MEETING TABLE LGW RCR (W2400 D1200/780 FSP KNB BC-SKNB GDF EUTR UV ASM-P) | | | | | | | |

① – Please specify table top colour code/solid wood colour code – [see finishes](#)

- Available as standard (included in basic price)
- Available as an option (included in basic price)

Price list

Creva meeting table H LGW RC

Rectangular table top.
25 mm table top thickness for Melamine (MFC) finish.
27 mm table top thickness for Laminate, Veneer and Fenix finish.
Base – wooden legs.



CREVA MEETING TABLE H LGW RC

| | |
|----------------|--|
| Table top | 1-piece |
| Number of legs | 4 |
| Users | up to 6 people |
| H (mm) | 1098/1073* Melamine (MFC) 1100/1073* Fenix, Laminat, Fornir |
| WT (kg) | 54,7 |

| | | |
|----------------|------|--|
| Width (mm) | W... | 2000 |
| Depth (mm) | D... | 1000 |
| | | Basic price (EUR) according to table top finishes |
| Melamine (MFC) | | 1301 |
| Laminate | | 1858 |
| Fenix NTM® | | 2140 |
| Veneer | | 2299 |

| | | | | | |
|--|--|--|--------|--|---|
| Table top core | chipboard | | FSP | | • |
| | Medium density fibreboard (MDF) | | MDF | | 400 |
| Table top finish for chipboard core | Melamine (MFC) | 2 mm glue technology | ①② | | • |
| | Laminate | | | | • |
| | Fenix NTM® | Edge: 1 mm (matching table top colour) | ① | | • |
| | Veneer | 2 mm natural (matching table top colour) | | | • |
| Table top finish for medium density fibreboard (MDF) core | Laminate | Chamfered edge: 2 mm glue technology | ①②-CE | | • |
| | Fenix NTM® | Chamfered edge: 1 mm (matching table top colour) | ①-CE | | • |
| | Veneer | 2 mm natural (matching table top colour) | | | • |
| Media | No grommets / media ports | | | | |
| | 1 × Media port Netbox turn Comfort 4 M | Central position | YGO... | | See media port configuration matrix |

* x/y mm – x: overall height/y: height under table top

① – Please specify table top colour code/solid wood colour code – [see finishes](#)

② – Please specify table top edge finish – [see finishes](#)

• Available as standard (included in basic price)

| CREVA MEETING TABLE H LGW RC | | | | |
|--------------------------------------|--|--|---------------------------|------|
| | Width (mm) | | | 2000 |
| | Depth (mm) | | | 1000 |
| Base finish | Solid wood legs: | natural | BC-① | • |
| | | stained | | 20 |
| Cable management | No cable management | | | |
| | Horizontal: | felt, grey colour | HC-KUFL1 | 199 |
| | Vertical: | upholstered, black colour | VC-U-STG60999 | 39 |
| | Horizontal: felt, grey colour | Vertical: upholstered, black colour | HC-KUFL1 VC-U-STG60999 | 238 |
| Glides | Plastic | | GD | • |
| | Plastic with felt | | GDF | o |
| Wood and wood-based materials | Raw material - EU Timber regulation | | EUTR | • |
| Wooden elements lacquering | Water lacquer UV | | UV | • |
| | Water lacquer | | | - 20 |
| Assembly | Partially Assembled | | ASM-P | • |
| Sample order | CREVA MEETING TABLE H LGW RC (W2000 D1000 FSP KNB BC-SKNB GDF EUTR UV ASM-P) | | | |

① - Please specify table top colour code/solid wood colour code - [see finishes](#)

- Available as standard (included in basic price)
- o Available as an option (included in basic price)

Price list

Creva meeting table H LGW RCR

Soft rectangular table top with rounded edges.
 25 mm table top thickness for Melamine (MFC) finish.
 27 mm table top thickness for Laminate, Veneer and Fenix finish.
 Base – wooden legs.



CREVA MEETING TABLE H LGW RCR

| | |
|----------------|--|
| Table top | 1-piece |
| Number of legs | 4 |
| Users | up to 6 people |
| H (mm) | 1098/1073* Melamine (MFC) 1100/1073* Fenix, Laminat, Fornir |
| WT (kg) | 53,7 |

| | | |
|----------------|-------|--|
| Width (mm) | W**** | 2000 |
| Depth (mm) | D**** | 1100/800 |
| | | Basic price (EUR) according to table top finishes |
| Melamine (MFC) | | 1522 |
| Laminate | | 2174 |
| Fenix NTM® | | 2504 |
| Veneer | | 2691 |

| | | | | | |
|--|---|--|--------|--|-------------------------------------|
| Table top core | chipboard | | FSP | | • |
| | Medium density fibreboard (MDF) | | MDF | | 489 |
| Table top finish for chipboard core | Melamine (MFC) | 2 mm glue technology | ①/② | | • |
| | Laminate | | | | • |
| | Fenix NTM® | Edge: 1 mm (matching table top colour) | ① | | • |
| | Veneer | | | 2 mm natural (matching table top colour) | |
| Table top finish for medium density fibreboard (MDF) core | Laminate | Chamfered edge: 2 mm glue technology | ①/②-CE | | • |
| | Fenix NTM® | Chamfered edge: 1 mm (matching table top colour) | ①-CE | | • |
| | Veneer | | | 2 mm natural (matching table top colour) | |
| Media | No grommets / media ports | | | | • |
| | 1 × Media port Netbox turn Comfort 4 M | Central position | YGO*** | | See media port configuration matrix |

* x/y mm – x: overall height/y: height under table top

① – Please specify table top colour code/solid wood colour code – [see finishes](#)

② – Please specify table top edge finish – [see finishes](#)

• Available as standard (included in basic price)

| CREVA MEETING TABLE H LGW RC | | | |
|--------------------------------------|---|---|----------|
| | Width (mm) | | 2000 |
| | Depth (mm) | | 1100/800 |
| Base finish | Solid wood legs: | natural | • |
| | | stained | 20 |
| Cable management | No cable management | | • |
| | Horizontal: | felt, grey colour HC-KUFL1 | 199 |
| | Vertical: | upholstered, black colour VC-U-STG60999 | 39 |
| | Horizontal: felt, grey colour | Vertical: upholstered, black colour VC-U-STG60999 | 238 |
| Glides | Plastic | | • |
| | Plastic with felt | | o |
| Wood and wood-based materials | Raw material - EU Timber regulation | | • |
| Wooden elements lacquering | Water lacquer UV | | • |
| | Water lacquer | | - 20 |
| Assembly | Partially Assembled ASM-P | | • |
| Sample order | CREVA MEETING TABLE H LGW RCR (W2000 D1100/800 FSP KNB BC-SKNB GDF EUTR UV ASM-P) | | |

① – Please specify table top colour code/solid wood colour code – [see finishes](#)

- Available as standard (included in basic price)
- o Available as an option (included in basic price)

Creva meeting table LGW RCG

Rectangular table top with gap.
25 mm table top thickness for Melamine (MFC) finish.
27 mm table top thickness for Laminate, Veneer and Fenix finish.
Base – wooden legs.

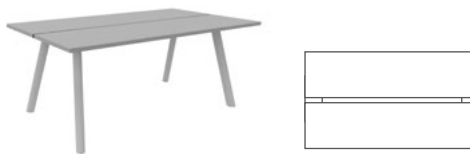

CREVA MEETING TABLE LGW RCG

| | | | | | | | | | | |
|----------------------|----------------|--|----------------|-----------------|----------------|-----------------|-----------------|-----------------|-----------------|-----------------|
| Number of table tops | Melamine (MFC) | 2 | 2 | 4 | 2 | 4 | 4 | 4 | 4 | 4 |
| | Laminate | 2 | 2 | — | 2 | — | 4 | — | 4 | 4 |
| | Fenix NTM* | 2 | 2 | 2 | 2 | 2 | 4 | 2 | 4 | 4 |
| | Veneer | 2 | 2 | — | 2 | — | 4 | — | 4 | 4 |
| Number of legs | | 4 | 4 | 4 | 4 | 4 | 6 | 4 | 6 | 6 |
| Users | | up to 6 people | up to 8 people | up to 10 people | up to 8 people | up to 10 people | up to 12 people | up to 12 people | up to 14 people | up to 16 people |
| H (mm) | | 739/714* Melamine (MFC) 741/714* Fenix, Laminat, Fornir | | | | | | | | |
| WT (kg) | | 48,3 | 59,1 | 65,7 | 67,7 | 81,0 | 102,2 | 100,5 | 127,1 | 143,1 |

| | | | | | | | | | | |
|--|------|------|------|------|------|------|------|------|------|------|
| Width (mm) | W... | 1800 | 2400 | 3000 | 2400 | 3000 | 3600 | 3000 | 3600 | 4200 |
| Depth (mm) | D... | 1000 | | | 1200 | | | 1500 | | |
| Basic price (EUR) according to table top finishes | | | | | | | | | | |
| Melamine (MFC) | | 1553 | 1881 | 1996 | 1841 | 1947 | 2567 | 2213 | 3010 | 3540 |
| Laminate | | 2104 | 2529 | — | 2629 | — | 3668 | — | 4300 | 5057 |
| Fenix NTM® | | 2562 | 3102 | 3289 | 3038 | 3211 | 4231 | 3650 | 4963 | 5836 |
| Veneer | | 2600 | 3132 | — | 3257 | — | 4541 | — | 5324 | 6261 |

| | | | | | | | | | | | |
|---|--|---|-------------------------------------|-----|-----|-----|-----|----------------|-----|----------------|------|
| Table top core | Chipboard | FSP | ● | | | | | | | | |
| | Medium density fibreboard (MDF) | MDF | 489 | 489 | 489 | 489 | 578 | 800 | 578 | 800 | 1066 |
| Table top finish for chipboard core | Melamine (MFC) | 2 mm glue technology ①② | ● | | | | | | | | |
| | Laminate | | ● | ● | — | ● | — | ● | — | ● | ● |
| | Fenix NTM® | Edge: 1 mm (matching table top colour) | ● | | | | | | | | |
| | Veneer | 2 mm natural (matching table top colour) ① | ● | ● | — | ● | — | ● | — | ● | ● |
| Table top finish for medium density fibreboard (MDF) core | Laminate | Chamfered edge: 2 mm glue technology ①②-CE | ● | ● | — | ● | — | ● | — | ● | ● |
| | Fenix NTM® | 1 mm (matching table top colour) | ● | | | | | | | | |
| | Veneer | Chamfered edge: 2 mm natural (matching table top colour) ①-CE | ● | ● | — | ● | — | ● | — | ● | ● |
| No grommets / media ports | | | ● | | | | | | | | |
| Media | 1 × Media port W-Box PIP adjustable position | YKUO... | See media port configuration matrix | | | | — | See media port | — | — | |
| | 2 × Media port W-Box PIP adjustable position | YKUO.../YKUO... | — | — | — | — | — | See media port | — | See media port | |

* x/y mm – x: overall height/y: height under table top

① – Please specify table top colour code/solid wood colour code – see finishes

② – Please specify table top edge finish – see finishes

● Available as standard (included in basic price)

| | | | CREVA MEETING TABLE LGW RCG | | | | | | | | | |
|--------------------------------------|---|-------------------------------------|---------------------------------------|------|------|------|------|------|------|------|------|------|
| Width (mm) | | | 1800 | 2400 | 3000 | 2400 | 3000 | 3600 | 3000 | 3600 | 4200 | |
| Depth (mm) | | | 1000 | | | 1200 | | | 1500 | | | |
| Base finish | Solid wood legs: | natural | • | | | | | | | | | |
| | | stained | | | | | | | | | | BC-① |
| | | | 15 | 15 | 15 | 15 | 15 | 22 | 15 | 22 | 22 | |
| Cable management | No cable management | | • | | | | | | | | | |
| | Horizontal: | felt, grey colour | HC-KUFL1 | 189 | 199 | 216 | 199 | 216 | 260 | 216 | 260 | 349 |
| | Vertical: | upholstered, black colour | VC-U-STG60999 | 34 | | | | | | | | |
| | Horizontal: felt, grey colour | Vertical: upholstered, black colour | HC-KUFL1 VC-U-STG60999 HC-KUFL1 | 223 | 233 | 250 | 233 | 250 | 294 | 250 | 294 | 383 |
| Glides | Plastic | | • | | | | | | | | | |
| | Plastic with felt | | ○ | | | | | | | | | |
| Upper panel | No upper panel | | • | | | | | | | | | |
| | 1 × panel, upholstered, adjustable position Width: 910 mm, Height: 390 mm | Price group: | 2 | 345 | 345 | 345 | 345 | 345 | — | 345 | — | — |
| | | | 3 | 367 | 367 | 367 | 367 | 367 | — | 367 | — | — |
| | | | 4 | 398 | 398 | 398 | 398 | 398 | — | 398 | — | — |
| | | | 5 | 420 | 420 | 420 | 420 | 420 | — | 420 | — | — |
| | 2 × panel, upholstered, adjustable position Width: 910 mm, Height: 390 mm | Price group: | 2 | — | — | — | — | — | 689 | — | 689 | 689 |
| | | | 3 | — | — | — | — | — | 734 | — | 734 | 734 |
| | | | 4 | — | — | — | — | — | 796 | — | 796 | 796 |
| | | | 5 | — | — | — | — | — | 839 | — | 839 | 839 |
| | Wooden tray (matching base finish) | No wooden tray | | • | | | | | | | | |
| Wooden tray, adjustable position | | natural | 125 | | | | | | | | | |
| | | Solid wood: stained | TR-KU1-① | 134 | | | | | | | | |
| Wood and wood-based materials | Raw material - EU Timber regulation | | • | | | | | | | | | |
| Wooden elements lacquering | Water lacquer UV | | • | | | | | | | | | |
| | Water lacquer | | -20 | -20 | -20 | -20 | -20 | -50 | -20 | -50 | -50 | |
| Assembly | Partially Assembled | | • | | | | | | | | | |
| Sample order | CREVA MEETING TABLE LGW RCG (W1800 D1000 FSP KNB BC-SKNB GDF EUTR UV ASM-P) | | | | | | | | | | | |

① – Please specify table top colour code/solid wood colour code – [see finishes](#)

⑤ – Please specify upholstery colour code from selected price group – [see finishes](#)

• Available as standard (included in basic price)

○ Available as an option (included in basic price)

Price list

Creva meeting table LGW RCRG

Soft rectangular table top with rounded edges and gap.
25 mm table top thickness for Melamine (MFC) finish.
27 mm table top thickness for Laminate, Veneer and Fenix finish.
Base – wooden legs.



CREVA MEETING TABLE LGW RCRG

| | | | | | | |
|----------------------|----------------|--|-----------------|-----------------|-----------------|-----------------|
| Number of table tops | Melamine (MFC) | 2 | 4 | 4 | 4 | 4 |
| | Laminate | 2 | — | — | 4 | 4 |
| | Fenix NTM* | 2 | 2 | 2 | 4 | 4 |
| | Veneer | 2 | — | — | 4 | 4 |
| Number of legs | | 4 | 4 | 4 | 6 | 6 |
| Users | | up to 8 people | up to 10 people | up to 10 people | up to 12 people | up to 14 people |
| H (mm) | | 739/714* Melamine (MFC) 741/714* Fenix, Laminat, Fornir | | | | |
| WT (kg) | | 61,8 | 73,2 | 89,5 | 113,3 | 127,3 |

| | | | | | | |
|----------------|------|--|--------------|--------------|--------------|--------------|
| Width (mm) | W... | 2400 | 3000 | 3000 | 3600 | 4200 |
| Depth (mm) | D... | 1200/ 780 | 1200/ 700 | 1500/ 980 | 1500/ 950 | 1500/ 800 |
| | | Basic price (EUR) according to table top finishes | | | | |
| Melamine (MFC) | | 2287 | 2425 | 2756 | 3747 | 4411 |
| Laminate | | 3281 | — | — | 5354 | 6303 |
| Fenix NTM® | | 3782 | 4005 | 4547 | 6180 | 7266 |
| Veneer | | 4060 | — | — | 6633 | 7802 |

| | | | | | | | | |
|---|---------------------------------|--|-----------------|---|-----|-----|--------------------------------|------|
| Table top core | Chipboard | | FSP | • | | | | |
| | Medium density fibreboard (MDF) | | MDF | 622 | 622 | 755 | 1021 | 1199 |
| Table top finish for chipboard core | Melamine (MFC) | 2 mm glue technology | ①② | • | | | | |
| | Laminate | | | • | — | — | • | • |
| | Fenix NTM® | Edge: 1 mm (matching table top colour) | ① | • | | | | |
| | Veneer | 2 mm natural (matching table top colour) | | • | — | — | • | • |
| Table top finish for medium density fibreboard (MDF) core | Laminate | Chamfered edge: 2 mm glue technology | ①②-CE | • | — | — | • | • |
| | Fenix NTM® | Chamfered edge: 1 mm (matching table top colour) | | ①-CE | • | | | |
| | Veneer | 2 mm natural (matching table top colour) | • | | — | — | • | • |
| Media | No grommets / media ports | | | • | | | | |
| | 1 × Media port W-Box PIP | adjustable position | YKUO... | See media port configuration matrix | | | | |
| | 2 × Media port W-Box PIP | adjustable position | YKUO.../YKUO... | — | — | — | See media port | |

* x/y mm – x: overall height/y: height under table top

① – Please specify table top colour code/solid wood colour code – [see finishes](#)

② – Please specify table top edge finish – [see finishes](#)

• Available as standard (included in basic price)

| | | | | CREVA MEETING TABLE LGW RCRG | | | | |
|---|--|---------------------------|---------------------------------------|------------------------------|--------------|--------------|--------------|--------------|
| Width (mm) | | | | 2400 | 3000 | 3000 | 3600 | 4200 |
| Depth (mm) | | | | 1200/ 780 | 1200/ 700 | 1500/ 980 | 1500/ 950 | 1500/ 800 |
| Base finish | Solid wood legs: | natural | BC-① | • | | | | |
| | | stained | | 15 | 15 | 15 | 22 | 22 |
| Cable management | No cable management | | | • | | | | |
| | Horizontal: | felt, grey colour | HC-KUFL1 | 199 | 304 | 304 | 260 | 349 |
| | Vertical: | upholstered, black colour | VC-U-STG60999 | 34 | | | | |
| | Horizontal: | Vertical: | HC-KUFL1 VC-U-STG60999 HC-KUFL1 | 233 | 338 | 338 | 294 | 383 |
| Glides | Plastic | | | • | | | | |
| | Plastic with felt | | | ○ | | | | |
| Upper panel | No upper panel | | | • | | | | |
| | 1 × panel, upholstered, adjustable position Width: 910 mm, Height: 390 mm | Price group: | 2 | 345 | 345 | 345 | — | — |
| | | | 3 | 367 | 367 | 367 | — | — |
| | | | 4 | 398 | 398 | 398 | — | — |
| | | | 5 | 420 | 420 | 420 | — | — |
| | 2 × panel, upholstered, adjustable position Width: 910 mm, Height: 390 mm | Price group: | 2 | — | — | — | 689 | 689 |
| | | | 3 | — | — | — | 734 | 734 |
| | | | 4 | — | — | — | 796 | 796 |
| 5 | | | — | — | — | 839 | 839 | |
| Wooden tray (matching base finish) | No wooden tray | | | • | | | | |
| | Wooden tray, adjustable position | Solid wood: | natural | 125 | | | | |
| stained | | | 134 | | | | | |
| Wood and wood-based materials | Raw material - EU Timber regulation | | | • | | | | |
| Wooden elements lacquering | Water lacquer UV | | | • | | | | |
| | Water lacquer | | | -20 | -20 | -20 | -50 | -50 |
| Assembly | Partially Assembled | | | • | | | | |
| Sample order | CREVA MEETING TABLE LGW RCRG (W2400 D1200/780 FSP KNB BC-SKNB GDF EUTR UV ASM-P) | | | | | | | |

① - Please specify table top colour code/solid wood colour code - [see finishes](#)

⑤ - Please specify upholstery colour code from selected price group - [see finishes](#)

• Available as standard (included in basic price)

○ Available as an option (included in basic price)

Price list

Creva meeting table H LGW RCG

Rectangular table top with gap.
25 mm table top thickness for Melamine (MFC) finish.
27 mm table top thickness for Laminate, Veneer and Fenix finish.
Base – wooden legs.



CREVA MEETING TABLE H LGW RCG

| | |
|----------------|--|
| Table top | 2-piece |
| Number of legs | 4 |
| Users | up to 6 people |
| H (mm) | 1098/1073* Melamine (MFC) 1100/1073* Fenix, Laminat, Fornir |
| WT (kg) | 54,7 |

| | | |
|--|------|------|
| Width (mm) | W... | 2000 |
| Depth (mm) | D... | 1000 |
| Basic price (EUR) according to table top finishes | | |
| Melamine (MFC) | | 1691 |
| Laminate | | 2414 |
| Fenix NTM® | | 2782 |
| Veneer | | 2986 |

| | | | | |
|--|---------------------------------|--|---------|---|
| Table top core | Chipboard | | FSP | • |
| | Medium density fibreboard (MDF) | | MDF | 489 |
| Table top finish for chipboard core | Melamine (MFC) | 2 mm glue technology | ①/② | • |
| | Laminate | | | • |
| | Fenix NTM® | Edge: 1 mm (matching table top colour) | ① | • |
| | Veneer | 2 mm natural (matching table top colour) | ① | • |
| Table top finish for medium density fibreboard (MDF) core | Laminate | Chamfered edge: 2 mm glue technology | ①/②-CE | • |
| | Fenix NTM® | Chamfered edge: 1 mm (matching table top colour) | ①-CE | • |
| | Veneer | 2 mm natural (matching table top colour) | ①-CE | • |
| Media (wooden box matching base finish) | No grommets / media ports | | | • |
| | 1 × Media port W-Box PIP | adjustable position | YKUO... | See media port configuration matrix |
| Base finish | Solid wood legs: | natural | BC-① | • |
| | | stained | | 20 |

* x/y mm – x: overall height/y: height under table top

① – Please specify table top colour code / solid wood colour code – [see finishes](#)

② – Please specify table top edge finish – [see finishes](#)

• Available as standard (included in basic price)

| | | | | CREVA MEETING TABLE LGW RCRG |
|---|---|---------------------------|---------------------------------------|------------------------------|
| | Width (mm) | | | 2000 |
| | Depth (mm) | | | 1000 |
| Cable management | No cable management | | | |
| | Horizontal: | felt, grey colour | HC-KUFL1 | 199 |
| | Vertical: | upholstered, black colour | VC-U-STG60999 | 39 |
| | Horizontal: | Vertical: | HC-KUFL1 VC-U-STG60999 HC-KUFL1 | 238 |
| Glides | Plastic | | GD | • |
| | Plastic with felt | | GDF | ◦ |
| Upper panel | No upper panel | | | • |
| | Panel, upholstered, adjustable position Width: 910 mm, Height: 390 mm | Price group: | 2 | 345 |
| | | | 3 | 367 |
| | | | 4 | 398 |
| | | | 5 | 420 |
| | | U-KUU1-⑤ | | |
| Wooden tray (matching base finish) | No wooden tray | | | • |
| | Wooden tray, adjustable position | Solid wood: | natural stained | TR-KU1-① |
| | | | | 125 |
| | | | | 134 |
| Wood and wood-based materials | Raw material - EU Timber regulation | | EUTR | • |
| Wooden elements lacquering | Water lacquer UV | | UV | • |
| | Water lacquer | | | - 20 |
| Assembly | Partially Assembled | | ASM-P | • |
| Sample order | CREVA MEETING TABLE H LGW RCG (W2000 D1000 FSP KNB BC-SKNB GDF EUTR UV ASM-P) | | | |

- ① – Please specify table top colour code/solid wood colour code – [see finishes](#)
- ⑤ – Please specify upholstery colour code from selected price group – [see finishes](#)

- Available as standard (included in basic price)
- Available as an option (included in basic price)

Price list

Creva meeting table H LGW RCRG

Soft rectangular table top with rounded edges and gap.
25 mm table top thickness for Melamine (MFC) finish.
27 mm table top thickness for Laminate, Veneer and Fenix finish.
Base – wooden legs.



CREVA MEETING TABLE H LGW RCRG

| | |
|----------------|---|
| Table top | 2-piece |
| Number of legs | 4 |
| Users | up to 6 people |
| H (mm) | 1098/1073* Melamine (MFC) 1100/1073* Fenix, Laminate, Fornir |
| WT (kg) | 53,8 |

| | | |
|--|------|----------|
| Width (mm) | W... | 2000 |
| Depth (mm) | D... | 1100/800 |
| Basic price (EUR) according to table top finishes | | |
| Melamine (MFC) | | 1979 |
| Laminate | | 2827 |
| Fenix NTM® | | 3254 |
| Veneer | | 3498 |

| | | | | | |
|--|---------------------------------|--|----------------------------------|--------|---|
| Table top core | Chipboard | | FSP | | • |
| | Medium density fibreboard (MDF) | | MDF | | 622 |
| Table top finish for chipboard core | Melamine (MFC) | 2 mm glue technology | ①/② | | • |
| | Laminate | Edge: | | | • |
| | Fenix NTM® | 1 mm (matching table top colour) | ① | | • |
| | Veneer | 2 mm natural (matching table top colour) | | | • |
| Table top finish for medium density fibreboard (MDF) core | Laminate | Chamfered edge: | 2 mm glue technology | ①/②-CE | • |
| | Fenix NTM® | Chamfered edge: | 1 mm (matching table top colour) | ①-CE | • |
| | Veneer | 2 mm natural (matching table top colour) | | | • |
| Media (wooden box matching base finish) | No grommets / media ports | | | | • |
| | 1 × Media port W-Box PIP | adjustable position | YKUO... | | See media port configuration matrix |
| Base finish | Solid wood legs: | natural | | | • |
| | | stained | BC-① | | 20 |

* x/y mm – x: overall height/y: height under table top

① – Please specify table top colour code/solid wood colour code – [see finishes](#)

② – Please specify table top edge finish – [see finishes](#)

• Available as standard (included in basic price)

| | | | | CREVA MEETING TABLE H LGW RCRG |
|---|--|---------------------------|---------------------------------------|--------------------------------|
| | Width (mm) | | | 2000 |
| | Depth (mm) | | | 1100/800 |
| Cable management | No cable management | | | |
| | Horizontal: | felt, grey colour | HC-KUFL1 | 199 |
| | Vertical: | upholstered, black colour | VC-U-STG60999 | 39 |
| | Horizontal: | Vertical: | HC-KUFL1 VC-U-STG60999 HC-KUFL1 | 238 |
| Glides | Plastic | | GD | • |
| | Plastic with felt | | GDF | ◦ |
| Upper panel | No upper panel | | | • |
| | Panel, upholstered, adjustable position Width: 910 mm, Height: 390 mm | Price group: | 2 | 345 |
| | | | 3 | 367 |
| | | | 4 | 398 |
| | | | 5 | 420 |
| Wooden tray (matching base finish) | No wooden tray | | | • |
| | Wooden tray, adjustable position | Solid wood: | natural stained | TR-KU1-① |
| Wood and wood-based materials | Raw material - EU Timber regulation | | | EUTR |
| Wooden elements lacquering | Water lacquer UV | | | UV |
| | Water lacquer | | | - 20 |
| Assembly | Partially Assembled | | | ASM-P |
| Sample order | CREVA MEETING TABLE H LGW RCRG (W2000 D1100/800 FSP KNB BC-SKNB GDF EUTR UV ASM-P) | | | |

- ① - Please specify table top colour code/solid wood colour code - [see finishes](#)
- ⑤ - Please specify upholstery colour code from selected price group - [see finishes](#)

- Available as standard (included in basic price)
- Available as an option (included in basic price)

Price list

Creva meeting table LGM SQ

Square table top.
25 mm table top thickness for Melamine (MFC) finish.
27 mm table top thickness for Laminate, Veneer and Fenix finish.
Base – metal legs.



CREVA MEETING TABLE LGM SQ

| | | |
|----------------|--|------|
| Table top | 1-piece | |
| Number of legs | 4 | |
| Users | up to 4 people | |
| H (mm) | 739/714* Melamine (MFC) 741/714* Fenix, Laminat, Fornir | |
| WT (kg) | 42,3 | 57,1 |

| | | | |
|--|------|------|------|
| Width (mm) | W... | 1200 | 1500 |
| Depth (mm) | D... | 1200 | 1500 |
| Basic price (EUR) according to table top finishes | | | |
| Melamine (MFC) | | 706 | 979 |
| Laminate | | 1181 | — |
| Fenix NTM® | | 1424 | 1874 |
| Veneer | | 1557 | — |

| | | | |
|--|-------------------------------------|--|--------|
| Table top core | Chipboard | FSP | • |
| | Medium density fibreboard (MDF) | MDF | 312 |
| Table top finish for chipboard core | Melamine (MFC) | 2 mm glue technology | ①/② |
| | Laminate | Edge: | • |
| | Fenix NTM® | 1 mm (matching table top colour) | ① |
| | Veneer | 2 mm natural (matching table top colour) | • |
| Table top finish for medium density fibreboard (MDF) core | Laminate | 2 mm glue technology | ①/②-CE |
| | Fenix NTM® | Chamfered edge: 1 mm (matching table top colour) | ①-CE |
| | Veneer | 2 mm natural (matching table top colour) | • |
| Base finish | Metal legs: | powder coated | BC-③ |
| | | chromium plated | 100 |
| Glides | Plastic | GD | • |
| | Plastic with felt | GDF | ○ |
| Wood and wood-based materials | Raw material - EU Timber regulation | EUTR | • |
| Assembly | Partially Assembled | ASM-P | • |

Sample order CREVA MEETING TABLE LGM SQ (W1200 D1200 FSP KNB BC-BK GDF EUTR ASM-P)

* x/y mm – x: overall height/y: height under table top

① – Please specify table top colour code/solid wood colour code – [see finishes](#)

② – Please specify table top edge finish – [see finishes](#)

③ – Please specify metal colour code – [see finishes](#)

• Available as standard (included in basic price)

○ Available as an option (included in basic price)

Creva meeting table LGM RC

Rectangular table top.
25 mm table top thickness for Melamine (MFC) finish.
27 mm table top thickness for Laminate, Veneer and Fenix finish.
Base – metal legs.



CREVA MEETING TABLE LGM RC

| | | | | | | | | | | |
|----------------------|--|----------------|-----------------|----------------|-----------------|-----------------|-----------------|-----------------|-------|---|
| Number of table tops | Melamine (MFC) | 1 | 1 | 2 | 1 | 2 | 2 | 2 | 2 | 2 |
| | Laminate | 1 | 1 | – | 1 | – | 2 | – | – | – |
| | Fenix NTM® | 1 | 1 | 1 | 1 | 1 | 2 | 1 | 2 | 2 |
| | Veneer | 1 | 1 | 2 | 1 | 2 | 2 | – | – | – |
| Number of legs | 4 | 4 | 4 | 4 | 4 | 6 | 4 | 6 | 6 | |
| Users | up to 6 people | up to 8 people | up to 10 people | up to 8 people | up to 10 people | up to 12 people | up to 14 people | up to 16 people | | |
| H (mm) | 739/714* Melamine (MFC) 741/714* Fenix, Laminat, Fornir | | | | | | | | | |
| WT (kg) | 48,1 | 59,1 | 70,3 | 67,7 | 81,1 | 101,9 | 100,9 | 113,9 | 143,4 | |

| | | | | | | | | | | | |
|----------------|------|--|------|------|------|------|------|------|------|------|--|
| Width (mm) | W... | 1800 | 2400 | 3000 | 2400 | 3000 | 3600 | 3000 | 3600 | 4200 | |
| Depth (mm) | D... | 1000 | | | 1200 | | | 1500 | | | |
| | | Basic price (EUR) according to table top finishes | | | | | | | | | |
| Melamine (MFC) | | 901 | 1167 | 1263 | 1136 | 1224 | 1540 | 1445 | 1908 | 2350 | |
| Laminate | | 1352 | 1709 | – | 1793 | – | 2457 | – | – | – | |
| Fenix NTM® | | 1743 | 2184 | 2340 | 2132 | 2278 | 2928 | 2641 | 3536 | 4263 | |
| Veneer | | 1768 | 2210 | 2365 | 2316 | 2470 | 3184 | – | – | – | |

| | | | | | | | | | | | | |
|---|---|--|----------|-----|-----|-----|-----|-----|-----|----------------|-----|----------------|
| Table top core | Chipboard | FSP | | | | | | | | | | |
| | Medium density fibreboard (MDF) | MDF | 425 | 425 | 425 | 400 | 534 | 534 | 534 | 711 | 933 | |
| Table top finish for chipboard core | Melamine (MFC) | 2 mm glue technology | ① | ② | | | | | | | | |
| | Laminate | Edge: | • | • | – | • | – | • | – | – | – | |
| | Fenix NTM® | 1 mm (matching table top colour) | ① | | | | | | | | | |
| | Veneer | 2 mm natural (matching table top colour) | • | • | • | • | • | • | – | – | – | |
| Table top finish for medium density fibreboard (MDF) core | Laminate | Chamfered edge: | ① | ② | –CE | • | • | – | • | – | – | |
| | Fenix NTM® | Chamfered edge: | ① | –CE | | | | | | | | |
| | Veneer | 2 mm natural (matching table top colour) | • | • | • | • | • | • | – | – | – | |
| Media | No grommets / media ports | | | | | | | | | | | |
| | 1 × Media port Netbox turn Comfort 4 M | Central position | YGO... | | | | | | – | See media port | – | – |
| | 2 × Media port Netbox turn Comfort 4 M | Central left and right position | 2XYGO... | – | – | – | – | – | – | See media port | – | See media port |

* x/y mm – x: overall height/y: height under table top

① – Please specify table top colour code/solid wood colour code – [see finishes](#)

② – Please specify table top edge finish – [see finishes](#)

③ – Please specify metal colour code – [see finishes](#)

• Available as standard (included in basic price)

Price list

| GREVA MEETING TABLE LGM RC | | | | | | | | | | | | | | |
|--------------------------------------|-------------------------------------|---|-------------------|---------------------------|----------|---------------|------|------|------|------|------|-----|-----|-----|
| Width (mm) | | W... | 1800 | 2400 | 3000 | 2400 | 3000 | 3600 | 3000 | 3600 | 4200 | | | |
| Depth (mm) | | D... | 1000 | | | 1200 | | | 1500 | | | | | |
| Base finish | Metal legs: | powder coated | BC-③ | | | | | | | | | | | |
| | | chromium plated | | | | | | | | | | | | |
| | | | 100 | 100 | 100 | 100 | 100 | 150 | 100 | 150 | 150 | | | |
| Cable management | No cable management | | • | | | | | | | | | | | |
| | Horizontal: | felt, grey colour | HC-KUFL1 | 201 | 211 | 323 | 199 | 304 | 349 | 304 | 349 | 349 | | |
| | Vertical: | upholstered, black colour | VC-U-STG60999 | 34 | | | | | | | | | | |
| | Horizontal: | Vertical: | felt, grey colour | upholstered, black colour | HC-KUFL1 | VC-U-STG60999 | 235 | 245 | 357 | 233 | 338 | 383 | 338 | 383 |
| Glides | Plastic | | GD | | | | | | | | | | | |
| | Plastic with felt | | GDF | | | | | | | | | | | |
| Wood and wood-based materials | Raw material - EU Timber regulation | | EUTR | | | | | | | | | | | |
| | Assembly | | ASM-P | | | | | | | | | | | |
| Sample order | | CREVA MEETING TABLE LGM RC (W1800 D1000 FSP KNB BC-BK GDF EUTR ASM-P) | | | | | | | | | | | | |

③ – Please specify metal colour code – [see finishes](#)

- Available as standard (included in basic price)
- Available as an option (included in basic price)

Creva meeting table LGM RD

Round table top.
25 mm table top thickness for Melamine (MFC) finish.
27 mm table top thickness for Laminate, Veneer and Fenix finish.
Base – metal legs.



CREVA MEETING TABLE LGM RD

| | | |
|----------------|--|----------------|
| Table top | 1-piece | 1-piece |
| Number of legs | 4 | 4 |
| Users | up to 4 people | up to 4 people |
| H (mm) | 739/714* Melamine (MFC) 741/714* Fenix, Laminat, Fornir | |
| WT (kg) | 35,0 | 46,7 |

| | | | |
|--|------|------|------|
| Diameter (mm) | D... | 1200 | 1500 |
| Basic price (EUR) according to table top finishes | | | |
| Melamine (MFC) | | 573 | 807 |
| Laminate | | 990 | – |
| Fenix NTM® | | 1207 | 1593 |
| Veneer | | 1322 | – |

| | | | | | |
|--|-------------------------------------|--|--------|--|-----|
| Table top core | chipboard | | FSP | | • |
| | Medium density fibreboard (MDF) | | MDF | | 312 |
| Table top finish for chipboard core | Melamine (MFC) | | | | • |
| | Laminate | 2 mm glue technology | ①/② | | • |
| | Fenix NTM® | Edge: 1 mm (matching table top colour) | ① | | • |
| | Veneer | 2 mm natural (matching table top colour) | | | • |
| Table top finish for medium density fibreboard (MDF) core | Laminate | Chamfered edge: 2 mm glue technology | ①/②-CE | | • |
| | Fenix NTM® | Chamfered edge: 1 mm (matching table top colour) | ①-CE | | • |
| | Veneer | 2 mm natural (matching table top colour) | | | • |
| Base finish | Metal legs: | powder coated | | | • |
| | | chromium plated | BC-③ | | 100 |
| Glides | Plastic | | GD | | • |
| | Plastic with felt | | GDF | | ○ |
| Wood and wood-based materials | Raw material - EU Timber regulation | | EUTR | | • |
| Assembly | Partially Assembled | | ASM-P | | • |

Sample order CREVA MEETING TABLE LGM RD (D1200 FSP KNB BC-BK GDF EUTR ASM-P)

* x/y mm – x: overall height/y: height under table top

① – Please specify table top colour code/solid wood ccolour code – [see finishes](#)

② – Please specify table top edge finish – [see finishes](#)

③ – Please specify metal colour code – [see finishes](#)

• Available as standard (included in basic price)

○ Available as an option (included in basic price)

Price list

CREVA meeting table LGM RCR

Soft rectangular table top with rounded edges.
25 mm table top thickness for Melamine (MFC) finish.
27 mm table top thickness for Laminate, Veneer and Fenix finish.
Base – metal legs.



CREVA MEETING TABLE LGM RCR

| | | | | | | |
|----------------------|------------|--|-----------------|-----------------|-----------------|-----------------|
| Number of table tops | Laminate | 1 | 2 | 2 | 2 | 2 |
| | Fenix NTM® | 1 | 1 | 1 | 2 | 2 |
| | Veneer | 1 | 2 | – | – | – |
| Number of legs | | 4 | 4 | 4 | 6 | 6 |
| Users | | up to 8 people | up to 10 people | up to 12 people | up to 12 people | up to 14 people |
| H (mm) | | 739/714* Melamine (MFC) 741/714* Fenix, Laminat, Fornir | | | | |
| WT (kg) | | 61,6 | 73,2 | 82,9 | 112,6 | 127,0 |

| | | | | | | |
|----------------|-------|--|--------------|--------------|--------------|--------------|
| Width (mm) | W•••• | 2400 | 3000 | 3000 | 3600 | 4200 |
| Depth (mm) | D•••• | 1200/ 780 | 1200/ 700 | 1500/ 980 | 1500/ 950 | 1500/ 800 |
| | | Basic price (EUR) according to table top finishes | | | | |
| Melamine (MFC) | | 1367 | 1466 | 1722 | 2284 | 2793 |
| Laminate | | 2125 | – | – | – | – |
| Fenix NTM® | | 2509 | 2679 | 3099 | 4154 | 4990 |
| Veneer | | 2721 | 2902 | – | – | – |

| | | | | | | | | |
|---|--|--|----------|--|-----|-----|-------------------------------------|---|
| Table top core | chipboard | FSP | | | | • | | |
| | Medium density fibreboard (MDF) | MDF | 489 | 578 | 578 | 800 | 1066 | |
| Table top finish for chipboard core | Melamine (MFC) | Edge: 2 mm glue technology | ①/② | | | | • | |
| | Laminate | | | • | – | – | – | – |
| | Fenix NTM® | Edge: 1 mm (matching table top colour) | ① | | | | • | |
| | Veneer | | | 2 mm natural (matching table top colour) | • | • | – | – |
| Table top finish for medium density fibreboard (MDF) core | Laminate | Chamfered edge: 2 mm glue technology | ①/②-CE | • | – | – | – | – |
| | Fenix NTM® | Chamfered edge: 1 mm (matching table top colour) | ①-CE | | | | • | |
| | Veneer | | | 2 mm natural (matching table top colour) | • | • | – | – |
| Media | No grommets / media ports | | | | | | • | |
| | 1 × Media port Netbox turn Comfort 4 M | Central position | YGO••• | See media port configuration matrix | | | – | – |
| | 2 × Media port Netbox turn Comfort 4 M | Central, left and right position | 2XYGO••• | – | – | – | See media port configuration matrix | |
| Base finish | Metal legs: | powder coated | BC-③ | | | | • | |
| | | chromium plated | | | 100 | | 150 | |

* x/y mm – x: overall height/y: height under table top

① – Please specify table top colour code/solid wood colour code – see finishes

② – Please specify table top edge finish – see finishes

③ – Please specify metal colour code – see finishes

• Available as standard (included in basic price)

CREVA MEETING TABLE LGM RCR

| | | | | | | | | |
|--------------------------------------|--|--|---------------------------|--------------|--------------|--------------|--------------|-----|
| | Width (mm) | W•••• | 2400 | 3000 | 3000 | 3600 | 4200 | |
| | Depth (mm) | D•••• | 1200/ 780 | 1200/ 700 | 1500/ 980 | 1500/ 950 | 1500/ 800 | |
| Cable management | No cable management | | | | • | | | |
| | Horizontal: | felt, grey colour | HC-KUFL1 | 199 | 304 | 304 | 349 | 349 |
| | Vertical: | upholstered, black colour | VC-U-STG60999 | | | 34 | | |
| | Horizontal: felt, grey colour | Vertical: upholstered, black colour | HC-KUFL1 VC-U-STG60999 | 233 | 338 | 338 | 383 | 383 |
| Glides | Plastic | | GD | | | • | | |
| | Plastic with felt | | GDF | | | ◦ | | |
| Wood and wood-based materials | Raw material - EU Timber regulation | | EUTR | | | • | | |
| Assembly | Partially Assembled | | ASM-P | | | • | | |
| Sample order | CREVA MEETING TABLE LGM RCR (W2400 D1200/780 FSP KNB BC-BK GDF EUTR ASM-P) | | | | | | | |

- Available as standard (included in basic price)
- Available as an option (included in basic price)

Price list

Creva meeting table H LGM RC

Rectangular table top.
25 mm table top thickness for Melamine (MFC) finish.
27 mm table top thickness for Laminate, Veneer and Fenix finish.
Base – metal legs.



CREVA MEETING TABLE H LGM RC

| | | | |
|---|--|---|---|
| Table top | 1-piece | | |
| Number of legs | 4 | | |
| Users | up to 6 people | | |
| H (mm) | 1098/1073* Melamine (MFC) 1100/1073* Fenix, Laminat, Fornir | | |
| WT (kg) | 54,7 | | |
| Basic price (EUR) according to table top finishes | | | |
| Melamine (MFC) | 901 | | |
| Laminate | 1458 | | |
| Fenix NTM® | 1740 | | |
| Veneer | 1899 | | |
| Width (mm) | W... | 2000 | |
| Depth (mm) | D... | 1000 | |
| Table top core | chipboard | FSP | • |
| | Medium density fibreboard (MDF) | MDF | 400 |
| Table top finish for chipboard core | Melamine (MFC) | 2 mm glue technology | ①/② |
| | Laminate | | |
| | Fenix NTM® | Edge: 1 mm (matching table top colour) | ① |
| | Veneer | 2 mm natural (matching table top colour) | |
| Table top finish for medium density fibreboard (MDF) core | Laminate | Chamfered edge: 2 mm glue technology | ①/②-CE |
| | Fenix NTM® | Chamfered edge: 1 mm (matching table top colour) | ①-CE |
| | Veneer | 2 mm natural (matching table top colour) | |
| Media | No grommets / media ports | | |
| | 1 × Media port Netbox turn Comfort 4 M | Central position | YGO... See media port configuration matrix |
| Base finish | Metal legs: | powder coated | • |
| | | chromium plated | BC-③ 100 |

* x/y mm – x: overall height/y: height under table top

① – Please specify table top colour code/solid wood colour code – [see finishes](#)

② – Please specify table top edge finish – [see finishes](#)

③ – Please specify metal colour code – [see finishes](#)

• Available as standard (included in basic price)

| | | | | CREVA MEETING TABLE H LGM RC |
|--------------------------------------|---|--|---------------------------|------------------------------|
| | Width (mm) | | | 2000 |
| | Depth (mm) | | | 1000 |
| Cable management | No cable management | | | • |
| | Horizontal: | felt, grey colour | HC-KUFL1 | 199 |
| | Vertical: | upholstered, black colour | VC-U-STG60999 | 39 |
| | Horizontal: felt, grey colour | Vertical: upholstered, black colour | HC-KUFL1 VC-U-STG60999 | 238 |
| Glides | Plastic | | | • |
| | Plastic with felt | | | ○ |
| Wood and wood-based materials | Raw material - EU Timber regulation | | | • |
| | EUTR | | | |
| Assembly | Partially Assembled | | | • |
| ASM-P | | | | |
| Sample order | CREVA MEETING TABLE H LGM RC (W2000 D1000 FSP KNB BC-BK GDF EUTR ASM-P) | | | |

- Available as standard (included in basic price)
- Available as an option (included in basic price)

Creva meeting table H LGM RCR

Soft rectangular table top with rounded edges.
25 mm table top thickness for Melamine (MFC) finish.
27 mm table top thickness for Laminate, Veneer and Fenix finish.
Base – metal legs.



CREVA MEETING TABLE H LGM RCR

| | |
|----------------|--|
| Table top | 1-piece |
| Number of legs | 4 |
| Users | up to 6 people |
| H (mm) | 1098/1073* Melamine (MFC) 1100/1073* Fenix, Laminat, Fornir |
| WT (kg) | 53,7 |

| | | |
|--|-------|----------|
| Width (mm) | W**** | 2000 |
| Depth (mm) | D**** | 1100/800 |
| Basic price (EUR) according to table top finishes | | |
| Melamine (MFC) | | 1122 |
| Laminate | | 1774 |
| Fenix NTM® | | 2104 |
| Veneer | | 2291 |

| | | | | | |
|--|---|--|--------|--|-------------------------------------|
| Table top core | chipboard | | FSP | | • |
| | Medium density fibreboard (MDF) | | MDF | | 489 |
| Table top finish for chipboard core | Melamine (MFC) | 2 mm glue technology | ①/② | | • |
| | Laminate | | | | • |
| | Fenix NTM® | Edge: 1 mm (matching table top colour) | ① | | • |
| | Veneer | | | 2 mm natural (matching table top colour) | |
| Table top finish for medium density fibreboard (MDF) core | Laminate | Chamfered edge: 2 mm glue technology | ①/②-CE | | • |
| | Fenix NTM® | | | 1 mm (matching table top colour) | |
| | Veneer | Chamfered edge: 2 mm natural (matching table top colour) | ①-CE | | • |
| Media | No grommets / media ports | | | | • |
| | 1 × Media port Netbox turn Comfort 4 M | Central position | YGO*** | | See media port configuration matrix |
| Base finish | Metal legs: | powder coated | BC-③ | | • |
| | | chromium plated | | | 100 |

* x/y mm – x: overall height/y: height under table top

① – Please specify table top colour code/solid wood colour code – [see finishes](#)

② – Please specify table top edge finish – [see finishes](#)

③ – Please specify metal colour code – [see finishes](#)

• Available as standard (included in basic price)

○ Available as an option (included in basic price)

| | | | | CREVA MEETING TABLE H LGM RCR |
|--------------------------------------|--|--|---------------------------|-------------------------------|
| | Width (mm) | | | 2000 |
| | Depth (mm) | | | 1100/800 |
| Cable management | No cable management | | | • |
| | Horizontal: | felt, grey colour | HC-KUFL1 | 199 |
| | Vertical: | upholstered, black colour | VC-U-STG60999 | 39 |
| | Horizontal: felt, grey colour | Vertical: upholstered, black colour | HC-KUFL1 VC-U-STG60999 | 238 |
| Glides | Plastic | | | • |
| | Plastic with felt | | | ○ |
| Wood and wood-based materials | Raw material - EU Timber regulation | | EUTR | • |
| Assembly | Partially Assembled | | ASM-P | • |
| Sample order | CREVA MEETING TABLE H LGM RCR (W2000 D1100/800 FSP KNB BC-BK GDF EUTR ASM-P) | | | |

- Available as standard (included in basic price)
- Available as an option (included in basic price)

Price list

Creva meeting table LGM RCG

Rectangular table top with gap.
25 mm table top thickness for Melamine (MFC) finish.
27 mm table top thickness for Laminate, Veneer and Fenix finish.
Base – metal legs.

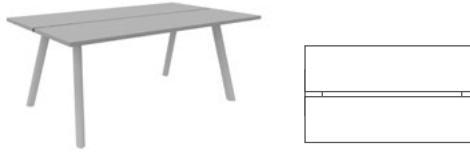

CREVA MEETING TABLE LGM RCG

| | | | | | | | | | | |
|----------------------|----------------|--|----------------|-----------------|----------------|-----------------|-----------------|-----------------|-----------------|-----------------|
| Number of table tops | Melamine (MFC) | 2 | 2 | 4 | 2 | 4 | 4 | 4 | 4 | 4 |
| | Laminate | 2 | 2 | — | 2 | — | 4 | — | 4 | 4 |
| | Fenix NTM® | 2 | 2 | 2 | 2 | 2 | 4 | 2 | 4 | 4 |
| | Veneer | 2 | 2 | — | 2 | — | 4 | — | 4 | 4 |
| Number of legs | | 4 | 4 | 4 | 4 | 4 | 6 | 4 | 6 | 6 |
| Users | | up to 6 people | up to 8 people | up to 10 people | up to 8 people | up to 10 people | up to 12 people | up to 12 people | up to 14 people | up to 16 people |
| H (mm) | | 739/714* Melamine (MFC) 741/714* Fenix, Laminat, Fornir | | | | | | | | |
| WT (kg) | | 48,3 | 59,1 | 65,7 | 67,7 | 81,0 | 102,2 | 100,5 | 127,1 | 143,1 |

| | | | | | | | | | | |
|--|------|------|------|------|------|------|------|------|------|------|
| Width (mm) | W... | 1800 | 2400 | 3000 | 2400 | 3000 | 3600 | 3000 | 3600 | 4200 |
| Depth (mm) | D... | 1000 | | | 1200 | | | 1500 | | |
| Basic price (EUR) according to table top finishes | | | | | | | | | | |
| Melamine (MFC) | | 1153 | 1481 | 1596 | 1441 | 1547 | 1967 | 1813 | 2410 | 2940 |
| Laminate | | 1704 | 2129 | — | 2229 | — | 3068 | — | 3700 | 4457 |
| Fenix NTM® | | 2162 | 2702 | 2889 | 2638 | 2811 | 3631 | 3250 | 4363 | 5236 |
| Veneer | | 2200 | 2732 | — | 2857 | — | 3941 | — | 4724 | 5661 |

| | | | | | | | | | | | |
|---|--|---|-------------------------------------|-----|-----|-----|-----|----------------|-----|----------------|------|
| Table top core | Chipboard | FSP | • | | | | | | | | |
| | Medium density fibreboard (MDF) | MDF | 489 | 489 | 489 | 489 | 578 | 800 | 578 | 800 | 1066 |
| Table top finish for chipboard core | Melamine (MFC) | 2 mm glue technology ①② | • | | | | | | | | |
| | Laminate | Edge: 1 mm (matching table top colour) | • | • | — | • | — | • | — | • | • |
| | Fenix NTM® | Edge: 2 mm natural (matching table top colour) ① | • | | | | | | | | |
| | Veneer | 2 mm natural (matching table top colour) | • | • | — | • | — | • | — | • | • |
| Table top finish for medium density fibreboard (MDF) core | Laminate | Chamfered edge: 2 mm glue technology ①②-CE | • | • | — | • | — | • | — | • | • |
| | Fenix NTM® | 1 mm (matching table top colour) | • | | | | | | | | |
| | Veneer | Chamfered edge: 2 mm natural (matching table top colour) ①-CE | • | • | — | • | — | • | — | • | • |
| No grommets / media ports | | | • | | | | | | | | |
| Media | 1 × Media port W-Box PIP adjustable position | YKUO... | See media port configuration matrix | | | | — | See media port | — | — | |
| | 2 × Media port W-Box PIP adjustable position | YKUO.../YKUO... | — | — | — | — | — | See media port | — | See media port | |
| Base finish | Metal legs: | powder coated | • | | | | | | | | |
| | | chromium plated BC-③ | 100 | | | 150 | | 100 | | 150 | |

* x/y mm – x: overall height/y: height under table top

① – Please specify table top colour code/solid wood colour code – see finishes

② – Please specify table top edge finish – see finishes

③ – Please specify metal colour code – see finishes

• Available as standard (included in basic price)

| | | | | CREVA MEETING TABLE LGM RCG | | | | | | | | | |
|---|---|-------------------------------------|----------------------------|-----------------------------|------|------|------|------|------|------|------|------|-----|
| Width (mm) | | | | 1800 | 2400 | 3000 | 2400 | 3000 | 3600 | 3000 | 3600 | 4200 | |
| Depth (mm) | | | | 1000 | | | 1200 | | | 1500 | | | |
| Cable management | No cable management | | | ● | | | | | | | | | |
| | Horizontal: | felt, grey colour | HC-KUFL1 | 189 | 199 | 216 | 199 | 216 | 260 | 216 | 260 | 349 | |
| | Vertical: | upholstered, black colour | VC-U-STG60999 | 34 | | | | | | | | | |
| | Horizontal: felt, grey colour | Vertical: upholstered, black colour | VC-U-STG6 VC-U-STG60999 | 223 | 233 | 250 | 233 | 250 | 294 | 250 | 294 | 383 | |
| Glides | Plastic | | | ● | | | | | | | | | |
| | Plastic with felt | | | ○ | | | | | | | | | |
| Upper panel | No upper panel | | | ● | | | | | | | | | |
| | 1 × panel, upholstered, adjustable position Width: 910 mm, Height: 390 mm | Price group: | 2 | U-KUU1-⑤ | 345 | 345 | 345 | 345 | 345 | — | 345 | — | — |
| | | | 3 | | 367 | 367 | 367 | 367 | 367 | — | 367 | — | — |
| | | | 4 | | 398 | 398 | 398 | 398 | 398 | — | 398 | — | — |
| | | | 5 | | 420 | 420 | 420 | 420 | 420 | — | 420 | — | — |
| | 2 × panel, upholstered, adjustable position Width: 910 mm, Height: 390 mm | Price group: | 2 | 2XU-KUU1-⑤ | — | — | — | — | — | 689 | — | 689 | 689 |
| | | | 3 | | — | — | — | — | — | 734 | — | 734 | 734 |
| | | | 4 | | — | — | — | — | — | 796 | — | 796 | 796 |
| 5 | | | | — | — | — | — | — | 839 | — | 839 | 839 | |
| Wooden tray (matching base finish) | No wooden tray | | | ● | | | | | | | | | |
| | Wooden tray, adjustable position | natural | TR-KU1-① | 125 | | | | | | | | | |
| | | Solid wood: stained | | 134 | | | | | | | | | |
| Wood and wood-based materials | Raw material - EU Timber regulation | | | EUTR ● | | | | | | | | | |
| Assembly | Partially Assembled | | | ASM-P ● | | | | | | | | | |
| Sample order | CREVA MEETING TABLE LGM RCG (W1800 D1000 FSP KNB BC-BK GDF EUTR ASM-P) | | | | | | | | | | | | |

① – Please specify table top colour code/solid wood colour code – [see finishes](#)

⑤ – Please specify upholstery colour code from selected price group – [see finishes](#)

- Available as standard (included in basic price)
- Available as an option (included in basic price)

Price list

Creva meeting table LGM RCRG

Soft rectangular table top with rounded edges and gap.
25 mm table top thickness for Melamine (MFC) finish.
27 mm table top thickness for Laminate, Veneer and Fenix finish.
Base – metal legs.



CREVA MEETING TABLE LGM RCRG

| | | | | | | |
|----------------------|----------------|--|-----------------|-----------------|-----------------|-----------------|
| Number of table tops | Melamine (MFC) | 2 | 4 | 4 | 4 | 4 |
| | Laminate | 2 | — | — | 4 | 4 |
| | Fenix NTM* | 2 | 2 | 2 | 4 | 4 |
| | Veneer | 2 | — | — | 4 | 4 |
| Number of legs | | 4 | 4 | 4 | 6 | 6 |
| Users | | up to 8 people | up to 10 people | up to 10 people | up to 12 people | up to 14 people |
| H (mm) | | 739/714* Melamine (MFC) 741/714* Fenix, Laminat, Fornir | | | | |
| WT (kg) | | 61,8 | 73,2 | 89,5 | 113,3 | 127,3 |

| | | | | | | |
|----------------|------|--|--------------|--------------|--------------|--------------|
| Width (mm) | W... | 2400 | 3000 | 3000 | 3600 | 4200 |
| Depth (mm) | D... | 1200/ 780 | 1200/ 700 | 1500/ 980 | 1500/ 950 | 1500/ 800 |
| | | Basic price (EUR) according to table top finishes | | | | |
| Melamine (MFC) | | 1897 | 2025 | 2356 | 3147 | 3811 |
| Laminate | | 2881 | — | — | 4754 | 5703 |
| Fenix NTM® | | 3382 | 3605 | 4147 | 5580 | 6666 |
| Veneer | | 3660 | — | — | 6033 | 7202 |

| | | | | | | | |
|--|---------------------------------|--|---|-----|-----|--------------------------------|------|
| Table top core | Chipboard | FSP | • | | | | |
| | Medium density fibreboard (MDF) | MDF | 622 | 622 | 755 | 1021 | 1199 |
| Table top finish for chipboard core | Melamine (MFC) | 2 mm glue technology | • | | | | |
| | Laminate | Edge: 1 mm (matching table top colour) | • | — | — | • | • |
| | Fenix NTM® | | • | | | | |
| | Veneer | 2 mm natural (matching table top colour) | • | — | — | • | • |
| Table top finish for medium density fibreboard (MDF) core | Laminate | Chamfered edge: 2 mm glue technology | • | — | — | • | • |
| | Fenix NTM® | Chamfered edge: 1 mm (matching table top colour) | • | | | | |
| | Veneer | 2 mm natural (matching table top colour) | • | — | — | • | • |
| Media | No grommets / media ports | | • | | | | |
| | 1 × Media port W-Box PIP | adjustable position | YKUO... See media port configuration matrix | | | | |
| | 2 × Media port W-Box PIP | adjustable position | — | — | — | See media port | |
| Base finish | Metal legs: | powder coated | • | | | | |
| | | chromium plated | BC-③ | | 100 | 150 | |

* x/y mm – x: overall height/y: height under table top

① – Please specify table top colour code/solid wood colour code – [see finishes](#)

② – Please specify table top edge finish – [see finishes](#)

③ – Please specify metal colour code – [see finishes](#)

• Available as standard (included in basic price)

| | | | | CREVA MEETING TABLE LGM RCRG | | | | | |
|--------------------------------------|---|---------------------------|---------------------------|------------------------------|--------------|--------------|--------------|--------------|-----|
| | Width (mm) | | | 2400 | 3000 | 3000 | 3600 | 4200 | |
| | Depth (mm) | | | 1200/ 780 | 1200/ 700 | 1500/ 980 | 1500/ 950 | 1500/ 800 | |
| Cable management | No cable management | | | | | • | | | |
| | Horizontal: | felt, grey colour | HC-KUFL1 | 199 | 304 | 304 | 260 | 349 | |
| | Vertical: | upholstered, black colour | VC-U-STG60999 | 34 | | | | | |
| | Horizontal: | Vertical: | HC-KUFL1 VC-U-STG60999 | 233 | 338 | 338 | 294 | 383 | |
| Glides | Plastic | | GD | | | • | | | |
| | Plastic with felt | | GDF | | | o | | | |
| Upper panel | No upper panel | | | | | • | | | |
| | 1 × panel, upholstered, adjustable position Width: 910 mm, Height: 390 mm | Price group: | | 2 | 345 | 345 | 345 | — | — |
| | | | | 3 | 367 | 367 | 367 | — | — |
| | | | | 4 | 398 | 398 | 398 | — | — |
| | | | | 5 | 420 | 420 | 420 | — | — |
| | 2 × panel, upholstered, adjustable position Width: 910 mm, Height: 390 mm | Price group: | | 2 | — | — | — | 689 | 689 |
| | | | | 3 | — | — | — | 734 | 734 |
| | | | | 4 | — | — | — | 796 | 796 |
| | | | | 5 | — | — | — | 839 | 839 |
| | Wooden tray (matching base finish) | No wooden tray | | | | | • | | |
| Wooden tray, adjustable position | | Solid wood: | natural | TR-KU1-① | | | 125 | | |
| | stained | | | | | 134 | | | |
| Wood and wood-based materials | Raw material - EU Timber regulation | | | EUTR | | • | | | |
| Assembly | Partially Assembled | | | ASM-P | | • | | | |
| Sample order | CREVA MEETING TABLE LGM RCRG (W2400 D1200/780 FSP KNB BC-BK GDF EUTR ASM-P) | | | | | | | | |

① - Please specify table top colour code/solid wood ccolour code – [see finishes](#)

⑤ - Please specify upholstery colour code from selected price group – [see finishes](#)

• Available as standard (included in basic price)

o Available as an option (included in basic price)

Price list

Creva meeting table H LGM RCG

Rectangular table top with gap.
25 mm table top thickness for Melamine (MFC) finish.
27 mm table top thickness for Laminate, Veneer and Fenix finish.
Base – metal legs.



CREVA MEETING TABLE H LGM RCG

| | |
|----------------|--|
| Table top | 2-piece |
| Number of legs | 4 |
| Users | up to 6 people |
| H (mm) | 1098/1073* Melamine (MFC) 1100/1073* Fenix, Laminat, Fornir |
| WT (kg) | 54,7 |

| | | |
|--|------|------|
| Width (mm) | W... | 2000 |
| Depth (mm) | D... | 1000 |
| Basic price (EUR) according to table top finishes | | |
| Melamine (MFC) | | 1291 |
| Laminate | | 2014 |
| Fenix NTM® | | 2382 |
| Veneer | | 2586 |

| | | | | | |
|--|---------------------------------|--|----------------------------------|---|---|
| Table top core | Chipboard | | FSP | • | |
| | Medium density fibreboard (MDF) | | MDF | 489 | |
| Table top finish for chipboard core | Melamine (MFC) | 2 mm glue technology | ①/② | • | |
| | Laminate | Edge: | | • | |
| | Fenix NTM® | 1 mm (matching table top colour) | ① | • | |
| | Veneer | 2 mm natural (matching table top colour) | ① | • | |
| Table top finish for medium density fibreboard (MDF) core | Laminate | Chamfered edge: | 2 mm glue technology | ①/②-CE | • |
| | Fenix NTM® | Chamfered edge: | 1 mm (matching table top colour) | ①-CE | • |
| | Veneer | 2 mm natural (matching table top colour) | | | • |
| Media (wooden box matching base finish) | No grommets / media ports | | | • | |
| | 1 × Media port W-Box PIP | adjustable position | YKUO... | See media port configuration matrix | |
| Base finish | Metal legs: | powder coated | | • | |
| | | chromium plated | BC-③ | 100 | |

* x/y mm – x: overall height/y: height under table top

① – Please specify table top colour code/solid wood colour code – [see finishes](#)

② – Please specify table top edge finish – [see finishes](#)

③ – Please specify metal colour code – [see finishes](#)

• Available as standard (included in basic price)

| | | | | CREVA MEETING TABLE LGM RCRG |
|---|---|--|---------------------------|------------------------------|
| | Width (mm) | | | 2000 |
| | Depth (mm) | | | 1000 |
| Cable management | No cable management | | | • |
| | Horizontal: | felt, grey colour | HC-KUFL1 | 199 |
| | Vertical: | upholstered, black colour | VC-U-STG60999 | 39 |
| | Horizontal: felt, grey colour | Vertical: upholstered, black colour | HC-KUFL1 VC-U-STG60999 | 238 |
| Glides | Plastic | | | • |
| | Plastic with felt | | | ○ |
| Upper panel | No upper panel | | | • |
| | Panel, upholstered, adjustable position Width: 910 mm, Height: 390 mm | Price group: | 2 | 345 |
| | | | 3 | 367 |
| | | | 4 | 398 |
| | | | 5 | 420 |
| | | U-KUU1-⑤ | | |
| Wooden tray (matching base finish) | No wooden tray | | | • |
| | Wooden tray, adjustable position | Solid wood: | natural stained | TR-KU1-① |
| Wood and wood-based materials | Raw material - EU Timber regulation | | | EUTR |
| Assembly | Partially Assembled | | | ASM-P |
| Sample order | CREVA MEETING TABLE H LGM RCG (W2000 D1000 FSP KNB BC-BK GDF EUTR ASM-P) | | | |

① – Please specify table top colour code/solid wood colour code – [see finishes](#)

⑤ – Please specify upholstery colour code from selected price group – [see finishes](#)

- Available as standard (included in basic price)
- Available as an option (included in basic price)

Price list

Creva meeting table H LGM RCRG

Soft rectangular table top with rounded edges and gap.
25 mm table top thickness for Melamine (MFC) finish.
27 mm table top thickness for Laminate, Veneer and Fenix finish.
Base – metal legs.



CREVA MEETING TABLE H LGM RCRG

| | |
|----------------|---|
| Table top | 2-piece |
| Number of legs | 4 |
| Users | up to 6 people |
| H (mm) | 1098/1073* Melamine (MFC) 1100/1073* Fenix, Laminate, Fornir |
| WT (kg) | 53,8 |

| | | |
|--|------|----------|
| Width (mm) | W... | 2000 |
| Depth (mm) | D... | 1100/800 |
| Basic price (EUR) according to table top finishes | | |
| Melamine (MFC) | | 1579 |
| Laminate | | 2427 |
| Fenix NTM® | | 2854 |
| Veneer | | 3098 |

| | | | | | |
|--|---------------------------------|--|----------------------------------|---|---|
| Table top core | Chipboard | | FSP | • | |
| | Medium density fibreboard (MDF) | | MDF | 622 | |
| Table top finish for chipboard core | Melamine (MFC) | 2 mm glue technology | ①/② | • | |
| | Laminate | Edge: | | • | |
| | Fenix NTM® | 1 mm (matching table top colour) | ① | • | |
| | Veneer | 2 mm natural (matching table top colour) | | • | |
| Table top finish for medium density fibreboard (MDF) core | Laminate | Chamfered edge: | 2 mm glue technology | ①/②-CE | • |
| | Fenix NTM® | Chamfered edge: | 1 mm (matching table top colour) | ①-CE | • |
| | Veneer | 2 mm natural (matching table top colour) | | | • |
| Media (wooden box matching base finish) | No grommets / media ports | | | • | |
| | 1 × Media port W-Box PIP | adjustable position | YKUO... | See media port configuration matrix | |
| Base finish | Metal legs: | powder coated | | • | |
| | | chromium plated | BC-③ | 100 | |

* x/y mm – x: overall height/y: height under table top

① – Please specify table top colour code/solid wood colour code – [see finishes](#)

② – Please specify table top edge finish – [see finishes](#)

③ – Please specify metal colour code – [see finishes](#)

• Available as standard (included in basic price)

| | | | | CREVA MEETING TABLE H LGM RCRG |
|---|---|--|---------------------------|--------------------------------|
| | Width (mm) | | | 2000 |
| | Depth (mm) | | | 1100/800 |
| Cable management | No cable management | | | • |
| | Horizontal: | felt, grey colour | HC-KUFL1 | 199 |
| | Vertical: | upholstered, black colour | VC-U-STG60999 | 39 |
| | Horizontal: felt, grey colour | Vertical: upholstered, black colour | HC-KUFL1 VC-U-STG60999 | 238 |
| Glides | Plastic | | | • |
| | Plastic with felt | | | ◦ |
| Upper panel | No upper panel | | | • |
| | Panel, upholstered, adjustable position Width: 910 mm, Height: 390 mm | Price group: | 2 | 345 |
| | | | 3 | 367 |
| | | | 4 | 398 |
| | | | 5 | 420 |
| | | U-KUU1-⑤ | | |
| Wooden tray (matching base finish) | No wooden tray | | | • |
| | Wooden tray, adjustable position | Solid wood: | natural stained | TR-KU1-① |
| | | | | 125 |
| | | | | 134 |
| Wood and wood-based materials | Raw material - EU Timber regulation | | | EUTR |
| | | | | • |
| Assembly | Partially Assembled | | | ASM-P |
| | | | | • |
| Sample order | CREVA MEETING TABLE H LGM RCRG (W2000 D1100/800 FSP KNB BC-BK GDF EUTR ASM-P) | | | |

① – Please specify table top colour code/solid wood colour code – [see finishes](#)

⑤ – Please specify upholstery colour code from selected price group – [see finishes](#)

• Available as standard (included in basic price)

◦ Available as an option (included in basic price)

Price list

Creva table panel KU UP UPH 1, upholstered

Dedicated for Creva meeting tables with gap between table tops.
Adjustable and lockable position, adapter included.



DESK PANEL KU UP UPH 1

| | |
|--------|-----|
| W (mm) | 910 |
| H (mm) | 390 |

Basic price (EUR)
according to upholstery price group

| | |
|---------------|-----|
| Price group 2 | 345 |
| Price group 3 | 367 |
| Price group 4 | 398 |
| Price group 5 | 420 |

| | | | |
|---------------|------------|---|---|
| Finish | Upholstery | ⑤ | • |
|---------------|------------|---|---|

Sample order DESK PANEL KU UP UPH 1 (VL9035)

Creva wooden tray

Dedicated for Creva meeting tables with gap between table tops.
Adjustable and lockable position, adapter included.

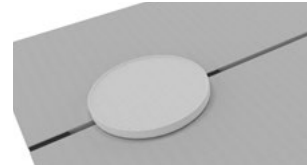

TABLE ACCESSORY KU TRAY W 1

Basic price (EUR)

125

| | | | | |
|---------------|-------------|---------|------|----|
| Finish | Solid wood: | natural | SKNB | • |
| | | stained | ① | 10 |

Sample order TABLE ACCESSORY KU TRAY W 1 (SKNB)

Price list

Media port

| | Media ports configuration for table tops without gap | | Standard | Finish | | Price (EUR) |
|--------------------------|--|---|----------------|--------------------|------------|-------------|
| Media port Netbox | 3 × power socket | 1 × USB charger (type C) | ⑧ – FR, GB, GE | SM Silver metallic | YG012-⑧-SM | 385 |
| Turn Comfort 4M | 3 × power socket | 1 × HDMI with connection cable 2900 mm length | | | YG010-⑧-SM | 860 |

⑧ – Please specify media port standard: FR, GB, GE

Media port

| Media ports configuration for 2-piece table tops with gap | | Standard | Finish | Price (EUR) | | | |
|---|-------------------------------------|----------------------|-----------|-------------------|-------------------------------------|-----------------------|-------------------|
| Media port W-Box PIP 1M | 1 × power socket 230V | ⑧ – CH13, FR, GB, GE | ① natural | YKU003-⑧-① | 203 | | |
| | 1 × double USB charger (type A + C) | | | YKU004-⑧-① | 365 | | |
| | | | stained | 9 | | | |
| Media port W-Box PIP 2M | 2 × power socket 230V | ⑧ – CH13, FR, GB, GE | ① natural | YKU005-⑧-① | 288 | | |
| | 2 × double USB charger (type A + C) | | | YKU006-⑧-① | 612 | | |
| | 1 × power socket 230V | | | YKU007-⑧-① | 449 | | |
| | 1 × double USB charger (type A + C) | | | | | | |
| | | | stained | 9 | | | |
| Media port W-Box PIP 3M | 3 × power socket 230V | ⑧ – CH13, FR, GB, GE | ① natural | YKU008-⑧-① | 379 | | |
| | 3 × double USB charger (type A + C) | | | YKU009-⑧-① | 865 | | |
| | 2 × power socket 230V | | | YKU010-⑧-① | 540 | | |
| | 1 × double USB charger (type A + C) | | | | | | |
| | 1 × power socket 230V | | | YKU011-⑧-① | 702 | | |
| | 2 × double USB charger (type A + C) | | | | | | |
| | | | stained | 9 | | | |
| Media ports configuration for 4-piece table tops with gap | | Standard | Finish | Price (EUR) | | | |
| Media port W-Box PIP 1M | Media port W-Box PIP 1M | ⑧ – CH13, FR, GB, GE | ① natural | YKU003/YKU004-⑧-① | 567 | | |
| | | | | | stained | 576 | |
| Media port W-Box PIP 2M | Media port W-Box PIP 1M | ⑧ – CH13, FR, GB, GE | ① natural | YKU007/YKU003-⑧-① | 654 | | |
| | | | | | 1 × power socket 230V | 1 × power socket 230V | YKU007/YKU004-⑧-① |
| | 1 × double USB charger (type A + C) | | | | 1 × double USB charger (type A + C) | stained | |
| | | | | | | | |
| Media port W-Box PIP 3M | Media port W-Box PIP 1M | ⑧ – CH13, FR, GB, GE | ① natural | YKU010/YKU003-⑧-① | 746 | | |
| | | | | | 2 × power socket 230V | 1 × power socket 230V | YKU010/YKU004-⑧-① |
| | 1 × double USB charger (type A + C) | | | | 1 × double USB charger (type A + C) | stained | |
| | | | | | | | |
| Media port W-Box PIP 2M | Media port W-Box PIP 3M | ⑧ – CH13, FR, GB, GE | ① natural | YKU003/YKU004-⑧-① | 990 | | |
| | | | | | 1 × power socket 230V | 2 × power socket 230V | stained |
| | | | | | | | |

① - Please specify wood colour code – see finishes

⑧ – Please specify media port standard: FR, GB, GE

Finishes

Wood

Natural



SKNB
Natural
Beech

Stained



2.07Y
Black



2.06S
Slate



S39
Light Grey

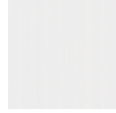

2.09S
White



2.0CB
Acacia



SK40
Oak



2.0CC
Walnut

Melamine (MFC)



CW
Black
Graphite



MG
Grey Vicenza
Oak



LW
Lincoln
Walnut

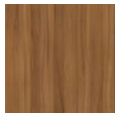

NW
Natural Dijon
Walnut



NZ
Natural
Hickory



HO
Hamilton Oak



ML
Kaisersberg
Oak



NJ
Acacia Light



NH
Maple



MM
Ellmau
Beech



CC
Black



MS
Slate



MP
Platinum

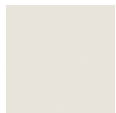

MB
White Grey



NK
Cashmere



BA
Truffle Grey



ST
Smoke Blue

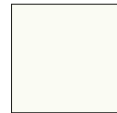

BI
White

Veneer

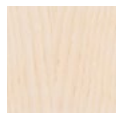

VN
White Ash



VT
Natural
Beech



DM
Natural Oak



VS
Natural
American
Walnut

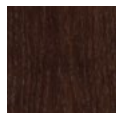

VM
Brown Oak

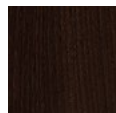

VP
Brown
American
Walnut

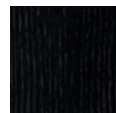

VO
Black Oak

Laminate

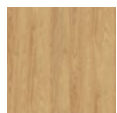

HZ
Natural
Hickory



KU
Hamilton Oak

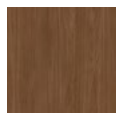

KT
Lincoln
Walnut



GN
Acacia Light



HE
Kaisersberg
Oak



FC
Grey Vicenza
Oak



HF
Ellmau
Beech



DD
Black



GW
Slate



BW
Platinum

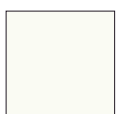

CA
White



FN
White Grey



HC
Cashmere



AA
Came Beige

Fenix NTM®



KJ
Nero Ingo



KN
Grigio Bromo



KM
Grigio Antrim



KP
Rosso Jaipur



KR
Verde Comodoro



KO
Blu Fes



KS
Bianco Kos

Edge

HPL Laminate



2 mm
plastic



2 mm
plastic with protective edge

Fenix NTM®



1 mm

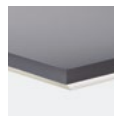

1 mm
50 mm chamfered lipping

Veneer



2 mm
natural wood



2 mm
natural wood on MDF, 50 mm chamfered lipping

Metal



Chrome
CR



RAL 9005
Jet Black
BK, BL



RAL 9006
White Aluminium
WK



RAL 9016
Traffic White
WT



RAL 9003
Signal White
WS



Silk
KSK



Silver 98
SV



DB 703
Iron Mica
IM



NCS S 2005-Y60R
Cashmere
NK



RAL 1024
Ochre Yellow
OY



RAL 030 50 40
Vermilion Red
VR



RAL 6003
Olive Green
OG



RAL 5000
Violet Blue
VB

General notes

All specified dimensions are approximate. Subject to minor modifications or differences for reasons of design improvements or for technical reasons.

- W = width
- D = depth
- H = height
- DI = diameter
- SH = seat height
- SH DIN = seat height measured acc. to DIN EN 1335-1
- WT = weight

In compliance with the highest quality standards "Quality is irreplaceable." Guided by this principle, each product line is subjected to stringent quality testing.

Warranty

Manufacturer declares that the products shall be free from defects in material or workmanship. The warranty is given to the original purchaser only, for normal commercial usage. Detailed terms of warranty and warranty periods are available at <https://www.kusch.com/en/warranty>

comta price list 2026

Comta

Design by Kusch + Co Designteam

Meeting table



COMTA MEETING TABLE LGW RC



COMTA MEETING TABLE LGW STS



COMTA MEETING TABLE LGM RC



COMTA MEETING TABLE LGM STS



COMTA MEETING TABLE H LGW RC



COMTA MEETING TABLE H LGW STS



COMTA MEETING TABLE H LGM RC



COMTA MEETING TABLE H LGM STS

Price list

Comta meeting table LGW RC

Rectangular table top.
19 mm table top thickness for Melamine (MFC) finish.
21 mm table top thickness for Laminate and Fenix finish.
Base – wooden legs.



COMTA MEETING TABLE LGW RC

| H (mm) | | 738/719* Melamine (MFC) 740/719* Laminate, Fenix | | | | | | | | | |
|---|--|---|-------------|---|------|--------|--------|--------|---|------|----|
| WT (kg) | | 44,5 | 54,9 | 65,8 | 61,6 | 73,6 | 87,9 | 103,7 | | | |
| Width (mm) | W... | 2000 | 2400 | 2800** | 2400 | 2800** | 3200** | 4000** | | | |
| Depth (mm) | D... | 1000 | 1000 | 1000 | 1200 | 1200 | 1200 | 1200 | | | |
| | | Basic price (EUR) according to table top finishes | | | | | | | | | |
| Melamine (MFC) | | 1220 | 1357 | 1413 | 1472 | 1531 | 1727 | 1974 | | | |
| Laminate | | 1744 | 1938 | — | 2102 | — | 2467 | 2820 | | | |
| Fenix NTM® | | 2089 | 2322 | 2416 | 2521 | 2620 | 2952 | 3376 | | | |
| Table top board core | Chipboard | FSP | | | | | | | • | | |
| | Melamine (MFC) | 2 mm glue technology | ①/② | | | | | | | • | |
| Table top finish | Laminate | Edge: | | • | • | — | • | — | • | • | |
| | Fenix NTM® | 1 mm (matching table top colour) | ① | | | | | | | • | |
| Media | No grommets/media ports | | | | | | | | | • | |
| | 1 × Media port Netbox turn Comfort 4 M | Position: central | YGO... | See media port configuration matrix | | | | — | — | | |
| | 2 × Media port Netbox turn Comfort 4 M | Position: central left, central right | 2XYGO... | — | — | — | — | — | See media port configuration matrix | | |
| Base finish | Powder-coated metal frame | Solid wood legs: | natural | | | | | | | • | |
| | | | stained | BC-③/① | | | | | | | 12 |
| | | | Natural oak | | | | | | | 105 | |
| Cable management (matching metal frame colour) for table top media port equipped | Horizontal: | None | | | | | | | • | | |
| | | Metal | HC-KUM1 | 109 | 109 | 145 | 109 | 145 | 188 | 202 | |
| Wood and wood-based materials | Raw material - EU Timber regulation | | EUTR | | | | | | | • | |
| Wooden elements lacquering | Water lacquer UV | | UV | | | | | | | • | |
| | Water lacquer | | | | | | | | | - 20 | |
| Assembly | Partially Assembled | | ASM-P | | | | | | | • | |

Sample order COMTA MEETING TABLE LGW RC (W2000 D1000 FSP CA/BI BC-WS/SKNO EUTR UV ASM-P)

* x/y mm – x: overall height/y: height under table top

** Tables widths 2800, 3200 and 4000 mm consist of two-piece table tops

① – Please specify table top colour code/solid wood colour code – [see finishes](#)

② – Please specify table top edge finish – [see finishes](#)

③ – Please specify metal colour code – [see finishes](#)

• Available as standard (included in basic price)

Price list

Comta meeting table LGW STS

Stadium shaped table top.
19 mm table top thickness for Melamine (MFC) finish.
21 mm table top thickness for Laminate and Fenix finish.
Base – wooden legs.



COMTA MEETING TABLE LGW STS

| | | 738/719* Melamine (MFC) 740/719* Laminate, Fenix | | | | | | |
|---|--|---|-------------|---|--------|-----|-----|---|
| H (mm) | | | | | | | | |
| WT (kg) | | 42,6 | 52,8 | 59,0 | 70,6 | | | |
| Width (mm) | W*** | 2000 | 2400 | 2400 | 2800** | | | |
| Depth (mm) | D*** | 1000 | 1000 | 1200 | 1200 | | | |
| Basic price (EUR) according to table top finishes | | | | | | | | |
| Melamine (MFC) | | 1401 | 1560 | 1694 | 1760 | | | |
| Laminate | | 2001 | 2229 | 2419 | – | | | |
| Fenix NTM® | | 2401 | 2669 | 2898 | 3012 | | | |
| Table top board core | Chipboard | FSP | | | • | | | |
| Table top finish | Melamine (MFC) | 2 mm glue technology | ①/② | | • | | | |
| | Laminate | | | Edge: | • | • | • | – |
| | Fenix NTM® | | | 1 mm (matching table top colour) | ① | | • | |
| Media | No grommets/media ports | | | | • | | | |
| | 1 × Media port Netbox turn Comfort 4 M | Position: central | YG0*** | See media port configuration matrix | | | | |
| Base finish | Metal frame: powder-coated | Solid wood legs: | natural | | • | | | |
| | | | stained | BC-③/① | 12 | | | |
| | | | Natural oak | | 105 | | | |
| Cable management (matching metal frame colour) for table top media port equipped | Horizontal: | None | | | • | | | |
| | | Metal | HC-KUM1 | 109 | 109 | 109 | 145 | |
| Wood and wood-based materials | Raw material - EU Timber regulation | | EUTR | | • | | | |
| Wooden elements lacquering | Water lacquer UV | | UV | | • | | | |
| | Water lacquer | | | | – 20 | | | |
| Assembly | Partially Assembled | | ASM-P | | • | | | |
| Sample order | COMTA MEETING TABLE LGW STS (W2000 D1000 FSP CA/BI BC-WS/SKNO EUTR UV ASM-P) | | | | | | | |

* x/y mm – x: overall height/y: height under table top

** Tables widths 2800 mm consist of two-piece table tops

① – Please specify table top colour code/solid wood colour code – [see finishes](#)

② – Please specify table top edge finish – [see finishes](#)

③ – Please specify metal colour code – [see finishes](#)

• Available as standard (included in basic price)

Price list

Comta meeting table LGM STS

Stadium shaped table top.
19 mm table top thickness for Melamine (MFC) finish.
21 mm table top thickness for Laminate and Fenix finish.
Base – metal legs.



COMTA MEETING TABLE LGM STS

| | | 738/719* Melamine (MFC) 740/719* Laminate, Fenix | | | | |
|---|--|---|--------------------|---|--------|-----|
| H (mm) | | 53,6 | 63,8 | 70,0 | 81,6 | |
| WT (kg) | | 53,6 | 63,8 | 70,0 | 81,6 | |
| Width (mm) | W... | 2000 | 2400 | 2400 | 2800** | |
| Depth (mm) | D... | 1000 | 1000 | 1200 | 1200 | |
| Basic price (EUR) according to table top finishes | | | | | | |
| Melamine (MFC) | | 1313 | 1472 | 1605 | 1672 | |
| Laminate | | 1875 | 2102 | 2293 | — | |
| Fenix NTM® | | 2281 | 2550 | 2779 | 2893 | |
| Table top board core | Chipboard | FSP | | | • | |
| Table top finish | Melamine (MFC) | 2 mm glue technology | ①/② | | • | |
| | Laminate | | | Edge: | • | • |
| | Fenix NTM® | 1 mm (matching table top colour) | ① | | • | |
| Media | No grommets/media ports | | | | • | |
| | 1 × Media port Netbox turn Comfort 4 M | Position: central | YG0... | See media port configuration matrix | | |
| Base finish | Metal frame: powder-coated | | BC-③ | | • | |
| Cable management (matching metal frame colour) for table top media port equipped | None | | None | | • | |
| | Horizontal: | Vertical: | | | | |
| | Metal | Metal | HC-KUM1 VC-KUM1 | 138 | 138 | 138 |
| Wood and wood-based materials | Raw material - EU Timber regulation | | EUTR | | • | |
| Assembly | Partially Assembled | | ASM-P | | • | |
| Sample order | COMTA MEETING TABLE LGM STS (W2000 D1000 FSP NJ/NJ BC-WS EUTR ASM-P) | | | | | |

* x/y mm – x: overall height/y: height under table top

** Tables widths 2800 mm consist of two-piece table tops

① – Please specify table top colour code/solid wood colour code – [see finishes](#)

② – Please specify table top edge finish – [see finishes](#)

③ – Please specify metal colour code – [see finishes](#)

• Available as standard (included in basic price)

Comta high meeting table H LGW RC

Rectangular table top.
 19 mm table top thickness for Melamine (MFC) finish.
 21 mm table top thickness for Laminate and Fenix finish.
 Base – wooden legs.



COMTA MEETING TABLE H LGW RC

| | | 1098/1079* Melamine (MFC) 1100/1079* Laminate, Fenix | | | | |
|---|---|---|-------------|-------------------------------------|--------|-----|
| H (mm) | | 46,1 | 56,5 | 63,2 | 78,7 | |
| WT (kg) | | 46,1 | 56,5 | 63,2 | 78,7 | |
| Width (mm) | W*** | 2000 | 2400 | 2400 | 3000** | |
| Depth (mm) | D*** | 1000 | 1000 | 1200 | 1200 | |
| | | Basic price (EUR) according to table top finishes | | | | |
| Melamine (MFC) | | 1324 | 1461 | 1575 | 1663 | |
| Laminate | | 1892 | 2087 | 2250 | – | |
| Fenix NTM® | | 2227 | 2461 | 2660 | 2808 | |
| Table top board core | Chipboard | FSP | | | • | |
| Table top finish | Melamine (MFC) | 2 mm glue technology ①/② | | | • | |
| | Laminate | | Edge: | • | • | • |
| | Fenix NTM® | 1 mm (matching table top colour) ① | | | • | |
| Media | No grommets/media ports | | | | • | |
| | 1 × Media port Netbox turn Comfort 4 M | Position: central | YGO*** | See media port configuration matrix | | |
| Base finish | Metal frame: powder-coated | Solid wood legs: | natural | | • | |
| | | | stained | BC-③/① | 35 | |
| | | | Natural oak | | 220 | |
| Cable management (matching metal frame colour) for table top media port equipped | Horizontal: | None | | | • | |
| | | Metal | HC-KUM1 | 109 | 109 | 109 |
| Wood and wood-based materials | Raw material - EU Timber regulation | | EUTR | | • | |
| Wooden elements lacquering | Water lacquer UV | | UV | | • | |
| | Water lacquer | | | | – 20 | |
| Assembly | Partially Assembled | | ASM-P | | • | |
| Sample order | COMTA MEETING TABLE H LGW RC (W2000 D1000 FSP CA/BI BC-WS/SKNO EUTR UV ASM-P) | | | | | |

* x/y mm – x: overall height/y: height under table top

** Tables widths 3000mm consist of two-piece table tops

① – Please specify table top colour code/solid wood colour code – see finishes

② – Please specify table top edge finish – see finishes

③ – Please specify metal colour code – see finishes

• Available as standard (included in basic price)

Price list

Comta high meeting table H LGW STS

Stadium shaped table top.
19 mm table top thickness for Melamine (MFC) finish.
21 mm table top thickness for Laminate and Fenix finish.
Base – wooden legs.



COMTA MEETING TABLE H LGW STS

| | | 1098/1079* Melamine (MFC) 1100/1079* Laminate, Fenix | | | |
|---|--|---|-------------|-------------------------------------|--------|
| | | 44,2 | 54,4 | 60,6 | 75,4 |
| Width (mm) | W*** | 2000 | 2400 | 2400 | 3000** |
| Depth (mm) | D*** | 1000 | 1000 | 1200 | 1200 |
| | | Basic price (EUR) according to table top finishes | | | |
| Melamine (MFC) | | 1523 | 1678 | 1812 | 1915 |
| Laminate | | 2176 | 2398 | 2588 | – |
| Fenix NTM® | | 2560 | 2829 | 3057 | 3231 |
| Table top board core | Chipboard | FSP | | • | |
| Table top finish | Melamine (MFC) | 2 mm glue technology ①/② | | • | |
| | Laminate | | Edge: | • | • |
| | Fenix NTM® | 1 mm (matching table top colour) ① | | • | |
| Media | No grommets/media ports | | | • | |
| | 1 × Media port Netbox turn Comfort 4 M | Position: central | YGO*** | See media port configuration matrix | |
| Base finish | Metal frame: powder-coated | Solid wood legs: | natural | | • |
| | | | stained | BC-③/① | 35 |
| | | | Natural oak | | 220 |
| Cable management (matching metal frame colour) for table top media port equipped | Horizontal: | None | | • | |
| | | Metal | HC-KUM1 | 109 | 109 |
| Wood and wood-based materials | Raw material - EU Timber regulation | | EUTR | | • |
| Wooden elements lacquering | Water lacquer UV | | UV | | • |
| | Water lacquer | | | | - 20 |
| Assembly | Partially Assembled | | ASM-P | | • |
| Sample order | COMTA MEETING TABLE H LGW STS (W2000 D1000 FSP CA/BI BC-WS/SKNO EUTR UV ASM-P) | | | | |

* x/y mm – x: overall height/y: height under table top

** Tables widths 3000 mm consist of two-piece table tops

① – Please specify table top colour code/solid wood colour code – see finishes

② – Please specify table top edge finish – see finishes

③ – Please specify metal colour code – see finishes

• Available as standard (included in basic price)

Comta high meeting table H LGM RC

Rectangular table top.
 19 mm table top thickness for Melamine (MFC) finish.
 21 mm table top thickness for Laminate and Fenix finish.
 Base – metal legs.



COMTA MEETING TABLE H LGM RC

| | | 1098/1079* Melamine (MFC) 1100/1079* Laminate, Fenix | | | | |
|---|---|---|--------|--------------------|---|---|
| H (mm) | | 61,7 | 72,1 | 78,8 | 94,3 | |
| WT (kg) | | 61,7 | 72,1 | 78,8 | 94,3 | |
| Width (mm) | W... | 2000 | 2400 | 2400 | 3000** | |
| Depth (mm) | D... | 1000 | 1000 | 1200 | 1200 | |
| Basic price (EUR) according to table top finishes | | | | | | |
| Melamine (MFC) | | 1235 | 1372 | 1487 | 1575 | |
| Laminate | | 1764 | 1960 | 2123 | – | |
| Fenix NTM® | | 2108 | 2341 | 2540 | 2689 | |
| Table top board core | Chipboard | FSP | | | • | |
| Table top finish | Melamine (MFC) | 2 mm glue technology | ①/② | | • | |
| | Laminate | | | Edge: | • | • |
| | Fenix NTM® | 1 mm (matching table top colour) | ① | | • | |
| Media | No grommets/media ports | | | | • | |
| | 1 × Media port Netbox turn Comfort 4 M | Position: central | YGO... | | See media port configuration matrix | |
| Base finish | Metal frame: powder-coated | | BC-③ | | • | |
| Cable management (matching metal frame colour) for table top media port equipped | None | None | | | • | |
| | Horizontal: _____ Vertical: _____ | Metal | Metal | HC-KUM1 VC-KUM1 | 142 142 142 176 | |
| Wood and wood-based materials | Raw material - EU Timber regulation | | EUTR | | • | |
| Assembly | Partially Assembled | | ASM-P | | • | |
| Sample order | COMTA MEETING TABLE H LGM RC (W2000 D1000 FSP CA/BI BC-WS EUTR ASM-P) | | | | | |

* x/y mm – x: overall height/y: height under table top

** Tables widths 3000 mm consist of two-piece table tops

① – Please specify table top colour code/solid wood colour code – [see finishes](#)

② – Please specify table top edge finish – [see finishes](#)

③ – Please specify metal colour code – [see finishes](#)

• Available as standard (included in basic price)

Price list

Comta high meeting table H LGM STS

Stadium shaped table top.
19 mm table top thickness for Melamine (MFC) finish.
21 mm table top thickness for Laminate and Fenix finish.
Base – metal legs.



COMTA MEETING TABLE H LGM STS

| | | 1098/1079* Melamine (MFC) 1100/1079* Laminate, Fenix | | | | |
|---|--|---|--------------------|--------|---|-----|
| H (mm) | | 59,8 | 69,9 | 76,2 | 91,0 | |
| Width (mm) | W... | 2000 | 2400 | 2400 | 3000** | |
| Depth (mm) | D... | 1000 | 1000 | 1200 | 1200 | |
| | | Basic price (EUR) according to table top finishes | | | | |
| Melamine (MFC) | | 1435 | 1590 | 1724 | 1827 | |
| Laminate | | 2050 | 2271 | 2462 | — | |
| Fenix NTM® | | 2441 | 2709 | 2937 | 3112 | |
| Table top board core | Chipboard | FSP | | | • | |
| Table top finish | Melamine (MFC) | 2 mm glue technology | ①/② | | • | |
| | Laminate | | | Edge: | • | • |
| | Fenix NTM® | 1 mm (matching table top colour) | ① | | • | |
| Media | No grommets/media ports | | | | • | |
| | 1 × Media port Netbox turn Comfort 4 M | Position: | central | YGO... | See media port configuration matrix | |
| Base finish | Metal frame: powder-coated | | BC-③ | | • | |
| Cable management (matching metal frame colour) for table top media port equipped | None | | None | | • | |
| | Horizontal: | Vertical: | | | | |
| | Metal | Metal | HC-KUM1 VC-KUM1 | 142 | 142 | 142 |
| Wood and wood-based materials | Raw material - EU Timber regulation | | EUTR | | • | |
| Assembly | Partially Assembled | | ASM-P | | • | |

Sample order COMTA MEETING TABLE H LGM STS (W2000 D1000 FSP NJ/NJ BC-WS EUTR ASM-P)

* x/y mm – x: overall height/y: height under table top

** Tables widths 3000 mm consist of two-piece table tops

① – Please specify table top colour code/solid wood colour code – [see finishes](#)

② – Please specify table top edge finish – [see finishes](#)

③ – Please specify metal colour code – [see finishes](#)

• Available as standard (included in basic price)

Comta horizontal wire trunking KU HC M 1

Dedicated for Comta meeting table, metal powder-coated.



CABLE MANAGEMENT KU HC M 1

| For integration with table top width (mm) | W... | 2000 | 2400 | 2800 | 3200 | 4000 |
|---|------|-------------------|------|------|------|------|
| | | Basic price (EUR) | | | | |
| | | 109 | 109 | 145 | 188 | 202 |

| | | | |
|---------------|---------------------|---|---|
| Finish | Powder-coated steel | ① | • |
|---------------|---------------------|---|---|

| | |
|---------------------|--------------------------------------|
| Sample order | CABLE MANAGEMENT KU HC M 1(W2000 WS) |
|---------------------|--------------------------------------|

① – Please specify table top colour code/solid wood colour code – see finishes

- Available as standard (included in basic price)

Comta vertical wire trunking KU VC M 1

Dedicated for Comta meeting tables LGM metal legs.



CABLE MANAGEMENT KU VC M 1

| Basic price (EUR) | |
|-------------------|----|
| | 38 |

| | | | |
|--------------------|---------------------------|---------|---|
| Finish | Powder-coated steel | ① | • |
| Integration | with 740 mm table height | IN-740 | • |
| | with 1100 mm table height | IN-1100 | 4 |

| | |
|---------------------|-------------------------------------|
| Sample order | CABLE MANAGEMENT KU VC M(WS IN-740) |
|---------------------|-------------------------------------|

① – Please specify table top colour code/solid wood colour code – see finishes

- Available as standard (included in basic price)

Media port

| | Media ports configuration | Standard | Finish | Price (EUR) | |
|--|--|----------------|--------------------|-------------|-----|
| | | | | | |
| Media port Netbox Turn Comfort 4M | 3 × power socket 1 × USB charger (type C) | ⑧ – FR, GB, GE | SM Silver metallic | YG012-⑧-SM | 385 |
| | 3 × power socket 1 × HDMI with connection cable, length 2900 mm | | | YG010-⑧-SM | 860 |
| | 1 × fuse 2 × power socket 1 × USB charger (type C) | CH | SM Silver metallic | YG018-⑧-SM | 385 |
| | 1 × fuse 2 × power socket 1 × HDMI with connection cable, length 2900 mm | | | YG016-⑧-SM | 860 |

⑧ – Please specify media port standard: FR, GB, GE

Finishes

Wood

Natural



SKNB

Natural
Beech

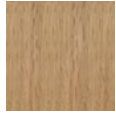

SKNO

Natural Oak

Stained



2.07Y

Black



2.06S

Slate



S39

Light Grey



2.09S

White



2.0CB

Acacia



SK40

Oak



2.0CC

Walnut

Melamine (MFC)



CW

Black
Graphite



MG

Grey Vicenza
Oak



LW

Lincoln
Walnut

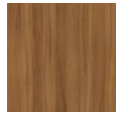

NW

Natural Dijon
Walnut

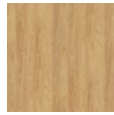

NZ

Natural
Hickory



HO

Hamilton Oak



ML

Kaisersberg
Oak



NJ

Acacia Light



NH

Maple



MM

Ellmau
Beech



CC

Black



MS

Slate



MP

Platinum



MB

White Grey



NK

Cashmere



BA

Truffle Grey



ST

Smoke Blue

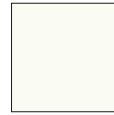

BI

White

Laminate

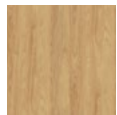

HZ

Natural
Hickory



KU

Hamilton Oak

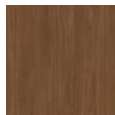

KT

Lincoln
Walnut



GN

Acacia Light



HE

Kaisersberg
Oak



FC

Grey Vicenza
Oak



HF

Ellmau
Beech



DD

Black



GW

Slate



BW

Platinum



CA

White

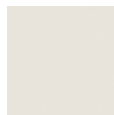

FN

White Grey



HC

Cashmere

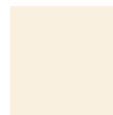

AA

Came Beige

Fenix NTM®



KJ
Nero Ingo



KN
Grigio Bromo



KM
Grigio Antrim



KP
Rosso Jaipur



KR
Verde Comodoro



KO
Blu Fes

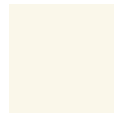

KS
Bianco Kos

Edge

HPL Laminate



2 mm
plastic

Fenix NTM®



1 mm

Metal



RAL 9011
Graphite Black
BLK



RAL 9003
Signal White
WS

General notes

All specified dimensions are approximate. Subject to minor modifications or differences for reasons of design improvements or for technical reasons.

- W = width
- D = depth
- H = height
- DI = diameter
- SH = seat height
- SH DIN = seat height measured acc. to DIN EN 1335-1
- WT = weight

In compliance with the highest quality standards "Quality is irreplaceable." Guided by this principle, each product line is subjected to stringent quality testing.

Warranty

Manufacturer declares that the products shall be free from defects in material or workmanship. The warranty is given to the original purchaser only, for normal commercial usage.

Detailed terms of warranty and warranty periods are available at

<https://www.kusch.com/en/warranty>

san_siro
meeting
tables
price list
2026

san_siro meeting table

Design by Norbert Geelen

Meeting table – metal base



SAN SIRO MEETING
TABLE 4A SQ



SAN SIRO MEETING
TABLE T-LEG RC 1



SAN SIRO MEETING
TABLE 4A RD 1

Folding table



SAN SIRO MEETING TABLE
T-LEG TF RC 1



SAN SIRO MEETING TABLE
T-LEG TF RC 2



SAN SIRO MEETING TABLE
T-LEG TF RC 3

Meeting table – wooden base



SAN SIRO MEETING TABLE
LWM SQ



SAN SIRO MEETING TABLE
LWM RC



SAN SIRO MEETING TABLE
LWM RD

Table – wooden base



SAN SIRO TABLE LWM SQ



SAN SIRO TABLE LWM RC



SAN SIRO TABLE LWM RD

Price list

san_siro meeting table 4A SQ

Square table top.
25 mm table top thickness for Melamine (MFC) and Melamine (MFC) – Organic finish.
27 mm table top thickness for Laminate and Fenix finish.
Base – four star.



SAN SIRO MEETING TABLE 4A SQ

| | | WT (kg) | 15,9 | 18,8 |
|---|---|---|------|------|
| Width (mm) | W... | 700 | 800 | |
| | Depth (mm) | D... | 700 | 800 |
| | | Basic price (EUR) according to table top finishes | | |
| Melamine (MFC) | | 268 | 307 | |
| Melamine (MFC) – Organic | | 309 | 354 | |
| Laminate | | 388 | 410 | |
| Fenix NTM® | | 500 | 559 | |
| Table top core | Chipboard | FSP | • | |
| | Medium density fibreboard (MDF) | MDF | 331 | |
| Table top finish for chipboard core | Melamine (MFC) | | • | |
| | Melamine (MFC) – Organic | Edge: 2 mm glue technology ①/② | • | |
| | Laminate | Protective edge: 2 mm glue technology ①/②-PE | • | |
| | Fenix NTM® | Edge: 1 mm (matching table top colour) ① | 85 | |
| Table top finish for medium density fibreboard (MDF) core | Laminate | Chamfered edge: 2 mm glue technology ①/②-CE | • | |
| | Fenix NTM® | Chamfered edge: 1 mm (matching table top colour) ①-CE | • | |
| Height | 735/710* Melamine (MFC) and Melamine (MFC) – Organic 737/710* Laminat i Fenix | (710 mm – under table top) H737 | • | • |
| | 1097/1072 mm* Melamina (MFC) i Melamina (MFC) – Organic 1099/1072 mm* Laminat i Fenix | (1072 mm – under table top) H1099 | 38 | – |
| Base finish | Powder-coated | Powder-coated BC-③ | • | |
| | Steel column: Chrome | Aluminium four star element: Polished BC-CR/POL | 49 | |
| | Satin chrome | Polished BC-SCR/POL | 57 | |
| Glides | Plastic glides | GD | • | |
| | Plastic glides, non-skid | GDN | 6 | |
| | Plastic glides with felt | GDF | 11 | |

① – Please specify table top colour code/solid wood colour code – [see finishes](#)

② – Please specify table top edge finish – [see finishes](#)

③ – Please specify metal colour code – [see finishes](#)

• Available as standard (included in basic price)

Price list

| SAN SIRO MEETING TABLE 4A SQ | | | | |
|---|---|-------|-----|-----|
| | Width (mm) | W... | 700 | 800 |
| | Depth (mm) | D... | 700 | 800 |
| Table top connectors (not applicable for table tops with chamfered edge) | No connector | | | • |
| | Plastic connector | TC | | 52 |
| Wood and wood-based materials | Raw material - EU Timber regulation | EUTR | | • |
| Assembly | Partially Assembled | ASM-P | | • |
| Sample order | SAN SIRO MEETING TABLE 4A SQ (W700 D700 FSP KN H737 BC-WS GDF EUTR ASM-P) | | | |

- Available as standard (included in basic price)

san_siro meeting table T-LEG RC 1

Rectangular table top.
25 mm table top thickness for Melamine (MFC) and Melamine (MFC) – Organic finish.
27 mm table top thickness for Laminate and Fenix finish.
Base – metal T-legs.



SAN SIRO MEETING TABLE T-LEG RC 1

| H (mm) | | 735/710* Melamine (MFC) i Melamine (MFC) – Organic 737/710* Laminate and Fenix | | | | | | | | | | | | | |
|--|---------------------------------|---|----------------------------------|---------------|------------|------|------|------|------|------|-----|-----|-----|--|--|
| WT (kg) | | 28,0 | 30,6 | 30,2 | 33,3 | 33,5 | 37,8 | 40,9 | 54,0 | 62,6 | | | | | |
| Width (mm) | W... | 1200 | 1400 | 1200 | 1400 | 1500 | 1600 | 1800 | 2000 | 2400 | | | | | |
| Depth (mm) | D... | 700 | 700 | 800 | 800 | 750 | 800 | 800 | 1000 | 1000 | | | | | |
| Melamine (MFC) | | Basic price (EUR) according to table top finishes | | | | | | | | | | | | | |
| Melamine (MFC) – Organic | | 427 | 446 | 429 | 456 | 461 | 531 | 536 | 668 | 960 | | | | | |
| | | 492 | 513 | 494 | 525 | 531 | 611 | 617 | 769 | 1104 | | | | | |
| Laminate | | 573 | 597 | 586 | 613 | 619 | 713 | 719 | 897 | 1290 | | | | | |
| Fenix NTM® | | 747 | 753 | 774 | 785 | 792 | 1026 | 1034 | 1352 | 1794 | | | | | |
| Table top core | Chipboard | FSP | • | | | | | | | | | | | | |
| | Medium density fibreboard (MDF) | MDF | 331 | 331 | 331 | 331 | 331 | 331 | 331 | 425 | 425 | | | | |
| Table top finish for chipboard core | Melamine (MFC) | | • | | | | | | | | | | | | |
| | Melamine (MFC) – Organic Edge: | 2 mm glue technology | ①/② | • | | | | | | | | | | | |
| | Laminate | Protective edge: | 2 mm glue technology | ①/②-PE | 85 | 85 | 85 | 85 | 85 | 85 | 85 | 170 | 170 | | |
| | Fenix NTM® | Edge: | 1 mm (matching table top colour) | ① | • | • | • | • | • | • | • | • | • | | |
| Table top finish for medium density fibreboard (MDF) core | Laminate | Chamfered edge: | 2 mm glue technology | ①/②-CE | • | | | | | | | | | | |
| | Fenix NTM® | Chamfered edge: | 1 mm (matching table top colour) | ①-CE | • | | | | | | | | | | |
| Base finish | Steel column: | Powder-coated | Aluminium foot: | Powder-coated | BC-③ | • | | | | | | | | | |
| | | Chrome | | Polished | BC-CR/POL | 60 | | | | | | | | | |
| | | Satin chrome | | Polished | BC-SCR/POL | 67 | | | | | | | | | |
| Glides / Castors | Plastic glides | | | GD | • | | | | | | | | | | |
| | Plastic glides, non-skid | | | GDN | 6 | | | | | | | | | | |
| | Plastic glides with felt | | | GDF | 11 | | | | | | | | | | |

* x/y mm – x: overall height/y: height under table top

① – Please specify table top colour code/solid wood colour code – [see finishes](#)

② – Please specify table top edge finish – [see finishes](#)

③ – Please specify metal colour code – [see finishes](#)

• Available as standard (included in basic price)

Price list

| | | SAN SIRO MEETING TABLE T-LEG RC 1 | | | | | | | | | |
|---|--|-----------------------------------|------|------|------|------|------|------|------|------|--|
| Width (mm) | | 1200 | 1400 | 1200 | 1400 | 1500 | 1600 | 1800 | 2000 | 2400 | |
| Depth (mm) | | 700 | 700 | 800 | 800 | 750 | 800 | 800 | 1000 | 1000 | |
| Table top connectors (not applicable for table tops with chamfered edge) | No connector | | | | | • | | | | | |
| | Plastic connector | | | | | 52 | | | | | |
| Wood and wood-based materials | Raw material - EU Timber regulation | | | | | • | | | | | |
| | Partially Assembled | | | | | • | | | | | |
| Assembly | Partially Assembled | | | | | • | | | | | |
| Sample order | SAN SIRO MEETING TABLE T-LEG RC 1 (W1200 D700 FSP KN BC-WS GDF EUTR ASM-P) | | | | | | | | | | |

- Available as standard (included in basic price)

san_siro meeting table 4A RD 1

Round table top.
 25 mm table top thickness for Melamine (MFC) and Melamine (MFC) – Organic finish.
 27 mm table top thickness for Laminate and Fenix finish.
 Base – metal four star.



SAN SIRO MEETING TABLE 4A RD 1

| H (mm) | | 735/710* Melamine (MFC) Melamine (MFC) – Organic 737/710* Laminate and Fenix | | | | | |
|--|---|---|------------------------------|---------------|------------|------|------|
| WT (kg) | | 16,2 | 19,6 | 22,4 | 35,6 | 39,0 | |
| Diameter (mm) | | DI... | 800 | 900 | 1000 | 1100 | 1200 |
| Basic price (EUR) according to table top finishes | | | | | | | |
| Melamine (MFC) | | 317 | 478 | 482 | 541 | 546 | |
| Melamine (MFC) – Organic | | 365 | 550 | 555 | 623 | 628 | |
| Laminate | | 425 | 606 | 645 | 724 | 731 | |
| Fenix NTM® | | 589 | 811 | 840 | 995 | 1009 | |
| Table top core | Chipboard | FSP | • | | | | |
| | Medium density fibreboard (MDF) | MDF | 331 | | | | |
| Table top finish for chipboard core | Melamine (MFC) | | • | | | | |
| | Melamine (MFC) – Organic | Edge: 2 mm glue technology | ①/② | • | | | |
| | Laminate | | | • | | | |
| | Laminate | Protective edge: 2 mm glue technology | ①/②-PE | 85 | | | |
| | Fenix NTM® | Edge: 1 mm (matching table top colour) | ① | • | | | |
| Table top finish for medium density fibreboard (MDF) core | Laminate | Chamfered edge: 2 mm glue technology | ①/②-CE | • | | | |
| | Fenix NTM® | Chamfered edge: 1 mm (matching table top colour) | ①-CE | • | | | |
| Height | 737 mm (710 mm – under table top) | H737 | • | | | | |
| Media | No grommets / media ports | | • | | | | |
| Base finish | Steel column: | Powder-coated | Aluminium four star element: | Powder-coated | BC-③ | • | |
| | | Chrome | | Polished | BC-CR/POL | 52 | |
| | | Satin chrome | | Polished | BC-SCR/POL | 57 | |
| Glides / Castors | Plastic glides | | GD | • | | | |
| | Plastic glides, non-skid | | GDN | 6 | | | |
| | Plastic glides with felt | | GDF | 11 | | | |
| Wood and wood-based materials | Raw material - EU Timber regulation | EUTR | • | | | | |
| Assembly | Partially Assembled | ASM-P | • | | | | |
| Sample order | SAN SIRO MEETING TABLE 4A RD 1 (DI800 FSP KN H737 BC-WS GDF EUTR ASM-P) | | | | | | |

* x/y mm – x: overall height/y: height under table top

① – Please specify table top colour code/solid wood colour code – [see finishes](#)

② – Please specify table top edge finish – [see finishes](#)

③ – Please specify metal colour code – [see finishes](#)

• Available as standard (included in basic price)

Price list

san_siro mobile meeting table T-LEG TF RC 1

Rectangular folding table top.
25 mm table top thickness for Melamine (MFC) and Melamine (MFC) – Organic finish.
27 mm table top thickness for Laminate and Fenix finish.
Base – T-legs with castors. Stackable.



SAN SIRO MEETING TABLE T-LEG TF RC 1

| H (mm) | | 735/710* Melamine (MFC) i Melamine (MFC) – Organic 737/710* Laminate and Fenix | | | |
|---|---|---|---------------|-----------|------|
| WT (kg) | | 28,6 | 31,2 | 34,3 | 37,3 |
| Width (mm) | W... | 1400 | 1500 | 1600 | 1800 |
| Depth (mm) | D... | 700 | 750 | 800 | 800 |
| Basic price (EUR) according to table top finishes | | | | | |
| Melamine (MFC) | | 658 | 667 | 699 | 704 |
| Melamine (MFC) – Organic | | 757 | 768 | 804 | 810 |
| Laminate | | 883 | 897 | 938 | 945 |
| Fenix NTM® | | 1035 | 1044 | 1250 | 1257 |
| Table top core | Chipboard | FSP | • | • | • |
| | Medium density fibreboard (MDF) | MDF | 331 | 331 | 331 |
| Table top finish for chipboard core | Melamine (MFC) | | | • | |
| | Melamine (MFC) – Organic | Edge: 2 mm glue technology | ①/② | • | |
| | Laminate | Protective edge: 2 mm glue technology | ①/②-PE | • | |
| | Fenix NTM® | Edge: 1 mm (matching table top colour) | ① | • | |
| Table top finish for medium density fibreboard (MDF) core | Laminate | Chamfered edge: 2 mm glue technology | ①/②-CE | – | • |
| | Fenix NTM® | Chamfered edge: 1 mm (matching table top colour) | ①-CE | – | • |
| Base finish | Steel column: Powder-coated Chrome | Aluminium foot: | Powder-coated | BC-③ | • |
| | | | Polished | BC-CR/POL | 60 |
| Castors | Black castors (two with brakes) | | CAE | • | |
| | Black castors with chrome-plated ring (two with brakes) | | CACR | 72 | |
| Table top connectors (not applicable for table tops with chamfered edge) | No connector | | | • | |
| | Plastic connector | | TC | 52 | |
| Wood and wood- based materials | Raw material - EU Timber regulation | | EUTR | • | |
| Assembly | Assembled | | ASM-F | • | |

Sample order SAN SIRO MEETING TABLE T-LEG TF RC 1 (W1400 D700 FSP KN BC-WS CAE EUTR ASM-F)

* x/y mm – x: overall height/y: height under table top

① – Please specify table top colour code/solid wood colour code – see finishes

② – Please specify table top edge finish – see finishes

③ – Please specify metal colour code – see finishes

• Available as standard (included in basic price)

san_siro mobile meeting table T-LEG TF RC 2

Rectangular folding.
25 mm table top thickness for Melamine (MFC) and Melamine (MFC) – Organic finish.
27 mm table top thickness for Laminate and Fenix finish.
Base – metal T-legs, with castors, with automatic rotation when folding the tabletop.
Stackable.



SAN SIRO MEETING TABLE T-LEG TF RC 2

| H (mm) | | 735/710* Melamine (MFC) i Melamine (MFC) – Organic 737/710* Laminate and Fenix | | | |
|---|---|---|-----------|------|------|
| WT (kg) | | 35,6 | 38,4 | 38,3 | 42,8 |
| Width (mm) | W... | 1400 | 1500 | 1400 | 1600 |
| Depth (mm) | D... | 700 | 750 | 800 | 800 |
| Basic price (EUR) according to table top finishes | | | | | |
| Melamine (MFC) | | 884 | 908 | 896 | 940 |
| Melamine (MFC) – Organic | | 1017 | 1045 | 1031 | 1081 |
| Laminate | | 1189 | 1221 | 1204 | 1262 |
| Fenix NTM® | | 1344 | 1368 | 1350 | 1573 |
| Table top core | Chipboard | FSP | • | • | • |
| | Medium density fibreboard (MDF) | MDF | – | 331 | 331 |
| Table top finish for chipboard core | Melamine (MFC) | | | • | |
| | Melamine (MFC) – Organic | Edge: 2 mm glue technology | ①/② | • | |
| | Laminate | Protective edge: 2 mm glue technology | ①/②-PE | x | |
| | Fenix NTM® | Edge: 1 mm (matching table top colour) | ① | • | |
| Table top finish for medium density fibreboard (MDF) core | Laminate | Chamfered edge: 2 mm glue technology | ①/②-CE | – | • |
| | Fenix NTM® | Chamfered edge: 1 mm (matching table top colour) | ①-CE | | • |
| Base finish | Steel column: Powder-coated Chrome | Aluminium foot: Powder-coated Polished | BC-③ | | • |
| | | | BC-CR/POL | | 60 |
| Castors | Black castors (two with brakes) | | CAE | | • |
| | Black castors with chrome-plated ring (two with brakes) | | CACR | | 72 |
| Table top connectors (not applicable for table tops with chamfered edge) | No connector | | | | • |
| | Plastic connector | | TC | | 52 |
| Wood and wood-based materials | Raw material - EU Timber regulation | | EUTR | | • |
| Assembly | Assembled | | ASM-F | | • |
| Sample order | SAN SIRO MEETING TABLE T-LEG TF RC 2 (W1400 D700 FSP KN BC-WS CAE EUTR ASM-F) | | | | |

* x/y mm – x: overall height/y: height under table top

① – Please specify table top colour code/solid wood colour code – [see finishes](#)

② – Please specify table top edge finish – [see finishes](#)

③ – Please specify metal colour code – [see finishes](#)

• Available as standard (included in basic price)

Price list

san_siro mobile meeting table T-LEG TF RC 3

Rectangular folding table top.
25 mm table top thickness for Melamine (MFC) and Melamine (MFC) – Organic finish.
27 mm table top thickness for Laminate and Fenix finish.
Base – metal T-legs, with castors, with automatic rotation when folding the tabletop, set back from the table top edge. Stackable.



SAN SIRO MEETING TABLE T-LEG TF RC 3

| H (mm) | | 735/710* Melamine (MFC) i Melamine (MFC) – Organic 737/710* Laminate and Fenix | | | | | | | |
|---|---|---|-----------------|---------------|-----------|------|------|-----|-----|
| WT (kg) | | 35,6 | 38,4 | 42,8 | 47,4 | 50,8 | 58,0 | | |
| Width (mm) | W... | 1400 | 1500 | 1600 | 1800 | 1800 | 2000 | | |
| Depth (mm) | D... | 700 | 750 | 800 | 800 | 900 | 1000 | | |
| | | Basic price (EUR) according to table top finishes | | | | | | | |
| Melamine (MFC) | | 967 | 978 | 1036 | 1052 | 1054 | 1142 | | |
| Melamine (MFC) – Organic | | 1113 | 1125 | 1192 | 1210 | 1213 | 1314 | | |
| Laminate | | 1299 | 1313 | 1392 | 1413 | 1417 | 1631 | | |
| Fenix NTM® | | 1454 | 1461 | 1702 | 1727 | 1735 | 2113 | | |
| Table top core | Chipboard | FSP | • | • | • | • | • | | |
| | Medium density fibreboard (MDF) | MDF | – | 331 | 331 | 331 | 331 | 425 | |
| Table top finish for chipboard core | Melamine (MFC) | | | | • | | | | |
| | Melamine (MFC) – Organic | Edge: 2 mm glue technology | ①/② | | | • | | | |
| | Laminate | Protective edge: 2 mm glue technology | ①/②-PE | 85 | 85 | 85 | 85 | 85 | 170 |
| | Fenix NTM® | Edge: 1 mm (matching table top colour) | ① | • | • | • | • | • | • |
| Table top finish for medium density fibreboard (MDF) core | Laminate | Chamfered edge: 2 mm glue technology | ①/②-CE | – | • | • | • | • | • |
| | Fenix NTM® | Chamfered edge: 1 mm (matching table top colour) | ①-CE | – | • | • | • | • | • |
| Base finish | Steel column: | Powder-coated | Aluminium foot: | Powder-coated | BC-③ | | • | | |
| | | Chrome | | Polished | BC-CR/POL | | 60 | | |
| Castors | Black castors (two with brakes) | | | | CAE | | • | | |
| | Black castors with chrome-plated ring (two with brakes) | | | | CACR | | 72 | | |
| Table top connectors (not applicable for table tops with chamfered edge) | No connector | | | | | | • | | |
| | Plastic connector | | | | TC | | 52 | | |
| Wood and wood-based materials | Raw material - EU Timber regulation | | | | EUTR | | • | | |
| Assembly | Assembled | | | | ASM-F | | • | | |

Sample order SAN SIRO MEETING TABLE T-LEG TF RC 3 (W1400 D700 FSP KN BC-WS CAE EUTR ASM-F)

* x/y mm – x: overall height/y: height under table top

① – Please specify table top colour code/solid wood colour code – [see finishes](#)

② – Please specify table top edge finish – [see finishes](#)

③ – Please specify metal colour code – [see finishes](#)

• Available as standard (included in basic price)

san_siro meeting table LWM SQ

Square table top.
25 mm table top thickness for Melamine (MFC) and Melamine (MFC) – Organic finish.
27 mm table top thickness for Laminate and Fenix finish.
Base – wooden legs.



SAN SIRO MEETING TABLE LWM SQ

| | | Basic price (EUR) according to table top finishes | | | | |
|--------------------------------------|---|---|--------|------|------|------|
| H (mm) | | 739/714* Melamine (MFC) Melamine (MFC) – Organic 741/714* Laminate and Fenix | | | | |
| WT (kg) | | 14,4 | 16,9 | 19,8 | 23,0 | 25,8 |
| Width (mm) | W... | 600 | 700 | 800 | 900 | 1000 |
| Depth (mm) | D... | 600 | 700 | 800 | 900 | 1000 |
| Melamine (MFC) | | 388 | 399 | 416 | 429 | 441 |
| Melamine (MFC) – Organic | | 447 | 459 | 479 | 494 | 508 |
| Laminate | | 522 | 535 | 559 | 575 | 590 |
| Fenix NTM® | | 596 | 617 | 705 | 781 | 856 |
| Table top core | Chipboard | FSP | | | | • |
| | Melamine (MFC) | | | | | • |
| | Melamine (MFC) – Organic | Edge: 2 mm glue technology | ①/② | | | • |
| Table top finish | Laminate | Protective edge: 2 mm glue technology | ①/②-PE | | 85 | • |
| | Fenix NTM® | Edge: 1 mm (matching table top colour) | ① | | | • |
| Base finish | Fixing part: powder-coated steel | Wooden legs: Natural beech | | | | • |
| | | Stained beech | BC-③/① | | 14 | • |
| | | Natural oak | | | 106 | • |
| Glides | Plastic glides | | GD | | | • |
| | Plastic glides with felt | | GDF | | | ○ |
| Table top connectors | No connector | | | | | • |
| | Plastic connector | | TC | | 52 | • |
| Wood and wood-based materials | Raw material - EU Timber regulation | | EUTR | | | • |
| Wooden elements lacquering | Water lacquer UV | | UV | | | • |
| | Water lacquer | | | | -20 | • |
| Assembly | Assembled | | ASM-F | | | • |
| Sample order | SAN SIRO MEETING TABLE LWM SQ (W600 D600 FSP KN BC-WS/SKNO GDF EUTR UV ASM-F) | | | | | |

* x/y mm – x: overall height/y: height under table top

① – Please specify table top colour code/solid wood colour code – [see finishes](#)

② – Please specify table top edge finish – [see finishes](#)

③ – Please specify metal colour code – [see finishes](#)

• Available as standard (included in basic price)

○ Available as an option (included in basic price)

Price list

san_siro meeting table LWM RC

Rectangular table top.
25 mm table top thickness for Melamine (MFC) and Melamine (MFC) – Organic finish.
27 mm table top thickness for Laminate and Fenix finish.
Base – wooden legs.



SAN SIRO MEETING TABLE LWM RC

| H (mm) | | 739/714* Melamine (MFC) i Melamine (MFC) – Organic 741/714* Laminate and Fenix | | | | | | | | | | | |
|--|-------------------------------------|---|---|----------------------|---------|--------|------|------|------|-----|---|----|----|
| WT (kg) | | 26,2 | 27,6 | 28,9 | 31,9 | 35,0 | 38,4 | 41,8 | 45,6 | | | | |
| Width (mm) | W... | 1400 | 1500 | 1600 | 1600 | 1800 | 1800 | 2000 | 2000 | | | | |
| Depth (mm) | D... | 700 | 700 | 700 | 800 | 800 | 900 | 900 | 1000 | | | | |
| Basic price (EUR) according to table top finishes | | | | | | | | | | | | | |
| Melamine (MFC) | | 450 | 484 | 502 | 524 | 529 | 532 | 537 | 589 | | | | |
| Melamine (MFC) – Organic | | 518 | 557 | 578 | 603 | 609 | 612 | 618 | 678 | | | | |
| Laminate | | 603 | 650 | 674 | 703 | 710 | 714 | 721 | 791 | | | | |
| Fenix NTM® | | 756 | 806 | 875 | 1016 | 1024 | 1031 | 1177 | 1244 | | | | |
| Table top core | Chipboard | FSP | | | | | | | | • | | | |
| | Melamine (MFC) | | | | | | | | | • | | | |
| | Melamine (MFC) – Organic | Edge: | 2 mm glue technology | | ①/② | | | | | • | | | |
| | Table top finish | Laminate | | | | | | | | | • | | |
| | | Laminate | Protective edge: | 2 mm glue technology | | ①/②-PE | | 85 | 85 | 85 | 85 | 85 | 85 |
| | Fenix NTM® | Edge: | 1 mm (matching table top colour) | | ① | | • | • | • | • | • | • | • |
| Media | No grommets / media ports | | | | | | | | | | • | | |
| | Media port Netbox turn Comfort 4 M | | Central position | YGO... | | | | | | | See media port configuration matrix | | |
| Base finish | Fixing part: powder-coated steel | Wooden legs: | Natural beech | | | | | | | • | | | |
| | | | Stained beech | | BC-③/① | | | | | 14 | | | |
| | | | Natural oak | | | | | | | 106 | | | |
| Cable management | Vertical: | None | For configuration without media port only | | | | | | | • | | | |
| | | Cable spine (grey plastic) | Required for configuration equipped with media port | | VC-KUM2 | | | | | 111 | | | |
| Glides | Plastic glides | | | | GD | | | | | • | | | |
| | Plastic glides with felt | | | | GDF | | | | | ○ | | | |

* x/y mm – x: overall height/y: height under table top

① – Please specify table top colour code/solid wood colour code – [see finishes](#)

② – Please specify table top edge finish – [see finishes](#)

③ – Please specify metal colour code – [see finishes](#)

• Available as standard (included in basic price)

○ Available as an option (included in basic price)

| | | | SAN SIRO MEETING TABLE LWM RC | | | | | | | |
|--------------------------------------|--|-------|-------------------------------|------|------|------|------|------|------|------|
| | Width (mm) | W... | 1400 | 1500 | 1600 | 1600 | 1800 | 1800 | 2000 | 2000 |
| | Depth (mm) | D... | 700 | 700 | 700 | 800 | 800 | 900 | 900 | 1000 |
| Table top connectors | No connector | | | | | | | | | • |
| | Plastic connector | TC | | | | | | | | 52 |
| Wood and wood-based materials | Raw material - EU Timber regulation | EUTR | | | | | | | | • |
| Wooden elements lacquering | Water lacquer UV | UV | | | | | | | | • |
| | Water lacquer | | | | | | | | | - 20 |
| Assembly | Assembled | ASM-F | | | | | | | | • |
| Sample order | SAN SIRO MEETING TABLE LWM RC (W1400 D700 FSP KN BC-BK/SKNO GDF EUTR UV ASM-F) | | | | | | | | | |

- Available as standard (included in basic price)

Price list

san_siro meeting table LWM RD

Round table top.
25 mm table top thickness for Melamine (MFC) and Melamine (MFC) – Organic finish.
27 mm table top thickness for Laminate and Fenix finish.
Base – wooden legs.



SAN SIRO MEETING TABLE LWM RD

| | | | | | | |
|---------|---|------|------|------|------|------|
| H (mm) | 739/714* Melamine (MFC) i Melamine (MFC) – Organic 741/714* Laminate and Fenix | | | | | |
| WT (kg) | 17,2 | 19,7 | 22,5 | 29,1 | 36,9 | 41,2 |

| | | | | | | | |
|--|-------|-----|-----|------|------|------|------|
| Diameter (mm) | DI... | 800 | 900 | 1000 | 1200 | 1400 | 1500 |
| Basic price (EUR) according to table top finishes | | | | | | | |
| Melamine (MFC) | | 427 | 481 | 508 | 520 | 858 | 907 |
| Melamine (MFC) – Organic | | 492 | 554 | 585 | 598 | 987 | 1044 |
| Laminate | | 573 | 643 | 683 | 700 | – | – |
| Fenix NTM® | | 736 | 848 | 882 | 979 | 1565 | 1653 |

| | | | | | | | |
|--------------------------------------|-------------------------------------|------------------|----------------------|--------|--|----|------|
| Table top core | Chipboard | | FSP | | | | • |
| | Melamine (MFC) | | | | | | • |
| Table top finish | Melamine (MFC) – Organic | Edge: | 2 mm glue technology | ①/② | | | • |
| | Laminate | | | | | | • |
| | | Protective edge: | 2 mm glue technology | ①/②-PE | | 85 | |
| Base finish | Fixing part: powder-coated steel | Wooden legs: | Natural beech | | | | • |
| | | | Stained beech | BC-③/① | | | 14 |
| | | | Natural oak | | | | 106 |
| Glides | Plastic glides | | GD | | | | • |
| | Plastic glides with felt | | GDF | | | | ○ |
| Wood and wood-based materials | Raw material - EU Timber regulation | | EUTR | | | | • |
| Wooden elements lacquering | Water lacquer UV | | UV | | | | • |
| | Water lacquer | | | | | | – 20 |
| Assembly | Assembled | | ASM-F | | | | • |

Sample order SAN SIRO MEETING TABLE LWM RD (DI700 FSP KN BC-WS/SKNO GDF EUTR UV ASM-F)

* x/y mm – x: overall height/y: height under table top

① – Please specify table top colour code/solid wood colour code – [see finishes](#)

② – Please specify table top edge finish – [see finishes](#)

③ – Please specify metal colour code – [see finishes](#)

• Available as standard (included in basic price)

○ Available as an option (included in basic price)

san_siro table LWM SQ

Square table top.
25 mm table top thickness for Melamine (MFC) and Melamine (MFC) – Organic finish.
27 mm table top thickness for Laminate and Fenix finish.
Base – wooden legs.



SAN SIRO TABLE LWM SQ

| | | | | | |
|--|---|------------------|---|--------|-----|
| | | H (mm) | 549/524* Melamine (MFC) i Melamine (MFC) – Organic 551/524* Laminate and Fenix | | |
| | | WT (kg) | 14,4 | | |
| Width (mm) | | W... | 700 | | |
| Depth (mm) | | D... | 700 | | |
| Basic price (EUR) according to table top finishes | | | | | |
| Melamine (MFC) | | | | 380 | |
| Melamine (MFC) – Organic | | | | 437 | |
| Laminate | | | | 511 | |
| Fenix NTM® | | | | 591 | |
| Table top core | Chipboard | FSP | | • | |
| | Melamine (MFC) | | | • | |
| Table top finish | Melamine (MFC) – Organic | Edge: | 2 mm glue technology | ①/② | • |
| | Laminate | Protective edge: | 2 mm glue technology | ①/②-PE | 85 |
| | Fenix NTM® | Edge: | 1 mm (matching table top colour) | ① | • |
| Base finish | Fixing part: powder-coated steel | Wooden legs: | Natural beech | | • |
| | | | Stained beech | BC-③/① | 14 |
| | | | Natural oak | | 106 |
| Glides | Plastic glides | GD | | • | |
| | Plastic glides with felt | GDF | | ○ | |
| Wood and wood-based materials | Raw material - EU Timber regulation | EUTR | | • | |
| Wooden elements lacquering | Water lacquer UV | UV | | • | |
| | Water lacquer | | | - 20 | |
| Assembly | Assembled | ASM-F | | • | |
| Sample order | SAN SIRO TABLE LWM SQ (W700 D700 FSP KN BC-WS/SKNO GDF EUTR UV ASM-F) | | | | |

* x/y mm – x: overall height/y: height under table top

① – Please specify table top colour code/solid wood colour code – [see finishes](#)

② – Please specify table top edge finish – [see finishes](#)

③ – Please specify metal colour code – [see finishes](#)

• Available as standard (included in basic price)

○ Available as an option (included in basic price)

Price list

san_siro table LWM RC

Rectangular table top.
25 mm table top thickness for Melamine (MFC) and Melamine (MFC) – Organic finish.
27 mm table top thickness for Laminate and Fenix finish.
Base - wooden legs.



SAN SIRO TABLE LWM RC

| | | | | |
|--------------------------------------|-------------------------------------|--|---|-----|
| | | H (mm) | 549/524* Melamine (MFC) Melamine (MFC) – Organic 551/524* Laminate and Fenix | |
| | | WT (kg) | 24,6 | |
| Width (mm) | | W... | 1400 | |
| Depth (mm) | | D... | 700 | |
| | | Basic price (EUR) according to table top finishes | | |
| Melamine (MFC) | | 429 | | |
| Melamine (MFC) – Organic | | 494 | | |
| Laminate | | 576 | | |
| Fenix NTM® | | 730 | | |
| Table top core | Chipboard | FSP | • | |
| | Melamine (MFC) | | • | |
| | Melamine (MFC) – Organic | Edge: 2 mm glue technology | ①/② | • |
| Table top finish | Laminate | Protective edge: 2 mm glue technology | ①/②-PE | 85 |
| | Fenix NTM® | Edge: 1 mm (matching table top colour) | ① | • |
| Base finish | Fixing part: powder-coated steel | Wooden legs: Natural beech | | • |
| | | Stained beech | BC-③/① | 14 |
| | | Natural oak | | 106 |
| Glides | Plastic glides | | GD | • |
| | Plastic glides with felt | | GDF | ○ |
| Wood and wood-based materials | Raw material - EU Timber regulation | | EUTR | • |
| Wooden elements lacquering | Water lacquer UV | | UV | • |
| | Water lacquer | | | -20 |
| Assembly | Assembled | | ASM-F | • |

Sample order SAN SIRO TABLE LWM RC (W1400 D700 FSP KN BC-WS/SKNO GDF EUTR UV ASM-F)

* x/y mm – x: overall height/y: height under table top

① – Please specify table top colour code/solid wood colour code – [see finishes](#)

② – Please specify table top edge finish – [see finishes](#)

③ – Please specify metal colour code – [see finishes](#)

• Available as standard (included in basic price)

○ Available as an option (included in basic price)

san_siro table LWM RD

Round table top.
25 mm table top thickness for Melamine (MFC) and Melamine (MFC) – Organic finish.
27 mm table top thickness for Laminate and Fenix finish.
Base - wooden legs.



SAN SIRO TABLE LWM RD

| | | | | |
|--------------------------------------|---|------------------|--|--|
| H (mm) | 549/524* Melamine (MFC) i Melamine (MFC) – Organic 551/524* Laminate and Fenix | | | |
| WT (kg) | | | | 13,3 |
| Diameter (mm) | DI... | 700 | | |
| | | | | Basic price (EUR) according to table top finishes |
| Melamine (MFC) | | | | 387 |
| Melamine (MFC) – Organic | | | | 446 |
| Laminate | | | | 520 |
| Fenix NTM® | | | | 604 |
| Table top core | Chipboard | FSP | | • |
| | Melamine (MFC) | | | • |
| | Melamine (MFC) – Organic | Edge: | 2 mm glue technology ①/② | • |
| Table top finish | Laminate | Protective edge: | 2 mm glue technology ①/②-PE | • |
| | Fenix NTM® | Edge: | 1 mm (matching table top colour) ① | • |
| Base finish | Fixing part: powder-coated steel | Wooden legs: | Natural beech Stained beech BC-③/① Natural oak | • 14 106 |
| Glides | Plastic glides | GD | | • |
| | Plastic glides with felt | GDF | | ○ |
| Wood and wood-based materials | Raw material - EU Timber regulation | EUTR | | • |
| Wooden elements lacquering | Water lacquer UV | UV | | • |
| | Water lacquer | | | - 20 |
| Assembly | Assembled | ASM-F | | • |
| Sample order | SAN SIRO TABLE LWM RD (DI700 FSP KN BC-WS/SKNO GDF EUTR UV ASM-F) | | | |

* x/y mm – x: overall height/y: height under table top

① – Please specify table top colour code/solid wood colour code – [see finishes](#)

② – Please specify table top edge finish – [see finishes](#)

③ – Please specify metal colour code – [see finishes](#)

• Available as standard (included in basic price)

○ Available as an option (included in basic price)

Price list

Connector for table tops

Either 2 on short sides or 2 on long sides.

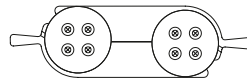

TABLE ACCESSORY TC 1

Basic price (EUR)

26

Sample order TABLE ACCESSORY TC 1

Media ports

| | Media ports configuration | | Standard | Finish | Price (EUR) |
|--|--|--------|----------|--------------------------------------|-------------|
| Media port Netbox Turn Comfort 4M | 3 × power socket 1 × USB charger (type C) | YG012- | ⑧-SM | | 385 |
| | 3 × power socket 1 × HDMI with connection cable 2900 mm length | YG010- | ⑧-SM | ⑧ – FR, GB, GE SM Silver metallic | 860 |

⑧ – Please specify media port standard: CH23, FR, GB, GE

Finishes

Wood

Natural



SKN
Natural
Beech



SKNO
Natural Oak

Stained



2.07Y
Black



2.06S
Slate



S39
Light Grey



2.09S
White



2.0CB
Acacia



SK40
Oak



2.0CC
Walnut

Melamina (MFC)

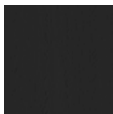

CW
Black
Graphite



MG
Grey Vicenza
Oak

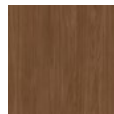

LW
Lincoln
Walnut

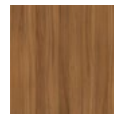

NW
Natural Dijon
Walnut



NZ
Natural
Hickory



HO
Hamilton Oak



ML
Kaisersberg
Oak



NJ
Acacia Light



NH
Maple



MM
Ellmau
Beech



CC
Black



MS
Slate



MP
Platinum



MB
White Grey



NK
Cashmere



BA
Truffle Grey



ST
Smoke Blue

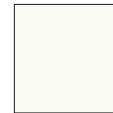

BI
White

Melamina (MFC) – Organic

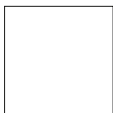

IW
Icy White



OL
Lindberg
Oak



YP
Platinum
Grey

Laminat

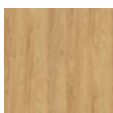

HZ
Natural
Hickory



KU
Hamilton Oak



KT
Lincoln
Walnut



GN
Acacia Light



HE
Kaisersberg
Oak



FC
Grey Vicenza
Oak



HF
Ellmau
Beech



DD
Black



GW
Slate



BW
Platinum

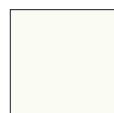

CA
White



FN
White Grey



HC
Cashmere



AA
Came Beige

Finishes

Fenix NTM®



KJ
Nero Ingo



KN
Grigio Bromo



KM
Grigio Antrim



KP
Rosso Jaipur



KR
Verde Comodoro



KO
Blu Fes

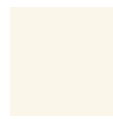

KS
Bianco Kos

Edge

HPL Laminate



2 mm
plastic

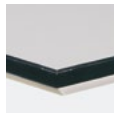

2 mm
plastic on
MDF,
50 mm
chamfered
lipping



2 mm
plastic with
protective
edge

Fenix NTM®



1 mm

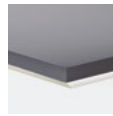

1 mm
50 mm
chamfered
lipping

Metal



**NCS S
2005-
Y60R**
Cashmere
NK



RAL 1024
Ochre Yellow
OY



**RAL 030
50 40**
Vermilion
Red
VR



RAL 6003
Olive Green
OG



RAL 5000
Violet Blue
VB

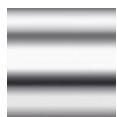

Chrome
CR



**Satin
Chrome**
SCR



**Polished
Aluminium**
POL



RAL 9003
Signal White
WS



RAL 9006
White
Aluminium
WK



Silver 98
SV



DB 703
Iron Mica
IM



RAL 9005
Jet Black
BK

General notes

All specified dimensions are approximate. Subject to minor modifications or differences for reasons of design improvements or for technical reasons.

- W = width
- D = depth
- H = height
- DI = diameter
- SH = seat height
- SH DIN = seat height measured acc. to DIN EN 1335-1
- WT = weight

In compliance with the highest quality standards "Quality is irreplaceable." Guided by this principle, each product line is subjected to stringent quality testing.

Warranty

Manufacturer declares that the products shall be free from defects in material or workmanship.

The warranty is given to the original purchaser only, for normal commercial usage.

Detailed terms of warranty and warranty periods are available at

<https://www.kusch.com/en/warranty>

creva wall price list 2026

Creva Wall

Design: kaschkasch

Free-standing, upholstered wall



CREVA WALL

Free-standing, upholstered wall with a double-sided whiteboard



CREVA WALL WD

Mobile, upholstered wall

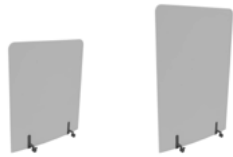

CREVA WALL MOB

Mobile, upholstered wall with a double-sided whiteboard



CREVA WALL WD MOB

Price list

Creva wall

Free-standing, upholstered wall with magnets in side edges.
Magnets allowing wall connection into arrangements.
Boat-shaped base made of powder-coated steel.



CREVA WALL

| | | WT 31,0 kg | WT 371 kg |
|--------------------------------------|--|--|-----------|
| Width (mm) | W1200 | 1200 | |
| Height (mm) | H••• | 1400 | 1800 |
| | | Basic price (EUR) according to upholstery price group | |
| | 2 | 967 | 1164 |
| | 3 | 1017 | 1227 |
| | 4 | 1033 | 1250 |
| | 5 | 1066 | 1290 |
| Panel finish | Upholstery | ⑤ | • |
| Base finish | Powder-coated steel Jet black, RAL 9005 | BC-BK | • |
| Foam | Flame retardant foam | FFR2 | • |
| | Flame retardant foam with fireproof fabric* | FFRF | 200 |
| Wood and wood-based materials | Raw material – EU timber regulation, from certified forests, FSC certificate – authorized companies | FSCMIX | • |
| Assembly | Assembled, cardboard packaging | PACK-ASM | • |
| Sample order | CREVA WALL (W1200 H1400 CUR60111 BC-BK FFR2 FSCMIX PACK-ASM) | | |

* – increased fire resistance parameters for selected upholstery arrangements (DIN 66084 P-a) –
option available for selected upholstery only: Blazer, Main Line Flax, Synergy.

⑤ – Please specify upholstery colour code from selected price group – [see finishes](#)

• Available as standard (included in basic price)

Price list

Creva wall WD

Free-standing, upholstered wall with a double-sided whiteboard and magnets in side edges.
Magnets allowing wall connection into arrangements.
Boat-shaped base and shelves made of powder-coated steel.



CREVA WALL WD

WT 41,6 kg

| | | | |
|--------------------------------------|--|--|-----|
| Width (mm) | W1200 | 1200 | |
| Height (mm) | H1800 | 1800 | |
| | | Basic price (EUR) according to upholstery price group | |
| | 2 | 1551 | |
| | 3 | 1591 | |
| | 4 | 1612 | |
| | 5 | 1630 | |
| Panel finish | Bottom part: Upholstery Upper part: Whiteboard Laminate | ⑤/FU | • |
| Base finish | Powder-coated steel Jet black, RAL 9005 | BC-BK | • |
| Shelf finish | Powder-coated steel Jet black, RAL 9005 | SF-BK | • |
| Foam | Flame retardant foam | FFR2 | • |
| | Flame retardant foam with fireproof fabric* | FFRF | 146 |
| Wood and wood-based materials | Raw material – EU timber regulation | EUTR | • |
| Assembly | Assembled, cardboard packaging | PACK-ASM | • |
| Sample order | CREVA WALL WD (W1200 H1800 CUR60111/FU BC-BK SF-BK FFR2 EUTR PACK-ASM) | | |

* – increased fire resistance parameters for selected upholstery arrangements (DIN 66084 P-a) –
option available for selected upholstery only: Blazer, Main Line Flax, Synergy.

⑤ – Please specify upholstery colour code from selected price group – [see finishes](#)

- Available as standard (included in basic price)

Creva mobile wall

Mobile, upholstered wall with magnets in side edges.
Magnets allowing wall connection into arrangements.
Base - 2 feet made of powder-coated steel, 4 castors, including 2 with brakes.

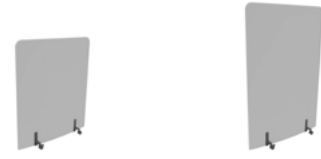

CREVA WALL MOB

| | | WT 25,5 kg | WT 31,6 kg |
|--------------------------------------|--|--|------------|
| Width (mm) | W1200 | 1200 | |
| Height (mm) | H••• | 1400 | 1800 |
| | | Basic price (EUR) according to upholstery price group | |
| | 2 | 1007 | 1204 |
| | 3 | 1057 | 1267 |
| | 4 | 1073 | 1290 |
| | 5 | 1106 | 1330 |
| Panel finish | Upholstery | ⑤ | • |
| Base finish | Powder-coated steel Jet black, RAL 9005 | BC-BK | • |
| Foam | Flame retardant foam | FFR2 | • |
| | Flame retardant foam with fireproof fabric* | FFRF | 200 |
| Wood and wood-based materials | Raw material – EU timber regulation, from certified forests, FSC certificate – authorized companies | FSCMIX | • |
| Assembly | Assembled, cardboard packaging | PACK-ASM | • |
| Sample order | CREVA WALL MOB (W1200 H1400 CUR60111 BC-BK FFR2 FSCMIX PACK-ASM) | | |

* – increased fire resistance parameters for selected upholstery arrangements (DIN 66084 P-a) –
option available for selected upholstery only: Blazer, Main Line Flax, Synergy.

⑤ – Please specify upholstery colour code from selected price group – [see finishes](#)

• Available as standard (included in basic price)

Price list

Creva mobile wall WD

Mobile, upholstered wall with a double-sided whiteboard and magnets in side edges.
Magnets allowing wall connection into arrangements.
Boat-shaped shelves made of powder-coated steel.
Base - 2 feet made of powder-coated steel, 4 castors, including 2 with brakes.



CREVA WALL WD MOB

WT 41,6 kg

| | | |
|-------------|-------|--|
| Width (mm) | W1200 | 1200 |
| Height (mm) | H1800 | 1800 |
| | | Basic price (EUR) according to upholstery price group |
| | | 2 |
| | | 1591 |
| | | 3 |
| | | 1631 |
| | | 4 |
| | | 1652 |
| | | 5 |
| | | 1670 |

| | | | | |
|--------------------------------------|---|---------------------------------|----------|-----|
| Panel finish | Bottom part: Upholstery | Upper part: Whiteboard Laminate | ⑤/FU | • |
| Base finish | Powder-coated steel | Jet black, RAL 9005 | BC-BK | • |
| Shelf finish | Powder-coated steel | Jet black, RAL 9005 | SF-BK | • |
| Foam | Flame retardant foam | | FFR2 | • |
| | Flame retardant foam with fireproof fabric* | | FFRF | 146 |
| Wood and wood-based materials | Raw material – EU timber regulation | | EUTR | • |
| Assembly | Assembled, cardboard packaging | | PACK-ASM | • |

Sample order CREVA WALL WD MOB (W1200 H1800 CUR60111/FU BC-BK SF-BK FFR2 EUTR PACK-ASM)

* – increased fire resistance parameters for selected upholstery arrangements (DIN 66084 P-a) –
option available for selected upholstery only: Blazer, Main Line Flax, Synergy.

⑤ – Please specify upholstery colour code from selected price group – [see finishes](#)

• Available as standard (included in basic price)

Finishes

Laminate



FU
White Gloss
(whiteboard)

Metal



RAL 9005
Jet Black
BK

General notes

All specified dimensions are approximate. Subject to minor modifications or differences for reasons of design improvements or for technical reasons.

- WT = weight

In compliance with the highest quality standards "Quality is irreplaceable." Guided by this principle, each product line is subjected to stringent quality testing.

Only the products marked in this document are FSC® (FSC®-C120977). Sale of products that meet the FSC® requirements is possible only by Nowy Styl Sp. z o.o., Nowy Styl Nederland B.V. and Kusch + Co GmbH.



The FSC® certificate applies to responsible forest management and the entire flow of raw materials from the forest to the customer. Each stage of the chain is monitored in terms of social, ecological and economic performance. The product with the FSC® label gives customers a guarantee that the wood used for the production of the product comes from sources managed in a sustainable manner.

Warranty

Manufacturer declares that the products shall be free from defects in material or workmanship. The warranty is given to the original purchaser only, for normal commercial usage. Detailed terms of warranty and warranty periods are available at <https://www.kusch.com/en/warranty>

Carts

CART KU 1



CART KU 1

CART KU 2



CART KU 2

CART KU 5



CART KU 5

CART KU 3



CART KU 3

CART KU 4



CART KU 4

CART KU 6



CART KU 6

Price list

Carts



| CART KU 1 | CART KU 2 | CART KU 5 |
|--|---------------------------------------|--|
| Inclined frame permits easy handling, 4 wheels | Safety handles, 2 solid rubber wheels | For lying tables, length-adjustable metal frame suited for tables up to a length of 200 cm and a width of 120 cm, carrying surface made of a two-part chipboard with black plastic lipping and antiskid covering, 4 castors (2 with brake) |
| Basic price (EUR) | | |
| 612 | 520 | 924 |
| Finish | Powder-coated steel | Jet black RAL 9005 BK |
| | | Gentian blue RAL 5010 GB |
| | | • |
| | | — |
| | | • |
| | | — |

Sample order CART KU 1 (BK)

- Available as standard (included in basic price)

Price list

CART KU 3

4 wheels.



CART KU 3

| Width (mm) | W*** | 625 | 600 | 600 | 550 | 550 |
|-------------------|------|-----|-----|-----|-----|-----|
| Depth (mm) | D*** | 600 | 600 | 550 | 600 | 550 |
| Basic price (EUR) | | | | | | |
| 333 | | | | | | |

| Line | Model | | | | | |
|-----------|---|---------------------|----|---|---|---|
| V-Care | With chair on sled frame with armrests (CFS) and without armrests (CFS) | — | • | — | — | — |
| | With chair on 4 legs with armrests (4LA) and without armrests (4L) | • | — | — | — | — |
| Trio | With chair on sled frame with armrests (CFA) and without armrests (CFS) | — | • | — | — | — |
| | With chair on 4 legs with armrests (4LA) and without armrests (4L) | — | • | — | — | — |
| Duo | With chair on 4 legs with linking, with armrests (4LA IN) and without armrests (4L IN) | • | — | — | — | — |
| | With chair on 4 legs with armrests (4LA) and without armrests (4L) | — | — | • | — | — |
| Paxo | With chair on sled frame without armrests (CFS) | — | • | — | — | — |
| | With chair on 4 legs without armrests (4L) | — | • | — | — | — |
| Luca | With chair on 4 legs with armrests (4LA) and without armrests (4L) | • | — | — | — | — |
| uni_verso | With chair on 4 legs with armrests (4LA) and without armrests (4L) | • | — | — | — | — |
| | With chair on sled frame without armrests (CFS) | — | • | — | — | — |
| Scorpii | With chair on 4 legs with armrests (4LA) and without armrests (4L) | — | — | • | — | — |
| Yara | With chair on 4 legs with armrests (4LA) and without armrests (4L) | — | — | • | — | — |
| Ona Plaza | With chair on 4 legs with armrests (4LA) | — | • | — | — | — |
| | With chair on cantilever frame with armrests (CFA) | — | • | — | — | — |
| Papilio | With chair on cantilever frame without armrests (CF) | — | — | — | • | — |
| | With chair on cantilever frame with armrests (CFA) | — | • | — | — | — |
| sao paulo | With chair on cantilever frame with armrests (CFA) | • | — | — | — | — |
| Hola | With chair on 4 legs without armrests (4L) | — | — | — | — | • |
| Arn | With chair on 4 legs without armrests (4L) | — | — | — | — | • |
| Smile | With chair on 4 legs with armrests (4LA) and without armrests (4L) | — | • | — | — | — |
| Embla | With chair on 4 legs with armrests (4LA) and without armrests (4L) | — | • | — | — | — |
| beWise | With chair on 4 legs with armrests (4LA) and without armrests (4L) | • | — | — | — | — |
| Finish | Powder-coated | Jet Black, RAL 9005 | BK | | • | |

Sample order CART KU 3 (W625 D600 BK)

• Available as standard (included in basic price)

CART KU 4

With 2 supporting plates in order to create an inclined plane for greater stacking capacity, 4 castors.



CART KU 4

| Width (mm) | W... | 500 | 565 | 600 | 600 | 625 | 550 |
|-------------------|------|-----|-----|-----|-----|-----|-----|
| Depth (mm) | D... | 600 | 580 | 550 | 600 | 600 | 550 |
| Basic price (EUR) | | | | | | | |
| 509 | | | | | | | |

| Line | Model | | | | | | |
|------------------------|---|---------------------|----|---|---|---|---|
| V-Care | With chair on sled frame with armrests (CFSA) and without armrests (CFS) | — | — | — | ● | — | — |
| | With chair on 4 legs with armrests (4LA) and without armrests (4L) | — | — | — | — | ● | — |
| Trio | With chair on sled frame with armrests (CFA) and without armrests (CFS) | — | — | ● | — | — | — |
| | With chair on 4 legs with armrests (4LA) and without armrests (4L) | — | — | ● | — | — | — |
| Duo | With chair on 4 legs with linking, with armrests (4LA IN) and without armrests (4L IN) | — | — | — | — | ● | — |
| | With chair on 4 legs with armrests (4LA) and without armrests (4L) | — | — | ● | — | — | — |
| Paxo | With chair on sled frame without armrests (CFS) | — | — | — | ● | — | — |
| | With chair on 4 legs without armrests (4L) | — | — | — | ● | — | — |
| Luca | With chair on 4 legs with armrests (4LA) and without armrests (4L) | — | — | — | — | ● | — |
| Dedicated to uni_verso | With chair on 4 legs with armrests (4LA) and without armrests (4L) | — | — | — | — | — | ● |
| | With chair on sled frame without armrests (CFS) | — | — | — | — | — | ● |
| Scorpii | With chair on 4 legs with armrests (4LA) and without armrests (4L) | — | — | ● | — | — | — |
| Yara | With chair on 4 legs with armrests (4LA) and without armrests (4L) | — | — | ● | — | — | — |
| Ona Plaza | With chair on 4 legs with armrests (4LA) | — | — | ● | — | — | — |
| | With chair on cantilever frame with armrests (CFA) | — | ● | — | — | — | — |
| Papilio | With chair on cantilever frame without armrests (CF) | ● | — | — | — | — | — |
| | With chair on cantilever frame with armrests (CFA) | — | — | — | ● | — | — |
| sao paulo | With chair on cantilever frame with armrests (CFA) | — | — | — | — | ● | — |
| Hola | With chair on 4 legs without armrests (4L) | — | — | — | — | — | ● |
| Arn | With chair on 4 legs without armrests (4L) | — | — | — | — | — | ● |
| Smile | With chair on 4 legs with armrests (4LA) and without armrests (4L) | — | — | — | ● | — | — |
| Embla | With chair on 4 legs with armrests (4LA) and without armrests (4L) | — | — | — | ● | — | — |
| beWise | With chair on 4 legs with armrests (4LA) and without armrests (4L) | — | — | — | — | ● | — |
| Finish | Powder-coated | Jet Black, RAL 9005 | BK | ● | | | |
| Sample order | CART KU 4 (W500 D600 BK) | | | | | | |

- Available as standard (included in basic price)

Price list

CART KU 6

Cart for storing and transporting chairs, equipped with castors, front castors fitted with brakes.



| | | CART KU 6 | |
|---------------------|--------------------------|--|-----|
| Width (mm) | W... | | 752 |
| Depth (mm) | D... | | 582 |
| | | Basic price (EUR) | |
| | | 175 | |
| Dedicated to | Linia | Model | |
| | V-Care | With chair on sled frame with armrests (CFSA) and without armrests (CFS) | • |
| | | With chair on 4 legs without armrests (4L) | • |
| | Trio | With chair on sled frame without armrests (CFS) | • |
| | | With chair on 4 legs with armrests (4LA) and without armrests (4L) | • |
| | Duo | With chair on 4 legs with armrests (4LA) and without armrests (4L) | • |
| | Paxo | With chair on sled frame without armrests (CFS) | • |
| | | With chair on 4 legs without armrests (4L) | • |
| | Luca | With chair on 4 legs without armrests (4L) | • |
| | uni_verso | With chair on 4 legs with armrests (4LA) and without armrests (4L) | • |
| | Scorpii | With chair on 4 legs with armrests (4LA) and without armrests (4L) | • |
| | Yara | With chair on 4 legs with armrests (4LA) and without armrests (4L) | • |
| | Ona Plaza | With chair on 4 legs with armrests (4LA) | • |
| | | With chair on cantilever frame with armrests (CFA) | • |
| | Papilio | With chair on cantilever frame without armrests (CF) | • |
| | sao paulo | With chair on cantilever frame with armrests (CFA) | • |
| | Hola | With chair on 4 legs without armrests (4L) | • |
| | Arn | With chair on 4 legs without armrests (4L) | • |
| | Smile | With chair on 4 legs with armrests (4LA) and without armrests (4L) | • |
| | Embla | With chair on 4 legs with armrests (4LA) and without armrests (4L) | • |
| | beWise | With chair on 4 legs with armrests (4LA) and without armrests (4L) | • |
| Finish | Stal malowana proszkowo | Jet Black, RAL 9005 | BL |
| Sample order | CART KU 6 (W752 D582 BL) | | |

- Available as standard (included in basic price)

Finishes

Metal



RAL 9005
Jet Black
BK, BL



RAL 5010
Gentian Blue
GB

General notes

All specified dimensions are approximate. Subject to minor modifications or differences for reasons of design improvements or for technical reasons. In compliance with the highest quality standards

“Quality is irreplaceable.” Guided by this principle, each product line is subjected to stringent quality testing.

Warranty

Manufacturer declares that the products shall be free from defects in material or workmanship. The warranty is given to the original purchaser only, for normal commercial usage. Detailed terms of warranty and warranty periods are available at <https://www.kusch.com/en/warranty>

materials 2026

Finishes

Wood

Natural

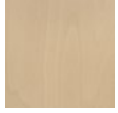

SKNB
Natural Beech

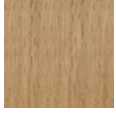

SKNO
Natural Oak

Stained



2.07Y
Black



2.06S
Slate



S39
Light Grey

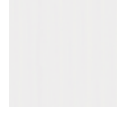

2.09S
White



2.0CB
Acacia



SK40
Oak



2.0CC
Walnut

Veneer

for furniture



KNB
Walnut



KBU
Beech



KEI
Oak

for seating



SKNO
Natural Oak

Laminate for seating

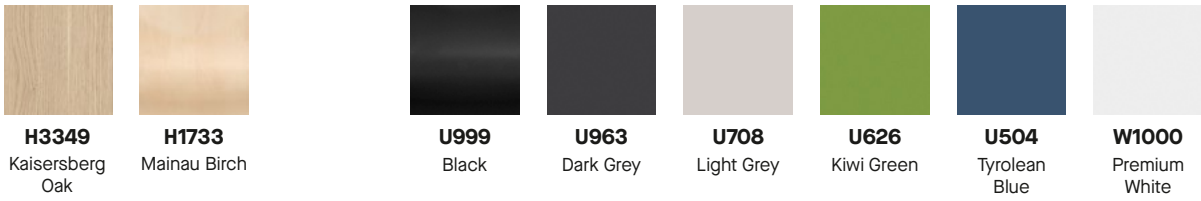

Laminate for table tops



for Creva soft seating, Scorpii:

Compact Laminate

for tables in benches and writing tablets:



Topalit®

for Trio



Fenix NTM®

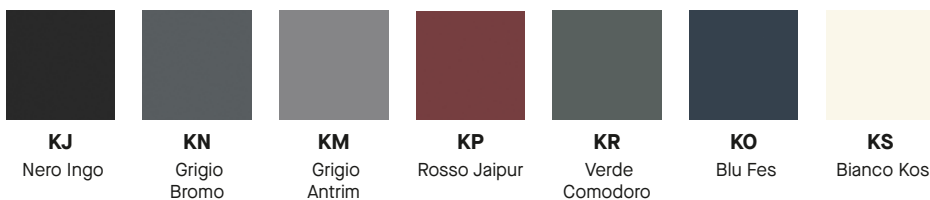

Edge

HPL Laminate

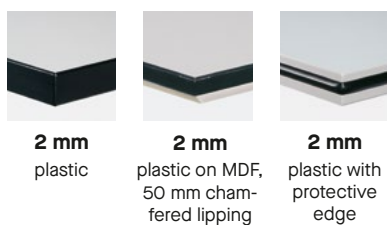

Fenix NTM®

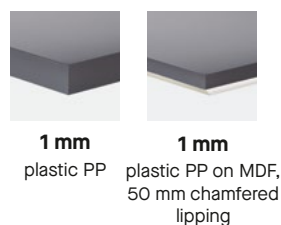

Veneer



Finishes

Plastic

¡Hola!

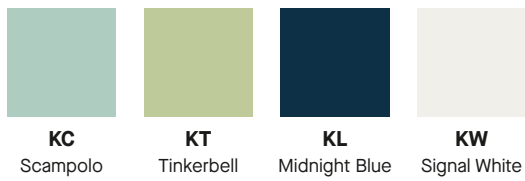
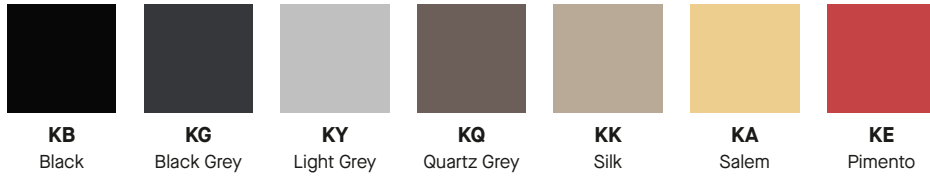

Paxo



Plastic

Arn



Volpino

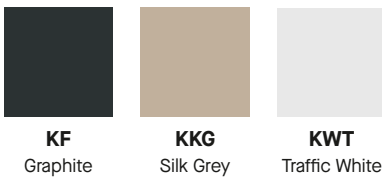

uni_verso

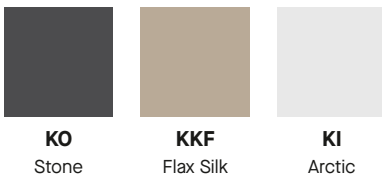

V-care armrest



Polyurethane

for shell V-Care



for Terminal



for 8000



for V-Travel

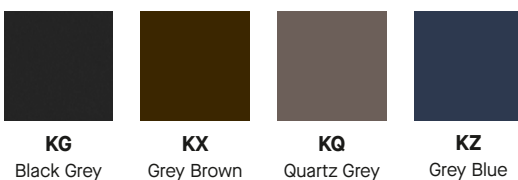

Metal surface finishing

Metal



**NCS S
2005-Y60R**
Cashmere
NK



RAL 1024
Ochre Yellow
OY



**RAL 030 50
40**
Vermilion Red
VR



RAL 6003
Olive Green
OG



RAL 5000
Violet Blue
VB



RAL 9003
Signal White
WS



RAL 9016
Traffic White
WT



**Silver
Aluminium**
SA



Silk
KSK



RAL 9006
White
Aluminium
WK



Silver 98
SV



DB 703
Iron Mica
IM



RAL 9005
Jet Black
BK, BL



RAL 9011
Graphite Black
BLK



Chrome
CR



**Satin
Chrome**
SCR



**Polished
Aluminium**
POL



**Stainless
Steel**
STS



**Anodised
Aluminium
Silver matt**
ASAM



**Anodised
Aluminium
Silver
bright**
ASAG



**Black Matt
Anode**
AC



**Natural
Anode**
AA

BO | Boogie

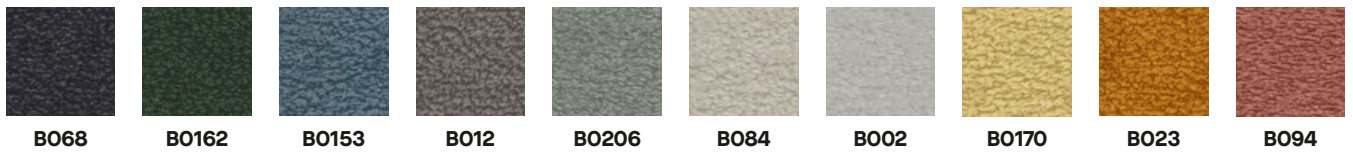

CUR | Cura



CUR | Cura

EXTENDED

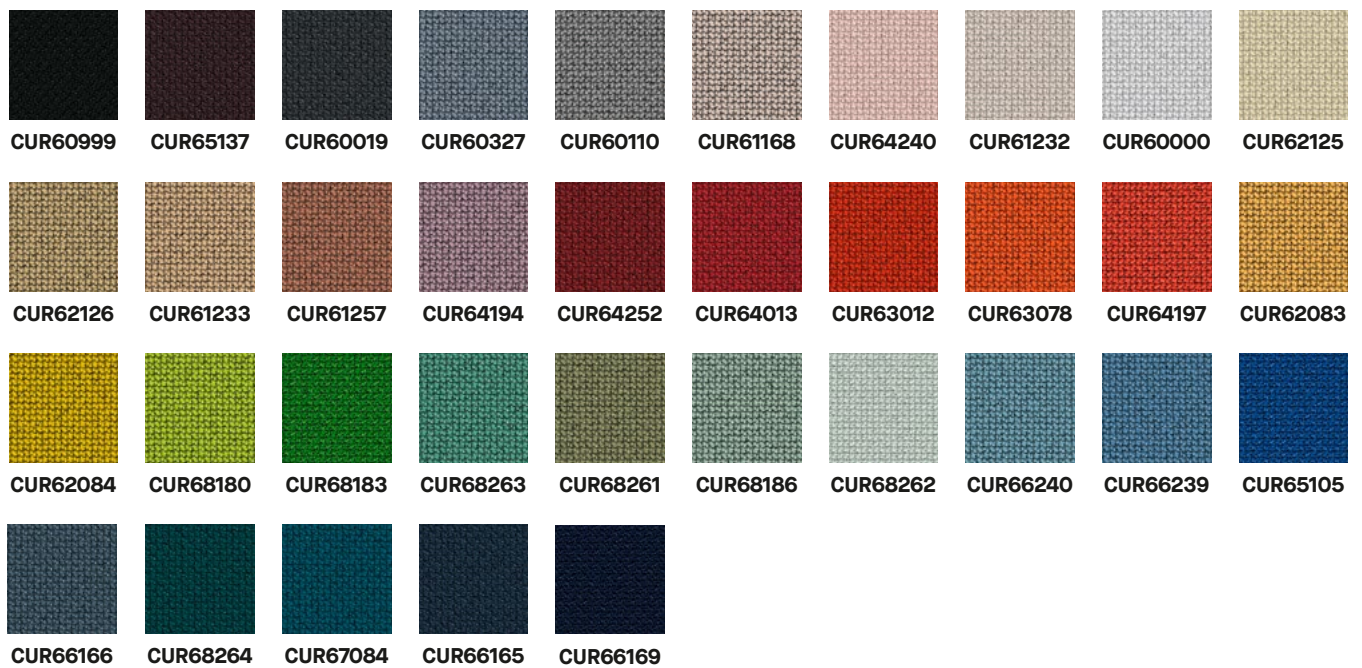

CUL | Cura Loop

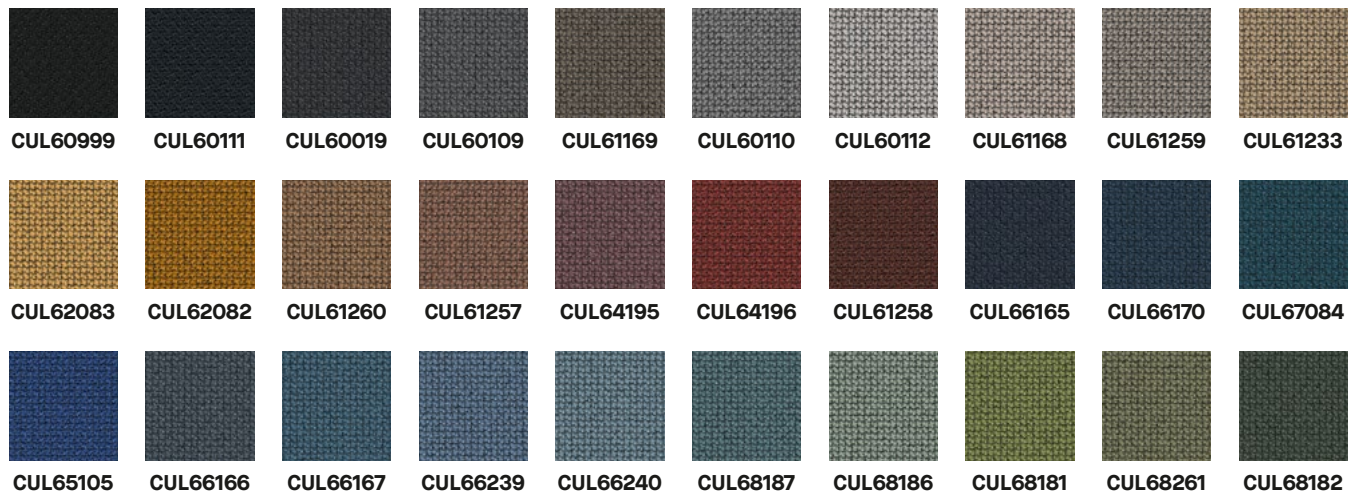

HM | Home

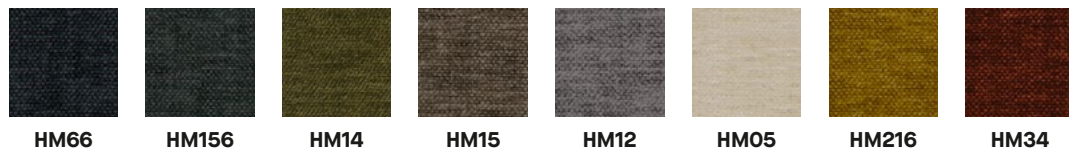

YN | Urban



XR | Xtreme



XR | Xtreme

EXTENDED



VL | Valencia



VL | Valencia

EXTENDED

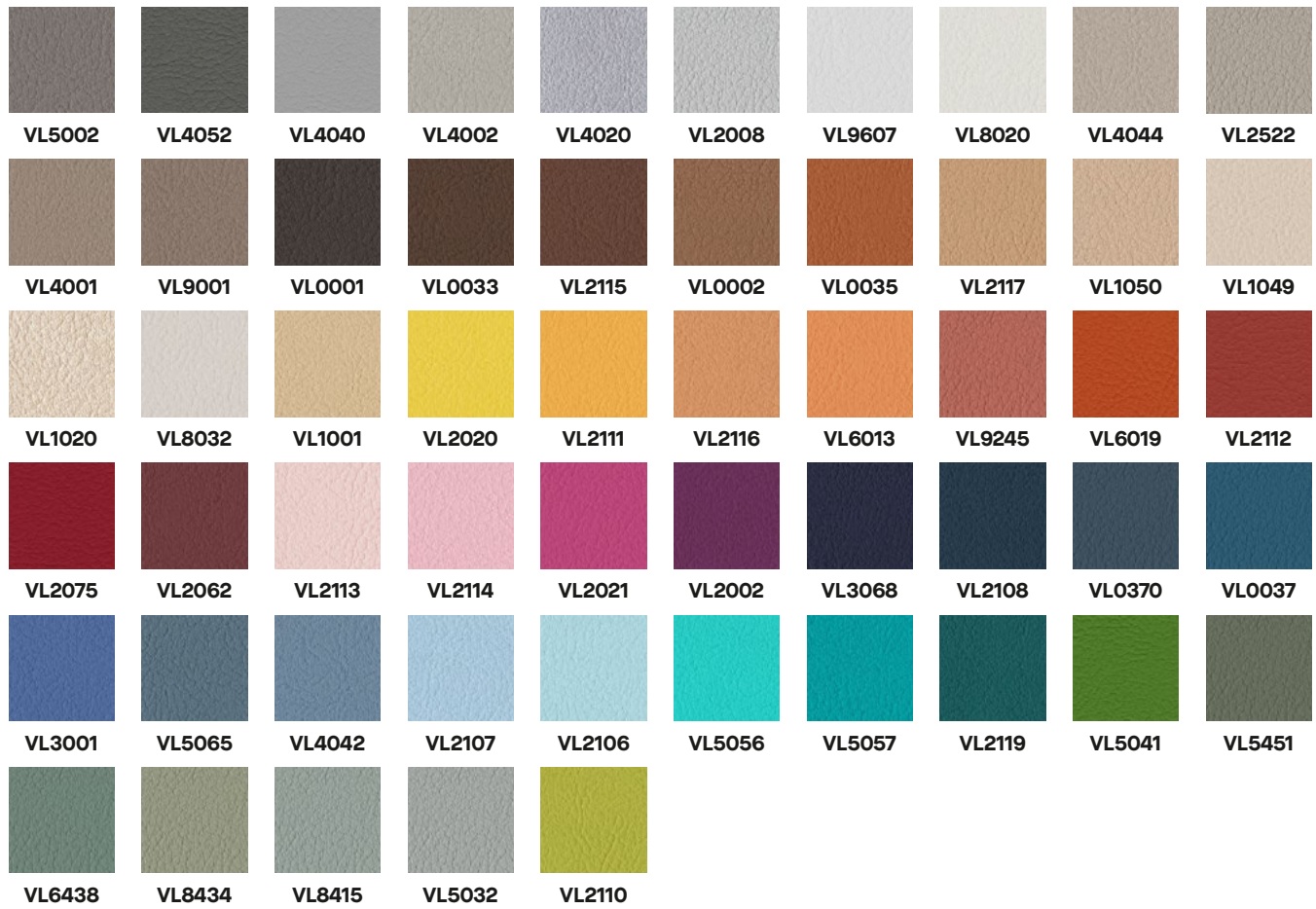

CG | Chili

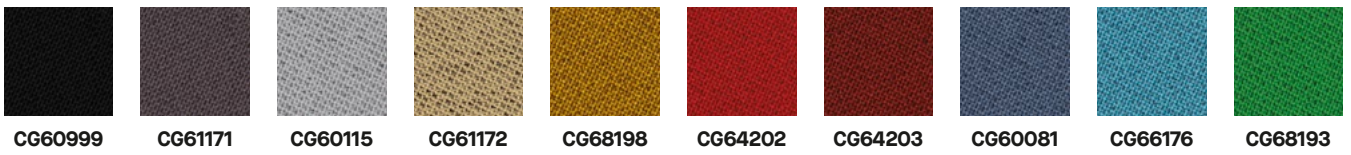

MU | Moulin-Fr

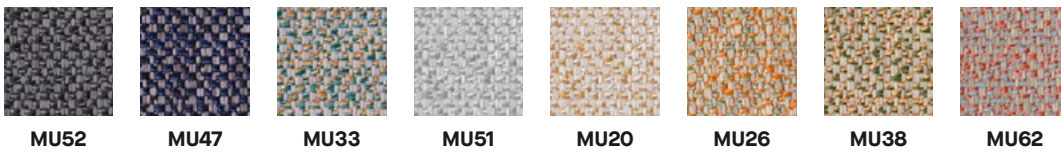

SX | Silvertex

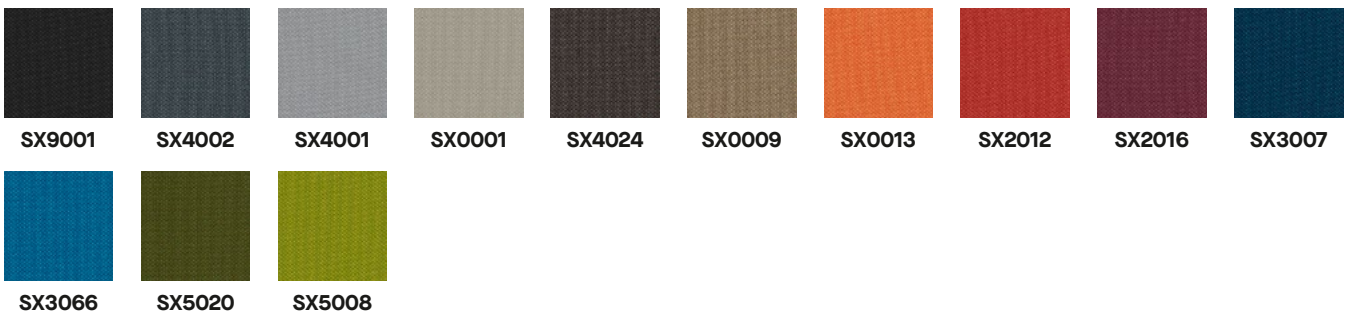

SX | Silvertex

EXTENDED



HQ | Harlequin

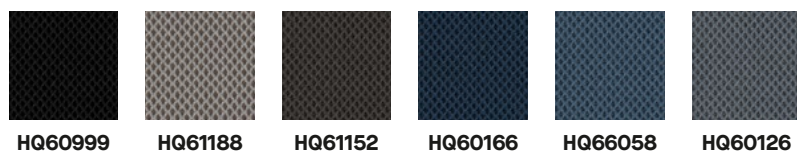

STG/STMG | Step/Step Melange













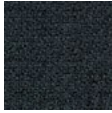
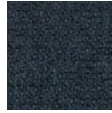

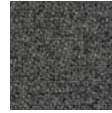











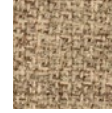
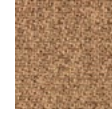

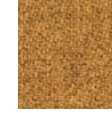

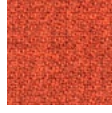
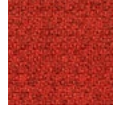

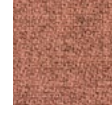
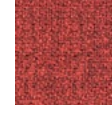
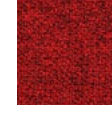
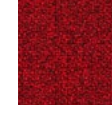
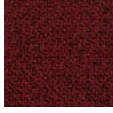

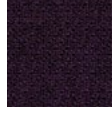
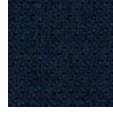

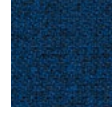

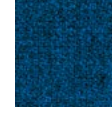
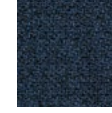
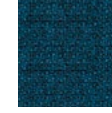

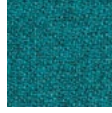

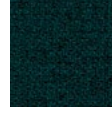

STG | Step

EXTENDED

| | | | | | | | | | | |
|----------|----------|----------|----------|----------|----------|----------|----------|----------|----------|--|
| | | | | | | | | | | |
| STG60021 | STG66019 | STG60092 | STG60090 | STG60011 | STG61793 | STG60091 | STG60004 | STG60745 | | |
| | | | | | | | | | | |
| STG61788 | STG61149 | STG61789 | STG61791 | STG61103 | STG68165 | STG61787 | STG68701 | STG62073 | STG62744 | |
| | | | | | | | | | | |
| STG62746 | STG63739 | STG64767 | STG63736 | STG63738 | STG63082 | STG64179 | STG64013 | STG64178 | | |
| | | | | | | | | | | |
| STG64770 | STG64159 | STG65023 | STG65047 | STG65018 | STG66149 | STG66150 | STG66151 | STG67735 | STG60746 | |
| | | | | | | | | | | |
| STG67073 | STG67072 | STG67007 | STG66763 | STG66764 | STG66765 | STG66148 | STG66152 | | | |
| | | | | | | | | | | |
| STG68158 | STG68121 | STG68161 | STG68700 | STG68162 | STG68159 | STG68163 | STG68799 | STG68798 | STG68118 | |

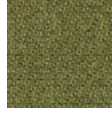
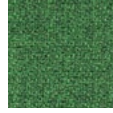
STMG | Step Melange

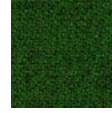
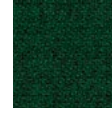
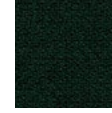
EXTENDED

| | | | | | | | | | |
|--|---|---|---|---|---|---|---|---|---|
|  |  |  |  |  |  |  |  |  |  |
| STMG60021 | STMG66019 | STMG66265 | STMG60092 | STMG60011 | STMG66152 | STMG60090 | STMG61152 | STMG61291 | STMG61289 |
|  |  |  |  |  |  |  |  |  |  |
| STMG61293 | STMG61149 | STMG60345 | STMG61287 | STMG61286 | STMG61288 | STMG62143 | STMG63136 | STMG62144 | STMG62146 |
|  |  |  |  |  |  |  |  |  |  |
| STMG63139 | STMG63082 | STMG63138 | STMG63137 | STMG61151 | STMG64270 | STMG64267 | STMG64178 | STMG64179 | STMG64013 |
|  |  |  |  |  |  |  |  |  |  |
| STMG64159 | STMG65023 | STMG65047 | STMG65011 | STMG65018 | STMG66149 | STMG66150 | STMG66151 | STMG66148 | STMG66264 |
|  |  |  |  |  |  |  |  |  |  |
| STMG66263 | STMG66018 | STMG67072 | STMG67007 | STMG68158 | STMG67135 | STMG60346 | STMG68118 | STMG68298 | STMG68163 |
|  |  |  |  |  |  |  |  |  |  |
| STMG62073 | STMG68299 | STMG68300 | STMG68159 | STMG68162 | STMG68120 | STMG68161 | STMG68121 | STMG68165 | STMG68301 |

FC | Focus Royal

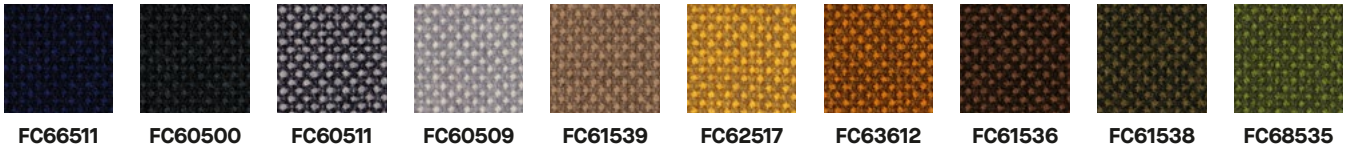

OOC | Oceanic

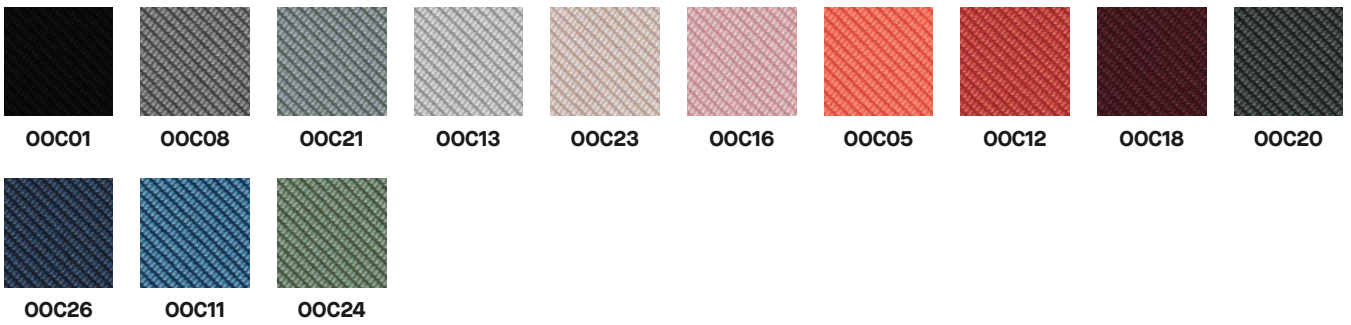

OOC | Oceanic

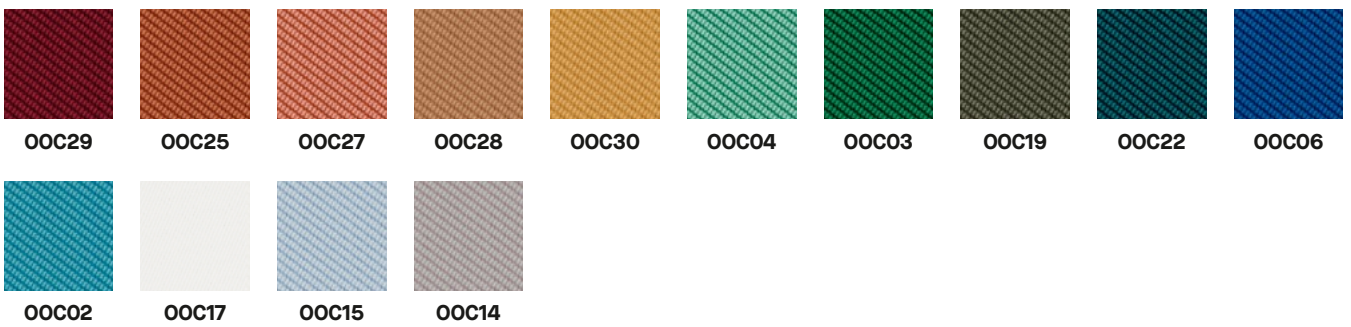

EXTENDED

NF | skai® Parotega



NF | skai® Parotega



EXTENDED

MLF | Main Line Flax



CUZ | Blazer

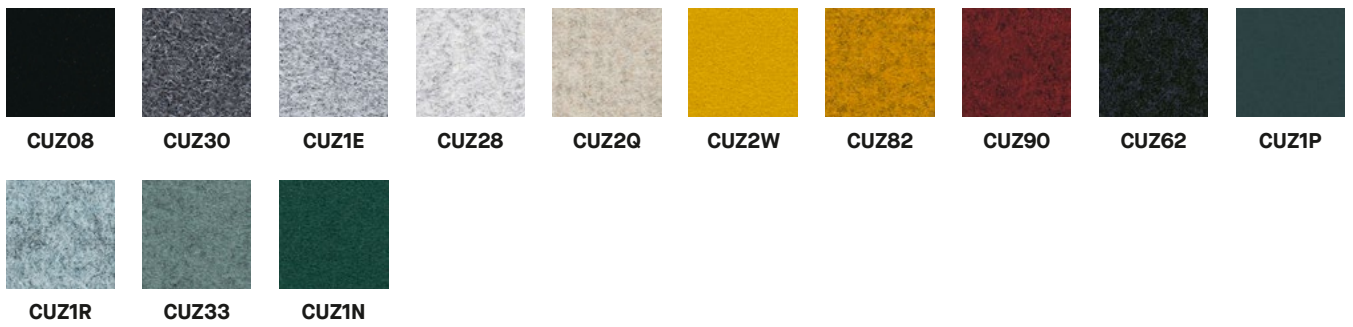

CUZ | Blazer

EXTENDED



LDS | Synergy



LDS | Synergy

EXTENDED

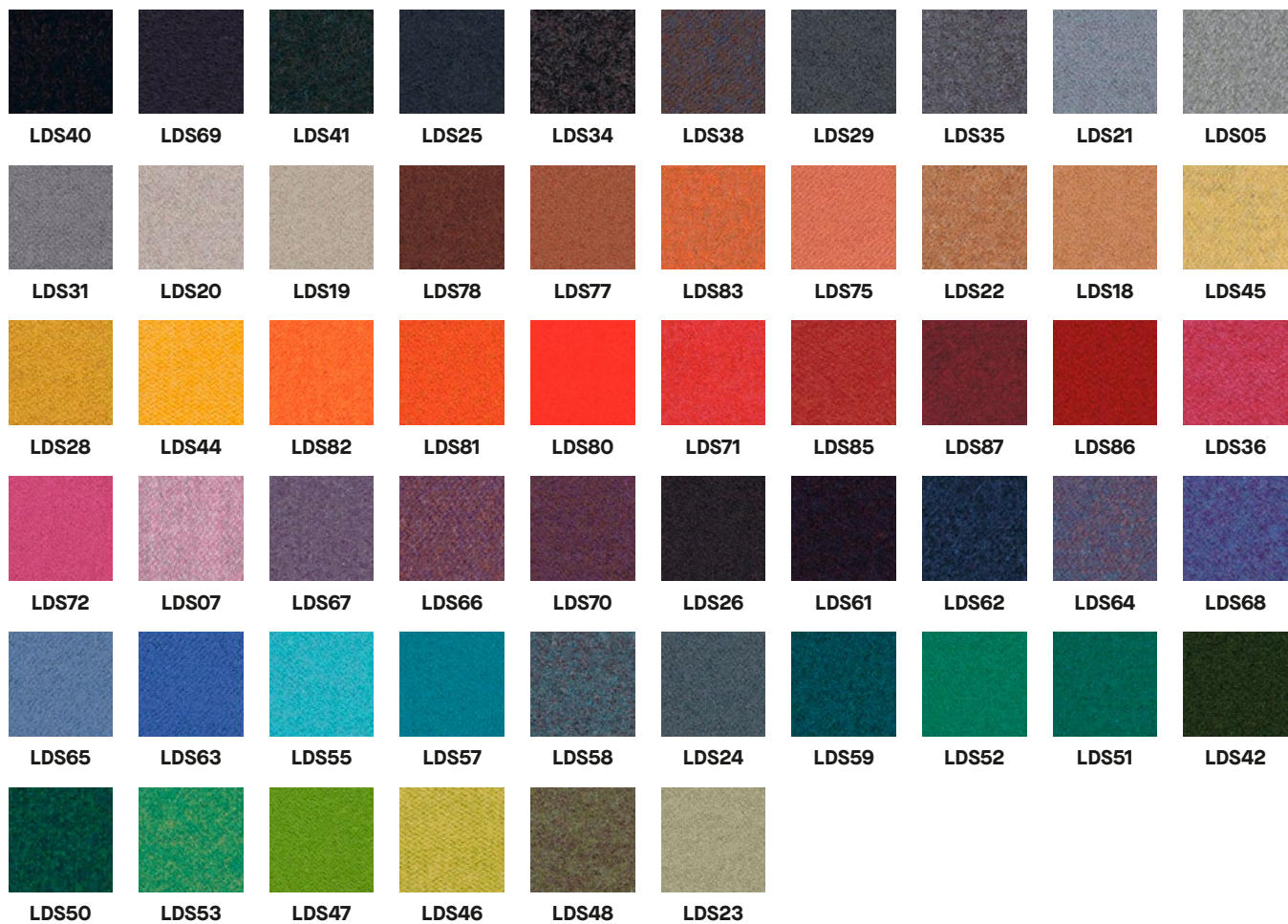

RX | Remix 3



RX | Remix 3

EXTENDED

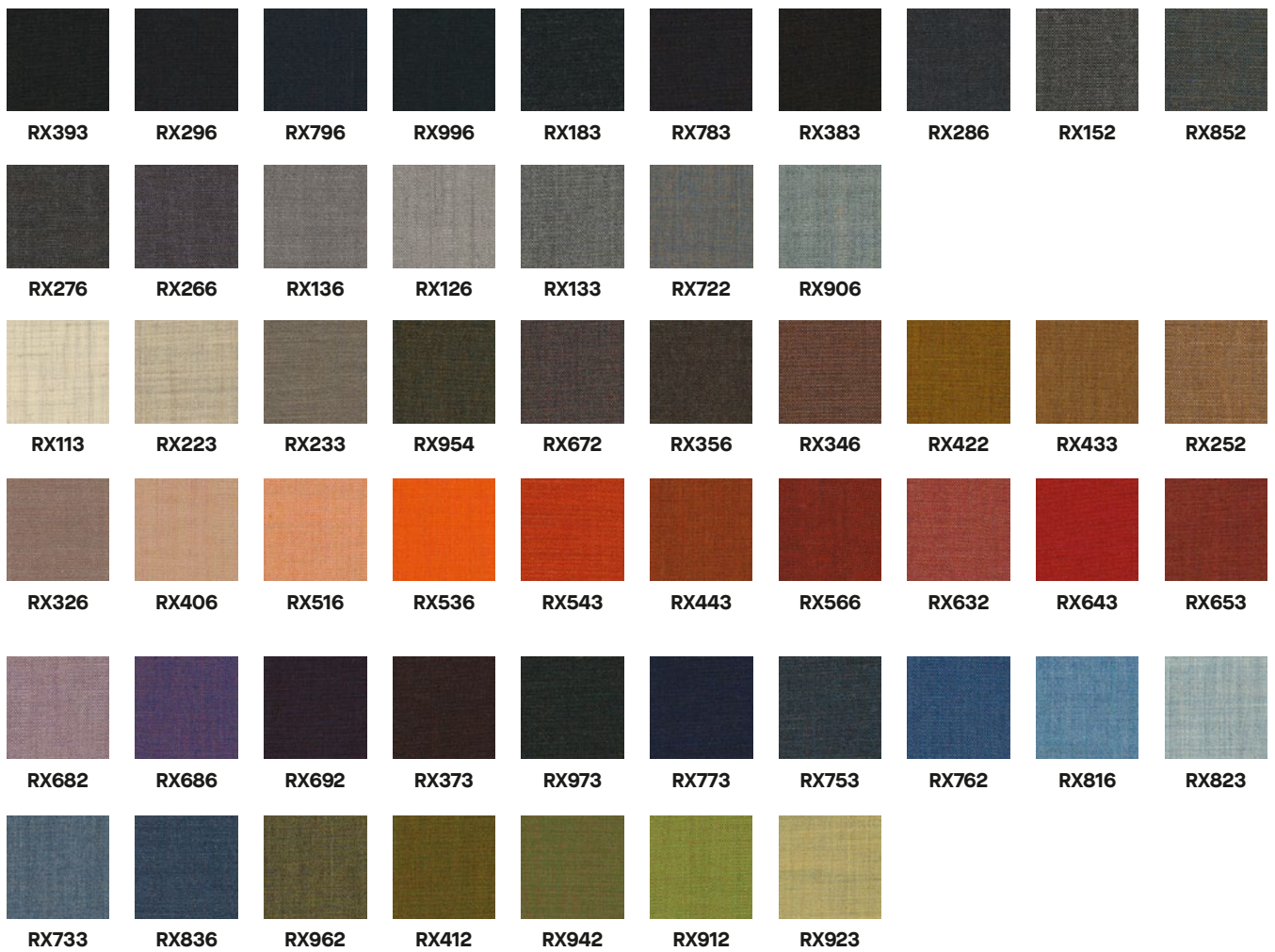

AN | Arona Leather



NAP | Nappa Leather



KR.4716.10 | Mesh

for Papilio

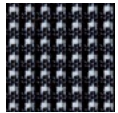

KR.4716.10

Felt

for Njord



FK01
Anthracite

Upholstery materials

Technical specifications

2 PRICE GROUP

| | |
|-----------------|---|
| BOOGIE BO | <p>Composition: 100 % polyester</p> <p>Weight: 478 g/m²</p> <p>Abrasion resistance: ≥100 000 Martindale cycles</p> <p>Pilling: EN ISO 12945-2 (4-5)</p> <p>Colour fastness to light: EN ISO 105-B02 (5)</p> <p>Colour fastness to rubbing: EN ISO 105-X12 (wet: 4-5 / dry: 5)</p> <p>Flammability: BS 5852 Source 0</p> <p>Other: OEKO-TEX® STANDARD 100 certificate</p> |
| CURA CUR | <p>Composition: 100% post-consumer recycled polyester</p> <p>Weight: 300 g/m²</p> <p>Abrasion resistance: 100 000 Martindale cycles</p> <p>Pilling: EN ISO 12945-2 (4-5)</p> <p>Colour fastness to light : EN ISO 105-B02 (5-8)</p> <p>Colour fastness to rubbing: EN ISO 105-X12 (wet: 4-5 / dry: 4-5)</p> <p>Flammability: EN 1021-1, EN 1021-2, Calif. Bull. 117E</p> <p>Other: OEKO-TEX® STANDARD 100 certificate, EU Ecolabel certificate</p> |
| CURA LOOP CUL | <p>Composition: 100% post-consumer recycled polyester PES (100% textile waste)</p> <p>Weight: 300 g/m²</p> <p>Abrasion resistance: 100 000</p> <p>Pilling: EN ISO 12945-2 (4-5)</p> <p>Colour fastness to light : EN ISO 105-B02 (6-8)</p> <p>Colour fastness to rubbing: EN ISO 105-X12 (wet: 4-5 / dry: 4-5)</p> <p>Flammability: EN 1021-1, EN 1021-2, UNI 9175 Classe 1 IM, Calif. Bull. 117E</p> <p>Other: OEKO-TEX® STANDARD 100 certificate, EU Ecolabel certificate</p> |
| HOME HM | <p>Composition: 100% polyester</p> <p>Weight: 420 g/m²</p> <p>Abrasion resistance: ≥ 100 000 Martindale cycles</p> <p>Pilling: EN ISO 12945-2 (4)</p> <p>Colour fastness to light: EN ISO 105-B02 (4)</p> <p>Colour fastness to rubbing: EN ISO 105-X12 (wet: 4-5 / dry: 4-5)</p> <p>Flammability: BS 5852 Source 0</p> <p>Other: OEKO-TEX® STANDARD 100 certificate</p> |
| URBAN YN | <p>Composition: 100% post-consumer recycled polyester, non metallic dyestuffs</p> <p>Weight: 340 g/m² ±5%</p> <p>Abrasion resistance: ≥100 000 Martindale cycles</p> <p>Colour fastness to light : EN ISO 105-B02 (6)</p> <p>Colour fastness to rubbing: EN ISO 105-X12 (wet: 4 / dry: 4)</p> <p>Flammability: EN 1021-1, EN 1021-2, BS 5852 Crib 5, BS 7176 medium hazard, DIN 4102 B1, NF D 60-013 AM 18, ÖNORM A 3800-1 (over CMHR 58 kg/m³ Foam), UNI 9175 Classe 1 IM</p> <p>Other: EU Ecolabel certificate, OEKO-TEX® STANDARD 100 certificate</p> |
| VALENCIA VL | <p>Composition: upper layer: 100% PERMABLOK3® (vinyl / urethane) bottom layer: 100% Hi-Loft™ polyester</p> <p>Weight: 650 g/m²</p> <p>Abrasion resistance: 300 000 Martindale cycles</p> <p>Colour fastness to light : EN ISO 105-B02 (5)</p> <p>Flammability: EN 1021-1, EN 1021-2, DIN 4102 B2, NF P 92-503 M2, Önorm B 3825, Önorm A 3800-1 Q1</p> <p>Other: EN 71-3 safety of toys (migration of certain elements) PERMABLOK3® ISO 18184 - reduction of Coronavirus¹ presence by morethan 90% within one hour of contact ISO 21702 – reduction of Coronavirus¹ activity by 99,9%within 24 hours of exposure on the surface Superior antibacterial, stain resistant and antifungal protection</p> |
| XTREME XR | <p>Composition: 100 % recycled polyester, non metallic dyestuffs</p> <p>Weight: 310 g/m² ±5%</p> <p>Abrasion resistance: ≥100 000 Martindale cycles</p> <p>Pilling: EN ISO 12945-2 (5)</p> <p>Colour fastness to light : EN ISO 105-B02 (6)</p> <p>Colour fastness to rubbing: EN ISO 105-X12 (wet: 4/dry: 4)</p> <p>Flammability: EN 1021-1, EN 1021-2, S 5852 Crib 5, BS 7176 medium hazard, BS 476 Class 1, DIN 4102 B1, NF D 60-013</p> <p>Other: EU Ecolabel certificate, OEKO-TEX® STANDARD 100 certificate, Indoor Advantage™ certificate (Gold), Environmental Product Declaration - Synthetic fabric composition</p> |

¹ testing was conducted with material exposed to FelineCoronavirus (same coronavirusidae family, structures and mechanisms similar to SARS-Cov2) podobne do SARS-Cov2)

Upholstery materials

Technical specifications

3 PRICE GROUP

| | |
|-------------------------------------|--|
| CHILI CG | <p>Composition: 100 % post-consumer recycled polyester FR (FR inside the fiber)</p> <p>Weight: 335 g/m²</p> <p>Abrasion resistance: 60 000 Martindale cycles</p> <p>Pilling: EN ISO 12945-2 (4-5)</p> <p>Colour fastness to light: EN ISO 105-B02 (5-8)</p> <p>Colour fastness to rubbing: EN ISO 105-X12 (wet: 4-5 / dry: 4-5)</p> <p>Flammability: EN 1021-1, EN 1021-2, BS 5852 Crib 5, BS 7176 medium hazard, DIN 4102 B1, NF P 92-503-5 M1, NF D 60-013 AM18, EN 13501-1 B-s1, d0, Calif. Bull. 117</p> <p>Other: OEKO-TEX® STANDARD 100 certificate, EU Ecolabel certificate</p> |
| MOULIN-FR MU | <p>Composition: 77 % polypropylene, 10 % recycled polyester from bottles, 7 % modacrylic, 6 % recycled cotton</p> <p>Weight: 568 g/m² ± 5 %</p> <p>Abrasion resistance: 80 000 Martindale cycles</p> <p>Pilling: EN ISO 12945-2 (4-5)</p> <p>Colour fastness to light: EN ISO 105-B02 (min. 6)</p> <p>Colour fastness to rubbing: EN ISO 105-X12 (wet: 4-5 / dry: 4-5)</p> <p>Flammability: EN 1021-1, EN 1021-2, BS 7176 low hazard, Calif. Bull. 117</p> <p>Other: OEKO-TEX® STANDARD 100 certificate</p> |
| HARLEQUIN HQ | <p>Composition: 77% polyester, 23% post-consumer recycled polyester</p> <p>Weight: 318 g/m²</p> <p>Abrasion resistance: 100 000 Martindale cycles</p> <p>Pilling: EN ISO 12945-2 (5)</p> <p>Colour fastness to light : EN ISO 105-B02 (5-7)</p> <p>Colour fastness to rubbing: EN ISO 105-X12 (wet: 4-5 / dry: 4-5)</p> <p>Flammability: EN 1021-1, EN 1021-2 Calif. Bull. 117E</p> <p>Other: OEKO-TEX® STANDARD 100 certificate, EU Ecolabel certificate, Cradle to Cradle Certified® Bronze</p> |
| SILVERTEX SX | <p>Composition: upper layer: 100% PERMABLOK3® (vinyl / urethane) bottom layer: 100% Hi-Loft²™ polyester</p> <p>Weight: 685 g/m²</p> <p>Abrasion resistance: 300 000 Martindale cycles</p> <p>Flammability: EN 1021-1, EN 1021-2, DIN 4102 B2, NF P 92-503 M2, Önorm B 3825, Önorm A 3800-1 Q1</p> <p>Other: EN 71-3 - safety of toys (migration of certain elements) ISO 21702 - reduction of Coronavirus¹ activity by 99,9% within 24 hours of exposure on the surface PERMABLOK3® ISO 18184 - reduction of Coronavirus¹ presence by more than 90% within one hour of contact Superior antibacterial, stain resistant and antifungal protection</p> |
| STEP STG & STEP MELANGE STMG | <p>Composition: 100 % Trevira CS</p> <p>Weight: 335 g/m²</p> <p>Abrasion resistance: 100 000 Martindale cycles</p> <p>Pilling: EN ISO 12945-2 (min. 4-5)</p> <p>Colour fastness to light : EN ISO 105-B02 (min. 5-7)</p> <p>Colour fastness to rubbing: EN ISO 105-X12 (wet: 4-5/dry: 4-5)</p> <p>Flammability: EN 1021-1, EN 1021-2, BS 5852 Crib 5, BS 7176 medium hazard, DIN 4102 B1, NF P 92-503-5 M1, NF D 60-013 AM 18, Calif. Bull. 117EEU</p> <p>Other: Ecolabel certificate, OEKO-TEX® STANDARD 100 certificate</p> |

¹ testing was conducted with material exposed to Feline Coronavirus (same coronavirus family, structures and mechanisms similar to SARS-Cov2) podobne do SARS-Cov2)

4 PRICE GROUP

| | |
|----------------------|--|
| BLAZER CUZ | <p>Composition: 100 % cvirgin wool, non metallic dyestuffs</p> <p>Weight: 460 g/m²</p> <p>Abrasion resistance: ≥ 50 000 Martindale cycles</p> <p>Colour fastness to light : EN ISO 105-B02 (4-6)</p> <p>Colour fastness to rubbing: EN ISO 105-X12 (wet: 4/dry: 4)</p> <p>Flammability: EN 1021-1, EN 1021-2, BS 7176 low hazard, BS 476 Class 1, NF D 60-013 AM 18</p> <p>Other: EU Ecolabel certificate, Indoor Advantage™ certificate (Gold), Environmental Product Declaration - Natural fabric composition</p> |
| FOCUS ROYAL FC | <p>Composition: 100 % New Zealand wool</p> <p>Weight: 450 g/m²</p> <p>Abrasion resistance: 100 000 Martindale cycles</p> <p>Pilling: EN ISO 12945-2 (4-5)</p> <p>Colour fastness to light: EN ISO 105-B02 (5-8)</p> <p>Colour fastness to rubbing: EN ISO 105-X12 (wet: 4-5/dry: 4-5)</p> <p>Flammability: EN 1021-1, EN 1021-2, Calif. Bull. 117</p> <p>Other: OEKO-TEX® STANDARD 100 certificate, EU Ecolabel certificate</p> |
| OCEANIC OOC | <p>Composition: 100% post-consumer recycled polyester, including 50% SEAQUAL® yarn</p> <p>Weight: 497 g/m² ±5%</p> <p>Abrasion resistance: min. 100 000</p> <p>Pilling: EN ISO 12945-2 (4-5)</p> <p>Colour fastness to light: EN ISO 105-B02 (4-6)</p> <p>Flammability: EN 1021-1, EN 1021-2, BS 7176 low hazard</p> <p>Other: OEKO-TEX® STANDARD 100 certificate, EU Ecolabel certificate</p> |
| MAIN LINE FLAX MLF | <p>Composition: 75% cvirgin wool, 25% flax</p> <p>Weight: 437 g/m² ±5%</p> <p>Abrasion resistance: ≥50 000</p> <p>Colour fastness to light : EN ISO 105 - B02 (4-5)</p> <p>Flammability: EN 1021-1, EN 1021-2, BS 7176 medium hazard, ÖNORM B 3825 & A 3800-1 (58kg/m³ CMHR Foam), UNI 9175 Classe 1 IM, BS 5852 Crib 5, NF D 60-013 AM 18</p> <p>Other: EU Ecolabel certificate, Indoor Advantage™ certificate (Gold), Environmental Product Declaration - Natural fabric composition</p> |
| SKAI® PAROTEGA NF | <p>Composition: approx. 85% PVC-compound, approx. 15% CO-knitted fabric</p> <p>Weight: 780 g/m² ±50 g/m²</p> <p>Abrasion resistance: 300 000</p> <p>Colour fastness to light : 7DIN EN ISO 105-B02 (7)</p> <p>Flammability: EN1021-1, EN1021-2, BS 5852 Crib 5, DIN 4102 B1, DIN 4102 B2, DIN EN 13501-1 B, s3, d0, DIN 66084 P-a, NF P 92-503 M1, NF D 60-013 AM 18</p> |
| SYNERGY LDS | <p>Composition: 95 % virgin wool, 5 % polyamide</p> <p>Weight: 400 g/m² ±5%</p> <p>Abrasion resistance: ≥ 100 000 Martindale cycles</p> <p>Pilling: EN ISO 12945-2 (4)</p> <p>Colour fastness to light : EN ISO 105-B02 (5)</p> <p>Colour fastness to rubbing: EN ISO 105-X12 (wet: 4/dry: 4)</p> <p>Flammability: EN 1021-1, EN 1021-2, BS 7176 low hazard, NF D 60-013 AM18, Önorm B 3825 & Önorm A 3800-1 Q1 (58 kg/m³ CMHR Foam)</p> <p>Other: EU Ecolabel certificate, Indoor Advantage™ certificate (Gold), Environmental Product Declaration - Natural fabric composition</p> |

Upholstery materials

Technical specifications

5 PRICE GROUP

| | | |
|--------------|--|---|
| REMIX 3 RX | Composition: | 90 % new wool, 10 % nylon |
| | Weight: | 300 g/m ² |
| | Abrasion resistance: | 100 000 Martindale cycles |
| | Pilling: | EN ISO 12945-2 (4) |
| | Colour fastness to light : | EN ISO 105-B02 (6) |
| | Colour fastness to rubbing: | EN ISO 105-X12 (wet: 4 / dry: 4-5) |
| | Flammability: | EN 1021-1, EN 1021-2, BS 5852 ignition source 3 NF D 60-013 AM 18, Önorm B 3825 (B1), Önorm A 3800-1 (Q1), Calif. Bull. 117E |
| Other: | EU Ecolabel certificate, Greenguard certificate (Gold), Environmental Product Declaration (EPD) | |

6 PRICE GROUP

| | | |
|---------------------|-----------------------------|---|
| ARONA LEATHER AN | Composition: | Leather with high-quality mineral tanning, non-solvent PU-finishing |
| | Colour fastness to light : | EN ISO 105 - B02 (≥ 5) |
| | Colour fastness to rubbing: | EN ISO 11640 (wet: ≥ 4/dry: ≥ 4) |
| | Flammability: | EN 1021-1, EN 1021-2 |
| | Other: | Raw material: South-German and Austrian cattle hides |
| NAPPA LEATHER NAP | Composition: | 100% leather (1,0-1,2 mm) |
| | Colour fastness to light : | EN ISO 105 - B02 (≥ 5) |
| | Flammability: | EN 1021-1, EN 1021-2 |
| | Other: | Raw material: hides of Central European breeds. Environmentally friendly mineral tanning. |



