



KARL ANDERSSON & SÖNER
SINCE 1898

CIRKAPRISLISTA SEK EXKL MOMS & FRAKT
1 MARS 2026 - 28 FEBRUARI 2027

VERS.1



NEW PRODUCTS 2026



INNEHÅLL CONTENT

BORD TABLE

78 Bat
72 Bouquet
36 Brygga
47 Cap bord table
75 Cap podium
80 Eight
82 Hito
46 Kanecct
55 Locus Pelarbord/Pedestal table
57 Locus Bord/Table
76 Lollipop
73 Mandala *NEWS 2026!*
79 Mill
82 Newton
59 Opera Bord/Table
59 Opera Pulpstol *NEWS 2026!*
44 Peel
62 Pivå
37 Press
80 Puddle
41 Rollo
45 Study
66 Tailor
80 Terrane
74 Thinner
85 T.I.P. *NEWS 2026!*
81 Trayo
82 Trio
68 Trippo
51 Woodwork
53 Woodwork Light

FÖRVARING STORAGE

8 2K-skåp
17 Alva
14 Cavetto
18 Cubebrick
24 Front hylla shelf
6 KA72
17 Level
13 May
12 Mrs Bill
17 Part
11 Upper

EXPONERINGSSYSTEM DISPLAY

22 1KM Display
22 Arc
22 Collar
30 Front fristående free-standing
29 Front förvaring storage
24 Front hylla shelf
21 Front klädhängare coat hanger
23 Front list ledge
26 Front panel
24 Front plant
25 Front tavla board
17 Part
32 Ridå
33 Slope

RUMSAVDELARE ROOM DIVIDER

35 Ondulé Screen *NEWS 2026!*
34 Ray

KLÄDHÄNGARE COAT HANGER

20 Chess
21 Front
20 Knob
20 Nest
21 ponoq

SITTMÖBLER SEATING

86 Colo Chair
103 Facile
89 Hygge
105 Kamón
85 Kaz
96 Meander
84 Milo
98 Ondulé
100 Ondulé Club
95 Sander Bar
95 Sander Café
90 Sander Conference
93 Sander Chair
92 Sander Lounge
94 Sander Meeting
83 Shell Pall Stool
87 Shell Stol Chair
101 Soigné *NEWS 2026!*
66 Tailor bänk bench
88 Taverna
85 T.I.P. *NEWS 2026!*

PROVER SAMPLE

4 Prover Trä Laminat
Samples Wood Laminate
5 Tyg Läder Filt
Fabric Leather Felt

PRODUKTER 2026 PRODUCTS 2026

OPERA PULPET
Pall Stool
T.I.P.
Skärmvägg Floor Screen
ONDULÉ SCREEN
Fätöjlj Soffa Easy chair Sofa
SOIGNÉ
Soffbord Sofa table
MANDALA
Årets färg Color of the year
NCS S8010-Y90R mörkbrun
NCS S7010-Y90R mellanbrun
NCS S4020-Y60R ljusrosa

Karl Andersson & Söner Rosendalagatan 6, SE-56134 Huskvarna, Sweden. +46(0)36-13 25 30. info@karl-andersson.se. karl-andersson.se
Bankgiro 544-5408. Bank SHB 6641-710 660 758. VAT SE556043831801. IBAN SE50 6000 0000 0000 5509 6999. SWIFT HANDESS
F-skattebevis

FÖRSÄLJNINGSVILLKOR

Priser: Angivna priser är i SEK, exklusive mervärdesskatt.

Leveransvillkor: fritt fabrik inkl. standardemballage.

Frakt till återförsäljarens lager inom Sverige debiteras med följande %-sats baserat på nettovärde. Tillägg för telefonavisering och direktleverans till företag tillkommer med 120 SEK exkl. moms. Kostnad för tidslossnig tillkommer. Direktleverans till privatkund sker ej.

Inom Sverige gäller följande tariffer från Huskvarna:
Fraktavstånd upp till 500 km 7% minimum 680 SEK exkl.moms
Fraktavstånd upp till 501-1000 km 11% minimum 1180 SEK exkl.moms
Fraktavstånd över 1001 km 12% minimum 1580 SEK exkl.moms

Vikt och Volym är angett i netto d v s exkl. pall och emballage.
Lastpall kostnad per styck, netto exkl. moms: 120x80, 160x80cm 120SEK. 200x80, 240x80cm 280SEK. Pallkrage 90SEK

Transportskada: Vid mottagning av gods är alltid mottagaren ansvarig att avsyna godset både ut- och invändigt. Skada på emballaget ska noteras på fraktsedeln med kvittens från chauffören. Följ anvisningar på fraktsedeln. **Om anvisningar inte följs utgår ingen ersättning för transportskada.** Vid förlust eller saknad av kolli kontakta transportören.

Returer: Returer får ej ske utan vårt godkännande.

Betalning: 30 dagar netto från fakturadatum eller enligt överenskommelse. Sald vara är vår egendom tills full betalning är erlagd. Efter förfallodatum debiteras dröjsmålsränta med 1,5% per månad enligt uppgift på offer/orderbekräftelse/faktura.

Garanti: Garanti gäller mot fabriktions- och materialfel. Garantitiden på levererat gods är två år från fakturadatum. Åtgärder bedöms individuellt.

Administrationsavgift: Order under 1550 SEK brutto exkl. moms utgår en administrationsavgift på 60 SEK.

Övrigt: Vi förbehåller oss rätten till ändringar i kollektion, priser eller konstruktion. All information i denna prislista, inklusive måttuppgifter, material och priser kan bli ändrade utan föregående avisering.Tidigare prislister och försäljningsvillkor annulleras härmed.

Utförande: För varje artikel är standardutförande angivet i prislistan. Mått är i millimeter (mm). L=längd, B=bredd D=djup, H=höjd, ø=Diameter.

Fanér till bordsskivor: Standardfanér är 0,6mm Fanérläggning planskuret, utvikt. Omslip/lack max 1gång.
Tjockfanér ca 1,5mm mot tillägg 1230 SEK per kvadratmeter. Fanérläggning planklagt, utseende likt massivt trä. Omslip/lack 2-3gångar.

Ytbehandling: Ytbehandling är halvmatt syrahärdad lack. Deklarerade produkter enligt Möbelfakta är ytbehandling vattenbaserad lack. Avvikelse i utförande eller ytbehandling mot tillägg.

Standard färger: Lack (50) finns i följande standard färger svart (.58), gul(.62), röd(.67), grön(.74), mörkgrön (.76), snövit(.81), vit(.82), grå(.84), antracit(.86) uppge rätt färgnummer vid beställning se NCS-beteckningar på sid 4.

Special färger: Specialfärger enligt NCS kan erhållas mot ett tillägg av 2750 SEK per färg och order.

Standardbets: Standardbets är svart(.11), wenge(.12) snövit(.13), rödbrun(.14), grön(.15), röd(.16), blå(.17), brun(.18), grå(.19), antracit(.20), valnöt(.21), mörkgrön(.23) Betsning sker på ek eller ask om inget annat anges. Uppge rätt färgnummer vid beställning se NCS-beteckningar på sid 4.

Specialbets: Vissa produkter kan erhållas i bets enligt förfrågan. Betstillägg tillkommer med 15% + startkostnad 2750 SEK.

Vitpigment: .25 vitpigment på ask och .26 vitpigment på ek. Pristillägg lika som standardbets.

Läder: Standardläder se sidan 5. För klädsel i insänt läder tillkommer extra klädselkostnad enligt offert.

Tyg: Standard tyger i respektive prisgrupp på sid. 5. Vid tyger med mönsterpassning samt vid avtagbar klädsel ökar tygätgången. Fråga oss om detaljerade uppgifter per modell. För insänt tyg är kostnad 790 SEK.

Skötselråd: Läs om hur du vårda din möbel på karl-andersson.se | OM KA | SKÖTSELRÅD | VÅRDA DIN MÖBEL

Trä: Trä är ett levande naturmaterial och har därför varierande teckningar och olika utseende. Detta är ett kvalitetsbegrepp och ej föremål för reklamationer.

Möbelfakta

Produkter som innehar möbelfakta är: Cap, Collar, Colo Chair, Facile, Front list, Front panel, Front fristående, Hygge, Kamón Dinner, Kanecct, Kaz, Locus, Meander, Milo, Ondulé, Ondulé Club, Opera, Peel, Pivá, Press med träben höjd 725mm, Ridá, Ray, Rollo, Sander - Bar, Café, Chair, Conference, Lounge, Meeting, Shell pall, Shell stol, Tailor, Taverna, Woodwork, Woodwork Light. Dessa produkter är ytbehandlade med vattenbaserad lack. Om syrahärdad lack önskas ska detta framgå på order.

CONDITIONS OF SALE

Prices: The prices are in SEK. Taxes, etc are not included.

Delivery: Ex Works incl. standard packaging.

Freight to the retailer's warehouse is paid by Karl Andersson & Söner AB and debited at a nominal rate of the invoiced value of the goods supplied. VAT will be added. Surcharge for telephone notification of delivery charged by 120 SEK. Cost of appointment of deliver is added. Direct deliveries to private consumer will only be on reseller's freight agreement.

Weight and volume are stated as net, i.e. excluding pallet and packaging.
Pallet per each, net excl. VAT: 120x80, 160x80cm 120SEK. 200x80, 240x80cm 280SEK. Pallet collar 90SEK.

Transport damage: When receiving packages, the recipient is always responsible to check the packages' condition, outside and inside. Damages of the package have to be noted on the consignment note with a signature from the driver. Follow the instructions on the consignment note. **If you do not follow the instruction on the consignment, no payment for damages will be paid.** If a package is lost or missing, contact the freight forwarder.

Returns: Return may not be made without our prior approval.

Payment: Prepayment unless otherwise agreed. Goods sold remain the property of Karl Andersson & Söner AB until full payment has been received. After the due date for payment, unsettled accounts will be charged with penalty interest in accordance with the terms stated on the order confirmation/invoice. Payment methods are IBAN and SWIFT (no checks or credit cards accepted).

Limited Warranty: Goods are guaranteed against manufacturing faults and material defects for a period of two years from the date of invoice. The measures taken to rectify the situation will be decided on a case-to-case basis.

Administration Fee: For orders less than SEK 1550 gross, excl. VAT, an administration fee of SEK 60 will be charged.

Other terms: We reserve the right to make changes to the range, to prices and to designs. All the information provided, including measurements, material and prices are approximate and can be subject to change without prior notice. This notice supersedes all earlier pricelists and conditions of sale.

Finishes: The pricelist shows the standard finish for each article. Dimension in millimeter (mm). L=length, B=width, D=depth, H=height, ø=Diameter.

Veneer for tabletops:Standard veneer is 0.6 mm. Veneering: flat-cut veneer, book-matched/opened. Re-sanding/re-lacquering max. 1 time. Thick veneer approx. 1.5 mm at an additional cost of SEK 1230 per square meter. Veneering: plank-laid, appearance similar to solid wood. Re-sanding/re-lacquering 2–3 times.

Surface treatment: The standard surface finish is acid-hardened, semi-matt plastic lacquer. Products that holds Möbelfakta have waterbased treatment. Other finishes or surface treatment are available at a supplement.

Standard colors: Lacquer (50) is available in standard colors of black(.58), yellow(.62), red(.67), green(.74), darkgreen(.23) snow white(81), white(.82), anthcite(.86), gray(.84). Please state the correct color code when ordering. NCS-code see page 4.

Special colors: Special colors are available for a surcharge of SEK 2750 per color/per order.

Standard stains: Standardstain is black(.11), wenge(.12), snow white(.13.), red brown(.14), green(.15), red(.16), blue(.17), brown(.18), gray(.18), anthracite(.20), valnöt (.21), darkgreen(.23). Stain is on oak or ash if nothing else says. Please state the correct color code when ordering. NCS-code see page 4.

Special stains: Certain products may be supplied in a stained finish on request. In such instances a surcharge is made equivalent to 15% of the order value + a start-up cost of SEK 2750.

White glaze: .26 white pigment on ash and .25 white pigment on oak. Extra cost same as standard stain.

Leather: Standard leather see page 5. Customers may also request a quotation for the cost of covering furniture in leather provided by the customer.

Fabrics: See the fabrics in the various price groups on page 5 For removable fabric and for pattern fitting, extra fabric is required. Contact us for detailed information. Cost for covering furniture with the customer's own fabric SEK 790. Make order of fabric samples directly from the producer.

Furniture Care: Read about how to take of your furniture at karl-andersson.se | ABOUT KA | FURNITURE CARE | TAKING CARE OF YOUR FURNITURE

Wood: Wood is a living material with natural variations in hue and grain pattern. Any slight differences in appearance are an indication of genuine quality and do not form the basis of a cause for complaint.

Products that holds **Möbelfakta** are Cap, Collar, Colo Chair, Facile, Front ledge, Front panel, Front free-standing, Hygge, Kamón Dinner, Kanecct, Kaz, Locus, Meander, Milo, Ondulé, Ondulé Club, Opera, Peel, Pivá, Press wooden legs height 725mm, Ray, Ridá, Rollo, Sander - Bar, Café, Chair, Conference, Lounge, Meeting, Shell stool, Shell chair, Tailor, Taverna, Woodwork, Woodwork Light. These products are standard surface waterbased. In case you want acid-hardened, semi-matt plastic lacquer please note on order.

PROVER SAMPLES

Alla produkter finns ej i alla olika utförande. För mer information se under respektive produkt.
Tänk även på att de tryckta proverna kan skilja sig i färg, struktur och nyans jämfört med levererad produkt.

All products are not available in all different versions. For more information please see under actual product.
Also keep in mind that the printed samples can differ in color, texture and shades compared with delivered product.

TRÄSLAG WOOD

Ytbehandling är klarlack i glansvärde 18, halvmatt. Alternativa ytbehandlingar olja, olja + lack kan erbjudas.
Treated with clear lacquer in a no. 18 semi-matt finish. Other available finishes are oil or oil + lacquer.



.10 Ek Oak .20 Björk Birch .30 Ask Ash

STANDARDFÄRGER STANDARD COLORS

Glansvärde 35, halvblank. Alternativa färger kan erbjudas enligt NCS-skalan.
Semi-gloss no. 35. Other colors are available in accordance with the NCS color system.



.62 Gul Yellow NCS S0580-Y .67 Röd Red NCS 2070-Y80R .74 Grön Green NCS S2010-G40Y .76 Mörkgrön Darkgreen NCS S8010-G30Y .81 Snövit Snow white NCS S0500-N .82 Vit White NCS 0702-Y04R



.84 Grå Gray NCS S2500-N .86 Antracit Anthracite NCS S7502-B .58 Svart Black NCS S9000-N

STANDARDBETSER STANDARD STAINS

Bets på ask eller ek om inget annat anges. Topplack är klarlack i glansvärde 18, halvmatt. Specialbetsar enligt insänt prov kan erbjudas.
Stain on ash or oak if not otherwise specified. Top coat of clear lacquer in a no. 18 semi-matt finish. Special stains in accordance with samples sent to us are also available.



.11 Svart bets Black stain NCS S9000-N .12 Wenge bets stain .13 Snövit bets Snow white stain .14 Rödbrun bets Red-brown stain .15 Grön bets Green stain NCS S2010-G40Y .23 Mörkgrön Dark green stain NCS S8010-G30Y

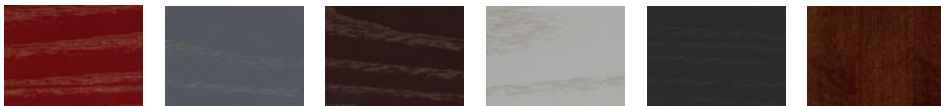

.16 Röd bets Red stain NCS S4050-Y80R .17 Blå bets Blue stain NCS S5010-R90B .18 Brun bets Brown stain NCS S8005-Y80R .19 Grå bets Gray stain NCS S2500-N .20 Antracit bets Anthracite stain NCS S7502-B .21 Valnöt bets Walnut stain

VITPIGMENT WHITE GLAZE

Vitpigment på ek eller ask om inget annat anges. Topplack är klarlack i glansvärde 18, halvmatt.
White glaze on oak or ash if not otherwise specified. Top coat of clear lacquer in a no. 18 semi-matt finish.



.25 Vitpigment ask White glaze ash .26 Vitpigment ek White glaze oak

LAMINAT LAMINATE



.60 Vit White NCS S0502-G50Y .61 Svart Black Fenix NTM 0720 Nero Ingo NCS S8500-N .71 Ek Oak F5374 NAT .72 Björk Birch F7555 MAT .73 Ask Ash F8843 NAT

DESKTOP

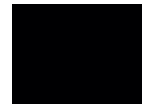

.90 Svart Black Forbo Nero col. 4023 NCS S9000-N

FILT FELT

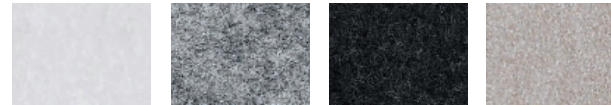

Offwhite
Press, Slope

Ljusgrå Light grey
Ondulé, Ondulé Club, Ondulé Screen, Press, Ridå, Slope

Antracit Anthracite
Ondulé, Ondulé Club, Ondulé Screen, Press, Ridå, Slope

Beige
Ondulé, Ondulé Club, Ondulé Screen

Fanér till bordsskivor

Standardfanér är 0,6mm Fanérläggning planskuret, utvikt. Omslip/lack max 1gång.
Tjockfanér ca 1,5mm mot tillägg. Fanérläggning planklagt, utseende likt massivt trä. Omslip/lack 2-3gångar.

Veneer for tabletops

Standard veneer is 0.6 mm. Veneering flat-cut veneer, book-matched/opened. Re-sanding/re-lacquering max.1 time.
Thick veneer approx. 1.5 mm at an additional cost. Veneering plank-laid, appearance similar to solid wood.
Re-sanding/re-lacquering 2-3 times.

TYGER LÄDER FABRIC LEATHER

Tyger, Fabric				Läder, Leather
Prisgrupp 1 Pricegroup	Prisgrupp 2 Pricegroup	Prisgrupp 3 Pricegroup	Prisgrupp 4 Pricegroup	Elmo Soft (EL)
Acton (VE)	Amaze Loop (GA)	Breeze Fusion (GA)	Barnum (NE)	99999 svart black
Arrow* (VE)	Ame (KV)	Canvas 2 (KV)	Memory 2 (KV)	93068 brun brown
Autumn (KV)	Auckland (VE)	Fiord 2 (KV)	Moss (KV)	22030 natur natural
Avon (VE)	Blues CS II (NE)	Focus Royal (GA)	Nobel (GA)	33004 cognac
Cliint (VE)	Bowen (VE)	Hallingdal 65 (KV)	Safire (KV)	
Colour Connect (VE)	Capture (GA)	Hero Heather (KV)	TwillWool (GA)	
Creek* (VE)	Coco (NE)	Intro CS (NE)	Umber (GA)	
Easy (SV)	Coral (VE)	Morph (GA)	Umi (GA)	
Guest (KV) Harper (SV)	Cyber (GA)	Naveli (KV)		
Harper (SV)	Diade (KV)	Remix 3 (KV)		
Illusion 3.0 konstläder*	Dikson (VE)	Re-wool 2 (KV)		
Illusion 3.0 full grain* (NE)	Europost 2 (GA)	Steelcut Trio 3 (KV)		
Jazz CS (NE)	Focus (GA)	Technicolour (KV)		
Jemo* (VE)	Focus Melange (GA)	Tonus 4 (KV)		
Kahki (SV)	Foster (VE)			
Leone* (VE)	Fuga (VE)			
Liberty (NE)	Grain (GA)			
Lido/Lido Trend (NE)	Hestan (VE)			
Lido+ (NE)	Mood (GA)			
Lillehammer (NE)	Moore (VE)			
Malta* (VE)	Parcel Loop (GA)			
Margrethe (NE)	Passion (GA)			
Pod CS (NE)	Pop CS (NE)			
Puxx1&2* (BrJ)	Poppy (SV)			
Semi (SV)	Rami (SV)			
Slottsfjord (NE)	Sport (KV)			
Step Melange (GA)	Studio CS (NE)			
Surf (NE)				
TelaMia (KV)				
Tone (SV)				
Wooly (NE)				
Zenith (VE)				

Fabrikat/Supplier
BrJ=Bröderna Jörgensen
GA=Gabriel

KV=Kvadrat
NE=Nevotex

SV=Ludvig Svensson
VE=Vescom

EL=Elmo leather
*=artificial leather



Bord Table WOODWORK LIGHT | Stol Chair SANDER CHAIR | Sofa Sofa FACILE | Hylla Shelf LEVEL | CAP PODIUM



Bord Table OPERA | Barstol Bar Stool SANDER BAR

KA72 Göran Malmvall 1972

Skåp är av fanerad trälamell i ek, björk, ask, standardfärger, standardbets på ask och vitpigment på ek och ask. Beslag är förnicklade eller i mässing. Sockel inkluderad med ställfötter (gäller ej bensockel artno BS73). Skåpen levereras ihopsatta. Ska skåp placeras fristående med synlig trärygg måste en ryggpanel beställas. Till skåpen finns olika tillbehör. Ange vid beställning: Beslag förnicklade eller mässing. Skåp B400 ange vänster eller högerhängd dörr, framifrån sett.

The cabinets are made of veneered blockboard in oak, birch, ash, standard colors, standard stains on ash and white glazed oak and ash. The fittings are nickel-plated or made of brass. Cabinets are supplied ready assembled with adjustable screws in the plinth (not for high base artno BS73). If the intention is to place the cabinet away from a wall, it is necessary to order a back panel to cover the back of the cabinet. There are various accessories for the cabinets. Specify when ordering: Fittings nickel-plated or brass. Cabinet B400 enter left or right hung door, seen from the front.



Artno

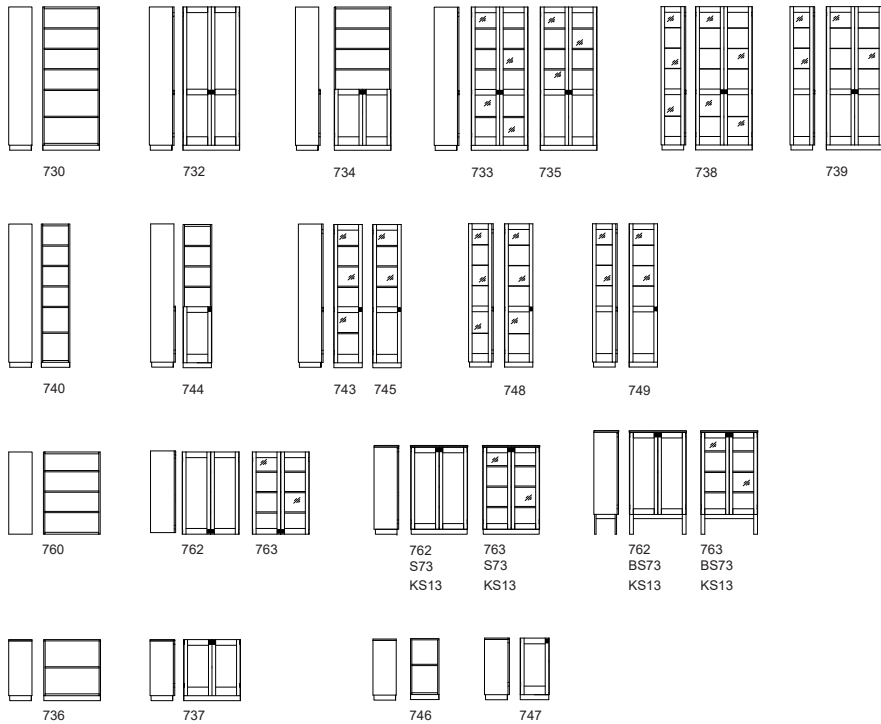

Tillbehör
Accessories

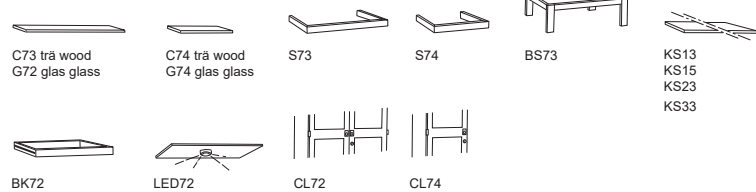

Tillbehör Accessories Artno	Bredd Width mm	Djup Depth mm	Höjd Height mm	KA72 SEK	Extra SEK	Vikt netto Weight net kilos	
				.10 ek oak .20 björk birch .30 ask ash .50 lack color	Standardbets på ask Standard stain on ash Vitpigment ek ask White glazed oak ash		
C73	Trähylplan till bredd 800mm Wooden shelf. to width 800mm	760	320	1460	+230	3	
G72	Glashyllplan till bredd 800mm Glass shelf to width 800mm	760	320	1460 glas glass		3	
C74	Trähylplan till bredd 400mm Wooden shelf. to width 400mm	360	320	1070	+170	2	
G74	Glashyllplan till bredd 400mm Glass shelf to width 400mm	360	320	1070 glas glass		2	
S73	Sockel till bredd 800mm Low base to width 800mm	800	305	70	1190	+190	2
S74	Sockel till bredd 400mm Low base to width 400mm	400	305	70	1190	+190	2
BS73	Bensockel till bredd 800mm High base to width 800mm	800	305	280	4820	+730	2
KS13	Krönskiva Top panel	810	355	20	2710	+420	3
KS15	Krönskiva Top panel	1210	355	20	3360	+500	7
KS23	Krönskiva Top panel	1610	355	20	4850	+730	7
KS33	Krönskiva Top panel	2410	355	20	7340	+1100	10
BK72	Back med glidlister till bredd 800, placeras bakom dörr. Träslag bok Tray with supports to width 800 placed behind doors. Wood beech	725	330	70	2910		2
LED72.2	LED belysning. Varmvitt ljus 2700K 24V inkl. 2m anslutningskabel. Förnicklade LED. Warm white light 2700K, 24V incl. 2m connection cable. Nickelplated				2310		
CL72	Cylinderlås monterat i dubbdörr. Förnicklade Lock placed in double doors Nickelplated				1190		
CL74	Cylinderlås monterat i enkeldörr. Förnicklade. Lock placed in single door. Nickel- plated.				1020		

Artno	Välj beslag: förnicklat eller mässing. *Vid skåp B400 ange vänster eller högerhängd dörr, framifrån sett. *Choice of fittings: nickelplated or brass. *Cabinet W400 state when ordering right or left door, seen from the front.	Bredd Width mm	Djup Depth mm	Höjd Height mm	KA72 SEK		Extra SEK	Vikt netto Weight net kilos	Volym Volume Net
					.10 ek oak .20 björk birch .30 ask ash	.50 Lack Color	Standardbets på ask Standard stain on ash Vitpigment ek ask White glazed oak ash		
730	Bokhylla Öppen. 1 fast + 4 flyttbara trähyllor. Bookcase. 1 fixed + 4 adjustable wooden shelves.	800	330	2020	19550	15640	+2940	39	0,8
732	Skåp. Trädörrar nedtill och upptill. 1 fast + 4 flyttbara trähyllor. Cabinet. Wooden doors below and above. 1 fixed + 4 adjustable wooden shelves.	800	350	2020	35880	31840	+5390	60	0,8
734	Skåp. Trädörrar nedtill och öppen hylla upptill. 1 fast + 4 flyttbara trähyllor. Cabinet. Wooden door below and open shelf above. 1 fixed + 4 adjustable wooden shelves.	800	350	2020	28420	24690	+4250	49	0,8
733	Skåp. Glasörrar. 1 fast + 4 flyttbara trähyllor. Cabinet. Glass doors. 1 fixed + 4 adjustable wooden shelves.	800	350	2020	33030	28270	+4950	64	0,8
735	Skåp. Trädörrar nedtill och glas upptill. 1 fast + 4 flyttbara trähyllor. Cabinet. Wooden doors below and glass above. 1 fixed + 4 adjustable wooden shelves.	800	350	2020	33690	30000	+5050	62	0,8
738	Skåp. Örrar och sidor med glas. 5 flyttbara glashyllor. Cabinet. Doors and sides with glass. 5 adjustable glass shelves.	800	350	2020	37600	34900	+5650	65	0,8
739	Skåp. Örrar och sidor med trä nedtill och glas upptill. 1 fast + 1 flyttbara trähyllor och 3 flyttbara glashyllor Cabinet. Doors and sides with wood below and glass above. 1 fixed + 1 adjustable wooden shelves and 3 adjustable glass shelves.	800	350	2020	38490	35670	+5780	59	0,8
736	Bokhylla. Öppen. 1 flyttbar trähylla Bookcase. Open. 1 adjustable shelf.	800	330	865	11290	8560	+1680	20	0,4
737	Skåp. Örrar med trä. 1 flyttbar trähylla. Bookcase. Doors with wood. 1 adjustable shelf	800	350	865	20220	17460	+3030	24	0,4
760	Bokhylla. Öppen. 3 flyttbara trähyllor, exkl. sockel och krönskiva. Bookcase. Open. 3 adjustable wooden shelves, excl. base and top plate.	800	330	1155	13820	11020	+2080	20	0,46
762	Skåp. Trädörrar, 3 flyttbara trähyllor, exkl. sockel och krönskiva. Cabinet. Wooden doors. 3 adjustable wooden shelves, excl. base and top plate.	800	350	1155	24900	21750	+3710	36	0,46
762,S73,KS13	Skåp. Trädörrar, 3 flyttbara trähyllor inkl. sockel och krönskiva Cabinet. Wooden doors. 3 adjustable wooden shelves incl. base and top plate.	800	350	1245	29080	25670	+4370	46	0,46
762,BS73,KS13	Skåp. Trädörrar, 3 flyttbara trähyllor inkl. bensockel och krönskiva Cabinet. Wooden doors. 3 adjustable wooden shelves incl. high base and top plate.	800	350	1445	32440	29290	+4860	50	0,57
763	Skåp. Glasörrar. 3 flyttbara trähyllor, exkl. sockel och krönskiva. Cabinet. Glass doors. 3 adjustable wooden shelves, excl. base and top plate.	800	350	1155	23820	20790	+3580	46	0,46
763,S73,KS13	Skåp. Glasörrar. 3 flyttbara trähyllor inkl. sockel och krönskiva Cabinet. Glass doors. 3 adjustable wooden shelves incl. base and top plate.	800	350	1245	27730	24680	+4140	46	0,46
763,BS73,KS13	Skåp. Glasörrar. 3 flyttbara trähyllor inkl. bensockel och krönskiva Cabinet. Glass doors. 3 adjustable wooden shelves incl. high base and top plate.	800	350	1445	31350	28320	+4700	50	0,57
740	Bokhylla Öppen. 1 fast + 4 flyttbara trähyllor. Bookcase. 1 fixed + 4 adjustable wooden shelves.	400	330	2020	16060	13170	+2410	30	0,42
744*	Skåp. Trädörrar nedtill och öppen hylla upptill. 1 fast + 4 flyttbara trähyllor. Cabinet. Wooden door below and open shelf above. 1 fixed + 4 adjustable wooden shelves.	400	350	2020	20440	17590	+3060	41	0,42
743*	Skåp. Glasörrar. 1 fast + 4 flyttbara trähyllor. Cabinet. Glass doors. 1 fixed + 4 adjustable wooden shelves.	400	350	2020	22800	19960	+3420	41	0,42
745*	Skåp. Trädörrar nedtill och glas upptill. 1 fast + 4 flyttbara trähyllor. Cabinet. Wooden doors below and glass above. 1 fixed + 4 adjustable wooden shelves.	400	350	2020	23220	20130	+3480	41	0,42
748*	Skåp. Örrar och sidor med glas. 5 flyttbara glashyllor. Cabinet. Doors and sides with glass. 5 adjustable glass shelves.	400	350	2020	26570	24190	+3990	41	0,42
749*	Skåp. Örrar och sidor med trä nedtill och glas upptill. 1 fast + 1 flyttbara trähyllor och 3 flyttbara glashyllor Cabinet. Doors and sides with wood below and glass above. 1 fixed + 1 adjustable wooden shelves and 3 adjustable glass shelves.	400	350	2020	27290	24880	+4090	41	0,42
746	Bokhylla. Öppen. 1 flyttbar trähylla Bookcase. Open. 1 adjustable shelf.	400	330	865	9630	7560	+1450	14	0,17
747*	Skåp. Örrar med trä. 1 flyttbar trähylla. Bookcase. Doors with wood. 1 adjustable shelf.	400	350	865	14090	11800	+2110	19	0,17

2K SKÅP Tony Almén Peter Gest 2000

Skåp är av trälamell med faner i ek, björk, standardfärger, standardbets på ek och vitpigmenterad ek. Benen är i mattkromad stål inkl. justerbara ställfötter och handtagen i rostfritt mattborstat stål. Ska skåp placeras fristående med synlig trärygg måste en ryggpanel beställas. Skåp är ihopsatta vid leverans. Skåp i bredd 450mm ange vänster eller högerhängd dörr, framifrån sett. Till skåpen finns olika tillbehör enligt nedan.

The cabinets are made of blockboard finished in oak, birch veneer, standard color and standard stains on oak. The legs are made of matt chromed steel and the handles from stainless, matt brushed steel. If the intention is to place the cabinet away from a wall, it is necessary to order a back panel to cover the back of the cabinet. Cabinets are supplied ready assembled with adjustable screws in the leg to ensure they stand straight and steady. Cabinet in width 450mm enter left or right hung door, seen from the front. There are various accessories for the cabinets as below.

Artno

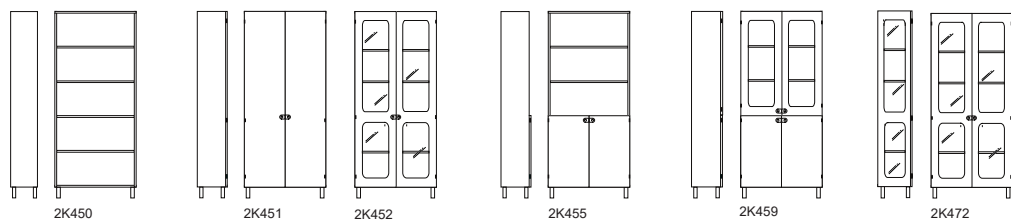
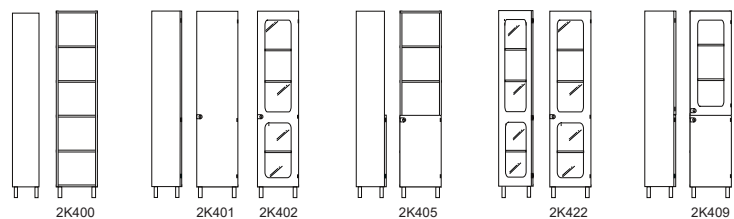
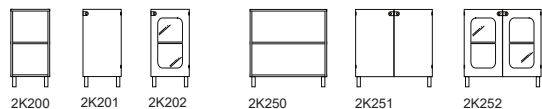
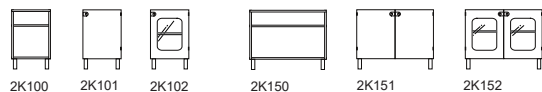

Tillbehör
Accessories

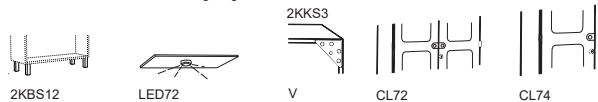

2K-skåp SEK Extra SEK

Tillbehör Accessories Artno		Bredd Width mm	Djup Depth mm	Höjd Height mm	.10 ek oak .20 björk birch .50 lack color	Standardbets på ek Standard stain on oak Vitpigment ek White glazed oak	Vikt netto Weight net kilos
2KC150	Trähyllplan till bredd 900mm Wooden shelf to width 900mm	860	330		1510	+230	3
2KG150	Glashyllplan till bredd 900mm Glass shelf to width 900mm	860	330		1510 glas glass		3
2KC100	Trähyllplan till bredd 450mm Wooden shelf. to width 450mm	410	330		1090	+180	2
2KG100	Glashyllplan till bredd 450mm Glass shelf to width 450mm	410	330		1090 glas glass		2
2KKS1	Krönskiva Top panel	910	365	20	2650	+400	3 / 0,02cbm
2KKS2	Krönskiva Top panel	1810	365	20	5300	+800	6 / 0,05cbm
2KKS3	Krönskiva Top panel	2715	365	20	7970	+1190	9 / 0,07cbm
2KBS12.90	Ben i metall, adjustable Legs in metal adjustable			120	1440		3
LED72.2	LED belysning. Varmvitt ljus 2700K 24V inkl. 2m anslutningskabel. Förnicklad LED. Warm white light 2700K, 24V incl. 2m connection cable. Nickelplated				2310		
V	Väggbeslag 4st monterade. Endast för låga skåp. Wall bracket. 4pcs mounted. Only for low cabinet.				1440		
CL72.2	Cylinderlås monterat i dubbeldörr. Förnicklad Lock placed in double doors Nickelplated				1190		
CL74.2	Cylinderlås monterat i enkeldörr. Förnicklad. Lock placed in single door. Nickel- plated.				1020		

Artno	*Vid skåp B450 ange vänster eller högerhängd dörr, framifrån sett. *Cabinet W450 state when ordering right or left door, seen from the front.	Bredd Width mm	Djup Depth mm	Höjd Height mm	2K-skåp SEK		Extra SEK	Vikt netto Weight net kilos	Volym Volume net
					.10 ek oak .20 björk birch	.50 Lack Color	Standardbets på ek Standard stain on oak Vitpigment ek White glazed oak		
2K100	Bokhylla Öppen. 1 flyttbara trähylla. Bookcase. 1 adjustable wooden shelf.	450	340	696	9190	7220	+1370	18	0,15
2K101*	Skåp. Slät trädörr. 1 flyttbar trähylla. Cabinet. Plain door. 1 adjustable wooden shelf.	450	360	696	11880	10920	+1790	20	0,15
2K102*	Skåp. Glasdörr. 1 flyttbar trähylla. Cabinet. Glass door. 1 adjustable wooden shelf.	450	360	696	13190	11160	+1980	20	0,15
2K150	Bokhylla Öppen. 1 flyttbara trähylla. Bookcase. 1 adjustable wooden shelf.	900	340	696	10640	8040	+1590	22	0,32
2K151	Skåp. Släta trädörrar. 1 flyttbar trähylla. Cabinet. Plain doors. 1 adjustable wooden shelf.	900	360	696	16160	13510	+2420	30	0,32
2K152	Skåp. Glasdörrar. 1 flyttbar trähylla. Cabinet. Glass doors. 1 adjustable wooden shelf.	900	360	696	18650	15940	+2800	30	0,32
2K200	Bokhylla Öppen. 1 flyttbara trähylla. Bookcase. 1 adjustable wooden shelf.	450	340	910	9900	7760	+1500	22	0,21
2K201*	Skåp. Slät trädörr. 1 flyttbar trähylla. Cabinet. Plain door. 1 adjustable wooden shelf.	450	360	910	12880	10720	+1930	25	0,21
2K202*	Skåp. Glasdörr. 1 flyttbar trähylla. Cabinet. Glass door. 1 adjustable wooden shelf.	450	360	910	14520	12430	+2170	25	0,21
2K250	Bokhylla Öppen. 1 flyttbara trähylla. Bookcase. 1 adjustable wooden shelf.	900	340	910	11340	8590	+1700	38	0,4
2K251	Skåp. Släta trädörrar. 1 flyttbar trähylla. Cabinet. Plain doors. 1 adjustable wooden shelf.	900	360	910	17450	14630	+2630	44	0,4
2K252	Skåp. Glasdörrar. 1 flyttbar trähylla. Cabinet. Glass doors. 1 adjustable wooden shelf.	900	360	910	20790	17890	+3120	44	0,4
2K300	Bokhylla Öppen. 2 flyttbara trähyllor. Bookcase. 2 adjustable wooden shelves.	450	340	1272	11860	9390	+1780	24	0,3
2K301*	Skåp. Slät trädörr. 2 flyttbara trähyllor. Cabinet. Plain door. 2 adjustable wooden shelves.	450	360	1272	15200	12700	+2280	28	0,3
2K302*	Skåp. Glasdörr. 2 flyttbara trähyllor. Cabinet. Glass door. 2 adjustable wooden shelves.	450	360	1272	17220	14820	+2590	28	0,3
2K350	Bokhylla Öppen. 2 flyttbara trähyllor. Bookcase. 2 adjustable wooden shelves.	900	340	1272	13980	11150	+2100	50	0,54
2K351	Skåp. Slät trädörrar. 2 flyttbara trähyllor. Cabinet. Plain doors. 2 adjustable wooden shelves.	900	360	1272	20710	17830	+3090	54	0,58
2K352	Skåp. Glasdörrar. 2 flyttbara trähyllor. Cabinet. Glass door. 2 adjustable wooden shelves.	900	360	1272	24650	21850	+3690	54	0,58
2K400	Bokhylla Öppen. 1 fast + 3 flyttbara trähyllor. Bookcase. 1 fixed + 3 adjustable wooden shelves.	450	340	2062	15530	12500	+2320	30	0,5
2K401*	Skåp. Slät trädörr. 1 fast + 3 flyttbara trähyllor. Cabinet. Plain wooden door. 1 fixed + 3 adjustable wooden shelves.	450	360	2062	19860	16890	+2980	33	0,5
2K402*	Skåp. Glasdörr. 1 fast + 3 flyttbara trähyllor. Cabinet. Glass door. 1 fixed + 3 adjustable wooden shelves.	450	360	2062	23770	20790	+3580	42	0,5
2K405*	Skåp. Slät trädörr nedtill. 1 fast + 3 flyttbara trähyllor. Cabinet. Plain wooden door below. 1 fixed + 3 adjustable wooden shelves.	450	360	2062	18540	15590	+2790	31	0,5
2K409*	Skåp. Slät trädörr nedtill och glas upptill. 1 fast + 3 flyttbara trähyllor. Cabinet. Plain wooden door below and glass above. 1 fixed + 3 adjustable wooden shelves.	450	360	2062	23910	20860	+3590	42	0,5
2K422*	Skåp. Dörrar och sidor i glas. 4 flyttbara glashyllor. Cabinet. Doors and sides in glass. 4 adjustable glass shelves.	450	360	2062	30770	27350	+4630	42	0,5

Artno	*Vid skåp B400 ange vänster eller högerhängd dörr, framifrån sett. *Cabinet W400 state when ordering right or left door, seen from the front.	Bredd Width mm	Djup Depth mm	Höjd Height mm	2K-skåp SEK		Extra SEK		
					.10 ek oak .20 björk birch	.50 Lack Color	Standardbets på ek Standard stain on oak	Vikt netto Weight net kilos	Volym Volume net
2K450	Bokhylla Öppen. 1 fast + 3 flyttbara trähyllor. Bookcase Open. 1 fixed + 3 adjustable wooden shelves.	900	340	2062	18550	14520	+2790	50	0,9
2K451	Skåp. Slåta trädörrar. 1 fast + 3 flyttbara trähyllor. Cabinet. Plain wooden doors. 1 fixed + 3 adjustable wooden shelves.	900	360	2062	27350	23320	+4100	80	0,9
2K452	Skåp. Glasdörrar. 1 fast + 3 flyttbara trähyllor. Cabinet. Glass doors. 1 fixed + 3 adjustable wooden shelves.	900	360	2062	35050	30970	+5240	69	0,9
2K455	Skåp. Slåta trädörr nedtill. 1 fast + 3 flyttbara trähyllor. Cabinet. Plain wooden doors below. 1 fixed + 3 adjustable wooden shelves.	900	360	2062	24650	20700	+3690	56	0,9
2K459	Skåp. Slåt trädörr nedtill och glas upptill. 1 fast + 3 flyttbara trähyllor. Cabinet. Plain wooden door below and glass above. 1 fixed + 3 adjustable wooden shelves.	900	360	2062	35380	31350	+5300	80	0,9
2K472	Skåp. Dörrar och sidor i glas. 4 flyttbara glashyllor. Cabinet. Doors and sides in glass. 4 adjustable glass shelves.	900	360	2062	40240	36140	+6040	72	0,9

UPPER Anton Björnsing 2019

Skåp. Upper har fin baksida vilket gör det lämpligt att använda som rumsavdelare. Dörrarna når ovanför själva skåpet och används som handtag. Skåp är fanerad MDF i utförande ek, ask, standardfärger, standardbetsar på ask, vitpigmenterad ek och ask. Benstativ är försedda med justerbara ställfötter. Som tillval finns låsbara hjul, lås, krönskivor i olika utförande. Skåpet levereras monterat.

Cabinet. Upper has an attractively finished rear panel makes the cabinet ideal as a room divider. The doors, which project above the cabinet itself, can be used as handles. The cabinet is made of veneered MDF, finished in oak, ash, standard colors, standard stains on ash or white-glazed oak or ash. Optional extras: locking wheels and top panels in white glass, cork, stainless steel, oak, ash, standard colours or standard stains. The leg frame has adjustable feet. The cabinet is delivered assembled.

Artno

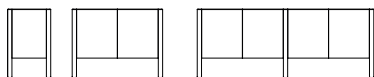

UP151

UP181

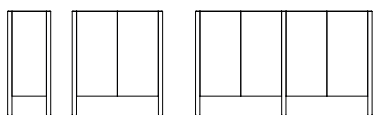

UP251

UP281

Tillbehör
Accessories

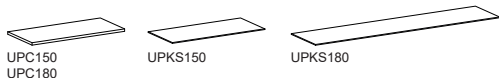

UPC150
UPC180

UPKS150

UPKS180



UPH4
UPH6

CL72

Artno	Bredd Width mm	Djup Depth mm	Höjd Height mm	Upper SEK		Extra SEK	Vikt netto Weight net kilos	Volym Volume net	
				.10 ek oak .30 ask ash	.50 Lack Color	Standardbets på ask Standard stain on ash Vitpigment ek, ask White glazed oak, ash			
UP151	840	400	635	18900	15100	+2830	24	0,28	
UP181	1640	400	635	28580	23090	+4270	42	1,36	
UP251	1 flyttbart hyllplan. 1 adjustable shelf.	840	400	970	22760	18090	+3420	38	0,41
UP281	2 flyttbara hyllplan. 2 adjustable shelves.	1640	400	970	35450	27910	+5320	70	1,92
Tillbehör/Accessories									
UPC150	Trähyllplan till Wooden shelf to UP151, UP251	807	367	19	1300	840	+200	2	
UPC180	Trähyllplan till Wooden shelf to UP181, UP281	795	367	19	1300	840	+200	3	
UPKS150	Krönskiva Top panel	806	366	6	1460	1460	+220	3	
UPKS180	Krönskiva Top panel	1606	366	6	1960	1960	+290	5	
UPKS150.60	Krönskiva vit laminat Top panel white laminate	806	366	6	1460			3	
UPKS150.90	Krönskiva rostfri. Top panel stainless steel	806	366	6	1800			3	
UPKS150.91	Krönskiva vitt glas. Top panel white glass	806	366	6	1800			3	
UPKS150.92	Krönskiva Top panel cork	806	366	6	1070			1	
UPKS180.60	Krönskiva vit laminat Top panel white laminate	1606	366	6	1960			5	
UPKS180.90	Krönskiva rostfri. Top panel stainless steel	1606	366	6	2910			5	
UPKS180.91	Krönskiva vitt glas. Top panel white glass	1606	366	6	2910			5	
UPKS180.92	Krönskiva Top panel cork	1606	366	6	1400			2	
UPH4	Låsbara hjul, 4st. Svarta. Skåp med hjul lika höjd som skåp med ben. Lockable castors, 4pcs. Black. Cabinet incl. castors same height as cabinet.				1780				
UPH6	Låsbara hjul, 6st. Svarta. Skåp med hjul lika höjd som skåp med ben. Lockable castors, 6pcs. Black. Cabinet incl. castors same height as cabinet.				2510				
CL72	Lås förnicklat. Om lås ska sättas i båda dörrparen till UP181, UP281, glöm inte att beställa dubbelt antal lås. Lock nickelplated. If locks are to be inserted in both pair of doors artno UP181, UP281. Do not forget to order the double number of locks.				1150				

MRS BILL Mick Born 2009

Skåp. Tillverkas i trälamell med faner av ek, björk, standardfärger, standardbets på ek samt vitpigmenterad ek. Ska skåpen placeras fristående med synlig rygg måste ryggpanel beställas. Skåp B450 ange vänster eller högerhängd dörr, framifrån sett. Skåpen levereras ihopsatta med ställfot i sockeln.

The cabinet itself is a blockboard construction, veneered in oak, birch, standard colors, standard stains on oak or white glazed oak. If the intention is to place the cabinet away from a wall, it is necessary to order a back panel to cover the back of the cabinet. Cabinet W450 enter left or right hung door, seen from the front. Cabinets are supplied ready assembled with adjustable screws in the plinth to ensure they stand straight and steady.

Artno

Skåp Cabinet

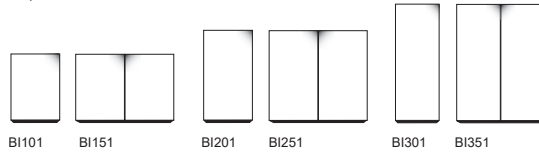

BI101 BI151 BI201 BI251 BI301 BI351

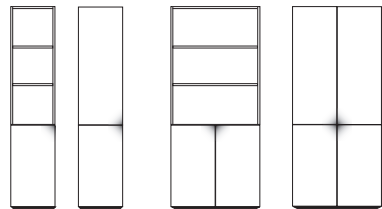

BI405 BI408 BI455 BI458

Tillbehör
Accessories

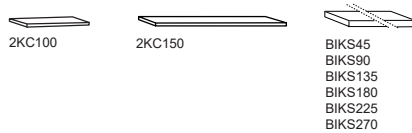

V CL72 CL74

Artno	*Vid skåp B450 ange vänster eller högerhängd dörr, framifrån sett. *Cabinet W450 state when ordering right or left door, seen from the front.	Bredd Width mm	Djup Depth mm	Höjd Height mm	Mrs Bill SEK		Extra SEK		
					.10 ek oak .20 björk birch	.50 Lack Color	Standardbets på ek Standard stain on oak	Vitpigmenterad ek White glazed oak	Vikt netto Weight net kilos
BI101*	Skåp. Slät trädörr. 1 flyttbar trähylla inkl. krönskiva BIKS45. Cabinet. Plain door. 1 adjustable wooden shelf incl. top panel BIKS45.	450	360	621	12970	10720	+1940	18	0,15
BI151	Skåp. Släta trädörrar. 1 flyttbar trähylla inkl. krönskiva BIKS90. Cabinet. Plain doors. 1 adjustable wooden shelf incl. top panel BIKS90	900	360	621	18470	15420	+2790	30	0,28
BI201*	Skåp. Slät trädörr. 1 flyttbar trähylla inkl. krönskiva BIKS45. Cabinet. Plain door. 1 adjustable wooden shelf incl. top panel BIKS45.	450	360	835	13950	11500	+2100	22	0,2
BI251	Skåp. Släta trädörrar. 1 flyttbar trähylla inkl. krönskiva BIKS90. Cabinet. Plain doors. 1 adjustable wooden shelf incl. top panel BIKS90	900	360	835	19820	16310	+2980	40	0,38
BI301*	Skåp. Slät trädörr. 2 flyttbara trähyllor inkl. krönskiva BIKS45. Cabinet. Plain door. 2 adjustable wooden shelves incl. top panel BIKS45.	450	360	1197	16540	13590	+2490	30	0,33
BI351	Skåp. Släta trädörrar. 2 flyttbara trähyllor inkl. krönskiva BIKS90. Cabinet. Plain doors. 2 adjustable wooden shelves incl. top panel BIKS90	900	360	1197	23840	19990	+3580	50	0,56
BI405*	Skåp. Slät trädörr nedtill. 1 fast + 3 flyttbara trähyllor. Skåp. Plain door below. 1 fixed + 3 adjustable wooden shelves.	450	360	1967	18000	14850	+2690	33	0,40
BI408*	Skåp. Släta trädörrar. 1 fast + 3 flyttbara trähyllor. Cabinet. Plain doors. 1 fixed + 3 adjustable wooden shelves.	450	360	1967	21960	18400	+3290	35	0,40
BI455	Skåp. Slät trädörr nedtill. 1 fast + 3 flyttbara trähyllor. Skåp. Plain door below. 1 fixed + 3 adjustable wooden shelves.	900	360	1967	24090	19710	+3620	56	0,80
BI458	Skåp. Släta trädörrar. 1 fast + 3 flyttbara trähyllor. Cabinet. Plain doors. 1 fixed + 3 adjustable wooden shelves.	900	360	1967	34610	29080	+5190	60	0,80
Tillbehör Accessories									
2KC150	Trähyllplan till bredd 900mm Wooden shelf to width 900mm	860	330		1510	1510	+230	3	
2KC100	Trähyllplan till bredd 450mm Wooden shelf to width 450mm	410	330		1090	1090	+180	2	
BIKS45	Krönskiva Top panel	450	340	40	1300	1140	+200	6	
BIKS90	Krönskiva Top panel	900	340	40	2650	2350	+400	9	
BIKS135	Krönskiva Top panel	1350	340	40	4000	3440	+590	12	
BIKS180	Krönskiva Top panel	1800	340	40	5300	4580	+800	16	
BIKS225	Krönskiva Top panel	2250	340	40	6650	5740	+1000	20	
BIKS270	Krönskiva Top panel	2700	340	40	7970	6920	+1190	25	
V	Väggbeslag 4st monterade. Endast för låga skåp. Wall bracket. 4pcs mounted. Only for low cabinet.				1440				
CL72	Cylinderlås monterat i dubbeldörr. Förnicklad Lock placed in double doors. Nickelplated				1190				
CL74	Cylinderlås monterat i enkeldörr. Förnicklad Lock placed in single doors. Nickelplated				1020				

Byrå. Lådorna är gjorda i björkplywood och har delutdrag, dämpad stängning och dold expander. May tillverkas i MDF med faner av ek, ask, standardfärger, standardbetser samt vitpigmenterad ek och ask. Välj mellan massiva träben med ställfot, fyra låsbara hjul eller blankkromad stålmed. Hjulens färg är samma som stommens, men vid val av stomme i ask eller ek är hjulen alltid vita. Byrån levereras monterad.

Chest of drawers. The drawers are made of birch plywood and have partial extension drawer slides, dampened closure and hidden expanders. May is made of MDF and is available in oak and ash veneers, standard colors, standard stains on ash and white glazed oak or ash. Choose from solid wooden legs with adjustment screws, steel runners with a polished chrome finish or four lockable castors. The color of the castors matches the chest of drawers, except for the ash or oak versions, on which the castors are always white. May is delivered assembled.

Artno

Träfot inkl. ställfot. Solid wooden legs incl. adjustment screws.

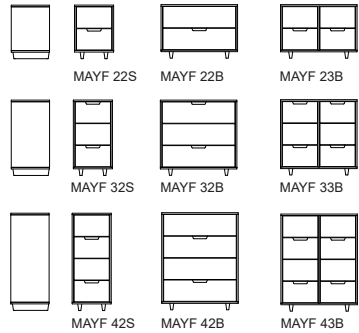

Låsbara hjul. Lockable castors.

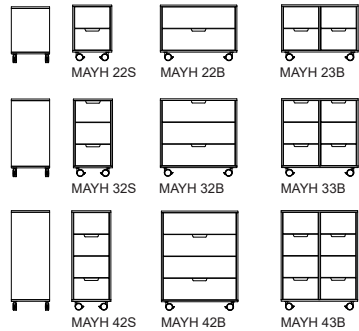

Stålmed blank krom. Steel runners polished chrome.

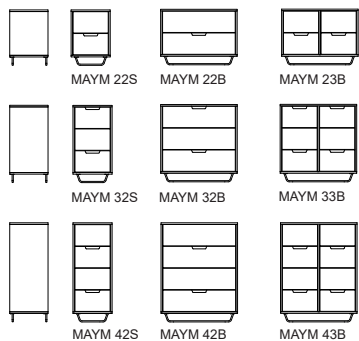

May SEK

Extra SEK

Artno	Bredd Width mm	Djup Depth mm	Höjd Height mm	May SEK		Extra SEK		
				.10 ek oak .30 ask ash	.50 Lack Color	Standardbets på ask Standard stain on ash	Vikt netto Weight net kilos	Volym Volume net
Träfot Solid wooden legs								
MAYF 22S	460	450	628	11100	7650	+1660	33	0,2
MAYF 32S	460	450	885	14030	9380	+2110	44	0,28
MAYF 42S	460	450	1141	16740	11060	+2510	52	0,34
MAYF 22B	900	450	628	12380	8860	+1860	40	0,33
MAYF 32B	900	450	885	15420	11030	+2310	66	0,5
MAYF 42B	900	450	1141	18540	13160	+2790	70	0,65
MAYF 23B	900	450	628	17510	11600	+2630	45	0,33
MAYF 33B	900	450	885	23170	15060	+3470	77	0,5
MAYF 43B	900	450	1141	28710	18500	+4310	95	0,64
Låsbara hjul Lockable castors								
MAYH 22S	460	450	656	11100	7650	+1660	33	0,2
MAYH 32S	460	450	912	14030	9380	+2110	44	0,28
MAYH 42S	460	450	1169	16740	11060	+2510	52	0,34
MAYH 22B	900	450	656	12380	8860	+1860	40	0,33
MAYH 32B	900	450	912	15420	11030	+2310	66	0,5
MAYH 42B	900	450	1169	18540	13160	+2790	70	0,65
MAYH 23B	900	450	656	17510	11600	+2630	45	0,33
MAYH 33B	900	450	912	23170	15060	+3470	77	0,5
MAYH 43B	900	450	1169	28710	18500	+4310	95	0,64
Stålmed Steel runners								
MAYM 22S	460	450	656	12010	8590	+1800	33	0,2
MAYM 32S	460	450	912	14970	10300	+2240	44	0,28
MAYM 42S	460	450	1169	17660	11980	+2650	52	0,34
MAYM 22B	900	450	656	13310	9790	+1990	40	0,33
MAYM 32B	900	450	912	16310	11950	+2440	66	0,5
MAYM 42B	900	450	1169	19470	14090	+2920	70	0,65
MAYM 23B	900	450	656	18460	12500	+2780	45	0,33
MAYM 33B	900	450	912	24070	16010	+3620	77	0,5
MAYM 43B	900	450	1169	29630	19410	+4440	95	0,64

CAVETTO kaschkasch 2016

Cavetto en byggbar hyllserie med oändliga variationer. Det finurliga med hyllserien är att kanterna på hyllplanen är utformade som en skåra så att man enkelt kan montera rygg och sidor mellan hyllplanen utan beslag. Cavetto kan sättas mot vägg, användas som avdelare i ett rum eller bygga ett rum i rummet. Hyllan kan användas från ett eller två håll beroende på hur man fyller hyllan med de olika tillbehören. Hyllan finns som fristående och byggsektioner.

Cavetto består av massiva runda träben med ställskruvar som sätts ihop med lamellhyllplan. Tillbehören är mellan- och yttersidor, rygg, låda med helutdrag och dörrar (endast till bredd 900mm). Backar i tre olika höjder som sätts över hyllplanen utan rygg alternativt staplas på varandra. Träslag är ek, ask, standardbetser på ask och vitpigmenterad ek eller ask. Tillbehören finns även i standardfärger. Större enheter av Cavetto levereras delmonterad och monteras ihop med enkla verktyg.

Cavetto, a shelf series that can be configured in endless variations. The ingenious thing about Cavetto is that the edges of the shelves are shaped so that back and side panels can be inserted between them without the need for any fittings. Cavetto can be placed against a wall, positioned as a room divider or used to build a room within a room. It can be accessed from one or two directions depending on how the shelves are filled with the different accessories.

Cavetto is made of round solid wood legs with adjustable feet that are linked by blockboard shelves. Cavetto can then be filled with accessories, mid sides, outer sides, backs, a fully removable drawer and pair of doors (only for width 900 mm). Crates in three different heights can be placed above the shelf or stacked on top of each other. Choose from oak, ash, standard stains on ash, white glazed oak or ash and standard colors (only for accessories). Cavetto is supplied partially assembled and can be fully assembled with simple tools

Fristående Free standing

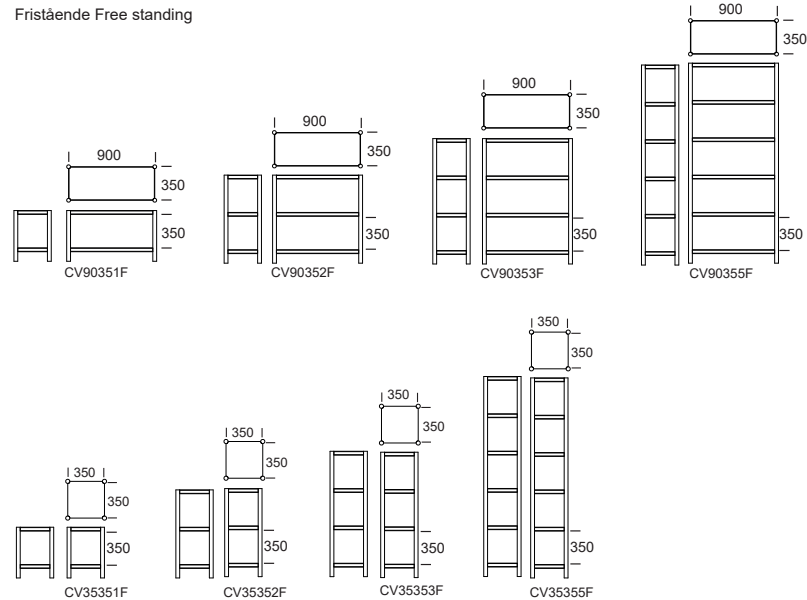

Byggsektioner / Add-on sections

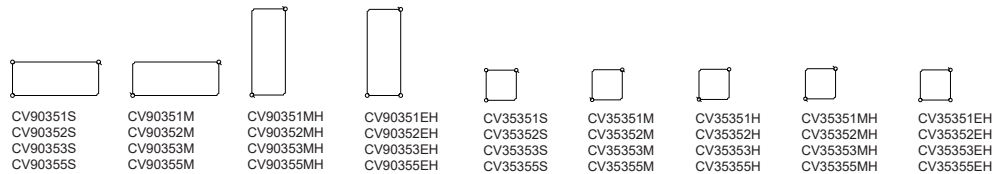

Tillbehör Accessories

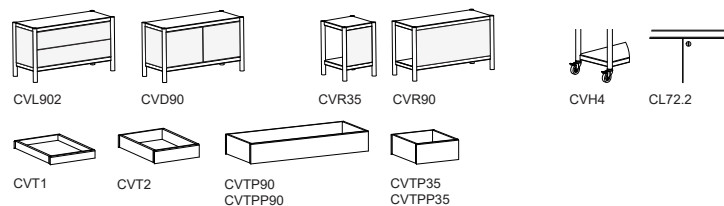

Tillbehör Accessories Artno		Cavetto SEK		Extra SEK	
		.10 ek oak .30 ask ash	.50 lack color	Standardbets på ask Standard stain on ask	Vikt netto Weight net kilos
CVL902	2 lådor med fullt utdrag inkl. sidor och rygg. 2 drawers incl. full extension incl. sides and back.	7540	6220	+1130	17
CVD90	2 dörrar inkl. sidor och rygg. 2 doors incl. sides and back.	5280	3730	+800	10
CVR35	Rygg eller sida. Back or side	660	550	+80	1
CVR90	Rygg.Back.	990	660	+160	3
CVT1	Back. Create. Ytermått/Outside: H40 W250 D350mm Inner: H28 W226 D326mm	1470	1470	+230	0,5
CVT2	Back. Create. Ytermått/Outside: H64 W250 D350mm Inner: H52 W226 D326mm	1580	1580	+240	0,8
CVTP90	Back. Create. Ytermått/Outside: H132 W858 D350mm Inner: H120	2870	2870	+430	1,5
CVTP35	Back. Create. Ytermått/Outside: H132 W308 D350mm Inner: H120	2150	2150	+330	2
CVPP90	Insats svart plåtåda för plantering till CVTP90 Inner black metal box for flowers to CVTP90	2100			1,5
CVPP35	Insats svart plåtåda för plantering till CVTP35 Inner black metal box for flowers to CVTP35	1960			1
CVH4	Låsbara hjul. Svart. H100 ø75mm. Pris avser 4st hjul. Totalhöjd ändras med +20mm Lockable castors. Black. H100 ø75mm. Price for 4pcs. castors. Total height changed +20mm.	1780			
CL72.2	Lås förnicklad. Endast till dubbeldörr. Lock nickelplated. Only for double doors.	1190			

Artno		Bredd Width mm	Djup Depth mm	Höjd Height mm	Cavetto SEK		Extra SEK		Vikt netto Weight net kilos	Volym Volume net
					.10 ek oak .30 ask ash	Standardbets på ask Standard stain on ash Vitpigment ek ask White glazed oak ash Ben Legs	Standardbets på ask Standard stain on ash Vitpigment ek ask White glazed oak ash Hyllplan shelves			
Fristående Free standing										
CV90351F		940	390	530	8600	+310	+500	22	0,25	
CV90352F		940	390	920	12100	+380	+750	38	0,42	
CV90353F		940	390	1310	15660	+470	+990	38	0,6	
CV90355F		940	390	2090	22570	+640	+1470	54	0,95	
CV35351F		390	390	530	7040	+310	+360	10	0,1	
CV35352F		390	390	920	9780	+380	+520	16	0,2	
CV35353F		390	390	1310	12590	+470	+700	20	0,26	
CV35355F		390	390	2090	17650	+640	+1040	28	0,41	
Byggsektion Add-on section										
CV90351S	Start End section	920	390	530	8110	+310	+500	22	0,25	
CV90352S	Start End section	920	390	920	11520	+380	+750	38	0,42	
CV90353S	Start End section	920	390	1310	14960	+470	+990	38	0,6	
CV90355S	Start End section	920	390	2090	21330	+640	+1470	54	0,95	
CV90351M	Mellan Middle section	900	390	530	7640	+310	+500	22	0,25	
CV90352M	Mellan Middle section	900	390	920	10940	+380	+750	38	0,42	
CV90353M	Mellan Middle section	900	390	1310	14250	+470	+990	38	0,6	
CV90355M	Mellan Middle section	900	390	2090	20390	+640	+1470	54	0,95	
CV90351MH	Mellan efter hörnsektion Middle after corner section	900	390	530	7640	+310	+500	22	0,25	
CV90352MH	Mellan efter hörnsektion Middle after corner section	900	390	920	10940	+380	+750	38	0,42	
CV90353MH	Mellan efter hörnsektion Middle after corner section	900	390	1310	14250	+470	+990	38	0,6	
CV90355MH	Mellan efter hörnsektion Middle after corner section	900	390	2090	20390	+640	+1470	54	0,95	
CV90351EH	End efter hörnsektion End after corner section	920	390	530	8110	+310	+500	22	0,25	
CV90352EH	End efter hörnsektion End after corner section	920	390	920	11520	+380	+750	38	0,42	
CV90353EH	End efter hörnsektion End after corner section	920	390	1310	14960	+470	+990	38	0,6	
CV90355EH	End efter hörnsektion End after corner section	920	390	2090	21330	+640	+1470	54	0,95	
CV35351S	Start End section	370	390	530	6520	+310	+360	10	0,1	
CV35352S	Start End section	370	390	920	9190	+380	+520	16	0,2	
CV35353S	Start End section	370	390	1310	11870	+470	+700	20	0,26	
CV35355S	Start End section	370	390	2090	16680	+640	+1040	28	0,41	
CV35351M	Mellan Middle section	350	390	530	6050	+310	+360	10	0,1	
CV35352M	Mellan Middle section	350	390	920	8630	+380	+520	16	0,2	
CV35353M	Mellan Middle section	350	390	1310	11150	+470	+700	20	0,26	
CV35355M	Mellan Middle section	350	390	2090	15710	+640	+1040	28	0,41	

Artno		Bredd Width mm	Djup Depth mm	Höjd Height mm	Cavetto SEK		Extra SEK		Vikt netto Weight net kilos	Volym Volume net
					.10 ek oak .30 ask ash	Standardbets på ask Standard stain on ash Vitpigment ek ask White glazed oak ash	Standardbets på ask Standard stain on ash Vitpigment ek ask White glazed oak ash	Hyllplan shelves		
Byggsektion Add-on section										
CV35351H	Hörn Corner section	350	390	530	6050	+310	+360	10	0,1	
CV35352H	Hörn Corner section	350	390	920	8630	+380	+520	16	0,2	
CV35353H	Hörn Corner section	350	390	1310	11150	+470	+700	20	0,26	
CV35355H	Hörn Corner section	350	390	2090	15710	+640	+1040	28	0,41	
CV35351MH	Mellan efter hörnsektion Middle after corner section	350	390	530	6050	+310	+360	10	0,1	
CV35352MH	Mellan efter hörnsektion Middle after corner section	350	390	920	8630	+380	+520	16	0,2	
CV35353MH	Mellan efter hörnsektion Middle after corner section	350	390	1310	11150	+470	+700	20	0,26	
CV35355MH	Mellan efter hörnsektion Middle after corner section	350	390	2090	15710	+640	+1040	28	0,41	
CV35351EH	End efter hörnsektion End after corner section	370	390	530	6520	+310	+360	10	0,1	
CV35352EH	End efter hörnsektion End after corner section	370	390	920	9190	+380	+520	16	0,2	
CV35353EH	End efter hörnsektion End after corner section	370	390	1310	11870	+470	+700	20	0,26	
CV35355EH	End efter hörnsektion End after corner section	370	390	2090	16680	+640	+1040	28	0,41	

Förslag Suggestions



CV90352S (2pcs), CVL902 drawer, CVD door, CVT2 create (3pcs), H920 W1840 D390



CV90351S (2pcs), CVD90 door (2pcs), H530 W1840 D390



CV90353S, CV35353H, CV90353EH
CVL902 drawer, CVD door, CVR90 back (2pcs)
CVR35 side/back (6pcs), CVT1 create (2pcs),
CVT2 create (1pc)
H1310 B1290 D390



CV90353F (2pcs)
H1310 W940 D390



CV90355S, CV95355M, CV90355S,
CVD90 door, CVL902 drawer, CVR90 back (2pcs),
CVR35 side/back (6pcs), CVT1 create (3pcs),
CVT2 create (4pcs),
H2090 W2190 D390

ALVA Rainer Mutsch 2020

Utgående produkt med reservation för slutförsäljning.

Alva kombinerar skira massiva trälister som spänns med fanerad hyllplanen i MDF, till en vacker och samtidigt stark konstruktion. Designen spänner materialet till sin gräns genom vridformågan hos träet som skapar den höga styvheten. Träslag är ek, ask, standardbets på ask och vitpigmenterad ek eller ask. Eller en kombination där trälistor kan betsas i standardbets på ask och hyllplanen i ek eller ask. I botten finns ställfötter. Hyllan levereras monterad. Hyllplanen och trälisterna är separerbara.

Outbound product with reservation for end of stock.

Alva shelving comprises slender strips of wood held securely in place by the shelves they suspend to create a construction that is as strong and stable as it is stunning to behold. The design takes the material to its limits by utilising the torsional strength of wood to create a structure of high rigidity. Alva is light and airy in appearance, but it is extremely sturdy too. The wood is oak or ash, finished with standard stains on ash, or white glaze on oak and ash. Alternatively, you can combine finishes and choose wooden frames in a standard stain on ash and shelves in oak or ash. The shelving is supplied assembled, with adjustment screws on the base. Shelves and wooden frames are detachable

Artno



AV523

Artno	Bredd Width mm	Djup Depth mm	Höjd Height mm	Diam mm	Alva SEK	Extra SEK	Vikt netto Weight net kilos	Volym Volume net
					.10 ek oak .30 ask ash	Standardbets på ask Standardstain on ash Vitpigmenterad ek, ask White glazed oak, ash		
AV523			1230	520	14390	+2230	28	0,45

LEVEL Lina Nordqvist 2012

Bokhylla som består av ett antal oregelbundet placerade rundstavar som bär upp flera hyllplan i olika nivåer. Inspirationen är hämtad bland annat från byggnadsställningen samt arkitekturen och konstruktionen i ett våningshus. Varje hyllplan är individuellt höjdanpassat för exempelvis pocketböcker, inbundna böcker alternativt tidningsmagasin som kan placeras mellan rundstavarna. Utförande är standardfärger och standardbets på ask. Hyllan levereras hopsatta med ställfötter under benen.

Level is the bookshelf that consists of a number of irregularly spaced rods that support several shelves at different heights. Inspiration from builders' scaffolding and the distinctive appearance of apartment block architecture. The distance between the shelves is adapted to the different sizes of paperbacks, hardback books and magazines that can be placed between the rods. It is finished in standard colors and standard stains on ash. The bookshelf is supplied ready assembled with adjustable screws in the legs to ensure they stand straight and steady.

Artno

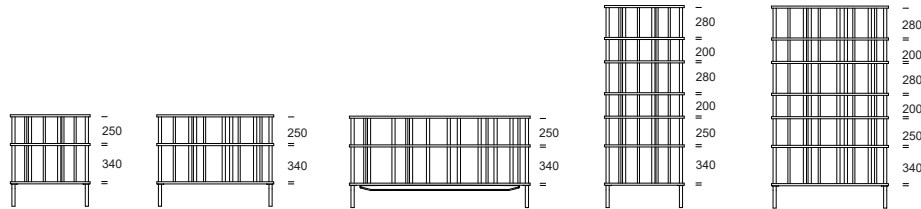

LE752

LE1102

LE1702

LE756

LE1106

Artno	Bredd Width mm	Djup Depth mm	Höjd Height mm	Level SEK		Vikt netto Weight net kilos	Volym Volume net
				.30 Standardbets på ask Standard stain on ash	.50 Lack Color		
LE752	750	320	860	10250	8960	20	0,3
LE1102	1100	320	860	12500	10960	25	0,4
LE1702	1700	320	860	18100	16190	44	0,66
LE756	750	320	1900	23140	20950	43	0,64
LE1106	1100	320	1900	28930	25800	60	0,9

PART PetterssonRudberg 2019

Utgående produkt med reservation för slutförsäljning.

Hyllan skapades under en geometrisk skisslek. Vänster- och högerhylla. Den tillverkas i massivträ i ek, ask och standardbets på ask, vitpigmenterad ek eller ask. Hyllan i standardfärg tillverkas i MDF. Hyllan skruvas upp på vägg.

Outbound product with reservation for end of stock.

Part shelf owes its origins to an exercise in geometric sketching. The shelf is available as a right- and left-hand unit. It is available in solid oak or ash, in standard stains on ash and in white-glazed oak or ash. The shelf in standard colours is made of MDF. Part is anchored to the wall with screws.

Artno

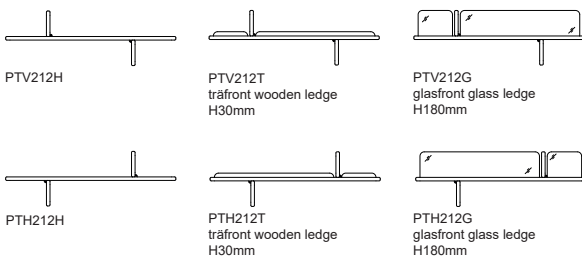

PTV212H

PTV212T
träfront wooden ledge
H30mm

PTV212G
glasfront glass ledge
H180mm

PTH212H

PTH212T
träfront wooden ledge
H30mm

PTH212G
glasfront glass ledge
H180mm

Artno	Bredd Width mm	Djup/Innerdjup Depth/Internal mm	Höjd Height mm	Part SEK		Extra SEK	Vikt netto Weight net kilos	Volym Volume net
				.10 ek oak .30 ask ash	.50 Lack Color	Standardbets på ask Standard stain on ash Vitpigmenterad ek, ask White glazed oak ash		
PTV212H	1200	120	385	4070	3930	+600	6	0,08
PTV212T	1200	120/100	385	6040	5870	+600	6	0,08
PTV212G	1200	120/100	385	6510	6360	+600	7	0,08
PTH212H	1200	120	385	4070	3930	+600	6	0,08
PTH212T	1200	120/100	385	6040	5870	+600	6	0,08
PTH212G	1200	120/100	385	6510	6360	+600	7	0,08

CUBE BRICK Roger Persson 2018

Utgående produkt med reservation för slutförsäljning.

Hyllan hängs på vägg med upphängningsbeslag i rostfri stål. Som standard ingår ett trähyllplan men kan bytas ut mot glashyllplan som placeras nedtill. Dessutom finns en mängd tillval så som trärygg, trä- eller glashyllplan som placeras upptill, trähyllplan med dimbar LED-belysning, glassidor och glassdörrar. Träslag är massiv ask, standardbetsar på ask och vitpigmenterad ask. Andra utförande efter förfrågan. Maxbelastning är 10kg per modul.

Outbound product with reservation for end of stock.

The shelf is hung on the wall with the help of the special suspension fitting in stainless steel supplied. A wooden shelf is included as standard, but customers also have the option of choosing a glass shelf. In addition there is, of course, a generous selection of accessories: wooden back, wooden or glass top panel, dimmable LED lighting, glass sides and glass doors. Cubebrick comes in solid ash, standard stains on ash and white glazed. Other options after requests. The maximum load per module is 10 kilos.

Artno



CB252

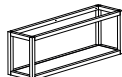

CB272



CB334

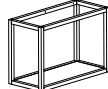

CB354

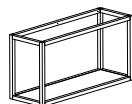

CB374

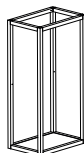

CB734

Artno		Bredd Width mm	Djup/Innerdjup Depth/Internal mm	Höjd Height mm	Cubebrick SEK		Tillbehör Accessories	Vikt netto Weight net kilos	Volym Volume net
					.30 ask ash	Standardbets på ask Standard stain on ash Vitpigmenterad ask White glazed ash			
CB252	Hylla inkl. trähyllplan placerad nedtill Shelf incl. wooden shelf placed below	540	180/140	240	4280	+750		3	0,03
CBTH52	Trähyllplan ask Wooden shelf ash						+550		
CBH52	Glashyllplan Glas shelf						+550		
CBTHB52	LED inkl. trähyllplan ask LED incl. wooden shelf ash						+1750		
CBTR25	Trärygg ask Wooden back ash						+640		
CB272	Hylla inkl. trähyllplan placerad nedtill Shelf incl. wooden shelf placed below	720	180/140	240	4510	+800		3	0,04
CBTH72	Trähyllplan ask Wooden shelf ash						+640		
CBGH72	Glashyllplan Glas shelf						+640		
CBTHB72	LED inkl. trähyllplan ask LED incl. wooden shelf ash						+1910		
CBTR72	Trärygg ask Wooden back ash						+840		
CB334	Hylla inkl. trähyllplan placerad nedtill Shelf incl. wooden shelf placed below	360	240/200	360	4220	+740		3	0,04
CBTH34	Trähyllplan ask Wooden shelf ash						+550		
CBGH34	Glashyllplan Glas shelf						+550		
CBTHB34	LED inkl. trähyllplan ask LED incl. wooden shelf ash						+1650		
CBTR33	Trärygg ask Wooden back ash						+600		
CBGS34	Glassidor Sides of glass						+1010		
CBGD33	Glasdörr enkel Door of glass single						+1500		
CB354	Hylla inkl. trähyllplan placerad nedtill Shelf incl. wooden shelf placed below	540	240/200	360	4420	+790		3	0,06
CBTH54	Trähyllplan ask Wooden shelf ash						+630		
CBGH54	Glashyllplan Glas shelf						+630		
CBTHB54	LED inkl. trähyllplan ask LED incl. wooden shelf ash						+1860		
CBTR35	Trärygg ask Wooden back ash						+710		
CBGS34	Glassidor Sides of glass						+1010		
CBGD35	Glasdörr dubbel Door of glass double doors						+3080		
CB374	Hylla inkl. trähyllplan placerad nedtill Shelf incl. wooden shelf placed below	720	240/200	360	4670	+820		4	0,08
CBTH74	Trähyllplan ask Wooden shelf ash						+700		
CBGH74	Glashyllplan Glas shelf						+700		
CBTHB74	LED inkl. trähyllplan ask LED incl. wooden shelf ash						+1980		
CBTR37	Trärygg ask Wooden back ash						+840		
CBGS34	Glassidor Sides of glass						+1010		
CBGD37	Glasdörr dubbel Door of glass double doors						+3420		

CUBE BRICK Roger Persson 2018

Artno		Bredd Width mm	Djup/Innerdjup Depth/Internal mm	Höjd Height mm	Cubebrick SEK		Vikt netto Weight net kilos	Volym Volume net
					.30 ask ash	Extra SEK		
CB734	Hylla inkl. trähyllplan placerad nedtill Shelf incl. wooden shelf placed below	360	240/200	720	4470	+800	4	0,08
CBTH34	Trähyllplan ask Wooden shelf ash						+550	
CBGH34	Glashyllplan Glas shelf						+550	
CBTHB34	LED inkl. trähyllplan ask LED incl. wooden shelf ash						+1650	
CBTR73	Trärygg ask Wooden back ash						+840	
CBGS74	Glassidor Sides of glass						+1310	
CBGD73	Glasdörr enkel Door of glass single						+1640	
CBGHM34	Glashyllplan placeras mitten av hylla Glass shelf placed in the middle of shelf						+1210	



3xCB734 trähyllplan nedtill wooden shelf below H360 W720 D240 invD 200 | 2xCB334 trähyllplan nedtill wooden shelf below H360 W360 D240 invD200, CBTR33 rygg | 2 x CB734 H720 W360 D240 invD200, CBTR73 rygg back, CBGS74 glassidor glass sides CBGD73 glasdörr enkel glass door single



Hylla Shelf CB374 trähyllplan nedtill wooden shelf below H360 W720 D240 invD200 | Pall Stool MILO | Pelarbord Pedestal table WOODWORK



CB374, H360 W720 D240 invD200, trähyllplan nedtill och upptill med LED. Glassidor, glasdörrar och rygg. Wooden shelf below and above incl. LED. Glass sides, doors and wooden back| CB334, H360 W360 D240 invD200, trähyllplan nedtill wooden shelf below



Hylla Shelf CB354, CB334 trähyllplan nedtill wooden shelf below H360 W540 and W360 D240 invD 200 | Stol Chair SANDER LOUNGE | Bord Table HITO

CHESS Malin Lundmark 2010

Klädhängare. Vägghängd. Massiv trä.
Coat hanger. Wall mounted. Solid wood.



CSK kung king
CSQ drottning queen
CSP bonde pawn

Chess SEK

Artno	Djup Depth mm	Diam mm	.50s Svart Black .50v Vit White	Vikt netto Weight net kilos
CSK	118	100	560	0,5
CSQ	138	100	560	0,5
CSP	105	92	560	0,5

KNOB Patrik Hansson 2010

Klädhängare. Vägghängd.
Coat hanger. Wall mounted.



KN1
Massiv trä. 4-pack.
Solid wood. Set of 4pcs.

KNDS
Dörrstopp svart gummi. 4-pack.
Door stop black rubber. Set of 4pcs.

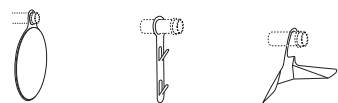

KNS
Spegel metall.
Mirror metal.

KNH2
Krokar metall.
Coat hook metal.

KNG
Galge metall.
Coat hanger metal.

Knob SEK

Artno	Djup Depth mm	Bredd Width mm	Höjd Height mm	Diam mm	s = Svart Black v = Vit White	Vikt netto Weight net kilos
KN1.30	95			46	810	0,5
KNDS					80	
KNS1			295	240	580	0,5
KNH2			225		380	0,5
KNG1		430	140		520	0,5

NEST Gabriella Lenke Mattias Ståhlbom 2007

Klädhängare. Massiv trä. Coat hanger. Solid wood.

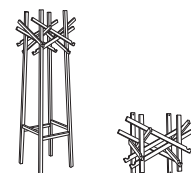

NEV1
golv / floor

NEG1
vägg / wall

Nest SEK

Extra SEK

Artno	Bredd Width mm	Djup Depth mm	Höjd Height mm	.10 ek oak .20 björk birch .50 lack color	Standardbets, Vitpigment på ek Standard stain White glazed on oak	Vikt netto Weight net kilos	Volym Volume net
NEG1	500	500	1750	10510	+1570	16	0,73
NEV1	600	300	600	7220	+1080	6	0,2

Klädhängare.
Vägghängd. Kompaktlaminat.

Coat rack
Wall model. Compact laminate.

Artno

Vägghängd Wall mounted



PO12



PO25



PO50



PO75



PO100

ponoq SEK

Artno	Bredd Width mm	Djup Depth mm	Höjd Height mm	ponoq SEK		Vikt netto Weight net kilos	Volym Volume net
				UTSIDA/insida .60 VIT/svart .61 SVART/vit	OUTSIDE/inside WHITE/black BLACK/white		
Vägghängd Wall mounted							
PO12	124	16/50	140	1260		0,5	0,001
PO25	248	16/50	140	1810		1	0,002
PO50	498	16/50	140	2600		2	0,01
PO75	744	16/50	140	3930		3	0,02
PO100	996	16/50	140	4430		4	0,03

FRONT KLÄDHÄNGARE COAT HANGER Skala Design 2004

Front Klädhängare. Massiv trä. Hängare av massiv wenge. Skruvas upp i vägg. Specialmått och andra utförande efter förfrågan. Vid beställning ange artikelnummer och utförande på trälist.

Front Coat hanger. Solid wood. Hooks in solid wenge. Secured directly to the wall. Special sizes and other finishes upon request.. Vid beställning ange artikelnummer och utförande på trälist.

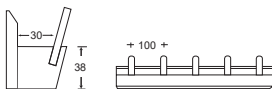

FR4 25



FR4 50



FR4 100



FR4 150



FR4 200

Front coat hanger SEK

Extra SEK

Artno	Bredd Width mm	Djup Depth mm	Höjd Height mm	Front coat hanger SEK		Standardbets på ek Standard stain on oak Vitpigment ek White glazed oak	Vikt netto Weight net kilos	Volym Volume net
				.10 ek oak .20 björk birch	.50 Lack Color			
Klädhängare Coat hanger								
FR4 25 Tre hängare Three hangers	250	60	75	2070	2410	+200	1	0,01
FR4 50 Fem hängare Five hangers	500	60	75	2440	2870	+240	1	0,02
FR4 100 Tio hängare Ten hangers	1000	60	75	3840	4420	+380	2	0,03
FR4 150 Femton hängare Fifteen hangers	1500	60	75	5280	6040	+530	3	0,04
FR4 200 Tjugo hängare Twenty hangers	2000	60	75	6640	7640	+660	4	0,05

COLLAR Louise Hederström 2011



Tidskrifts- och broschyrförvaring.
Fanerad MDF. Väggh monterad.

COT11011 har fem flyttbara avdelare vilket ger fyra fack.

Magazine and brochure storage.

Veneered MDF. Wall mounted

COT11011 has five adjustable dividers, get four sections.

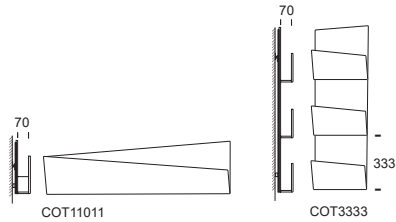

Collar SEK

Extra SEK

Artno	Bredd Width mm	Djup Depth mm	Höjd Height mm	Collar SEK		Extra SEK		
				.10 ek oak .20 björk birch .30 ask ash	.50 lack color	Standardbets på ask Standard stain on ash	Vikt netto Weight net kilos	Volym Volume net
COT11011	1128	107	316	4410	3840	+660	8	0,08
COT3333	355	107	1029	6220	5410	+940	9	0,08

ARC Sanna Lindström 2019

Utgående produkt med reservation för slutförsäljning.

Tidskrifts- och broschyrförvaring.

Ram massivträ. Front i fanerad plywood. Rygg fanerad MDF. Väggh monterad.

Outbound product with reservation for end of stock.

Magazine and brochure storage.

Frame in solid wood. Front in veneered plywood. Back veneered MDF. Wall mounted.

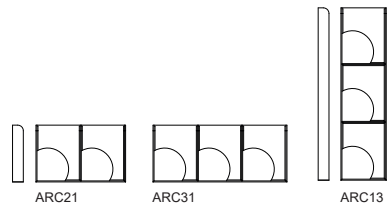

Arc SEK

Extra SEK

Artno	Bredd Width mm	Djup Depth mm	Höjd Height mm	Fack Invändigt mått Partition internal dimension W/D/H	Arc SEK		Extra SEK		
					.10 ek oak .20 björk birch .30 ask ash	.50 lack color	Standardbets på ask Standard stain on ash	Vikt netto Weight net kilos	Volym Volume net
ARC21	540	77	342	249/53/330	4820	4660	+730	6	0,03
ARC31	807	77	342	249/53/330	5740	5520	+860	7	0,04
ARC13	273	77	1038	249/53/330	5960	5770	+880	7	0,04

1KM DISPLAY Kristofer Jonsson Fanny Jiseborn, white 2016

Förvaring.

1KM Display en förvaring till sovrum, kök, kontor, hall mm. Vägghängd i massiv trä. Klarlack. Skruvas upp i vägg.

Storage.

1KM Display a storage for bedrooms, kitchen, office, hall etc. Wall mounted. Solid wood clear lacquer. Screwed up into the wall.

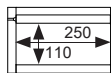

1KMV1



1KMV2

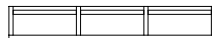

1KMV3

Tillbehör Accessories



1KML låda drawer
CL lås lock

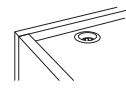

TKB11

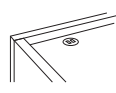

TKB13

1KM Display SEK

Extra SEK

Artno	Bredd Width mm	Djup Depth mm	Höjd Height mm	1KM Display SEK		Extra SEK			
				.10 ek oak .30 ask ash	.50 Lack Color	Standardbets på ask Standard stain on ash	Vikt netto Weight net kilos	Volym Volume net	
1KMV1	379	272	174	5710	4070	+840	8	0,03	
1KMV2	736	272	174	8660	5820	+1300	14	0,05	
1KMV3	1093	272	174	11630	7660	+1740	18	0,09	
Tillbehör Accessories									
1KML låda drawer. invändigt/internal D218	332	250	107	2350	2350	+360	1,3		
CL lås förnicklat lock nickelplated				1030					
TKB11 Powerdot Mini diam 57mm. 1 eluttag, 1,5m kabel. Svart. Placeras på hyllans ovansida. Gäller för SE,NO,DK,DK,FIN,DE,NL. Powerdot Mini diam 57mm. 1 electrical outlet,1,5m cable. Black. Placed on the top of the shelf. For SE,NO,DK,DK,FIN,DE,NL.				810	svart black				
TKB13 Powerdot Micro diam 35mm. 1xUSB A, 1xUSB C, 1,5m kabel. Svart. Placeras på hyllans ovansida. Gäller för SE,NO,DK,DK,FIN,DE,NL. Powerdot Micro diam 35mm, 1xUSB A, 1xUSB C. 1,5m cable. Black. Placed on the top of the shelf. For SE,NO,DK,DK,FIN,DE,NL.				1240	svart black				

FRONT LIST LEDGE

Skala Design 2004  Möbelfakta

Front List. Massiv trä. Skruvas upp i vägg. Härdat klarglas som standard, vilket sätts i skåran av listen. Plexi finns mot tillägg och ska anges vid beställning. Andra träslag och färger än standard begär offert.

Vid beställning ange artikelnummer, utförande och höjd på glas.

Speciallängd: Pris tag närmast övre längd +760SEK.

Front ledge. Solid wood. All sizes are secured directly to the wall. As standard tempered clear glass which inserted in the groove of the ledge. Plexi as extra cost and need to be state when ordering Other wood or colors upon request.

State when ordering: article number, finish and height of glass.

Special lengths: Take price of next length +760SEK

Artno

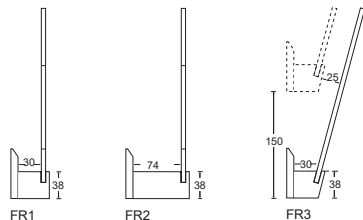

FR1

FR2

FR3



FR1 = D54



FR2 = D98



FR3

Tillbehör Accessories



FRAV 1 Avdelare Divider
FRAV 2 Avdelare Divider to FR2 to FR1, FR3

Front List SEK			Extra SEK		
----------------	--	--	-----------	--	--

Artno	Bredd Width mm	Djup Depth mm	Höjd Height mm	Klarglas höjd Clear glass height mm	.10 ek oak .20 björk birch	.50 Lack Color	Standardbets på ek Standard stain on oak Vitpigment ek White glazed oak	Plexi glas FRP	Gelelim till glas Gele glue for glass 3gr/tube FRLIM	Vikt netto Weight net kilos	Volym Volume net
Rak list Straight ledge D54											
FR1 25	250	54	70	32/150/230	1660	1910	+180	+260	+170	1/1/2	0,01
FR1 50	500	54	70	32/150/230	2040	2370	+200	+370	+170	1/2/3	0,01
FR1 100	1000	54	70	32/150/230	2950	3400	+290	+530	+170	2/4/6	0,01/0,01/0,02
FR1 150	1500	54	70	32/150/230	3860	4440	+380	+750	+170	3/6/9	0,01/0,01/0,02
FR1 200	2000	54	70	32/150/230	4970	5740	+500	+930	+170	4/9/11	0,01/0,02/0,03
Rak list Straight ledge D98											
FR2 25	250	98	70	32/150/230	1940	2310	+200	+260	+170	2/2/3	0,01/0,01/0,02
FR2 50	500	98	70	32/150/230	2360	2690	+240	+370	+170	2/3/4	0,01/0,01/0,02
FR2 100	1000	98	70	32/150/230	3560	4070	+360	+530	+170	3/5/7	0,01/0,01/0,03
FR2 150	1500	98	70	32/150/230	4720	5430	+460	+750	+170	4/7/10	0,01/0,02/0,04
FR2 200	2000	98	70	32/150/230	6060	6960	+600	+930	+170	5/10/12	0,02/0,03/0,05
Snedställd list Sloping ledge											
FR3 25	250	54/105	70	150/230	1660	1910	+180	+260	+170	1/2	0,01
FR3 50	500	54/105	70	150/230	2040	2370	+200	+370	+170	2/3	0,01
FR3 100	1000	54/105	70	150/230	2950	3400	+290	+530	+170	4/6	0,01/0,02
FR3 150	1500	54/105	70	150/230	3860	4440	+380	+750	+170	6/9	0,01/0,02
FR3 200	2000	54/105	70	150/230	4970	5740	+500	+930	+170	9/11	0,02/0,03
Tillbehör Accessories Avdelare Divider											
FRAV1	12	44	38		170	170	+20				
FRAV2	12	88	38		180	180	+20				

FRONT HYLLA SHELF Skala Design 2012

Front Hylla. Massiv trä. Skruvas upp i vägg.
Samtliga hyllor skruvas rakt in i vägg, djup 250 mm förstärks även med dold konsol. Andra träslag och färger än standard begär offert.

Vid beställning ange artikelnummer och utförande.

Speciallängd: Pris tag närmast övre längd +760 SEK.

Front shelf. Solid wood. All sizes are secured directly to the wall. The 250 mm deep shelf is reinforced with a hidden bracket. Other wood or colors upon request. State when ordering: article number and finish.

Special lengths: Take price of next length +760 SEK

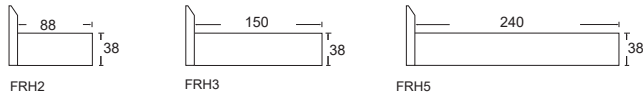

Artno	Maxvikt per hylla Max load per shelf kilos	Bredd Width mm	Djup Depth mm	Höjd Height mm	Front Hylla SEK		Extra SEK		
					.10 ek oak .20 björk birch	.50 Lack Color	Standardbets på ek Standard stain on oak	Vikt netto Weight net kilos	Volym Volume net
Hylla Shelf D98									
FRH2 25	8	250	98/88	70	1780	2010	+180	2	0,01
FRH2 50	10	500	98/88	70	2230	2510	+230	2	0,01
FRH2 100	15	1000	98/88	70	3360	3840	+340	3	0,01
FRH2 150	20	1500	98/88	70	4420	5080	+440	4	0,01
FRH2 200	25	200	98/88	70	5870	6760	+580	5	0,02
Hylla Shelf D160									
FRH3 25	8	250	160/150	70	2350	2690	+230	2	0,01
FRH3 50	10	500	160/150	70	2950	3420	+290	3	0,01
FRH3 100	15	1000	160/150	70	4240	4860	+430	6	0,01
FRH3 150	20	1500	160/150	70	5350	6150	+550	9	0,02
FRH3 200	25	2000	160/150	70	6920	7940	+700	12	0,03
Hylla Shelf D250									
FRH5 25	10	250	250/240	70	2940	3400	+290	3	0,01
FRH5 50	20	500	250/240	70	3710	4270	+370	5	0,01
FRH5 100	30	1000	250/240	70	5240	6040	+530	8	0,02
FRH5 150	40	1500	250/240	70	6880	7910	+700	10	0,03
FRH5 200	50	2000	250/240	70	8640	9930	+860	15	0,04

FRONT PLANT Skala Design 2009

Front Plant. En kombination av list och glaslåda (L500mm) för exempelvis växter. List massiv trä. Skruvas upp i vägg. Glaslåda sätts i skåran av listen.

Andra träslag och färger än standard begär offert.

Vid beställning ange artikelnummer, utförande på list och glaslåda.

Front Plant. A combination of a wood ledge and glass box (L500mm) for plants. Ledge in solid wood. Secured directly to the wall. Glass box is inserted in the groove of the ledge. Other wood or colors upon request. State when ordering: article number and finish of ledge and glass box.

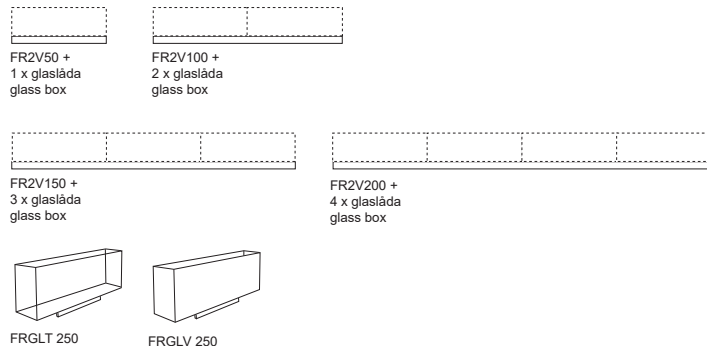

Artno	Bredd Width mm	Djup Depth mm	Höjd Height mm	Front Plant SEK		Extra SEK		
				.10 ek oak .20 björk birch	.50 Lack Color	Standardbets på ek Standard stain on oak	Vikt netto Weight net kilos	Volym Volume net
Vägglist Wall ledge								
FR2V 50	500	98	38/70	2290	2590	+230	2	0,01
FR2V 100	1000	98	38/70	3440	3960	+340	4	0,01
FR2V 150	1500	98	38/70	4590	5300	+450	6	0,01
FR2V 200	2000	98	38/70	5980	6840	+590	9	0,02
Glaslåda Glass box								
FRGLT 250 Transparent	500	88	150	2420 transparent			5	
FRGLV 250 Vit White	500	88	150	2810 vit white			5	

FRONT TAVLA BOARD Skala Design 2007

Front tavla, används som skylt eller där du snabbt kan byta papper för olika meddelande, fotografier eller vill exponera en affisch. List och glas har tunnare dimensioner än övriga Front. Front tavla består av liggande och stående A4 och A3 som skruvas direkt på vägg. Alternativt är ett antal liggande och stående A4 som är monterat på en träpanel.

På ryggen finns ett grepp som gör det enkelt att snabbt byta papper.

Affisch tavla för affischstorlek 700x500 respektive 1000x700mm.

Panel och affischtavla hängs på vägg med metallist. List i massivt trä och rygg i MDF av faner. Ytbehandling klarlack. Härdat klarglas som standard. Mot tillägg finns plexiglas. Specialmått och andra utförande efter förfrågan.

Front board is a wall-mounted board for use as the backing for a sign or for displaying messages and changing them quickly and easily. Front display boards are available in A4 and A3 portrait and landscape formats, secured directly to the wall. The ledge and glass are slightly thinner than in the rest of the Front range. Alternatively, a number of landscape and portrait A4 which is mounted on a wood panel.

On the back there is a handle which makes it easy to change document. Billboard for poster-size 700x500 or 1000x700mm. Panel and billboard is mounted on the wall with a metal suspension strip. Ledge in solid wood and back in MDF. Finish clear lacquer. Tempered clear glass as standard and plexi glass upon request. Special sizes and other finishes upon request.

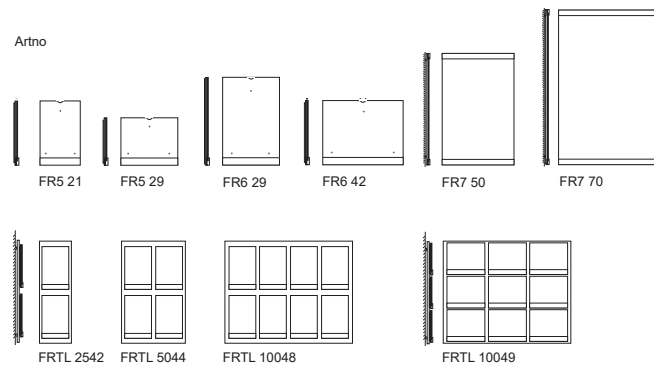

Artno	Bredd Width mm	Djup Depth mm	Höjd Height mm	Inv D Internal	Front Tavla Board SEK		Extra SEK		
					.10 ek oak .20 björk birch .50 lack color	Standardbets på ek Standard stain on oak Vitpigment ek White glazed oak	Plexi glas FRP	Vikt netto Weight kilos	Volym Volume net
FR5 21	210	27	335	2	1290	+150	+260	2	0,002
FR5 29	297	27	248	2	1290	+150	+260	2	0,003
FR6 29	297	27	458	2	1660	+180	+360	4	0,005
FR6 42	420	27	335	2	1660	+180	+360	4	0,005
Affisch Poster									
FR7 50	500	38	776	2	3050	+310	+500	9	0,03
FR7 70	700	38	1076	2	4880	+470	+750	17	0,08
Panel									
FRTL 2542	250	55	800	2	5290	+530	+550	7	0,03
FRTL 5044	500	55	800	2	8560	+840	+1080	13	0,05
FRTL 10048	1000	55	800	2	14820	+1500	+2150	26	0,12
FRTL 10049	1000	55	800	2	16110	+1610	+2420	28	0,12

FRONT PANEL Skala Design 2007



Front panel används som tidskrifts-, broschyrställ, spegel, anslagstavla, skrivtavla eller en kombination av dessa. Beklädnad av rygg finns att välja mellan raka eller vinklade lister, magnetisk whiteboard inklusive ett antal magneter, Bulletin Board 2204, klädd i tyg Europost från Gabriel och spegel. Specialmått och andra utförande efter förfrågan.

Panelen hängs på vägg med metallist. Listerna i massivt trä och rygg i MDF av faner. Ytbehandling klarlack. Hårdat klarglas i höjderna 32, 150 (=A5) or 230 (=A4) mm. Som tillägg finns plexiglas. Istället för glas till magnetisk whiteboard eller anslagstavla kan man välja 15 mm hög träavslut. Tillbehör: Avdelare i massiv trä som sätts på glaset för indelning i fack. Extra magneter till whiteboard.

Rygg
FRB = Bulletin Board col 2204 (kantlist endast i vit, svart, ek, björk)
FRK = Klädd i tyg Europost
FRW = Magnetic Whiteboard (kantlist endast i vit, svart , ek eller björk)
FRS = Spegel

Front panel is a magazine rack, a brochure stand, a mirror, a writing and noticeboard – or a combination of all these functions. You can choose the back of straight or sloping ledge, magnetic whiteboard included some magnets, Bulletin Board 2204, covered in any color of fabric Europost from Gabriel and mirror. Special sizes and ther finishes upon request.

It is secured to the wall using a metal rail. The ledges in solid wood and back in MDF of veneer. Finish clear lacquer. Tempered clear glass in height 32, 150 (=A5) or 230 (=A4) mm as standard and plexiglass upon request. Instead of glass for magnetic whiteboard and notice board you can choose of 15 mm wood end. Accessories: Dividers in solid wood that slot on top of the glass fronts to divide each shelf into compartments.

Back
FRB = Bulletin Board col 2204 (edge only in white, black, oak or birch)
FRK = Covered in fabric Europost
FRW = Magnetic Whiteboard (edge only in white, black, oak or birch)
FRS = Mirror

Front panel utan list.

FRB = Bulletin Board col 2204 (kantlist endast i vit, svart, ek, björk)
FRK = Klädd i tyg Europost
FRW = Magnetic Whiteboard (kantlist endast i vit, svart, ek, björk)
FRS = Spegel

Front panel excl. ledge.

Back
FRB = Bulletin Board col 2204 (edge only in white, black, oak, birch)
FRK = Covered in fabric Europost
FRW = Magnetic Whiteboard (edge only in white, black, oak, birch)
FRS = Mirror

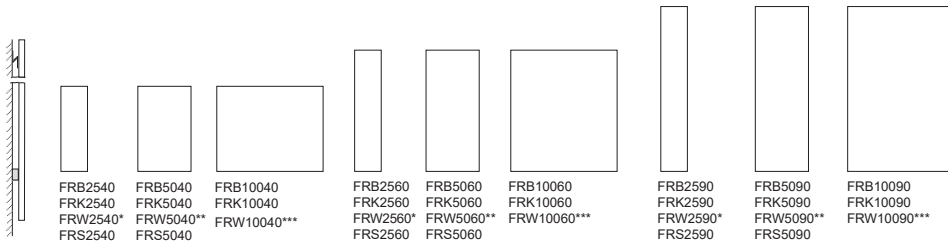

*incl. 3 magnets
**incl. 4 magnets
***incl. 6 magnets

Tillbehör Accessories



FRM
Magnet ø11

Artno	Bredd Width mm	Djup Depth mm	Höjd Height mm	Panel SEK	Extra SEK	Vikt netto Weight net kilos	Volym Volume net
				.10 ek oak .20 björk birch .50 lack color	Standardbets på ek Standard stain on oak Vitpigment ek White glazed oak		
FRB2540	250	30	800	3060	+310	4	0,03
FRK2540	250	30	800	4920	+500	4	0,03
FRW2540	250	30	800	3580	+360	4	0,03
FRS2540	250	30	800	3180	+310	4	0,03
FRB5040	500	30	800	3820	+380	7	0,05
FRK5040	500	30	800	5840	+580	7	0,05
FRW5040	500	30	800	4820	+470	7	0,05
FRS5040	500	30	800	4210	+430	7	0,05
FRB10040	1000	30	800	5100	+520	14	0,1
FRK10040	1000	30	800	6880	+700	14	0,1
FRW10040	1000	30	800	6930	+700	14	0,1
FRB2560	250	30	1140	3570	+360	6	0,04
FRK2560	250	30	1140	5320	+550	6	0,04
FRW2560	250	30	1140	4160	+420	6	0,04
FRS2560	250	30	1140	3790	+380	6	0,04
FRB5060	500	30	1140	4640	+460	13	0,07
FRK5060	500	30	1140	6330	+630	13	0,07
FRW5060	500	30	1140	5860	+580	13	0,07
FRS5060	500	30	1140	4910	+500	13	0,07
FRB10060	1000	30	1140	6460	+630	20	0,15
FRK10060	1000	30	1140	8300	+830	20	0,15
FRW10060	1000	30	1140	8460	+840	20	0,15
FRB2590	250	30	1550	4070	+420	11	0,06
FRK2590	250	30	1550	6520	+640	11	0,06
FRW2590	250	30	1550	5010	+500	11	0,06
FRS2590	250	30	1550	4260	+430	11	0,06
FRB5090	500	30	1550	5400	+550	18	0,1
FRK5090	500	30	1550	7790	+790	18	0,1
FRW5090	500	30	1550	7070	+710	18	0,1
FRS5090	500	30	1550	5750	+580	18	0,1
FRB10090	1000	30	1550	7650	+770	25	0,11
FRK10090	1000	30	1550	9630	+980	25	0,11
FRW10090	1000	30	1550	10290	+1030	25	0,11
Tillbehör Accessories							
FRM magnet			10	100			

FRONT PANEL Skala Design 2007

Front panel med en rak list.
Mer information se sid 26.

Rygg
FRB = Bulletin Board col 2204 (kantlist endast i vit, svart, ek, björk)
FRK = Klädd i tyg Europost
FRW = Magnetic Whiteboard (kantlist endast i vit, svart, ek, björk)
FRS = Spegel

Front panel incl. one straight ledge.
More information see page 26.

Back
FRB = Bulletin Board col 2204 (edge only in white, black, oak, birch)
FRK = Covered in fabric Europost
FRW = Magnetic Whiteboard (edge only in white, black, oak, birch)
FRS = Mirror

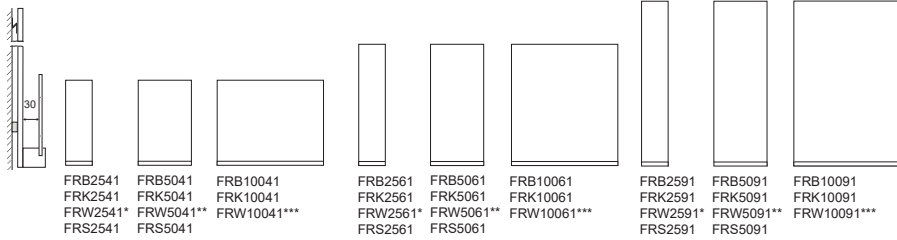

*incl. 3 magnets
**incl. 4 magnets
***incl. 6 magnets

Tillbehör Accessories



FRAV 1



FRM
Magnet ø11

Artno	Bredd Width mm	Djup Depth mm	Höjd Height mm	Glashöjd Glass height mm	Träavslut Wood end mm	Panel SEK	Extra SEK	Plexi FRP	Vikt netto Weight net kilos	Volym Volume net
						.10 ek oak .20 björk birch .50 lack color	Standardbets på ek Standard stain on oak Vitpigment ek White glazed oak			
FRB2541	250	70	800	32/150/230	15	4010	+400	+260	5	0,03
FRK2541	250	70	800	32/150/230	15	5840	+580	+260	5	0,03
FRW2541	250	70	800	32/150/230	15	4520	+450	+260	5	0,03
FRS2541	250	70	800	32/150/230	15	4090	+420	+260	5	0,03
FRB5041	500	70	800	32/150/230	15	5100	+520	+370	12	0,05
FRK5041	500	70	800	32/150/230	15	7110	+710	+370	12	0,05
FRW5041	500	70	800	32/150/230	15	6100	+600	+370	12	0,05
FRS5041	500	70	800	32/150/230	15	5480	+560	+370	12	0,05
FRB10041	1000	70	800	32/150/230	15	7040	+710	+530	14	0,11
FRK10041	1000	70	800	32/150/230	15	8930	+880	+530	14	0,11
FRW10041	1000	70	800	32/150/230	15	8840	+870	+530	14	0,11
FRB2561	250	70	1140	32/150/230	15	4500	+450	+260	7	0,04
FRK2561	250	70	1140	32/150/230	15	6250	+610	+260	7	0,04
FRW2561	250	70	1140	32/150/230	15	5090	+520	+260	7	0,04
FRS2561	250	70	1140	32/150/230	15	4700	+460	+260	7	0,04
FRB5061	500	70	1140	32/150/230	15	5960	+590	+370	16	0,07
FRK5061	500	70	1140	32/150/230	15	7630	+770	+370	16	0,07
FRW5061	500	70	1140	32/150/230	15	7180	+730	+370	16	0,07
FRS5061	500	70	1140	32/150/230	15	6250	+610	+370	16	0,07
FRB10061	1000	70	1140	32/150/230	15	8380	+830	+530	25	0,15
FRK10061	1000	70	1140	32/150/230	15	10210	+1020	+530	25	0,15
FRW10061	1000	70	1140	32/150/230	15	10350	+1030	+530	25	0,15
FRB2591	250	70	1550	32/150/230	15	5010	+500	+260	8	0,06
FRK2591	250	70	1550	32/150/230	15	7470	+750	+260	8	0,06
FRW2591	250	70	1550	32/150/230	15	5960	+590	+260	8	0,06
FRS2591	250	70	1550	32/150/230	15	5210	+530	+260	8	0,06
FRB5091	500	70	1550	32/150/230	15	6700	+660	+370	17	0,1
FRK5091	500	70	1550	32/150/230	15	9070	+890	+370	17	0,1
FRW5091	500	70	1550	32/150/230	15	8350	+830	+370	17	0,1
FRS5091	500	70	1550	32/150/230	15	7080	+710	+370	17	0,1
FRB10091	1000	70	1550	32/150/230	15	9540	+960	+530	34	0,2
FRK10091	1000	70	1550	32/150/230	15	11530	+1140	+530	34	0,2
FRW10091	1000	70	1550	32/150/230	15	12200	+1230	+530	34	0,2
Tillbehör Accessories										
FRAV1	12	44	38			170	+20			
FRM			10			100				

FRONT PANEL Skala Design 2007



Front panel med raka lister.
Mer information se sid 26.

Front panel incl. straight ledges.
More information see page 26.



Front panel med vinklade lister.
Mer information se sid 32.

Front panel incl. sloping ledges.
More information see page 32.

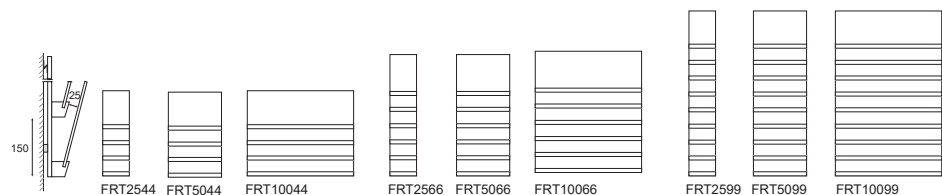

Front panel med vinklade lister.
Mer information se sid 32.

Front panel incl. sloping ledges.
More information see page 32.

Rygg
FRB = Bulletin Board col 2204 (kantlist endast i vit, svart, ek, björk)
FRK = Klädd i tyg Europost
FRW = Magnetic Whiteboard (kantlist endast i vit, svart, ek, björk)

Back
FRB = Bulletin Board col 2204 (edge only in white, black, oak, birch)
FRK = Covered in fabric Europost
FRW = Magnetic Whiteboard (edge only in white, black, oak, birch)

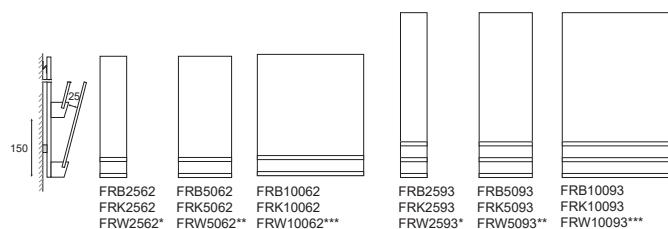

*incl. 3 magnets
**incl. 4 magnets
***incl. 6 magnets

Tillbehör Accessories

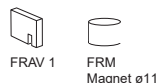

Artno	Bredd Width mm	Djup Depth mm	Höjd Height mm	Glashöjd Glass height mm	.10 ek oak .20 björk birch .50 lack color	Standardbets på ek Standard stain on oak Vitpigment ek White glazed oak	Plexi FRP	Vikt netto Weight net kilos	Volym Volume net
FRT2542	250	70	800	230	4520	+450	+550	6	0,03
FRT5042	500	70	800	230	5990	+590	+740	11	0,05
FRT10042	1000	70	800	230	8240	+820	+1040	22	0,1
FRT2563	250	70	1140	230	5940	+590	+810	9	0,04
FRT5063	500	70	1140	230	7850	+790	+1100	19	0,07
FRT10063	1000	70	1140	230	10920	+1090	+1560	33	0,15
FRT2594	250	70	1550	230	7330	+740	+1080	11	0,06
FRT5094	500	70	1550	230	9740	+990	+1470	23	0,1
FRT10094	1000	70	1550	230	13570	+1360	+2100	25	0,15
FRT2544	250	115	800	230	6600	+640	+1080	10	0,03
FRT5044	500	115	800	230	8780	+870	+1470	17	0,05
FRT10044	1000	115	800	230	12230	+1230	+2100	34	0,1
FRT2566	250	115	1140	230	9040	+890	+1610	12	0,04
FRT5066	500	115	1140	230	12060	+1210	+2220	24	0,07
FRT10066	1000	115	1140	230	16970	+1700	+3160	50	0,15
FRT2599	250	115	1550	230	12430	+1260	+2420	18	0,06
FRT5099	500	115	1550	230	16710	+1670	+3300	33	0,13
FRT10099	1000	115	1550	230	23650	+2510	+4710	66	0,2
FRB2562	250	115	1140	150/230	5490	+560	+550	8	0,04
FRK2562	250	115	1140	150/230	7320	+740	+550	8	0,04
FRW2562	250	115	1140	150/230	6060	+600	+550	8	0,04
FRB5062	500	115	1140	150/230	7280	+730	+740	17	0,07
FRK5062	500	115	1140	150/230	9040	+890	+740	17	0,07
FRW5062	500	115	1140	150/230	8540	+840	+740	17	0,07
FRB10062	1000	115	1140	150/230	10350	+1030	+1040	35	0,15
FRK10062	1000	115	1140	150/230	12210	+1230	+1040	35	0,15
FRW10062	1000	115	1140	150/230	12340	+1240	+1040	35	0,15
FRB2593	250	115	1550	150/230	7010	+700	+810	10	0,06
FRK2593	250	115	1550	150/230	9460	+960	+810	10	0,06
FRW2593	250	115	1550	150/230	7830	+790	+810	10	0,06
FRB5093	500	115	1550	150/230	9470	+960	+1100	21	0,1
FRK5093	500	115	1550	150/230	11810	+1160	+1100	21	0,1
FRW5093	500	115	1550	150/230	10920	+1090	+1100	21	0,1
FRB10093	1000	115	1550	150/230	13540	+1350	+1560	42	0,2
FRK10093	1000	115	1550	150/230	15520	+1550	+1560	42	0,2
FRW10093	1000	115	1550	150/230	15920	+1580	+1560	42	0,2
FRAV1	12	44	38		170	+20			
FRM			10		100				

FRONT FÖRVARING STORAGE Skala Design 2007

Front förvaring. Ryggen i trä med monterade raka eller vinklade lister för tidningar, broschyrer och magasin. Bakom finns det utrymme för extra förvaring. Lister är i massiv trä och rygg i MDF av faner. Härdad klarglas i höjd 230 mm. Som tillägg finns plexiglas. Förvaringen hängs på vägg med metallist. Specialmått och andra utförande efter förfrågan. Som tillbehör finns avdelare i massiv trä som sätts på glaset för indelning i fack.

Front storage. Back of wood with straight or sloping ledges for magazines and brochures. Behind extra storage spaces. Ledges in solid wood and back in veneered MDF. Tempered clear glass in height 230 mm (=A4) as standard. Plexi glass, special sizes and other finishes upon request. It is secured to the wall using a metal rail. Accessories dividers in solid wood that slot on top of the glass fronts to divide each shelf into compartments.

Raka lister. Straight ledges.

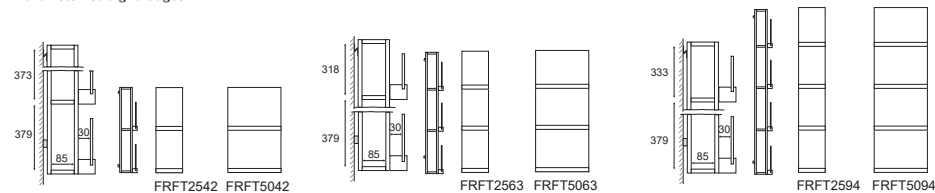

Vinklade lister. Sloping ledges

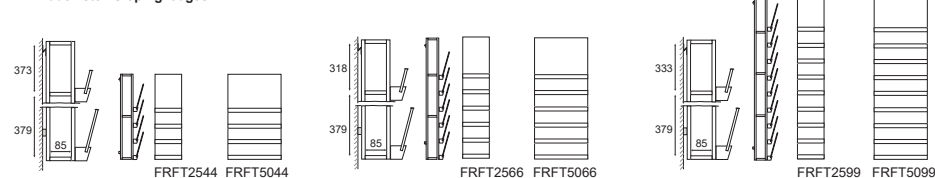

Tillbehör Accessories



FRAV 1
Avdelare Divider
to FR1, FR3

	Förvaring SEK	Extra SEK
--	---------------	-----------

Artno	Bredd Width mm	Djup Depth mm	Höjd Height mm	Glashöjd Glass height mm	.10 ek oak .20 björk birch .50 lack color	Standardbets på ek Standard stain on oak Vitpigment ek White glazed oak	Plexi FRP	Vikt netto Weight net kilos	Volym Volume
FRFT2542	250	175	800	230	8220	+820	+550	12	0,05
FRFT5042	500	175	800	230	10780	+1080	+740	22	0,1
FRFT2563	250	175	1140	230	10570	+1070	+810	16	0,08
FRFT5063	500	175	1140	230	13740	+1370	+1100	29	0,14
FRFT2594	250	175	1550	230	12980	+1300	+1080	21	0,12
FRFT5094	500	175	1550	230	16960	+1700	+1470	40	0,2
FRFT2544	250	225	800	230	9940	+1000	+1080	10	0,04
FRFT5044	500	225	800	230	13570	+1360	+1470	26	0,1
FRFT2566	250	225	1140	230	13640	+1360	+1610	20	0,08
FRFT5066	500	225	1140	230	17950	+1800	+2220	26	0,15
FRFT2599	250	225	1550	230	18100	+1810	+2420	22	0,1
FRFT5099	500	225	1550	230	23900	+2400	+3300	40	0,2
Tillbehör Accessories									
FRAV1	12	44	38		170	+20			

FRONT FRISTÅENDE FREE-STANDING

Skala Design 2006



Front fristående finns i följande tre kombinationer.

1. Utan lister med rygg i Bulletin Board 2204 eller magnetisk whiteboard inklusive magneter.
2. Tidsskriftsställ med raka eller vinklade lister monterade på en eller båda sidor av ryggen.
3. En kombination med raka eller vinklade lister med rygg i trä, Bulletin Board 2204 eller magnetisk whiteboard inklusive magneter.

Härdat klarglas i höjderna 150 (=A5) och 230 (=A4) mm. Mot tillägg finns plexiglas. Utförande foten och lister är massivt trä i ek, björk, standardfärger, standardbetsar på ek och vitpigmenterad ek. Ytbehandling klarlack. Specialmått och andra utförande efter förfrågan. Som tillbehör infrästa hjul i foten, ej låsbara. Extra magneter till whiteboard. Avdelare i massivt trä som sätts på glaset för indelning i fack.

Front free-standing comes in three different combinations.

1. Without ledges with back in Bulletin Board 2204 or magnetic whiteboard incl. magnets.
2. As magazine shelf with straight or slope ledges on both sides of back.
3. A combination of straight or sloping ledges and back in wood, Bulletin Board 2204 or magnetic whiteboard included magnets.

Tempered clear glass in height 150 (=A5) and 230 (=A4) mm as standard. Plexi glass upon request. Base and ledges are in solid wood of oak, birch, standard colors, standard stains on oak and white glazed oak. Finish clear lacquer. Special sizes and other finishes upon request. Accessories as invisible castors, not lockable, extra magnets for whiteboard, dividers in solid wood that slot on top of the glass fronts to divide each shelf into compartments.

Front fristående utan lister.

Rygg
FRDB = Bulletin Board col 2204 (kantlist endast i vit, svart, ek, björk)
FRDW = Magnetic Whiteboard (kantlist endast i vit, svart, ek, björk)

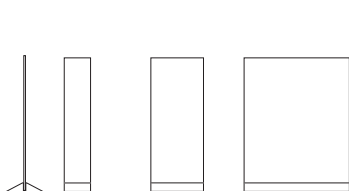

FRDB2560 FRDB5060 FRDB10060
FRDW2560* FRDW5060** FRDW10060***

Front free-standing without ledges.

Back
FRDB = Bulletin Board col 2204 (edge only in white, black, oak, birch)
FRDW = Magnetic Whiteboard (edge only in white, black, oak, birch)

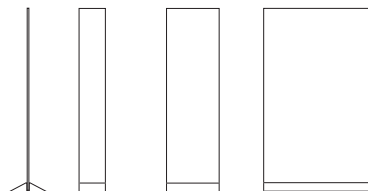

FRDB2590 FRDB5090 FRDB10090
FRDW2590* FRDW5090** FRDW10090***
*incl. 6 magnets
**incl. 8 magnets
***incl. 12 magnets

Front fristående vinklade lister.

Rygg
FREB = Bulletin Board col 2204 (kantlist endast i vit, svart, ek, björk)
FRET = Träpanel
FREW = Magnetic Whiteboard (kantlist endast i vit, svart, ek, björk)



FREB2566 FREB5066 FREB10066
FRET2566 FRET5066 FRET10066
FREW2566* FREW5066** FREW10066***

Front free-standing sloping ledges.

Back
FREB = Bulletin Board col 2204 (edge only in white, black, oak, birch)
FRET = Wooden panel
FREW = Magnetic Whiteboard (edge only in white, black, oak, birch)

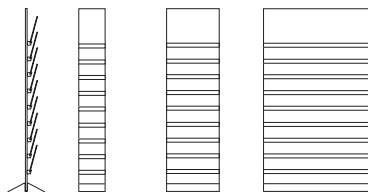

FREB2599 FREB5099 FREB10099
FRET2599 FRET5099 FRET10099
FREW2599* FREW5099** FREW10099***
*incl. 3 magnets
**incl. 4 magnets
***incl. 6 magnets

Front fristående vinklade lister.



FRDT2566 FRDT5066 FRDT10066

Front free-standing sloping ledges.

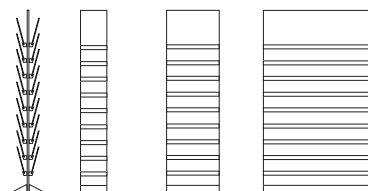

FRDT2599 FRDT5099 FRDT10099

Artno	Bredd Width mm	Djup Depth mm	Höjd Height mm	Glashöjd Glass height mm	Fothöjd Height of foot mm	Fristående SEK		Plexi FRP	Vikt netto Weight net kilos	Volym Volume net
						.10 ek oak .20 björk birch .50 lack color	Standardbets på ek Standard stain on oak Vitpigment ek White glazed oak			
FRDB2560	250	360	1300		95	7640	+770		7	0,15
FRDW2560	250	360	1300		95	8800	+870		7	0,15
FRDB5060	500	360	1300		95	10920	+1090		14	0,3
FRDW5060	500	360	1300		95	13450	+1350		14	0,3
FRDB10060	1000	360	1300		95	18560	+1860		28	0,6
FRDW10060	1000	360	1300		95	23200	+2320		28	0,6
FRDB2590	250	360	1750		95	8380	+830		12	0,2
FRDW2590	250	360	1750		95	10060	+1010		12	0,2
FRDB5090	500	360	1750		95	12210	+1230		24	0,4
FRDW5090	500	360	1750		95	15430	+1550		24	0,4
FRDB10090	1000	360	1750		95	20750	+2080		48	0,8
FRDW10090	1000	360	1750		95	26770	+2670		48	0,8
FREB2566	250	360	1300	150,230	95	12640	+1270	+1610	13	0,15
FRET2566	250	360	1300	150,230	95	11250	+1120	+1610	13	0,15
FREW2566	250	360	1300	150,230	95	13730	+1370	+1610	13	0,15
FREB5066	500	360	1300	150,230	95	18490	+1850	+2220	35	0,3
FRET5066	500	360	1300	150,230	95	16410	+1650	+2220	35	0,3
FREW5066	500	360	1300	150,230	95	20900	+2100	+2220	35	0,3
FREB10066	1000	360	1300	150,230	95	29390	+2940	+3160	52	0,52
FRET10066	1000	360	1300	150,230	95	25710	+2560	+3160	52	0,52
FREW10066	1000	360	1300	150,230	95	33870	+3400	+3160	52	0,52
FREB2599	250	360	1750	150,230	95	15910	+1580	+2420	23	0,2
FRET2599	250	360	1750	150,230	95	14330	+1440	+2420	23	0,2
FREW2599	250	360	1750	150,230	95	17460	+1740	+2420	23	0,2
FREB5099	500	360	1750	150,230	95	23550	+2360	+3300	32	0,4
FRET5099	500	360	1750	150,230	95	20980	+2100	+3300	32	0,4
FREW5099	500	360	1750	150,230	95	26680	+2660	+3300	32	0,4
FREB10099	1000	360	1750	150,230	95	36990	+3690	+4710	64	0,75
FRET10099	1000	360	1750	150,230	95	32270	+3230	+4710	64	0,75
FREW10099	1000	360	1750	150,230	95	42880	+4270	+4710	64	0,75
FRDT2566	250	360	1300	150,230	95	16260	+1640	+3230	23	0,15
FRDT5066	500	360	1300	150,230	95	23960	+2400	+4420	32	0,26
FRDT10066	1000	360	1300	150,230	95	36520	+3660	+6280	76	0,59
FRDT2599	250	360	1750	150,230	95	21850	+2170	+4850	25	0,22
FRDT5099	500	360	1750	150,230	95	32280	+3230	+6650	62	0,4
FRDT10099	1000	360	1750	150,230	95	48560	+4860	+9440	100	0,85

FRONT FRISTÅENDE FREE-STANDING Skala Design 2006



Front fristående raka lister.



Front free-standing straight ledges.

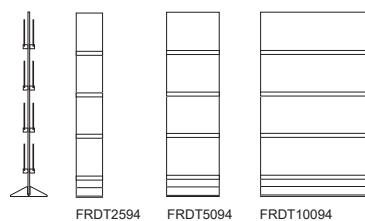

Front fristående raka lister.

Rygg
 FREB = Bulletin Board col 2204 (kantlist endast i vit, svart, ek, björk)
 FRET = Träpanel
 FREW = Magnetic Whiteboard (kantlist endast i vit, svart, ek, björk)



FREB2563
 FRET2563
 FREW2563*
 FREB5063
 FRET5063
 FREW5063**
 FREB10063
 FRET10063
 FREW10063***

Front free-standing straight ledges.

Back
 FREB = Bulletin Board col 2204 (edge only in white, black, oak, birch)
 FRET = Wooden panel
 FREW = Magnetic Whiteboard (edge only in white, black, oak, birch)



FREB2594
 FRET2594
 FREW2594*
 FREB5094
 FRET5094
 FREW5094**
 FREB10094
 FRET10094
 FREW10094***

*incl. 3 magnets
 **incl. 4 magnets
 ***incl. 6 magnets

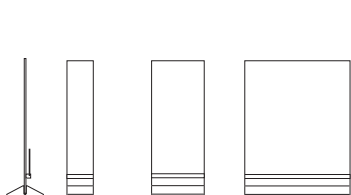

FREB2561
 FREW2561*
 FREB5061
 FREW5061**
 FREB10061
 FREW10061***



FREB2592
 FREW2592*
 FREB5092
 FREW5092**
 FREB10092
 FREW10092***

*incl. 3 magnets
 **incl. 4 magnets
 ***incl. 6 magnets

Tillbehör Accessories



FRAV 1
 Avdelare Divider
 to FR1, FR3



FRM
 Magnet ø11



FRH
 4st hjul ej låsbara
 4pcs castors, not lockable

Artno	Bredd Width mm	Djup Depth mm	Höjd Height mm	Glashöjd Glass height mm	Fothöjd Height of foot mm	.10 ek oak .20 björk birch .50 lack color	Standardbets på ek Standard stain on oak Vitpigment ek White glazed oak	Plexi FRP	Vikt netto Weight net kilos	Volym Volume net
FRDT2563	250	360	1300	150,230	95	11250	+1120	+1610	16	0,15
FRDT5063	500	360	1300	150,230	95	16410	+1650	+2220	32	0,3
FRDT10063	1000	360	1300	150,230	95	25710	+2560	+3160	55	0,7
FRDT2594	250	360	1750	150,230	95	13510	+1350	+2150	24	0,22
FRDT5094	500	360	1750	150,230	95	19710	+1970	+2950	34	0,4
FRDT10094	1000	360	1750	150,230	95	30470	+3050	+4210	68	0,8
FREB2563	250	360	1300	150,230	95	10150	+1020	+810	14	0,16
FRET2563	250	360	1300	150,230	95	8750	+870	+810	14	0,16
FREW2563	250	360	1300	150,230	95	11210	+1120	+810	14	0,16
FREB5063	500	360	1300	150,230	95	14720	+1470	+1100	28	0,26
FRET5063	500	360	1300	150,230	95	12630	+1270	+1100	28	0,26
FREW5063	500	360	1300	150,230	95	17140	+1710	+1100	28	0,26
FREB10063	1000	360	1300	150,230	95	23970	+2400	+1570	55	0,6
FRET10063	1000	360	1300	150,230	95	20270	+2020	+1570	55	0,6
FREW10063	1000	360	1300	150,230	95	28480	+2850	+1570	55	0,6
FREB2594	250	360	1750	150,230	95	11730	+1160	+1080	16	0,2
FRET2594	250	360	1750	150,230	95	10160	+1020	+1080	16	0,2
FREW2594	250	360	1750	150,230	95	13300	+1330	+1080	16	0,2
FREB5094	500	360	1750	150,230	95	17240	+1730	+1470	32	0,4
FRET5094	500	360	1750	150,230	95	14660	+1470	+1470	32	0,4
FREW5094	500	360	1750	150,230	95	20380	+2040	+1470	32	0,4
FREB10094	1000	360	1750	150,230	95	27940	+2800	+2100	67	0,8
FRET10094	1000	360	1750	150,230	95	23250	+2320	+2100	67	0,8
FREW10094	1000	360	1750	150,230	95	33840	+3400	+2100	67	0,8
FREB2561	250	360	1300	150,230	95	8460	+840	+260	8	0,15
FRET2561	250	360	1300	150,230	95	9640	+980	+260	8	0,15
FREW2561	250	360	1300	150,230	95	12190	+1230	+370	16	0,3
FREB5061	500	360	1300	150,230	95	14720	+1470	+370	16	0,3
FRET5061	500	360	1300	150,230	95	20380	+2040	+530	52	0,52
FREW5061	500	360	1300	150,230	95	24980	+2500	+530	52	0,52
FREB10061	1000	360	1300	150,230	95	10080	+1010	+550	14	0,2
FRET10061	1000	360	1300	150,230	95	11720	+1160	+550	14	0,2
FREW10061	1000	360	1300	150,230	95	14750	+1470	+740	28	0,4
FREB5092	500	360	1750	150,230	95	17950	+1800	+740	28	0,4
FRET5092	500	360	1750	150,230	95	24340	+2430	+1040	56	0,8
FREW5092	500	360	1750	150,230	95	30360	+3030	+1040	56	0,8
FRAV1	12	44	38			170	+20			
FRH						1350				

Ridå används som tidskrifts-, broschyrställ, spegel, anslagstavla, skrivtavla eller en kombination av dessa.

Facken är pressad formfilt, ljusgrå eller antracit och som ger en viss ljudabsorberande effekt.

Ramen tillverkas i fänerad MDF. Ytbehandling klarlack. Ridå hängs på vägg med metallist.

Välj ryggen i ljusgrå alternativt antracit filt, spegel, whiteboard, trä.

(Om filtack önskas kläs i tyg Comfort, återkom för offert).

Samtliga ryggar är magnetiska. Ridå i bredd 371 kan hängas både vertikalt och horisontellt.

Tillbehör: Aluminiumlist som kan användas som namnskylt.

Ridå is used as a magazine, brochure stand, mirror, bulletin board, writing board or a combination of these.

The compartments are pressed form felt, light gray or anthracite and which give a certain sound-absorbing effect.

The frame is made of veneered MDF surface treatment clear lacquer. Ridå is hung on the wall with a metal strip.

Choose the back in light gray alternative anthracite blanket, mirror, whiteboard, wood.

(If felt compartment is desired to be upholstered in fabric Comfort, please return for a quote)

All backs are magnetic. Ridå in width 371 can be hung both vertically and horizontally.

Accessories: Aluminum strip that can be used as a name plate.

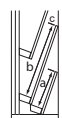

a = 110mm
b = 200mm
c = 25mm

Ridå Vägghängd

Välj rygg av följande material
RIVF = Filt ljusgrå eller antracit
RIVS = Spegel
RIVT = Trä
RIVW = Whiteboard

Ridå Wall model

Choose back of the following materials
RIVF = Felt in light gray or anthracite
RIVS = Mirror
RIVT = Wood
RIVW = Whiteboard



RIVF10
RIVS10
RIVT10
RIVW10
incl. 3 magnets

RIVF20
RIVS20
RIVT20
RIVW20
incl. 6 magnets

RIVF12
RIVS12
RIVT12
RIVW12
incl. 2 magnets

RIVF22
RIVS22
RIVT22
RIVW22
incl. 4 magnets

RIV14 RIV24

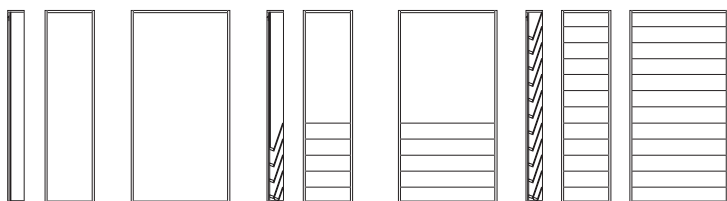

RIVF50
RIVS50
RIVT50
RIVW50
incl. 6 magnets

RIVF60
RIVS60
RIVT60
RIVW60
incl. 8 magnets

RIVF52
RIVS52
RIVT52
RIVW52
incl. 3 magnets

RIVF62
RIVS62
RIVT62
RIVW62
incl. 6 magnets

RIV54 RIV64

Tillbehör Accessories



RIA - Aluminium

Artno	Bredd Width mm	Djup Depth mm	Höjd Height mm	Filtack Felt pocket	Ridå SEK		Vikt netto Weight net kilos	Volym Volume net
					.10 ek oak .20 björk birch .50 lack color	Standardbets på ek Standard stain on oak Vitpigment ek White glazed oak		
RIVF10	371	124	742		6150	+600	10	0,06
RIVS10	371	124	742		5900	+590	10	0,06
RIVT10	371	124	742		5900	+590	10	0,06
RIVW10	371	124	742		6230	+610	10	0,06
RIVF20	742	124	742		7320	+740	15	0,12
RIVS20	742	124	742		6920	+700	15	0,12
RIVT20	742	124	742		6920	+700	15	0,12
RIVW20	742	124	742		7650	+770	15	0,12
RIVF12	371	124	742	ljusgrå light gray or anthracite	7120	+710	11	0,06
RIVS12	371	124	742	ljusgrå light gray or anthracite	6920	+700	11	0,06
RIVT12	371	124	742	ljusgrå light gray or anthracite	6810	+690	11	0,06
RIVW12	371	124	742	ljusgrå light gray or anthracite	7240	+730	11	0,06
RIVF22	742	124	742	ljusgrå light gray or anthracite	8770	+870	15	0,12
RIVS22	742	124	742	ljusgrå light gray or anthracite	8350	+830	15	0,12
RIVT22	742	124	742	ljusgrå light gray or anthracite	8350	+830	15	0,12
RIVW22	742	124	742	ljusgrå light gray or anthracite	9110	+890	15	0,12
RIV14	371	124	742	ljusgrå light gray or anthracite	7660	+770	11	0,06
RIV24	742	124	742	ljusgrå light gray or anthracite	9660	+980	15	0,12
RIVF50	371	124	1451		8340	+830	16	0,1
RIVS50	371	124	1451		8020	+800	16	0,1
RIVT50	371	124	1451		8020	+800	16	0,1
RIVW50	371	124	1451		8170	+820	16	0,1
RIVF60	742	124	1451		10290	+1020	25	0,22
RIVS60	742	124	1451		9760	+990	25	0,22
RIVT60	742	124	1451		9760	+990	25	0,22
RIVW60	742	124	1451		10820	+1080	25	0,22
RIVF52	371	124	1451	ljusgrå light gray or anthracite	10710	+1070	17	0,1
RIVS52	371	124	1451	ljusgrå light gray or anthracite	10350	+1030	17	0,1
RIVT52	371	124	1451	ljusgrå light gray or anthracite	10350	+1030	17	0,1
RIVW52	371	124	1451	ljusgrå light gray or anthracite	10590	+1070	17	0,1
RIVF62	742	124	1451	ljusgrå light gray or anthracite	13920	+1380	25	0,22
RIVS62	742	124	1451	ljusgrå light gray or anthracite	13400	+1350	25	0,22
RIVT62	742	124	1451	ljusgrå light gray or anthracite	13400	+1350	25	0,22
RIVW62	742	124	1451	ljusgrå light gray or anthracite	14480	+1450	25	0,22
RIV54	371	124	1451	ljusgrå light gray or anthracite	11690	+1150	17	0,1
RIV64	742	124	1451	ljusgrå light gray or anthracite	15070	+1510	25	0,22
RIA	70				90 aluminium			

SLOPE Skala Design 2013

Slope en exponeringshylla där olika höjder, bredder och tjocklekar av informationsmaterial och tidningar kan samsas.

Slope har bakåt lutande hyllplan, vilket ger en möjlighet att lägga upp tunt som tjockt material och olika höjder utan det viker sig eller faller framåt. Slope finns i fyra höjder och fyra bredder antingen endast med lutande hyllplan eller kombination med magnetisk whiteboard eller anslagstavla i Bulletin Board färg antracit nr 2209 eller klädd filt i färgerna ljusgrå, antracit och offwhite. Vid förfrågan klädd filt i tyg Comfort från Gabriel. Upphängningen är metallist på vägg.

Tillbehör: Elastiskt band i vit eller svart som håller papper på plats.

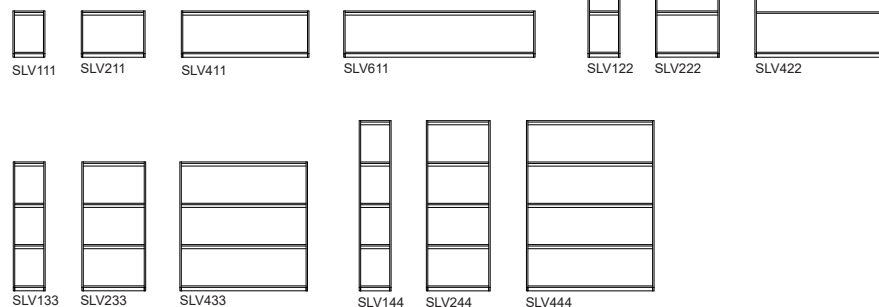
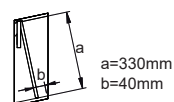

Välj ryggb av följande material
SLVB = Bulletin Board col. 2209
SLVW = Magnetisk whiteboard
SLVF = Filt i ljusgrå, antracit eller offwhite

Choose back of the following materials
SLVB = Bulletin Board col. 2209
SLVW = Magnetic Whiteboard
SLVF = Felt in lightgray, anthracite or offwhite

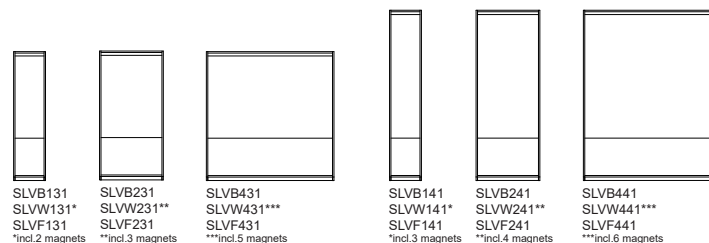

Tillbehör Accessories



Resärband vit eller svart
Elastic rope white or black

Slope a display shelf on which you can combine informative material and magazines of varying height, width and thickness. Slope's shelves lean backwards, which enable you to display both thin and thick materials of different heights without them folding over or falling forwards. Slope is available in four heights and four widths, either with sloping shelves only or combined with a magnetic whiteboard or noticeboard covered in Bulletin Board in anthracite grey (color number 2209) or felt in color light-grey, anthracite and offwhite.

Upon request covered felt in Comfort fabric from Gabriel. A metal rail is used to hang it on the wall. As an optional extra you can choose an elastic band in black or white that keeps papers, magazines, etc. in place.

Artno	Bredd Width mm	Djup Depth mm	Höjd Height mm	.10 ek oak .20 björk birch	.50 lack color	Standardbets på ek Standard stain on oak Vitpigment ek White glazed oak	Vikt netto Weight net kilos	Volym Volume
SLV111	270	143	392	3960	3130	+590	5	0,03
SLV211	540	143	392	4840	3730	+730	8	0,05
SLV411	1080	143	392	6310	4900	+960	12	0,1
SLV611	1620	143	392	8370	6220	+1270	14	0,15
SLV122	270	143	741	5290	4100	+800	8	0,05
SLV222	540	143	741	6760	5350	+1020	10	0,08
SLV422	1080	143	741	9170	7220	+1370	20	0,16
SLV133	270	143	1091	6730	5480	+1010	9	0,06
SLV233	540	143	1091	8770	7070	+1310	13	0,13
SLV433	1080	143	1091	12060	9510	+1810	23	0,25
SLV144	270	143	1440	8490	6840	+1280	10	0,08
SLV244	540	143	1440	10860	8590	+1640	16	0,15
SLV444	1080	143	1440	14900	11870	+2240	28	0,33
SLVB131	270	143	1091	6670	5520	+1000	8	0,06
SLVW131	270	143	1091	6800	5670	+1020	8	0,06
SLVF131	270	143	1091	6280	5180	+960	8	0,06
SLVB231	540	143	1091	8900	7460	+1330	13	0,13
SLVW231	540	143	1091	9190	7770	+1370	13	0,13
SLVF231	540	143	1091	8230	6760	+1240	13	0,13
SLVB431	1080	143	1091	12540	10540	+1880	23	0,2
SLVW431	1080	143	1091	13730	11730	+2070	23	0,2
SLVF431	1080	143	1091	11500	9470	+1730	23	0,2
SLVB141	270	143	1440	8240	6820	+1240	10	0,08
SLVW141	270	143	1440	8410	7000	+1270	10	0,08
SLVF141	270	143	1440	7900	6490	+1190	10	0,08
SLVB241	540	143	1440	10510	9030	+1570	16	0,15
SLVW241	540	143	1440	10980	9500	+1650	16	0,15
SLVF241	540	143	1440	9990	8540	+1510	16	0,15
SLVB441	1080	143	1440	15040	13160	+2260	28	0,33
SLVW441	1080	143	1440	16550	14670	+2490	28	0,33
SLVF441	1080	143	1440	14380	12500	+2150	28	0,33
Tillbehör Accessories				per styck each				
Resär vit eller svart. Elastic white or black	270			160				
Resär vit eller svart. Elastic white or black	540			170				
Resär vit eller svart. Elastic white or black	1080			190				
Resär vit eller svart. Elastic white or black	1620			250				

Ray finns i höjd 1600 mm, en rak modul i längd 630 mm och två svängda 30° moduler 800 och 1400mm och en med 45° modul med radie 385. Vissa kombinationer kräver en fot i pulverlackad metall för att uppnå hög stabilitet. Om modulerna ska förankras i golv var vänlig notera på underlag/beställning. Varje spalje är försedd med filtassar. Modulerna kommer monterade och hopkopplingen sker med dolda beslag.

Utförande är i massiv ek, ask, standardbetsar på ask och vitpigmenterad ek eller ask.

Ändavslut i metall, RAL 1019 Gray beige som standard till ek och ask samt RAL 9005 svart och RAL 9016 vit som tillval.

Med hjälp av handverktyg är de olika modulerna enkla att separera.

Vid beställning: ange artikelnummer, utförande och om modulerna ska förankras i golv.

Ray room divider is 1600 mm high. It comes as a straight module 630 mm long, and as two 30° modules with a radius of 800 and 1400 mm and one 45° with radius 385mm. For optimum stability certain combinations require a foot in powder-lacquered metal. If the modules are to be anchored to the floor, please note on the request / order. Each module is equipped with felt floor protectors. Modules are supplied assembled, ready to be linked with concealed link fittings. Ray comes in a choice of solid oak or ash, standard stains on ash and white glaze on oak or ash. End finish in metal, RAL 1019 Gray beige as standard for oak and ash and RAL 9005 black and RAL 9016 white as options.

Hand tools are all that is required to simply separate the different modules.

State when ordering: article number, finish and if the modules need to be anchored to the floor.

Artno

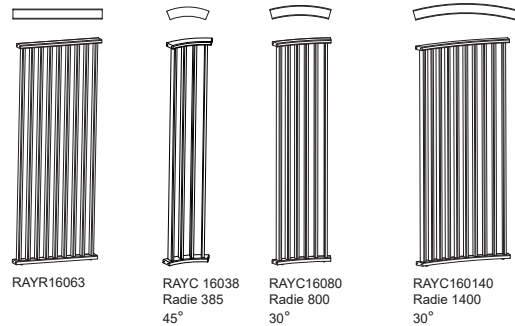

RAYFOTs svart black RAL 9005
RAYFOTv vit white RAL 9016
RAYFOTb gray beige RAL 1019

Ray SEK

Extra SEK

Artno		Bredd Width mm	Djup Depth mm	Höjd Height mm	Ray SEK		Extra SEK		
					.10 ek oak	.30 ask ash	Standardbets på ask Standard stain on ash Vitpigment ek, ask White glazed oak, ash	Vikt netto Weight net kilos	Volym Volume net
RAYR16063	Rak Straight	630	70	1600	7060	5800	+870	12	0,11
RAYC16038	Radie 385	320	70	1600	4190	3620	+540	6	0,11
RAYC16080	Radie 800	430	70	1600	5520	4610	+700	8	0,11
RAYC160140	Radie 1400	740	70	1600	7910	6440	+1200	14	0,2
Tillbehör Accessories									
RAYFOTs svart black RAYFOTv vit white RAYFOTb beige		370	60	4	330 / styck pc				
Håltagning 2st per fot Two holes per foot					140 / fot foot				

Förslag Suggestions

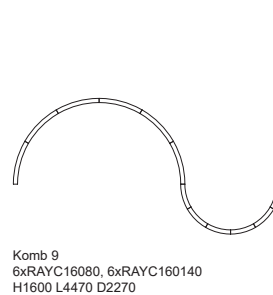
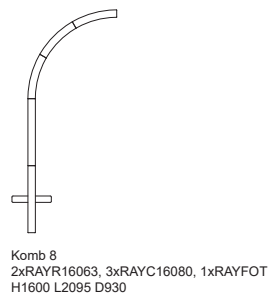
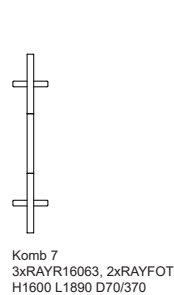
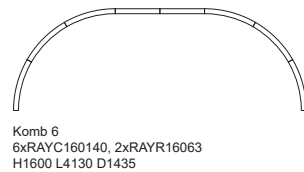
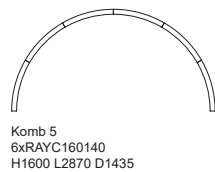
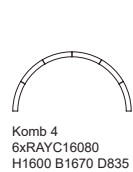
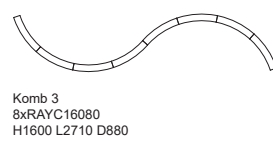
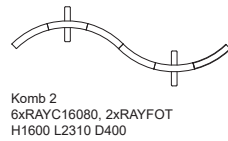
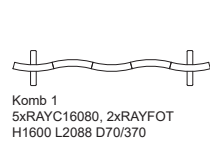

ONDULÉ SCREEN Anton Björnsing 2026

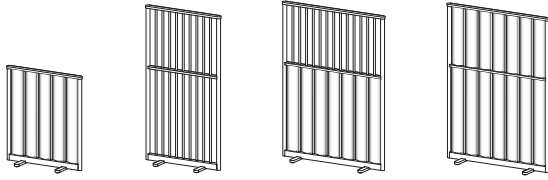

Ondulé Screen är en modulär skärmvägg med mycket tråkänsla. Den är omslutande med sin mjukt vågformade och klädda fasad och upplevs som luftig och ombonad på samma gång. Varje modul kan stå fristående som rumsavdelare eller kan de vara sammankopplade så att de skapar ett rum i rummet.

Ramen, rundstavarna och foten med filtass, är tillverkade i massiv ek, ask, standardbetser, vitpigmenterad ek eller ask. Ytbehandlingen är klarlack. Den vågformade fyllningen mellan rundstavarna är formpressad filt i färgerna antracit, ljusgrå och beige.

Den låga modellen finns i två varianter; transparent utan filt och helfyllt med filt.

Den högre modellen finns i tre varianter; helfyllt med filt, fylld nedtill och transparent upptill eller helt transparent med endast rundstavarna som avskärmning.

Kopplingsbeslaget skruvas undertill på ytterstolpen på förbestämd sida i förborrade hål med vilket man enkelt kan koppla ihop modulerna utan att några verktyg behövs.

Som tillbehör sinkade trälådor och hängs på modulerna med hjälp av svarta metallkonsoler i två olika längder. Dessutom finns en upphängningskrok för kläder eller väskor. De olika modulerna kommer monterade och är enkla att demontera när det är dags att fräscha upp dem.

Vid beställning ange artikelnummer, utförande på filt och trä.

Ondulé Screen is a modular room divider with a wooden touch. It is enveloping with its softly wavy and covered facade and is at the same time airy and cozy. Each module can stand alone or a lot can be connected to create a room within a room.

The frame, the rods and the foot with felt are made of solid oak, ash, standard stains, white pigmented oak or ash. The surface finish is clear lacquer. The wavy filling between the rods is molded felt in the colors anthracite, light gray and beige.

The low model is available in two versions; transparent without felt or filled with felt.

The higher model is available in three versions; fully filled with felt, filled at the bottom and transparent at the top or completely transparent with only the round rods as a screen.

The connection fitting is screwed to the bottom of the outer post on a predetermined side in pre-drilled holes with which you easily connect the modules without the need for any tools.

As accessories, there are two sizes of wooden box with dovetail joints for plants, bottles, pens or whatever you need to store. The boxes are hung on the modules using black metal brackets in two different lengths. There is also a hanging hook for clothes or bags.

The different modules come assembled and are easy to disassemble when it's time to freshen them up.

When ordering please state article number, finish on felt and wood.

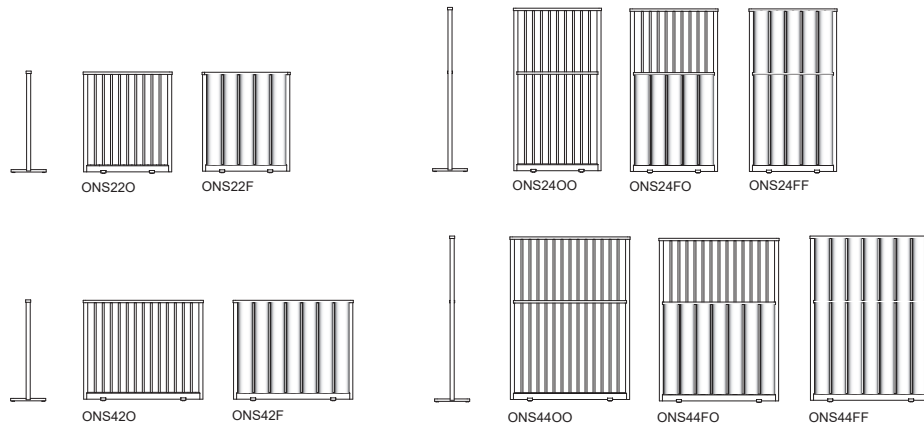

Tillbehör Accessories

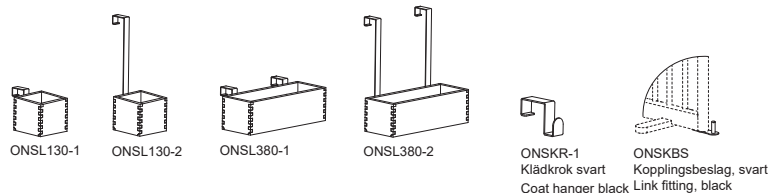

Artno	Filt -1 light gray -2 anthracite -3 beige	Bredd Width mm	Djup Depth mm	Höjd Height mm	Ondulé Screen SEK		Vikt netto Weight net kilos	Volym Volume net
					.10 ek oak .30 ask ash	Standardbets på ask Standard stain on ash Vitpigment ek, ask White glazed oak, ash		
ONS22O	----	915	360	1040	8150	+820	7	0,34
ONS22F	-1 light gray -2 anthracite -3 beige	915	360	1040	9630	+820	8	0,34
ONS24OO	----	915	360	1700	11770	+1180	11	0,56
ONS24FO	-1 light gray -2 anthracite -3 beige	915	360	1700	13260	+1180	12	0,56
ONS24FF	-1 light gray -2 anthracite -3 beige	915	360	1700	14670	+1180	12	0,56
ONS42O	----	1246	360	1040	9590	+960	9	0,47
ONS42F	-1 light gray -2 anthracite -3 beige	1246	360	1040	11070	+960	10	0,47
ONS44OO	----	1246	360	1700	14220	+1420	13	0,77
ONS44FO	-1 light gray -2 anthracite -3 beige	1246	360	1700	15710	+1420	14	0,77
ONS44FF	-1 light gray -2 anthracite -3 beige	1246	360	1700	17120	+1420	16	0,77
Tillbehör Accessories								
ONSL130-1	----	130/110	140/120	170/120	1460	+150	1	0,01
ONSL130-2	----	130/110	140/120	400/120	1480	+150	1	0,01
ONSL380-1	----	380/360	140/120	170/120	2170	+220	3	0,01
ONSL380-2	----	380/360	140/120	400/120	2210	+220	3	0,01
ONSKR-1	----	25	79	58	190 svart / black		0,5	
ONSKBS	----				430 svart / black		1	

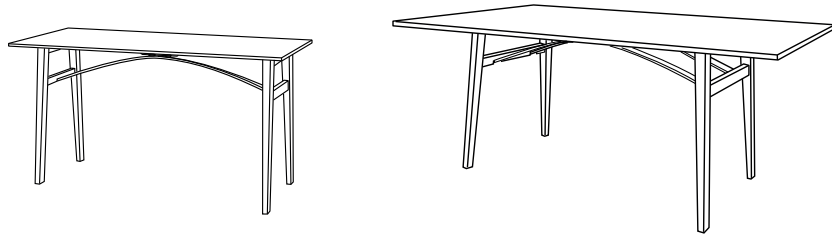

Fällbart bord.

Bordsskiva av trälamell med faner, tjocklek ca 23mm, i ek, ask, björk, standardbetsler på ask och vitpigmenterad ek och ask. Alternativt högtryckslaminat ek, björk, ask, vit och svart matt samt svart desktop. Ben i massivt trä av ek, ask, björk, standardbetsler på ask och vitpigmenterad ek och ask. Ytbehandling klarlack. Specialmått och andra utförande efter förfrågan. Bordet levereras monterat.

Folding table.

The table top made from blockboard finished, thickness approx. 23mm, in natural oak, ash, birch veneer, standard stains on ash and white glaze on oak and ash. High Pressure Laminate of oak, birch, ash, white laminate, black matte laminate and black desktop. Legs in solid wood of oak, ash, birch, standard stains on ash and white glazed on oak and ash. Finish clear lacquer. Special sizes and other finishes upon request. The table comes pre-assembled.

Artno

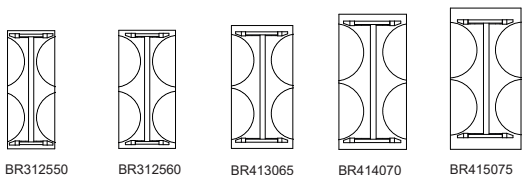

BR312550 BR312560 BR413065 BR414070 BR415075

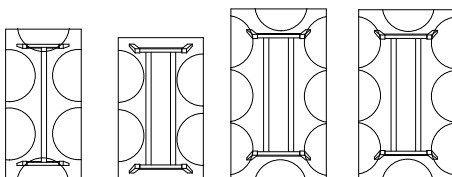

BR416080 BR515090 BR518090 BR5180100

Tillbehör Accessories

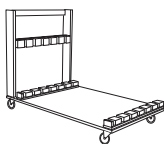

BRV7
Vagn. Plats för 8 bord. Björk
Trolley. For 8 tables. Birch

Artno	Längd Length mm	Bredd Width mm	Höjd Height mm	Brygga SEK				Extra SEK		Avstånd mellan ben Distance between legs	Vikt netto Weight net kilos	Volym Volume net
				Top Faneer Veneer Ben Legs .10 ek oak .20 björk birch .30 ask ash	Top Vit White laminate Ben Legs .61 ek oak .62 björk birch .63 ask ash	Top Svart matt Black Laminate Ben Legs .65 ek oak .66 björk birch .67 ask ash	Top Svart Black Desktop Ben Legs .91 ek oak .92 björk birch .93 ask ash	Standardbets på ask på skiva+ben Standard stain on ash on top+legs	Vitpigment ek ask White glazed oak ash			
BR3 12550	1250	500	720	13320	13540	14270	13340	+2150	1080	16	0,12	
BR3 12560	1250	600	720	14390	14590	15410	15030	+2380	1080	18	0,15	
BR4 13065	1300	650	720	14960	15150	16020	15640	+2410	1080	25	0,15	
BR4 14070	1400	700	720	16040	16260	17190	16820	+2510	1080	27	0,16	
BR4 15075	1500	750	720	16170	16430	17350	17130	+2640	1200	29	0,21	
BR4 16080	1600	800	720	17280	17540	18450	18290	+2880	1200	34	0,25	
BR5 15090	1500	900	720	19360	19590	20790	20310	+3200	1200	31	0,25	
BR5 18090	1800	900	720	20520	20800	21960	21540	+3400	1200	45	0,30	
BR5 180100	1800	1000	720	21750	22150	21900	22970	+3580	1200	50	0,31	
				Tillbehör SEK Accessories								
BRV7 vagn trolley	1250	760	950	14750 björk birch							35	1,0

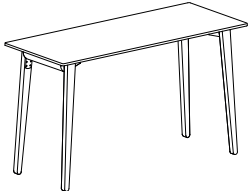

Träben Legs of wood



Stålben Legs of steel

Fällbord

SKIVA

träfanerad MDF i ek, björk, ask, standardbets på ask, vitpigmentrad ek och ask. Ybehandling klarlack.

Vit laminat NCS S0502-G50Y.

Svart laminat Fenix NTM 0720 Nero Ingo, S8500-N

Svart desktop nr 4023 nero, NCS S9000-N.

Högtryckslaminat ek nr F5374 NAT, björk nr F7555 MAT, ask nr F8843 NAT. (PR3140 finns ej i ek, björk, ask laminat)

Tjocklek: Rektangulär skiva 13mm. Rund skiva 17mm.

KANTLIST

Massiv trä ek, ask eller björk.

Standardbets på ask, endast på träfanerad skiva i samma färg.

Vit eller svart, ABS.

BEN

Ihopfallda höjd 85mm.

Träben i massiv ek, björk, ask, standardbets på ask och vitpigmentrad ek och ask. Ybehandling klarlack.

Stålben i blankkrom, cr3+.

Stålben i pulverlack med finstruktur i svart RAL9005 eller grå RAL9006/07.

Filtass på samtliga bord.

Vid behov av större avstånd mellan långsidans ben vänligen kontakta info@karl-andersson.se

STAPLINGS- OCH KLÄMSKYDD

Filt färg antracit som standard.

Som tillval och ska noteras på order ljusgrå eller offwhite filt.

TILLBEHÖR

Ljudabsorbent under bordsskiva, kan ej kombineras med eluttag.

Bordspanel antracit filt som hängs på krokar. Eller som tillval ljusgrå eller offwhite filt.

Kopplingsbeslag för kortsida och vissa storlekar för långsida.

Två hjul, ej läsbara vilket ger något ökad rörlighet mot golvet (endast för träben).

Eluttag. Anslutningskabel 5 meter, med jordad Schucko stickpropp och vidarekopplingskabel 3 meter, för seriekoppling mellan bord.

Förvaringsvagn med handtag i metall kan placeras på kortsida (plats för 13 bord) eller långsidan (plats för 7 bord), läsbara hjul. För bord med längd 1600 mm och längre rekommenderas att de transporteras liggande varför handtaget ska monteras på vagnens långsida.

ÖVRIGT

Tjockfanér på bordsskiva 1,5mm mot pristillägg se sid 3.

Specialmått och andra utförande efter förfrågan.

Bordet levereras monterat.

VID ORDER ANGE

Artikelnummer, på bord och tillbehör. Utförande på skiva, kantlist, ben och färg på staplings- och klämskydd.

Folding table

TOP

Wooden top veneered on MDF in oak, birch, ash, standard stain on ash, white glazed on oak or ash. Finish clear lacquer.

White laminate NCS S0502-G50Y.

Black laminate Fenix NTM 0720 Nero Ingo, S8500-N

Black desktop no 4023 nero, NCS S9000-N.

High Pressure Laminate oak no F5374 NAT, birch no F7555 MAT, ash no F8843 NAT. (PR3140 not available in HPL)

Thickness: Rectangulare top 13mm. Round top 17mm.

EDGE

Solid wood in oak, birch, ash.

Standard stain on ash, only on wooden top in same color.

White or black ABS.

LEGS

Folding height 85mm.

Solid wood in oak, birch, ash, standard stain on ash, white glazed on oak or ash. Finish clear lacquer.

Steel in finish polished chrome, cr3+.

Steel in finish powder coating with fine texture in black RAL9005 or gray RAL9006/07.

All tables have felt floor protection.

If you need a greater distance between the legs of the long side, please contact info@karl-andersson.se

STACKING- / SAFTEY COVER

Felt in color anthracite as standard.

As option color and state when ordering light gray or offwhite felt.

ACCESSORIES

Sound-absorbent panel for concealed installation under the tabletop, which cannot be combined with electrical outlets.

Modesty panel in antrachite felt which hangs on hooks, or lightgray or offwhite.

Two wheels which are note lockable, giving slightly mobility to the floor, (only for wooden legs).

Link fittings short side to short side. Some tables even for long side.

Power outlet. Start cable 5metres, with saftey plug, Schuko and cable to connect 3metres, with other tables.

Storage trolley with locking wheels and a metal handle, placed either on the short end (for 13 tables) or the long side (7 tables).

For tables with a length 1600mm or longer we recommend that they are transported horizontally, which means that the handle is to be mounted on the trolley's long side.

MORE INFORMATION

Thick veneer on tabletop 1.5 mm, available at an additional cost – see page 3.

Special sizes and other finishes upon request.

The table comes pre-assembled.

STATE WHEN ORDERING

Article number for table and accessories. Execution on table top, edge, legs and color of stacking- / saftey cover.

Artno

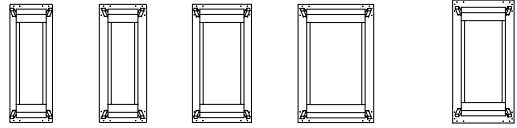

PR112545 PR112550 PR112562 PR112580 PR113065

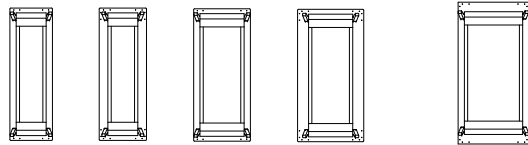

PR114045 PR114050 PR114060 PR114070 PR115075

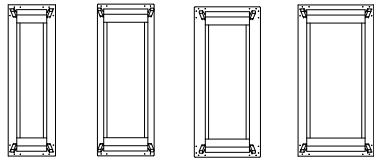

PR116050 PR116060 PR116070 PR116080

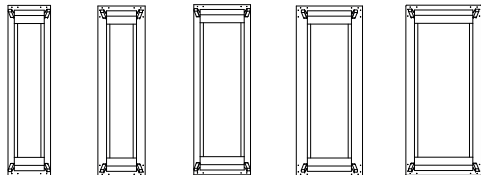

PR118045 PR118050 PR118060 PR118070 PR118080

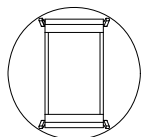

PR3140*
*finns ej i laminat ek, björk, ask
*not in laminate oak, birch, ash

Tillbehör Accessories	Artno	Mått Dimension mm		SEK
	PRK		Kopplingsbeslag. Alla bord kan kopplas kortsida mot kortsida. Följande bord kan kopplas längsida mot längsida. PR1 12550, PR1 13065, PR1 14050, PR1 14070, PR1 16080, PR1 18050, PR1 18070, PR1 18080. Observera! priset är baserat på koppling kortsida mot kortsida alternativt längsida mot längsida. Link fittings. All tables can be connected short side to short side. The following table can be connected long side to long side. PR1 12550, PR1 13065, PR1 14050, PR1 14070, PR1 16080, PR1 18050, PR1 18070, PR1 18080. Note!! The price is for link fittings short side to short side or long side to long side.	850
	PRH		Hjul endast till träben. Monterat på två bordssben, grå. Ej låsbara vilket ger något ökad rörlighet mot golvet. Castors only to the wooden legs. Placed on two legs, grey. Not lockable, giving slightly mobility to the floor.	450 / 2pcs
	TKB7P	ø115	Twist. Lock borstat rostfritt stål. 2 eluttag 220V. 2 kabelhållare exkl kablar. Gäller för SE,NO,FIN,DE,NL Twist. Brushed stainless steel. 2 Electrical outlets 220V. 2 cable holders excl. cables. For SE,NO,FIN,DE,NL	3760
	TKB11P	ø57	Powerdot Mini. 1 eluttag, svart, 2 kabelhållare exkl kablar. Gäller för SE,NO,FIN,DE,NL. Powerdot Mini. 1 electrical black, 2 cable holders excl. cables. For SE,NO,FIN,DE,NL	1590
	TKB19P	ø57	Powerdot Mini. USB C laddare inkl. 2 portar, svart. Kabelhållare exkl kablar. Gäller för SE,NO,FIN,DE,NL. Powerdot Mini. USB C charging 2 ports, black. 2 cable holders excl. cables. For SE,NO,FIN,DE,NL	2290
	TKB20P	ø70	Powerdot Midi. 1 eluttag, 1 USB C laddare, svart. Kabelhållare exkl kablar. Gäller för SE,NO,FIN,DE,NL. Powerdot Midi. 1 electrical, 1 USB C charging, black. 2 cable holders excl. cables. For SE,NO,FIN,DE,NL	2290
	TKB9P	L 155 W 63	Kabelgenomföring. Lock i borstat rostfritt stål. 3 jordade eluttag på undersidan av bordsskivan. 2 kabelhållare, exkl kablar. Gäller för SE,NO,FIN,DE,NL, andra länder mot offert. Cable slot. Brushed stainless steel lid. 3 electrical outlets placed under the table top. 2 cable holders, excl. cables. For SE,NO,FIN,DE,NL other countries upon request	1780
	PRCA5	L 5000	Anslutningskabel. 5 meter med jordad Schuko stickpropp Start cable. 5 meters with safety Schuko plug	570
	PRCV3	L 3000	Vidarekopplingskabel. 3 meter, för seriekoppling mellan bord. Connecting cable 3 meters between tables.	430
	PRV	L 1210 W 700 H 1057	Vagn. Låsbara hjul. Handtag kan monteras på lång- eller kortsida. För bord med längd 1600 mm och längre rekommenderas att borden transporteras liggande, varför handtaget ska monteras på vagnens längsida. Plats antal bord, handtag kortsida 13st. Plats antal bord, handtag längsida 7st. Trolley. Lockable castors. Handle mounted on long- or shortside. For tables with a length 1600 mm and longer, we recommend that they are transported horizontally, which means that the handle is to be mounted on the trolley's long side. Numbers of table, 13pcs handle on shortside. Numbers of table, 7pcs handle on longside. 16kg 1,0kkm³	8560

Artno	Längd Length mm	Bredd Width mm	Diam. mm	Höjd Height mm	Press SEK				Extra SEK				Avdrag Reduction				
					Top faneer veneer Ben Legs .10 ek oak .20 björk birch .30 ask ash	Top Vit White Laminate Ben Legs .61 ek oak .62 björk birch .63 ask ash	Top Svart Black Laminate Ben Legs .65 ek oak .66 björk birch .67 ask ash	Top Svart Black Desktop Ben Legs .91 ek oak .92 björk birch .93 ask ash	Standardbets på ask skiva+ben Standard stain on ash top+legs	Standardbets på ask skiva Standard stain on ash top	Standardbets på ask ben Standard stain on ash legs	Tjockfaner 1,5mm pristillägg och information se sid 3	Höjd Height 900mm	Bordspanel filt H280mm Modesty panel felt H280mm	Ljudabsorbent Sound absorber	Stälben blankkrom Steel legs polished chrome	Stälben pulverlack svart eller grå Steel legs powder coating black or gray
PR112545	1250	450		725	10340	10560	11300	10920	+1570	+460	+1100			+1130	+550	+530	/.620
PR112550	1250	500		725	10460	10660	11390	11030	+1570	+460	+1100			+1130	+550	+530	/.620
PR112562	1250	625		725	10940	11150	11960	11610	+1650	+550	+1100			+1130	+800	+530	/.620
PR112580	1250	800		725	12200	12430	13230	12850	+1840	+550	+1240			+1130	+800	+530	/.620
PR113065	1300	650		725	11380	11600	12520	12080	+1680	+560	+1130			+1190	+800	+530	/.620
PR114045	1400	450		725	10900	11110	11980	11640	+1640	+470	+1140			+1360	+550	+530	/.620
PR114050	1400	500		725	10980	11180	12040	11720	+1650	+500	+1140			+1360	+550	+530	/.620
PR114060	1400	600		725	11470	11690	12590	12230	+1730	+560	+1140			+1360	+800	+530	/.620
PR114070	1400	700		725	11630	11860	12780	12420	+1780	+600	+1140			+1360	+800	+530	/.620
PR115075	1500	750		725	13160	13410	14320	14110	+1980	+690	+1300			+1380	+800	+530	/.620
PR116050	1600	500		725	11870	12080	12970	12800	+1960	+630	+1310		+660	+1400	+750	+530	/.620
PR116060	1600	600		725	12370	12590	13510	13330	+1960	+630	+1310		+660	+1400	+1130	+530	/.620
PR116070	1600	700		725	12690	12920	13810	13640	+1960	+630	+1310		+660	+1400	+1130	+530	/.620
PR116080	1600	800		725	13440	13700	14590	14440	+2010	+700	+1310			+1400	+1130	+530	/.620
PR118045	1800	450		725	12000	12210	13120	12950	+1810	+600	+1190		+660	+1450	+740	+530	/.620
PR118050	1800	500		725	12160	12370	13250	13090	+1840	+610	+1190		+660	+1450	+740	+530	/.620
PR118060	1800	600		725	12640	12850	13880	13600	+1890	+630	+1270		+660	+1450	+1130	+530	/.620
PR118070	1800	700		725	12850	13070	14090	13820	+1930	+660	+1270		+660	+1450	+1130	+530	/.620
PR118080	1800	800		725	13730	13980	15110	14730	+2080	+740	+1360			+1450	+1130	+530	/.620
PR3140*			ø1400	730	14130	14330	15410	15170	+1840	+580	+1260				+800	+530	/.620

*finns ej i laminat ek, björk, ask
*not in laminate oak, birch, ash

Information

Artno	Vikt netto Träben Weight net Wooden legs For metal legs add +0,6kilo	Volym Volume net	Ihopfällt Folding mm	*Avstånd ben långsida avser sitthöjd 450mm *Distance legs long side, refers to seat height 450mm mm	Avstånd ben kortsida avser sitthöjd 450mm Distance legs short side, refers to seat height 450mm mm	Kopplingsbart kort sida Connected short side	Kopplingsbart långsida Connected long side
PR112545	13	0,09	85	1027	343	YES	----
PR112550	13,5	0,09	85	1027	343	YES	YES
PR112562	15	0,11	85	1027	493	YES	----
PR112580	16	0,14	85	1027	643	YES	----
PR113065	16	0,11	85	1027	493	YES	YES
PR114045	14	0,12	85	1177	343	YES	----
PR114050	14,5	0,12	85	1177	343	YES	YES
PR114060	16	0,13	85	1177	493	YES	----
PR114070	17	0,14	85	1177	493	YES	YES
PR115075	19	0,15	85	1177	643	YES	----
PR116050	17	0,13	85	1377	343	YES	YES
PR116060	17,5	0,14	85	1377	493	YES	----
PR116070	19	0,15	85	1377	493	YES	YES
PR116080	21	0,17	85	1377	643	YES	YES
PR118045	15,5	0,13	85	1577	343	YES	----
PR118050	16,5	0,13	85	1577	343	YES	YES
PR118060	20	0,16	85	1577	493	YES	----
PR118070	20,5	0,18	85	1577	493	YES	YES
PR118080	22	0,20	85	1577	643	YES	YES
PR3140	31	0,20	85	1027	643	----	----

*Vid behov av större avstånd mellan långsidans ben vänligen kontakta info@karl-andersson.se

*If you need a greater distance between the legs of the long side, please contact info@karl-andersson.se

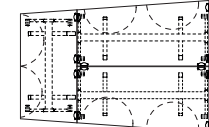
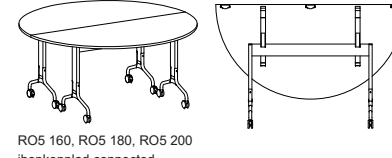
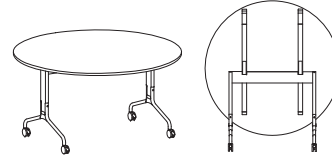

Exempel ihopkoppling av trapetsbord
Example of connecting a trapezoidal table

Fällbord.

Rollo fälls med ett fjäderande tvåhandsgrepp som gör att bordet är enkelt att fälla och ger maximalt utrymme för karmstolar men som också säkerställer att skivan inte fälls upp av misstag. Bordsskivan är balanserad så att den fällda skivan alltid står i rakt uppfällt läge. Bord med uppfälld skiva kan sättas ihop och staplas sidledes i varandra. Bordsskivan, tjockleck ca 20mm, är i fänerad MDF av ek, ask, björk, standardbetser på ask, vitpigmenterad ek eller ask. Alternativt högtryckslaminat (vit, svart, ek, björk, ask) och svart desktop. Balk och gavel är i massivt trä, utförande lika bordsskivan. Kantlistens utföranden, på bordsskivan är rak och följer balk och gavel. Benavslut av metall med ytbehandling av pulverlackad finstruktur i vit (RAL 9016), svart (RAL 9005) alternativt grå (RAL9006/07). Borden är försedda med fyra svarta låsbara hjul.

Tillval till rektangulära bord är kopplingsbeslag, vilket rekommenderas när borden ska placeras i rad, bordsfront i svart eller vit kompaktlaminat. När bord är försedda med eluttag fälls och ställs undan förvaras kablarna i balken som är monterad under bordsskivan. Bordet levereras omöblerat. Bengaviarna monteras på bordsbalken. Vid behov kan samtliga delar demonteras med enkla handverktyg. Specialmått och andra utförande efter förfrågan

Folding table.

A spring-loaded construction ensures that Rollo opens easily with a two-handed grip, providing the maximum space for chairs with arms while also ensuring that the table cannot fold up accidentally. The tabletop is carefully balanced so that it is always perfectly level when unfolded. When folded, tables can be placed close together and stacked side by side.

The tabletop, thickness approx.23mm, is made of veneered MDF, finished in oak, ash, birch, standard stains on ash, white glaze on oak or ash. The table top is also available in High Pressure Laminate (white, black, oak, ash, birch) or black desktop. The centre beam and ends are of solid wood in the same finish as the top. The edge of table top is straight and finish is the same as the centre beam and ends. Table legs terminate in a metal foot with a finely textured powder lacquer finish in white (RAL 9016), black (RAL 9005) or grey (RAL9006/07). Each table is fitted with four black wheels that can be locked in place.

As an option for the rectangular table, link fittings are recommended when the tables are to be placed in a row, modesty panel in black or white compact laminate. Tables equipped with electric outlets have cable ducts with a wooden finish, so cables can be kept in place under the tabletop when the table is folded for storage. The table is supplied unassembled. The leg frames are to be fitted to the central beam. If required, the table can be easily dismantled into its component parts using only simple hand tools. Please enquire for details of non-standard sizes and other finishes

Artno

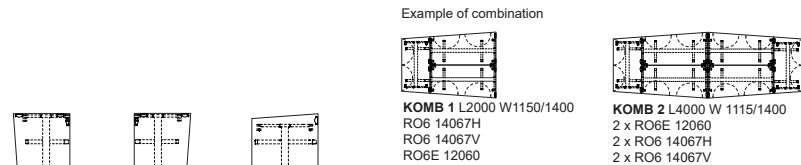
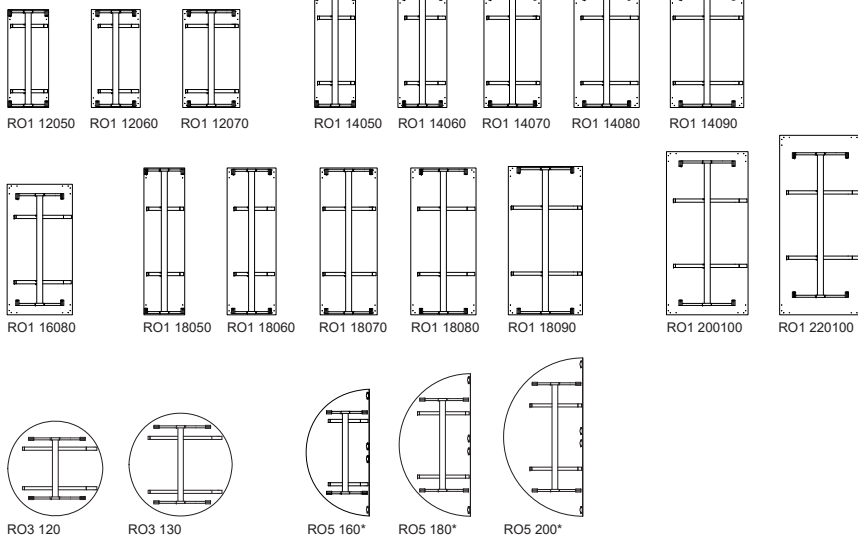

RO6 14056V**
RO6 14067V**
RO6 14078V**

RO6 14056H**
RO6 14067H**
RO6 14078H**

RO6E 10050*
RO6E 12060*
RO6E 14070*

KOMB 3 L5600 W 1000/1400
2 x RO6 14056H
2 x RO6 14056V
2 x RO6 14067H
2 x RO6 14067V

*inkl. 4st kopplingsbeslag
*inkl. 4pcs link fittings

**inkl. 6st kopplingsbeslag
**inkl. 6pcs link fittings

Tillbehör Accessories	Artno	Dimension mm		SEK
	TKB7R	ø115	Twist. Lock borstat rostfritt stål. 2 Eluttag. 2m kabel. Gäller för SE, NO, FIN, DE, NL. Twist. Brushed stainless lid. 2 Electrical. 2m cables. For SE,NO,FIN,DE,NL.	3120
	TKB11R	ø57	Powerdot Mini. 1 eluttag, svart, 1,5m kabel. Gäller för SE,NO,FIN,DE,NL. Powerdot Mini. 1electrical black, 1,5m cable. For SE,NO,FIN,DE,NL	1140
	TKB19R	ø57	Powerdot Midi. USB C laddare inkl. 2 portar, svart. 1,25m kabel. Gäller för SE,NO,FIN,DE,NL. Powerdot Midi. USB C charging 2 ports, black. 1,25m cable. For SE,NO,FIN,DE,NL	1870
	TKB20R	ø70	Powerdot Midi. 1 eluttag, 1 USB C laddare, svart. 1,25m kabel. Gäller för SE,NO,FIN,DE,NL. Powerdot Midi. 1 electrical, 1 USB C charging, black. 1,25m cable. For SE,NO,FIN,DE,NL	1870
	ROK		Kopplingsbeslag. Rektangulära bord kan kopplas på kort- och långsida. Observera! priset är baserat på koppling kortsida mot kortsida alternativt långsida mot långsida. Link fittings. Rectangulare tables can be connected short side to shor side or longside to longside. Note! The price is for link fittings short side to short side or long side to long side.	850
	ROFRP	L1200 L1400 L1600 L1800 L2000 L2200	Bordspanel. Endast i svart eller vit kompaktlaminat. Upphängningskrok svart. Modesty panel. Only in black or white compact laminate Hook in black.	pris sid. 42 price page 42

Artno	Längd Length mm	Bredd Width mm	Höjd Height mm	Diam mm	Rollo SEK				Extra SEK						
					Top faneer veneer Ben Legs .10 ek oak .20 björk birch .30 ask ash	Top Vit White Laminate Ben Legs .61 ek oak .62 björk birch .63 ask ash	Top Svart Black Laminate Ben Legs .65 ek oak .66 björk birch .67 ask ash Top Laminate Ben Legs .71 ek oak .72 björk birch .73 ask ash	Top Svart Black Desktop Ben Legs .91 ek oak .92 björk birch .93 ask ash	Standardbets på ask skiva Standard stain on ash top Vitpigment White glazed	Standardbets på ask ben Standard stain on ash legs Vitpigment White glazed	Tjockfaner 1,5mm pristillägg och information se sid 3 Thick veneer on tabletop 1.5 mm, available at an additional cost – see page 3.	Höjd Height 900mm	Bordspanel svart eller vit kompakt- laminat Modesty panel black or white compact laminate H300	Vikt netto Weight net kilos	Volym Volume net
RO1 12050	1200	500	730		12690	12890	13590	13250	+270	+580		+360	+1270	19	0,15
RO1 12060	1200	600	730		12890	13070	13860	13520	+290	+580		+360	+1270	22	0,17
RO1 12070	1200	700	730		13540	13740	14550	14160	+340	+580		+360	+1270	25	0,2
RO1 14050	1400	500	730		13630	13750	14600	14360	+330	+630		+360	+1330	22	0,16
RO1 14060	1400	600	730		13840	14050	14860	14590	+340	+630		+360	+1330	25	0,2
RO1 14070	1400	700	730		14550	14760	15660	15290	+380	+630		+360	+1330	28	0,22
RO1 14080	1400	800	730		14760	14980	15880	15500	+400	+630		+360	+1330	32	0,23
RO1 14090	1400	900	730		17380	17600	18510	18120	+440	+630		+360	+1330	36	0,23
RO1 16080	1600	800	730		17140	17390	18370	18040	+630	+630		+360	+1410	31	0,25
RO1 18050	1800	500	730		17330	17570	18410	18170	+570	+730		+360	+1590	28	0,2
RO1 18060	1800	600	730		17600	17850	18690	18550	+590	+730		+360	+1590	32	0,22
RO1 18070	1800	700	730		18410	18670	19550	19470	+640	+730		+360	+1590	36	0,25
RO1 18080	1800	800	730		18710	18980	19940	19880	+690	+730		+360	+1590	40	0,28
RO1 18090	1800	900	730		21440	21730	22710	22650	+730	+730		+360	+1590	44	0,33
RO1 200100	2000	1000	730		22930	23260	24400	24230	+870	+730		+360	+1670	45	0,4
RO1 220100	2200	1000	730		23280	23630	24780	24560	+890	+730		+360	+1740	55	0,41
RO3 120			730	1200	17790	18000	18900	18430	+580	+570		+360	----	27	0,17
RO3 130			730	1300	18710	18920	19880	19410	+640	+570		+360	----	33	0,22
RO5 160	1600	800	730		17200	17450	18420	18120	+660	+580		+360	----	31	0,25
RO5 180	1800	900	730		18980	19270	20250	20190	+790	+590		+360	----	44	0,4
RO5 200	2000	1000	730		21050	21390	22520	22340	+940	+640		+360	----	45	0,41
RO6 14056V	1400	500/600	730		14870	15070	15880	15620	+340	+630		+360	+1330	22	0,16
RO6 14067V	1400	600/700	730		15570	15780	16680	16300	+380	+630		+360	+1330	25	0,2
RO6 14078V	1400	700/800	730		15780	16010	16890	16520	+400	+630		+360	+1330	28	0,22
RO6 14056H	1400	500/600	730		14870	15070	15880	15620	+340	+630		+360	+1330	22	0,16
RO6 14067H	1400	600/700	730		15570	15780	16680	16300	+380	+630		+360	+1330	25	0,2
RO6 14078H	1400	700/800	730		15780	16010	16890	16520	+400	+630		+360	+1330	48	0,22
RO6E 10050	930/1000	500	730		13360	13560	14280	13940	+270	+580		+360	----	19	0,15
RO6E 12060	1115/1200	600	730		13560	13760	14540	14190	+290	+580		+360	----	22	0,17
RO6E 14070	1300/1400	700	730		15230	15430	16340	15960	+380	+630		+360	----	28	0,22

Information

Artno	H = Höjd/ A = Uppfälld skiva	H = Höjd/ A = Uppfälld skiva	B	C	U		X
	H = Height/ A = Table top raised mm	H = Height/ A = Table top raised mm			Avstånd från golv till under- kant bordsskiva		
	H730	H900			H730	H900	
RO1 12050	730/995	900/1070	1120	475	710	880	540
RO1 12060	730/1045	900/1215	1120	475	710	880	540
RO1 12070	730/1095	900/1265	1120	575	710	880	640
RO1 14050	730/995	900/1070	1320	475	710	880	540
RO1 14060	730/1045	900/1215	1320	475	710	880	540
RO1 14070	730/1095	900/1265	1320	575	710	880	640
RO1 14080	730/1145	900/1315	1320	575	710	880	640
RO1 14090	730/1195	900/1365	1320	675	710	880	740
RO1 16080	730/1145	900/1315	1320	575	710	880	640
RO1 18050	730/995	900/1070	1720	475	710	880	540
RO1 18060	730/1045	900/1215	1720	475	710	880	540
RO1 18070	730/1095	900/1265	1720	575	710	880	640
RO1 18080	730/1145	900/1315	1720	575	710	880	640
RO1 18090	730/1195	900/1365	1720	675	710	880	740
RO1 200100	730/1245	900/1415	1720	675	710	880	740
RO1 220100	730/1245	900/1415	1720	675	710	880	740
RO3 120	730/1345	900/1515	740	675	710	880	740
RO3 130	730/1395	900/1565	920	675	710	880	740
RO5 160	730/1045	900/1215	920	475	710	880	540
RO5 180	730/1095	900/1265	1120	575	710	880	640
RO5 200	730/1095	900/1265	1320	575	710	880	640
RO6 14056V	730/1045	900/1215	1320	475	710	880	540
RO6 14067V	730/1095	900/1265	1320	475	710	880	540
RO6 14078V	730/1145	900/1265	1320	575	710	880	640
RO6 14056H	730/1045	900/1215	1320	475	710	880	540
RO6 14067H	730/1095	900/1265	1320	475	710	880	540
RO6 14078H	730/1145	900/1265	1320	575	710	880	640
RO6E 10050	730/995	900/1070	740	475	710	880	540
RO6E 12060	730/1045	900/1215	920	475	710	880	540
RO6E 14070	730/1095	900/1265	1120	575	710	880	640

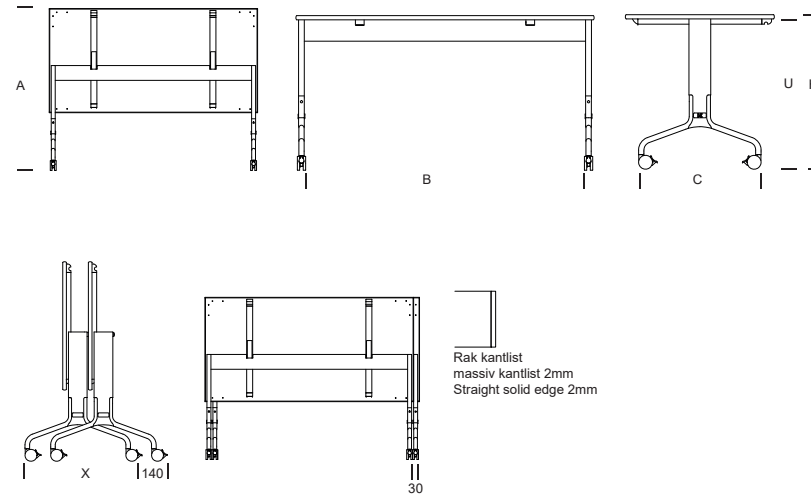



Fällbord.

Peel har en fällmekanism i svart som är monterad under bordsskiva. Ett handtag är placerat i mekanismen som man enkelt drar ut för att fälla bordsskivan. Bordsskivan finns som standard i fanerad MDF i ek, ask, standardbets, vitpigmenterad ek och ask. Laminat (vit, svart, ek, ask) och svart desktop. Skiva finns i massiv trä mot tillägg. Pelare är försedd med stälkärna och fot i massiv trä och försedd med filltass och finns i ek, ask, standardbets och vitpigmenterad ek och ask. Borden förvaras uppställda med nedfäld skiva och pelarfoten förs samman med varandra. För andra utförande efter förfrågan. Peel levereras monterat. Vid behov kan bordsskiva, fällmekanism och pelare enkelt demonteras med enkla handverktyg. Vid order var vänlig ange artikelnummer, höjd och utförande.

Folding table.

Peel has a folding mechanism in black which is mounted under the table top. A handle is placed in the mechanism which is easily pulled out to fold the table top. The table top is available as standard in veneered MDF in oak, ash, standard stains, white-pigmented oak and ash. Laminate (white, black, oak, ash) and black desktop. Top available in solid wood for an additional charge. Pillar is provided with a steel core and foot in solid wood and provided with a felt foot and is available in oak, ash, standard stains and white-pigmented oak and ash. The tables are stored upright with the top folded down and the column base is brought together. For other options upon request. Peel is delivered assembled. If necessary, the table top, folding mechanism and pillars can be easily dismantled with simple hand tools. When ordering, please state the article number, height and design.

Artno

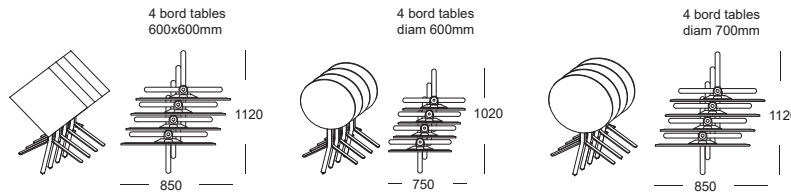
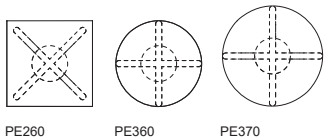

Artno	Längd Length mm	Bredd Width mm	Höjd Height mm	Diam mm	Peel SEK				Extra SEK				Vikt netto Weight net kilos	Volym Volume net
					Top faneer veneer Ben Legs .10 ek oak .30 ask ash	Top Vit White Laminate Ben Legs .61 ek oak .63 ask ash	Top Svart Black Laminate Ben Legs .65 ek oak .67 ask ash	Top Svart Black Desktop Ben Legs .91 ek oak .93 ask ash	Standardbets på ask skiva Standard stain on ash top	Standardbets på ask ben Standard stain on ash legs	Tjockfaner 1,5mm pristillägg och in- formation se sid 3	Massiv skiva Solid table top		
Kvadratisk Square														
PE260*	600	600	550		9190	9270	9740	9480	+530	+920		+1350	10	0,23
PE260	600	600	730		9930	10000	10480	10220	+530	+1000		+1350	10	0,3
PE260	600	600	900,1050		10620	10700	11170	10910	+530	+1060		+1350	11/11	0,36/0,4
Rund Round														
PE360			550	600	9190	9270	9740	9480	+530	+920		+1350	8	0,23
PE360			730	600	9930	10000	10480	10220	+530	+1000		+1350	9	0,3
PE360			900,1050	600	10620	10700	11170	10910	+530	+1060		+1350	9/10	0,36/0,43
PE370			550	700	9450	9570	10290	9850	+540	+940		+1350	9	0,3
PE370			730	700	10190	10310	11020	10590	+540	+1020		+1350	11	0,4
PE370			900,1050	700	10880	11000	11710	11280	+540	+1080		+1350	11/12	0,5/0,58

* PE260 i höjd 550mm ej fällbart. PE260 height 550mm not foldable.

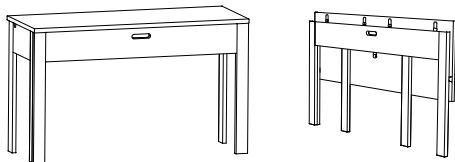

Fällbord.

Bordsskivan, tjocklek ca 22mm, och sargen av trälamell med faner i ek, ask, standardbetser på ask och vitpigmenterad ek och ask. Alternativt högtryckslaminat ek, ask, vit eller svart laminat och svart desktop. Ben i massivt trä av ek och ask. Borden kan kopplas samman på kort- och långsida med hjälp av elastiska band som är standard. Bordet är 66mm ihopfällt. Bordet levereras monterat.

Folding table.

The tabletop, thickness approx 22mm, and rim are made of blockboard with veneers in oak, ash, standard stain on ash and white glazed on oak and ash. Table top is also available in High Pressure Laminate of oak, ash, white or black laminate and black desktop. The legs are made of solid wood in oak and ash. The tables can be linked together with the help of elastic straps that are standard. The table is 66mm when it folded. The table comes pre-assembled.

Artno

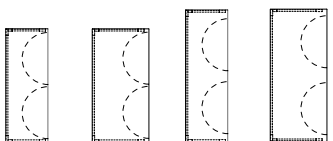

SU112045 SU112060 SU114045 SU114060

Tillbehör Accessories



PRV

Vagn. Låsbara hjul. Handtag monteras på långsida. Plats för 8 bord.

Trolley. Lockalbe castors. Handle mounted on long side. Number of tables 8 pcs.

Study SEK								Extra SEK					
Artno	Längd Length mm	Bredd Width mm	Höjd Height mm	Top Faner Veneer Ben Legs .10 ek oak .30 ask ash	Top Vit White Laminate Ben Legs .61 ek oak .63 ask ash	Top Svart Black Laminate Ben Legs .65 ek oak .67 ask ash Top laminate Ben Legs .71 ek oak .73 ask ash	Top Svart Black Desktop Ben Legs .91 ek oak .93 ask ash	Standardbets på ask Standard stain on ash Vitpigment ek ask White glazed oak ash	Tjockfaner 1,5mm pristillägg och informa- tion se sid 3 Thick veneer on table- top 1.5 mm, available at an additional cost – see page 3.	Avstånd mellan ben Distance between legs mm	Ihopfällt Folding mm	Vikt netto Weight net kilos	Volym Volume net
SU112045	1200	450	725	10090	10300	11030	10670	+1530		1152	66	14	0,1
SU112060	1200	600	725	10540	10740	11550	11160	+1570		1152	66	16	0,12
SU114045	1400	450	725	10710	10900	11770	11450	+1590		1352	66	15	0,11
SU114060	1400	600	725	11230	11460	12340	12010	+1670		1352	66	18	0,14
				Tillbehör Accessories SEK									
PRV vagn trolley	1200	740	1057	8560									1,1

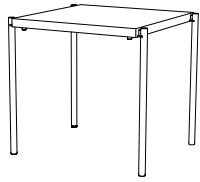

Bord Table

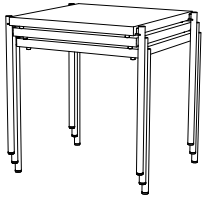

Bord staplingsbart upp till 5st
Table stackable up to 5 pcs

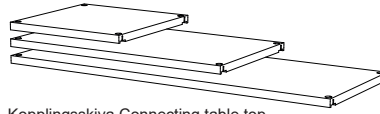

Kopplings-skiva Connecting table top

Bord stapelbart och kopplingskivor.

Bordsskivor och kopplingskivor, tjocklek ca 12/42mm tillverkas i en ramkonstruktion med toppskiva av faner i ek, björk, ask, standardbetser på ask och vitpigmenterad ek och ask. Alternativt högtryckslaminat ek, björk, ask, vit eller svart matt laminat och svart desktop. Vid laminat eller desktop välj kantlist av trä, vit eller svart plast. På undersidan sitter det en ljudabsorberande skiva med kläm- och stapelskydd. Borden är staplingsbara. Ben i vit (RAL9016) eller svart (RAL9017) stål pulverlackad finstruktur med filtass. Kopplingskivor kan förvaras på vagn eller hängas upp på vägg. Borden levereras omonterat. Benen skruvas fast under bordsskivan.

Table stackable and connection table top.

All tabletops and connecting tabletops, thickness approx 12/42mm, are made of framed construction with tops in veneers of oak, birch, ash, standard stain on ash and white glazed on oak and ash. Table top is also available in High Pressure Laminate of oak, birch, ash, white or black matte laminate and black desktop. Choose edge of wood, white or black plastic when table top is made of laminate or desktop. The underside of each table and connecting tabletops included a sound-absorbent pad, stacking and safety cover. The tables are stackable and the legs come in white (RAL9016) or black (RAL9017) steel finely textured powder coated, included felt floor protection. Store connecting tabletops on a trolley or hang them on the wall. The table comes unmounted. The legs are screwed under the table top.

Artno bord table

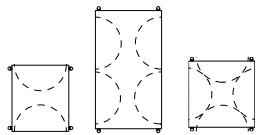

KC16070 KC112570 KC270

Kopplings-skiva Connection table top

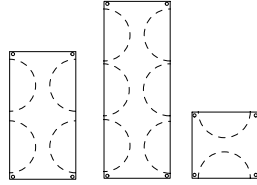

KC112570H KC118570H KC270H

Tillbehör Accessories

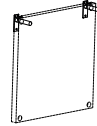

KCK2s
Upphångningsbeslag på vägg.
Svart metall. 2 kopplingskivor.

Suspension bracket on wall.
Black metal. 2 connecting tabletops.

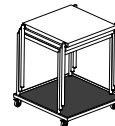

KCV70
Vagn för bord 700x700
eller 700x600. Låsbara hjul,
gummimatta. För 5 bord.

**Troelley for table 700x700 or
700x600.** Lockable castors,
rubber carpet. For 5 tables.



Kortsida Shortside



Längsida Longside

PRV
Vagn för kopplingskivor
KC270H, KC112570H.

Låsbara hjul.
Handtag monteras på kortsida: Plats för 17st.

Trolley for connecting table tops.
KC270H, KC112570H.

Lockable castors.
Handle mounted short side: 17pcs

Vagn för kopplingskiva
KC118570H.

Låsbara hjul.
Handtag monteras på långsida: Plats för 9st.

Trolley for connecting table top.
KC118570H.

Lockable castors.
Handle mounted short side: 9pcs.

Artno	Längd Length mm	Längd inkl ben Length incl. legs mm	Bredd Width mm	Höjd Height mm	Kanecct SEK			Extra SEK		Vikt netto Weight net kilos	Volym Volume net
					Top Faner Veneer .10 ek oak .20 björk birch .30 ask ash .60 vit white laminate	.61 Top Svart black Laminate Top Laminate .71 ek oak .72 björk birch .73 ask ash	.90 Top Svart black Desktop	Standardbets på ask Standard stain on ash	Tjockfaner 1,5mm pristillägg och infor- mation se sid 3		
KC16070	600	684	700	725	9570	10340	9920	+860		12	0,1
KC112570	1250	1334	700	725	11110	12160	11770	+1240		17	0,2
KC270	700	784	700	725	9760	10560	11470	+1010		13	0,11
KC112570H	1250		700		7870	8900	8540	+1240		11	0,02
KC118570H	1850		700		9390	10640	10360	+1470		16	0,02
KC270H	700		700		6490	7280	6850	+1010		7	0,01
					Tillbehör Accessories SEK						
KCK2s upph.beslag suspen.bracket					940 / 2pcs						
PRV vagn upph.skiva troelley connect	1200		740	1057	8560						1,1
KCV70 vagn för bord troelley for tables	830		830	140	5770						0,2

CAP BORD TABLE Roger Persson 2014

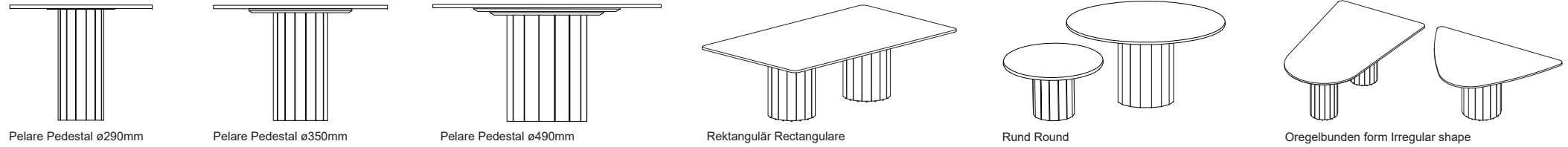

Pelarbord.

Pelare i massiv trä. Skivan, tjocklek 23mm, kan väljas mellan faner och vissa storlekar i massivt trä. Träslag är ek, björk, ask, standardfärger, standardbetser på ask och vitpigmenterad ek och ask. Alternativt högtryckslaminat (ek, björk, ask, vit, svart) samt svart desktop. Vid val av betsfärg rekommenderas skivan i faner. Special mått och andra utförande efter förfrågan. Stabilitet och balans uppnås genom rätt mängd av stenmjöl i pelaren, beroenden på bordsskivans storlek. Bordet levereras ommonterat. Pelaren skruvas fast under bordsskivan. Vid order ange höjd och utförande.

Pedestal table.

Pedestal in solid wood. Tabletop, thickness 23mm, in a choice of veneer or some dimensions in solid wood. Table come in oak, birch, ash, standard colors, standard stain on ash and white glazed on oak and ash. Table top is also available in High Pressure Laminate (oak, birch, ash, white, black) and black desktop. For stained finishes, we recommend a veneered top. Please enquire for details of non-standard sizes and other finishes. The stability and balance of the construction is achieved by adding just the right amount of stone dust inside the pillar, according to the size of the tabletop. The table comes unmounted. The pedestal screwed under the table top. When ordering state height.

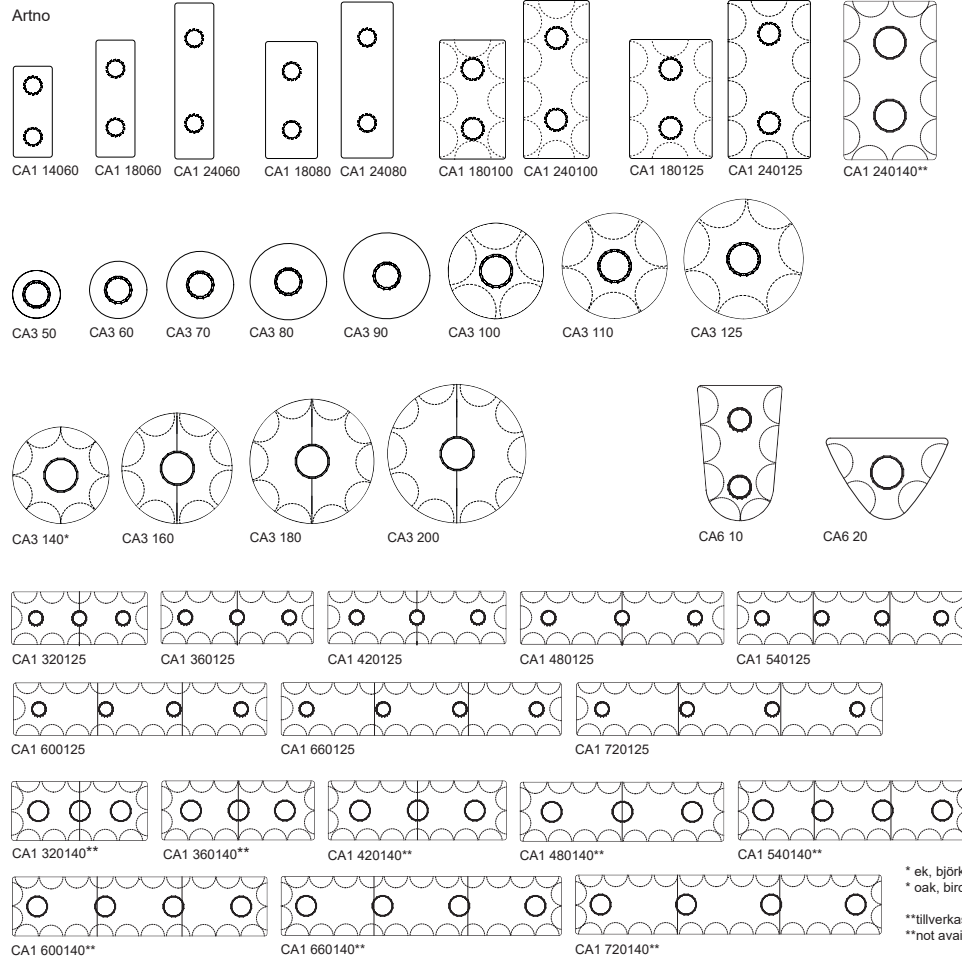

Tillbehör Accessories	Artno	Diam mm		SEK
	TKB7C	ø115	Twist. Lock borstat rostfritt stål. 2 Eluttag 2m kabel. Kan endast placeras i skiva ovanför pelare. Gäller för SE, NO, FIN, DE, NL. Twist. Brushed stainless lid. 2 Electrical, 2m cable. Placed only on table top above pedestal. For SE, NO, FIN, DE, NL.	4070
	TKB11C	ø57	Powerdot Mini. Placeras i skiva ovanför pelare alternativt i pelare lika illustration. 1 eluttag, svart, 1,5m kabel. Gäller för SE, NO, FIN, DE, NL. Powerdot Mini. Placed on top above pedestal alternative in the pedestal as the illustration. 1 electrical black, 1,5m cable. For SE, NO, FIN, DE, NL.	2200
	TKB19C	ø57	Powerdot Mini. Placeras i skiva ovanför pelare alternativt i pelare lika illustration. USB C laddare inkl. 2 portar, svart, 1,25m kabel. Gäller för SE, NO, FIN, DE, NL. Powerdot Mini. Placed on top above pedestal alternative in the pedestal as the illustration. USB C charging incl. 2 ports, black. 1,25m cable. For SE, NO, FIN, DE, NL.	2930
	TKB20C	ø70	Powerdot Midi. Kan endast placeras i skiva ovanför pelare. 1 eluttag, 1 USB C laddare, svart, 1,25m kabel. Gäller för SE, NO, FIN, DE, NL. Powerdot Midi. Placed only on table top above pedestal. 1 electrical, 1 USB C charging, black. 1,25m cable. For SE, NO, FIN, DE, NL.	2930
	TKB15C	ø160 D 105	Kabelgenomföring med elbrunn. Ett löst lock. Exkl. eluttag. Placeras i skiva ovanför pelare ø350mm. Cable slot with box. For socket and leads. One loose cover. Excl. electrical equipment. Placed on top above pedestal ø350mm.	4340
	TKB16C	ø270 D 105	Kabelgenomföring med elbrunn. Ett löst lock. Exkl. eluttag. Placeras i skiva ovanför pelare ø490mm. Cable slot with box. For socket and leads. One loose cover. Excl. electrical equipment. Placed on top above pedestal ø490mm.	4340

* ek, björk, ask laminat = delad skiva
* oak, birch, ash laminate = divided top

**tillverkas ej i ek, björk, ask laminat
**not available in oak, birch, ash laminate

CAP BORD TABLE Roger Persson 2014



Artno	Längd Length mm	Bredd Width mm	Höjd Height mm	Diam på pelare Diam on pedestal mm	Cap Bord Table SEK				Extra SEK				Vikt netto Weight net kilos	Volym Volume net
					Top Faner Veneer Pelare Pedestal .10 ek oak .20 björk birch .30 ask ash .50 lack color	Top Vit White Laminate Pelare Pedestal .61 ek oak .62 björk birch .63 ask ash	Top Svart Black Laminate Pelare Pedestal .65 ek oak .66 björk birch .67 ask ash	Top Svart Black Desktop Pelare Pedestal .91 ek oak .92 björk birch .93 ask ash	Standardbets på ask skiva Standard stain on ash top	Standardbets på ask pelare Standard stain on ash pedestal	Tjockfaner 1,5mm pristillägg och information se sid 3	Massiv skiva, klarlack Solid top, clear lacquer		
CA1 14060	1400	600	400,460,550	290	18470	18620	19220	19070	+580	+1270		+2330	106/106/108	1,54
CA1 14060	1400	600	730	290	23400	23550	24140	24000	+580	+1750		+2330	128	1,54
CA1 14060	1400	600	900,1100	290	26290	26440	27030	26880	+580	+2060		+2330	156/166	1,54
CA1 18060	1800	600	400,460,550	290	19420	19570	20270	20090	+690	+1270		+2700	120/120/122	1,92
CA1 18060	1800	600	730	290	24340	24510	25200	25030	+690	+1750		+2700	142	1,92
CA1 18060	1800	600	900,1100	290	27240	27390	28090	27910	+690	+2060		+2700	170/194	1,92
CA1 24060	2400	600	730	290	26580	26810	27740	27510	+900	+1750		+4510	156	1,92
CA1 24060	2400	600	900,1100	290	29470	29700	30620	30390	+900	+2060		+4510	186/208	1,92
CA1 18080	1800	800	730	290	26580	26810	27740	27510	+900	+1750		+4510	184	1,92
CA1 18080	1800	800	900,1100	290	29470	29700	30620	30390	+900	+2060		+4510	142/164	1,92
CA1 24080	2400	800	730	290	28170	28450	29560	29280	+1060	+1750		+5300	224	1,92
CA1 24080	2400	800	900,1100	290	31080	31350	32450	32170	+1060	+2060		+5300	198/220	1,92
CA1 180100	1800	1000	730	350	31220	31480	32490	32240	+1000	+2130		+4960	198	1,92
CA1 180100	1800	1000	900,1100	350	34900	35150	36160	35910	+1000	+2500		+4960	153/175	1,92
CA1 240100	2400	1000	730	350	34540	34860	36190	35870	+1320	+2130		+6610	234	2,30
CA1 240100	2400	1000	900,1100	350	38200	38540	39860	39530	+1320	+2500		+6610	218/240	2,30
CA1 180125	1800	1250	730	350	35360	35710	37130	36770	+1400	+2130		----	214	2,08
CA1 180125	1800	1250	900,1100	350	39020	39380	40810	40460	+1400	+2500		----	163/185	2,08
CA1 240125	2400	1250	730	350	37850	38270	39970	39540	+1650	+2130		----	254	3,0
CA1 240125	2400	1250	900,1100	350	41520	41930	43630	43210	+1650	+2500		----	233/255	3,0
CA1 240140**	2400	1400	730	490	52940	53520	55860	55270	+2330	+2620		----	370	3,2
CA1 240140**	2400	1400	900,1100	490	56470	57050	59390	59530	+2330	+2970		----	390/400	3,2
CA1 320125	3200	1250	730	350	55020	55610	57940	57360	+2310	+3200		----	310	1,85
CA1 320125	3200	1250	900,1100	350	60530	61110	63450	62860	+2310	+3750		----	320/340	1,85
CA1 360125	3600	1250	730	350	61090	61830	64750	64020	+2910	+3200		----	350	2,32
CA1 360125	3600	1250	900,1100	350	66580	67320	70260	69520	+2910	+3750		----	360/380	2,32
CA1 420125	4200	1250	730	350	69320	70260	74020	73070	+3740	+3200		----	408	2,55
CA1 420125	4200	1250	900,1100	350	74830	75750	79520	78580	+3740	+3750		----	420/450	2,55
CA1 480125	4800	1250	730	350	74520	75590	79840	78770	+4250	+3200		----	440	2,9
CA1 480125	4800	1250	900,1100	350	80020	81080	85350	84280	+4250	+3750		----	450/470	2,9

**Tillverkas ej i ek, björk ask laminat | Not available in oak, birch, ash laminate

Artno	Längd Length mm	Bredd Width mm	Höjd Height mm	Diam på pelare Diam on pedestal mm	Cap Bord Table SEK				Extra SEK				Vikt netto Weight net kilos	Volym Volume net
					Top Faner Veneer Pelare Pedestal .10 ek oak .20 björk birch .30 ask ash .50 lack color	Top Vit White Laminate Pelare Pedestal .61 ek oak .62 björk birch .63 ask ash	Top Svart Black Laminate Pelare Pedestal .65 ek oak .66 björk birch .67 ask ash Top Laminate Pelare Pedestal .71 ek oak .72 björk birch .73 ask ash	Top Svart Black Desktop Pelare Pedestal .91 ek oak .92 björk birch .93 ask ash	Standardbets på ask skiva Standard stain on ash top Vitpigment ek ask White glazed oak ash	Standardbets på ask pelare Standard stain on ash pedestal Vitpigment ek ask White glazed oak ash	Tjockfaner 1,5mm pristillägg och informa- tion se sid 3 Thick veneer on table- top 1.5 mm, available at an additional cost – see page 3.			
CA1 540125	5400	1250	730	350	86800	87910	92360	91250	+4420	+4260		540	2,32	
CA1 540125	5400	1250	900,1100	350	94140	95240	99700	98590	+4420	+4990		550/570	2,32	
CA1 600125	6000	1250	730	350	91490	92720	97620	96390	+4890	+4260		580	1,86	
CA1 600125	6000	1250	900,1100	350	98820	100060	104960	103740	+4890	+4990		590/610	1,86	
CA1 660125	6600	1250	730	350	101750	103230	109150	107660	+5920	+4260		610	2,03	
CA1 660125	6600	1250	900,1100	350	109090	110570	116490	115000	+5920	+4990		620/640	2,03	
CA1 720125	7200	1250	730	350	106950	108560	115020	113410	+6440	+4260		650	2,32	
CA1 720125	7200	1250	900,1100	350	114290	115910	122370	120750	+6440	+4990		660/680	2,32	
CA1 320140**	3200	1400	730	490	73520	74260	77180	76450	+2900	+3930		320	2,05	
CA1 320140**	3200	1400	900,1100	490	78800	79540	82480	81740	+2900	+4440		330/350	2,05	
CA1 360140**	3600	1400	730	490	80410	81330	84950	84040	+3590	+3930		384	2,56	
CA1 360140**	3600	1400	900,1100	490	85720	86610	90240	89340	+3590	+4440		400/420	2,56	
CA1 420140**	4200	1400	730	490	86240	87290	91460	90410	+4170	+3930		448	2,05	
CA1 420140**	4200	1400	900,1100	490	91540	92580	96750	95710	+4170	+4440		460/480	2,05	
CA1 480140**	4800	1400	730	490	92050	93250	98010	96820	+4760	+3930		510	2,18	
CA1 480140**	4800	1400	900,1100	490	97340	98540	103310	102120	+4760	+4440		520/550	2,18	
CA1 540140**	5400	1400	730	490	108600	109830	114800	113550	+4930	+5220		670	2,56	
CA1 540140**	5400	1400	900,1100	490	115660	116900	121860	120610	+4930	+5940		680/720	2,56	
CA1 600140**	6000	1400	730	490	119540	121050	127100	125580	+6020	+5220		744	2,70	
CA1 600140**	6000	1400	900,1100	490	126600	128110	134160	132650	+6020	+5940		760/790	2,70	
CA1 660140**	6600	1400	730	490	125350	127000	133600	131960	+6600	+5220		818	3,07	
CA1 660140**	6600	1400	900,1100	490	132410	134070	140660	139020	+6600	+5940		830/850	3,07	
CA1 720140**	7200	1400	730	490	131150	132960	140160	138360	+7190	+5220		890	3,6	
CA1 720140**	7200	1400	900,1100	490	138220	141810	147210	145420	+7190	+5940		900/950	3,6	
Oregelbunden form Irregular shape														
CA6 10	2000	1250	730	350	38190	38590	40200	39790	+1560	+2130		254	3,0	
CA6 20	1200	1800	730	490	26160	26420	27480	27210	+1040	+1310		168	1,32	

**Tillverkas ej i ek, björk ask laminat | Not available in oak, birch, ash laminate

CAP BORD TABLE Roger Persson 2014



Cap Bord Table SEK								Extra SEK					
Artno	Diam mm	Höjd Height mm	Diam på pelare Diam on pedestal mm	Top Faner Veneer Pelare Pedestal .10 ek oak .20 björk birch .30 ask ash .50 lack color	Top Vit White Laminate Pelare Pedestal .61 ek oak .62 björk birch .63 ask ash	Top Svart Black Laminate Pelare Pedestal .65 ek oak .66 björk birch .67 ask ash Top Laminate Pelare Pedestal .71 ek oak .72 björk birch .73 ask ash	Top Svart Black Desktop Pelare Pedestal .91 ek oak .92 björk birch .93 ask ash	Standardbets på ask skiva Standard stain on ash top Vitpigment ek ask White glazed oak ash	Standardbets på ask pelare Standard stain on ash pedestal Vitpigment ek ask White glazed oak ash	Tjockfaner 1,5mm pristillägg och information se sid 3 Thick veneer on table-top 1.5 mm, available at an additional cost – see page 3.	Massiv skiva, klarlack Solid top, clear lacquer	Vikt netto Weight net kilos	Volym Volume net
Rund Round													
CA3 50	ø500	400,460,550	290	9120	9190	9520	9430	+270	+620		+1110	38/38/39	0,1
CA3 50	ø500	730	290	11590	11660	11980	11900	+270	+880		+1110	50	0,13
CA3 50	ø500	900,1100	290	13020	13100	13430	13340	+270	+1020		+1110	64/80	0,2
CA3 60	ø600	400,460,550	290	9720	9810	10180	10090	+340	+620		+1350	45/45/46	0,1
CA3 60	ø600	730	290	12190	12270	12650	12550	+340	+880		+1350	52	0,13
CA3 60	ø600	900,1100	290	13620	13730	14090	14000	+340	+1020		+1350	66/83	0,2
CA3 70	ø700	400,460,550	290	10160	10260	10670	10570	+370	+620		+1540	47/52/53	0,1
CA3 70	ø700	730	290	12630	12730	13150	13030	+370	+880		+1540	64	0,13
CA3 70	ø700	900,1100	290	14070	14160	14580	14490	+370	+1020		+1540	78/89	0,2
CA3 80	ø800	400,460,550	290	11330	11450	11960	11840	+510	+620		+1990	48/56/58	0,11
CA3 80	ø800	730	290	13790	13920	14410	14300	+510	+880		+1990	66	0,13
CA3 80	ø800	900,1100	290	15240	15360	15870	15740	+510	+1020		+1990	84/96	0,17
CA3 90	ø900	460,550	350	14120	14270	14820	14670	+540	+880		+2410	58/66	0,14
CA3 90	ø900	730	290	14140	14290	14840	14700	+540	+880		+2410	68	0,16
CA3 90	ø900	900,1100	290	15600	15720	16280	16140	+540	+1020		+2410	84/96	0,18
CA3 100	ø1000	460,550	350	15390	15560	16240	16070	+660	+880		+2980	78/80	0,19
CA3 100	ø1000	730	350	17260	17430	18130	17950	+660	+1070		+2980	90	0,21
CA3 100	ø1000	900,1100	350	19100	19270	19960	19790	+660	+1260		+2980	111/119	0,23
CA3 110	ø1100	400,460,550	490	17960	18140	18830	18660	+700	+1130		+3010	71/83/85	1,25
CA3 110	ø1100	730	350	17330	17500	18180	18010	+700	+1070		+3010	97	1,25
CA3 110	ø1100	900,1100	350	19160	19320	20020	19840	+700	+1260		+3010	111/127	1,25
CA3 125	ø1250	400,460,550	490	19470	19680	20500	20290	+810	+1130		+4090	81/93/95	1,45
CA3 125	ø1250	730	350	18830	19030	19850	19660	+810	+1070		+4090	119	1,45
CA3 125	ø1250	900,1100	350	20650	20860	21690	21480	+810	+1260		+4090	121/135	1,45
CA3 140*	ø1400	730	490	25650	25930	27020	26750	+1080	+1310		----	142	1,21
CA3 140*	ø1400	900, 1100	490	27400	27680	28790	28510	+1080	+1480		----	132/146	1,21
CA3 160	ø1600	730	490	31250	31620	33130	32750	+1520	+1310		----	148	1,32
CA3 160	ø1600	900, 1100	490	33010	33380	34900	34530	+1520	+1480		----	156/170	1,32
CA3 180	ø1800	730	490	35740	36230	38160	37670	+1890	+1310		----	168	1,32
CA3 180	ø1800	900, 1100	490	37510	38000	39930	39440	+1890	+1480		----	182/196	1,42
CA3 200	ø2000	730	490	41310	41890	44230	43640	+2310	+1310		----	194	1,42
CA3 200	ø2000	900, 1100	490	43070	43650	46000	45420	+2310	+1480		----	208/222	1,42

* ek, björk, ask laminat = delad skiva
* oak, birch, ash laminate = divided top

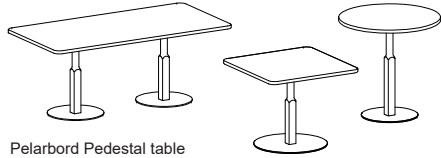

Pelarbord Pedestal table

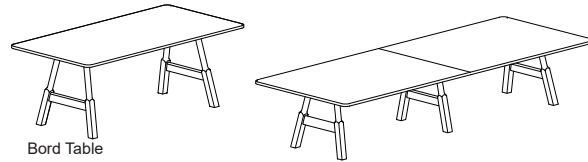

Bord Table

Pelarbord. Rektangulär, kvadratisk och rund skiva fanerad MDF, klarlack. Tjocklek ca 29mm. Faner i ek, ask, standardbetser på ask och vitpigmenterad ek eller ask. Alternativt högtryckslaminat i vit, svart, ek, ask och svart desktop. Pelaren har detalj med en övre rund del som övergår till en fyrkantig form. Är i massiv trä med stälkärna. Fotplattan är i metall och pulverlackad finstruktur av vit (RAL 9016) svart (RAL 9005), grå (RAL 9006/07) och försedd med filtassar. Bordet levereras ommonterat. Skiva skruvas på pelare. Bordskivan, pelare och fotplatta är separerbara och enkla att fräscha upp efter många års användning. Som tillbehör till rektangulär bordsskiva (ej kvadratisk, rund) finns eluttag. Specialmått och andra utförande efter förfrågan. Vid order ange artikelnummer, höjd och utförande av fotplatta.

Bord. Rektangulär skiva i fanerad trälamell, klarlack, tjocklek ca 29mm. Faner i ek, ask, standardbetser på ask och vitpigmenterad ek eller ask. Alternativt högtryckslaminat i vit, svart matt, ek, ask och svart desktop. Benstativet och sargen i massiv trä och försedd med ställfötter. Bordet levereras ommonterat. Bengavel, sarger och skiva skruvas samman. Som tillbehör till bordet finns olika eluttag. Specialmått och andra utförande efter förfrågan. Vid order ange artikelnummer, höjd och utförande.

Pedestal table. Rectangular, square and round top, veneered MDF, clear lacquer. Thickness approx 29mm. Veneer in oak, ash, standardstain on ash and white glazed oak or ash. Table top is also available in High Pressure Laminate of oak, ash, white or black and black desktop. The pedestal is in solid wood with a steel core. The table footplate is in metal, powder lacquered in white (RAL 9016), black (RAL 9005) or grey (RAL 9006/07) and has felt floor protectors. Table top, pedestal and footplate are detachable, so it is simple to freshen them up after many years' faithful service. Electrical outlets are available only for rectangular table top (not round and square) Please enquire for details of non-standard sizes and other finishes. When ordering state article number, height, finish and finish of footplate.

Table. Rectangular table top veneered blockboard, clear lacquer. Thickness approx. 29mm. Veneer in oak, ash, standardstain on ash and white glazed oak or ash. Table top is also available in High Pressure Laminate of oak, ash, white or black matte laminate and black desktop. The underframe and legs are in solid wood with adjustment screws on the feet. The table is supplied unassembled. Various power outlets are available as optional extras. Please enquire for details of non-standard sizes and other finishes. When ordering state article number, height and finish.

Artno Pelarbord Pedestal table

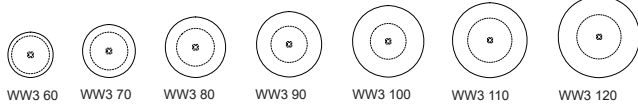
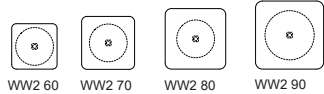
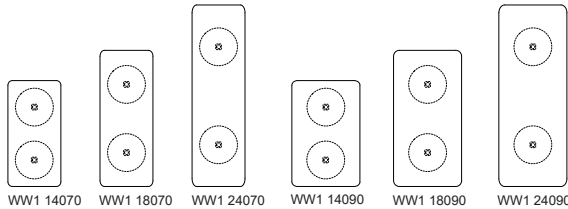

Artno Bord Table

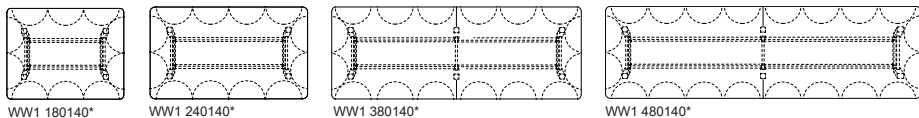
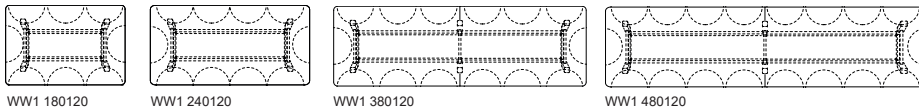
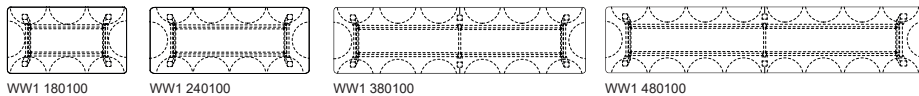

*Tillverkas ej i ek, ask laminat | Not in oak, ash laminate

Tillbehör Accessories	Artno	Dimension		SEK
	TKB4WW	L282 B127 D100	Kabelgenomföring med elbrunn, ett löst lock. Svart MDF botten L750 TJ12mm, monteras centrerat under kabelgenomföringen. Exkl. eluttag. Endast för Bord. Cable slot, for socket and leads. One loose cover. Black MDF bottom L750 and thickness 12mm placed centered under the cable slot. Excl. electrical equipment. Only for Table.	3230
	TKB14WW	L402 B127 D100	Kabelgenomföring med elbrunn, ett löst lock. Svart MDF botten L750 TJ12mm, monteras centrerat under kabelgenomföringen. Exkl. eluttag. Endast för Bord. Cable slot, for socket and leads. One loose cover. Black MDF bottom L750 and thickness 12mm placed centered under the cable slot. Excl. electrical equipment. Only for Table.	3230
	TKB7	ø115	Twist. Lock borstat rostfritt stål. 2 Eluttag. 2m kabel. Gäller för SE,NO,FIN,DE, NL. Endast för Rektangulära pelarbord och Bord. Twist. Brushed stainless lid. 2 Electrical. 2m cables. For SE, NO, FIN, DE, NL. Only for Rectangulare Pedestal table and Table	2800
	TKB11	ø57	Powerdot Mini. 1 eluttag, svart, 1,5m kabel. Gäller för SE,NO,FIN,DE,NL. Endast för Rektangulära Pelarbord och Bord. Powerdot Mini. 1electrical black, 1,5m cable. For SE,NO,FIN,DE,NL. Only for rectangulare Pedestal table and Table.	810
	TKB19	ø57	Powerdot Mini. USB C laddare inkl. 2 portar, svart, 1,25m kabel. Gäller för SE,NO,FIN,DE,NL. Endast för Rektangulär pelarbord och Bord. Powerdot Mini. USB C charging incl. 2 ports, black, 1,25m cable. For SE,NO,FIN,-DE,NL. Only for rectangulare Pedestal table and Table.	1380
	TKB20	ø70	Powerdot Midi. 1 eluttag, 1 USB C laddare, svart 1,25m kabel. Gäller för SE,NO,FIN,DE,NL. Endast för Rektangulär pelarbord och Bord. Powerdot Midi. 1 electrical, 1 USB C charging, black, 1,25m cable. For SE,NO,FIN,-DE,NL. Only for rectangulare Pedestal table and Table.	1380

Artno	Längd Length mm	Bredd Width mm	Diam. mm	Höjd Height mm	Fot Foot diam mm	Woodwork SEK				Extra SEK			Vikt netto Weight net kilos	Volym Volume net
						Top Faner Veneer Pelare Pedestal .10 ek oak .30 ask ash	Top Vit White Laminate Pelare Pedestal .61 ek oak .63 ask ash	Top Svart Black Laminate Pelare Pedestal .65 ek oak .67 ask ash	Top Svart Black Desktop Pelare Pedestal .91 ek oak .93 ask ash	Standardbets på ask skiva Standard stain on ash top	Standardbets på ask pelare/ben Standard stain on ash pedestal/legs	Tjockfaner 1,5mm pristillägg och information se sid 3		
PELARBORD PEDESTAL Rektangulär Rectangulare														
WW1 14070	1400	700		730, 900, 1050	500	21270	21480	22410	22050	+1140	+1360		76	0,51/0,56/0,61
WW1 18070	1800	700		730, 900, 1050	500	23150	23400	24380	24120	+1440	+1360		84	0,53/0,58/0,63
WW1 24070	2400	700		730, 900, 1050	500	23750	24030	25740	25110	+1530	+1360		96	0,56/0,61/0,66
WW1 14090	1400	900		730, 900, 1050	500	22250	22480	23620	23060	+1300	+1360		84	0,53/0,58/0,63
WW1 18090	1800	900		730, 900, 1050	500	24300	24540	25760	25330	+1610	+1360		96	0,56/0,61/0,66
WW1 24090	2400	900		730	500	26190	26490	28220	27590	+1890	+1360		102	0,6/0,65/0,7
Kvadratisk Square														
WW2 60	600	600		730, 900, 1050	500	11010	11090	11600	11340	+620	+690		36	0,25/0,3/0,35
WW2 70	700	700		730, 900, 1050	500	11630	11720	12430	12000	+730	+690		38	0,26/0,31/0,36
WW2 80	800	800		730, 900, 1050	500	12170	12260	13040	12560	+800	+690		42	0,27/0,32/0,37
WW2 90	900	900		730	650	13610	13750	14630	14030	+890	+690		46	0,28/0,33/0,38
Rund Round														
WW3 60			600	730, 900, 1050	500	10610	10690	11190	10940	+570	+690		35	0,25/0,3/0,35
WW3 70			700	730, 900, 1050	500	11320	11390	12100	11670	+690	+690		36	0,26/0,31/0,36
WW3 80			800	730, 900, 1050	500	11770	11870	12650	12170	+750	+690		40	0,27/0,32/0,37
WW3 90			900	730, 900, 1050	500	12430	12540	13440	12820	+830	+690		43	0,28/0,33/0,38
WW3 100			1000	730, 900, 1050	500	13330	13500	14360	13770	+990	+690		47	0,29/0,34/0,39
WW3 110			1100	730	650	14780	14960	15850	15250	+1070	+690		59/62/65	0,46/0,54/0,61
WW3 120			1200	730	650	15600	15750	16730	16080	+1200	+690		59/66/69	0,48/0,56/0,63
BORD Rektangulär TABLE Rectangulare														
WW1 180100	1800	1000		730, 900		31100	31390	32550	32260	+1560	+3100		71/75	0,31/0,35
WW1 240100	2400	1000		730, 900		34980	35350	38070	36440	+1750	+3490		115/119	0,36/0,4
WW1 380100	3800	1000		730, 900		57050	57640	59980	59390	+2860	+5710		178/184	0,56/0,46
WW1 480100	4800	1000		730, 900		65740	66490	69470	68720	+3290	+6560		218/224	0,65/0,71
WW1 180120	1800	1200		730, 900		32520	32840	34130	33810	+1630	+3260		81/85	0,33/0,37
WW1 240120	2400	1200		730, 900		38570	39000	40760	40320	+1920	+3850		105/109	0,38/0,42
WW1 380120	3800	1200		730, 900		62750	63460	66260	65550	+3140	+6270		168/174	0,58/0,48
WW1 480120	4800	1200		730, 900		76990	77950	81810	80840	+3850	+7690		208/214	0,67/0,73
WW1 180140	1800	1400		730, 900		37000	37400	----	38630	+1850	+3700		91/95	0,35/0,39
WW1 240140	2400	1400		730, 900		44520	45080	----	46750	+2230	+4440		117/121	0,38/0,42
WW1 380140	3800	1400		730, 900		68440	69270	----	71710	+3430	+6840		184/190	0,63/0,69
WW1 480140	4800	1400		730, 900		80140	81170	----	84240	+4000	+8020		228/234	0,66/0,79



H730



H900

Woodwork Light finns i rektangulära skivor av fänerad trälamell, tjocklek ca 29mm. Benstativet och sargen i massiv trä och försedd med ställskruvar. Träslag ek, ask, standardbetser på ask och vitpigmenterad ek eller ask. Skivan finns även i laminat (vit, svart, ek*, ask*) och svart desktop. Som tillbehör till bordet finns olika eluttag. Specialmått och andra utförande efter förfrågan. Bordet levereras omonterat och är lätt att demontera med handverktyg. Ange vid order: artikelnummer, höjd och utförande.

Woodwork Light is available with rectangular tops in veneered blockboard, clear lacquer. Thickness approx 29mm. The legs and underframe made of solid wood and with adjustment screws on the feet. Veneer in oak, ash, standard stains on ash, and white-pigmented oak or ash. The top is also available in laminate (white, black, oak*, ash*) and black desktop. Various power outlets are available as accessories for the table. Special sizes and other finishes are available upon request. The table is delivered unassembled and is easy to disassemble with hand tools.

When ordering, please specify: item number, height, and finish.

Artno

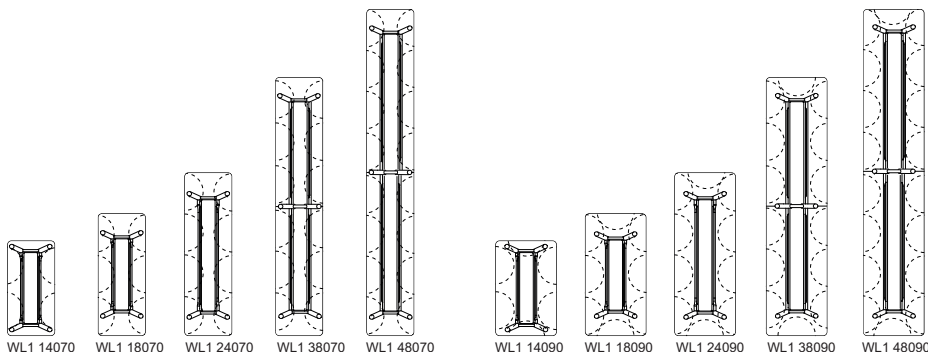

WL1 14070 WL1 18070 WL1 24070 WL1 38070 WL1 48070 WL1 14090 WL1 18090 WL1 24090 WL1 38090 WL1 48090

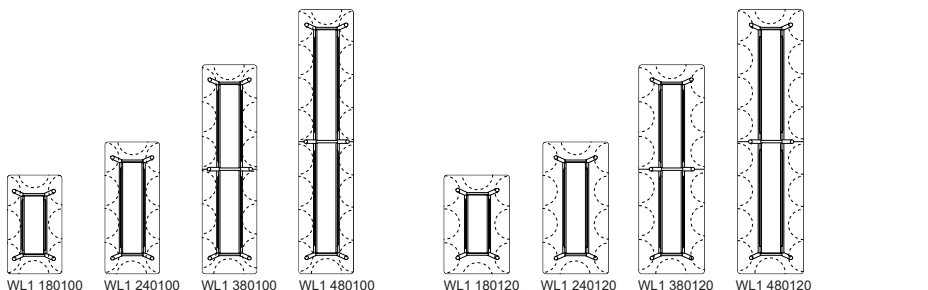

WL1 180100 WL1 240100 WL1 380100 WL1 480100 WL1 180120 WL1 240120 WL1 380120 WL1 480120

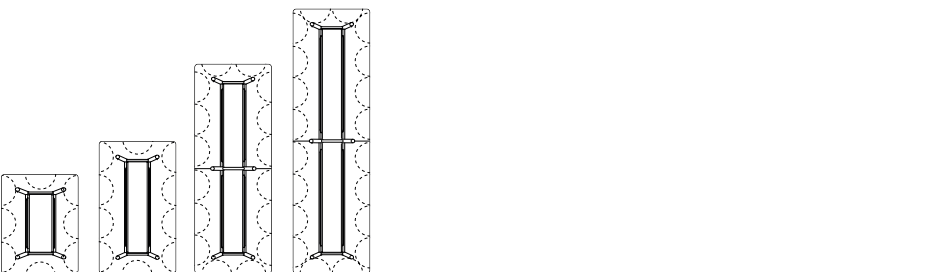

WL1 180140* WL1 240140* WL1 380140* WL1 480140* *Tillverkas ej i ek, ask laminat | Not in oak, ash laminate

Tillbehör Accessories	Artno	Dimension		SEK
	TKB4WL	L282 B127 D65= bredd width 700,900,1000 D100=bredd width 1200, 1400	Kabelgenomföring med elbrunn, lösa lock. Svart MDF botten L750 TJ12mm, monteras centrerat under kabelgenomföringen. Exkl. eluttag. Cable slot, for socket and leads. Loose covers. Black MDF bottom L750 and thickness 12mm placed centered under the cable slot. Excl. electrical equipment.	3230
	TKB14WL	L402 B127 D65= bredd width 700,900,1000 D100=bredd width 1200, 1400	Kabelgenomföring med elbrunn, lösa lock. Svart MDF botten L750 TJ12mm, monteras centrerat under kabelgenomföringen. Exkl. eluttag. Cable slot, for socket and leads. Loose covers. Black MDF bottom L750 and thickness 12mm placed centered under the cable slot. Excl. electrical equipment.	3230
	TKB7	ø115	Twist. Lock borstat rostfritt stål. 2 Eluttag. 2m kabel. Gäller för SE,NO,FIN,DE,NL. Twist. Brushed stainless lid. 2 Electrical. 2m cables. For SE, NO, FIN, DE, NL.	2800
	TKB11	ø57	Powerdot Mini. 1 eluttag, svart, 1,5m kabel. Gäller för SE,NO,FIN,DE,NL. Powerdot Mini. 1electrical black, 1,5m cable. For SE,NO,FIN,DE,NL.	810
	TKB19	ø57	Powerdot Mini. USB C laddare inkl. 2 portar, svart, 1,25m kabel. Gäller för SE,NO,FIN,DE,NL. Powerdot Mini. USB C charging incl. 2 ports, black, 1,25m cable. For SE,NO,FIN,DE,NL.	1380
	TKB20	ø70	Powerdot Midi. 1 eluttag, 1 USB C laddare, svart 1,25m kabel. Gäller för SE,NO,FIN,DE,NL. Powerdot Midi. 1 electrical, 1 USB C charging, black. 1,25m cable. For SE,NO,FIN,DE,NL.	1380

Artno	Längd Length mm	Bredd Width mm	Höjd Height mm	Woodwork Light SEK				Extra SEK			Vikt netto Weight net kilos	Volym Volume net
				Top Faner Veneer Pelare Pedestal .10 ek oak .30 ask ash	Top Vit White Laminate Pelare Pedestal .61 ek oak .63 ask ash	Top Svart Black Laminate Pelare Pedestal .65 ek oak .67 ask ash	Top Svart Black Desktop Pelare Pedestal .91 ek oak .93 ask ash	Standardbets på ask skiva Standard stain on ash top Vitpigment ek ask White glazed oak ash	Standardbets på ask ben Standard stain on ash legs Vitpigment ek ask White pigment oak ash	Tjockfaner 1,5mm pristillägg och informa- tion se sid 3 Thick veneer on table- top 1.5 mm, available at an additional cost – see page 3.		
WL1 14070	1400	700	730, 900	22040	22220	22980	22800	+1100	+2200		32/34	0,18/0,2
WL1 18070	1800	700	730, 900	23230	23430	24250	24040	+1160	+2320		42/44	0,2/0,24
WL1 24070	2400	700	730, 900	26160	26400	27390	27140	+1310	+2610		56/58	0,23/0,27
WL1 38070	3800	700	730, 900	45220	45670	47480	47030	+2260	+4520		80/84	0,37/0,43
WL1 48070	4800	700	730, 900	49770	50290	52400	51880	+2490	+4980		102/108	0,45/0,5
WL1 14090	1400	900	730, 900	23230	23430	24250	24040	+1160	+2320		42/44	0,2/0,24
WL1 18090	1800	900	730, 900	25050	25300	26290	26040	+1250	+2510		54/56	0,24/0,26
WL1 24090	2400	900	730, 900	31260	31610	33010	32660	+1560	+3130		74/76	0,3/0,34
WL1 38090	3800	900	730, 900	49060	49600	51760	51220	+2450	+4910		100/105	0,45/0,5
WL1 48090	4800	900	730, 900	64840	65680	69000	68170	+3240	+6480		134/136	0,53/0,6
WL1 180100	1800	1000	730, 900	28200	28500	29670	29380	+1410	+2820		62/64	0,25/0,29
WL1 240100	2400	1000	730, 900	32090	32460	33910	33550	+1600	+3210		82/84	0,34/0,38
WL1 380100	3800	1000	730, 900	52720	53300	55630	55050	+2630	+5270		115/120	0,5/0,55
WL1 480100	4800	1000	730, 900	61380	62130	65100	64360	+3070	+6140		152/158	0,6/0,65
WL1 180120	1800	1200	730, 900	29640	29960	31240	30920	+1480	+2960		74/76	0,34/0,36
WL1 240120	2400	1200	730, 900	35680	36120	37880	37430	+1790	+3570		98/100	0,42/0,44
WL1 380120	3800	1200	730, 900	58420	59120	61920	61220	+2920	+5840		135/142	0,6/0,65
WL1 480120	4800	1200	730, 900	72620	73580	77440	76470	+3630	+7260		178/184	0,7/0,75
WL1 180140*	1800	1400	730, 900	34100	34520	36150	35730	+1710	+3410		88/90	0,36/0,38
WL1 240140*	2400	1400	730, 900	41640	42190	44410	43860	+2080	+4160		114/116	0,44/0,46
WL1 380140*	3800	1400	730, 900	64120	64930	68200	67380	+3200	+6410		160/164	0,66/0,7
WL1 480140*	4800	1400	730, 900	75780	76800	80890	79870	+3790	+7580		206/212	0,76/0,8

*Tillverkas ej i ek, ask laminat | Not in oak, ash laminate

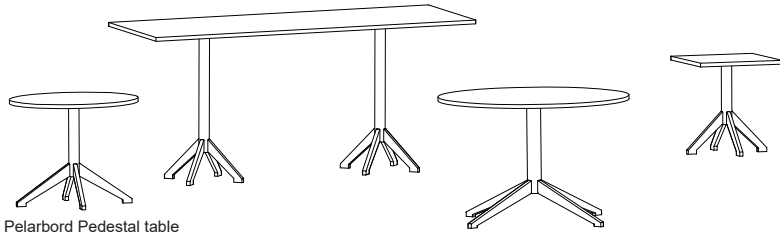

Pelarbord Pedestal table

Pelarbord "Kryssfot".

Rektangulär skiva = fanerad trälamell, klarlack.
 Kvadratisk, rund och oval skiva = fanerad MDF, klarlack.
 Tjocklek bordsskiva: ca 23mm
 Faner i ek, björk, ask, standardfärger, standardbetser på ask eller vitpigmenterad ek och ask. Alternativt är högtryckslaminat ek, björk, ask, vit eller svart samt svart desktop.
 Pelare och fotkryssat, med en karaktäristisk klack nertill är i massivt trä med ställfötter. Bordet levereras omonterat. Pelaren skruvas fast under bordsskivan. Tillval endast till rektangulära bord är eluttag. Specialmått och andra utförande efter förfrågan.
 Vid order ange utförande och höjd.

Pedestal table "4-star base".

Rectangulare top = veneered blockboard, clear lacquer.
 Square, round and oval top = veneered MDF, clear lacquer.
 Thickness table top: approx 23mm
 Veneer in oak, birch, ash, standard colors, standard stains on ash or white glazed on oak or ash. Table top i also available in High Pressure Laminate of oak, birch, ash, white or black and black desktop. The pedestal and feet with characteristic heels at the bottom are in solid wood with adjustable screws. The table comes unmounted. The pedestal screwed under the table top. Please enquire for details of non-standard sizes and other finishes.
 When ordering state finish and height.

Artno Pelarbord Pedestal table

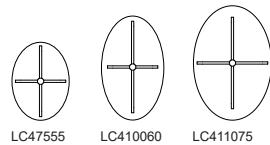
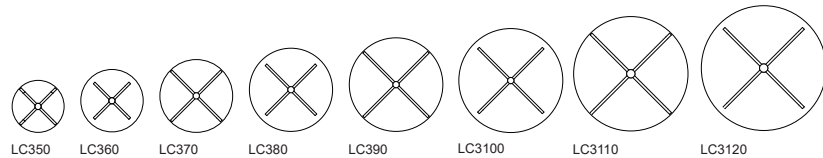
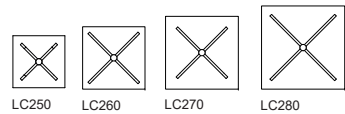
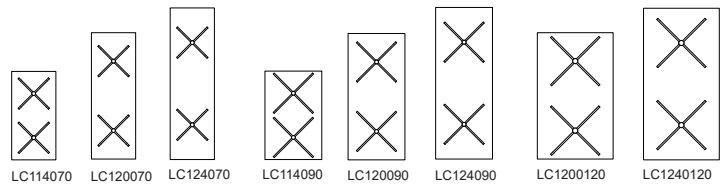

Tillbehör Accessories Endast för rektangulära pelarbord Only for rectangulare pedestal table	Artno	Diam mm		SEK
	TKB4		Kabelgenomföring med elbrunn, svart. Ett löst lock. Exkl. eluttag. Endast för rektangulära pelarbord. Cable slot with box, black. For socket and leads. One loose covers. Excl. electrical equipment. Only for rectangulare pedestal table.	3350
	TKB7	ø115	Twist. Lock borstat rostfritt stål. 2 Eluttag. 2m kabel. Gäller för SE, NO, FIN, DE, NL. Endast för rektangulära pelarbord. Twist. Brushed stainless lid. 2 Electrical. 2m cables. For SE, NO, FIN, DE, NL. Only for rectangulare pedestal table.	2800
	TKB11	ø57	Powerdot Mini. 1 eluttag, svart, 1,5m kabel. Gäller för SE,NO,FIN,DE,NL. Endast för rektangulära pelarbord. Powerdot Mini. 1electrical black, 1,5m cable. For SE,NO,FIN,DE,NL. Only for rectangulare pedestal table.	810
	TKB19	ø57	Powerdot Mini. USB C laddare inkl. 2 portar, svart, 1,25m kabel. Gäller för SE,NO,FIN,DE,NL. Endast för rektangulära pelarbord. Powerdot Mini. USB C charging incl. 2 ports, black, 1,25m cable. For SE,NO,FIN,DE,NL. Only for rectangulare pedestal table.	1380
	TKB20	ø70	Powerdot Midi. 1 eluttag, 1 USB C laddare, svart 1,25m kabel. Gäller för SE,NO,FIN,DE,NL. Endast för rektangulära pelarbord. Powerdot Midi. 1 electrical, 1 USB C charging, black. 1,25m cable. For SE,NO,FIN,DE,NL. Only for rectangulare pedestal table.	1380

Artno	Längd Length mm	Bredd Width mm	Diam. mm	Höjd Height mm	Locus SEK					Extra SEK		Vikt netto Weight net kilos	Volym Volume net
					Top Faner Veneer .10 ek oak .20 björk birch .30 ask ash	.50 Top Lack Color	Top Vit White Laminate Pelare Fot Pedestal Foot .61 ek oak .62 björk birch .63 ask ash	Top Svart Black Laminate Pelare Fot Pedestal Foot .65 ek oak .66 björk birch .67 ask ash	Top Svart Black Desktop Pelare Fot Pedesta Foot .91 ek oak .92 björk birch .93 ask ash	Standardbets på ask Standard stain on ash	Vitpigment ek ask White glazed oak ash		
PELARBOARD Rektangulär PEDESTAL Rectangulare													
LC114070	1400	700		550,620,730,900,1100	22760	19670	22960	23900	23520	+3420		34	0,3/0,36/0,4/0,5/0,6
LC120070	2000	700		550,620,730,900,1100	24890	20490	25160	26410	26170	+3710		40	0,3/0,36/0,4/0,5/0,6
LC124070	2400	700		550,620,730,900,1100	26100	21700	26350	28080	27440	+3900		45	0,3/0,36/0,4/0,5/0,6
LC114090	1400	900		550,620,730,900,1100	23960	20110	24270	26000	25370	+3590		37	0,5/0,6/0,7/0,84/1,0
LC120090	2000	900		550,620,730,900,1100	27020	21170	27320	28820	28130	+4060		43	0,5/0,6/0,7/0,84/1,0
LC124090	2400	900		550,620,730,900,1100	30620	22250	30930	32670	32020	+4590		47	0,5/0,6/0,7/0,84/1,0
LC1200120	2000	1200		730	35130	25690	35510	37090	36360	+5280		51	1,0
LC1240120	2400	1200		730	41500	26700	41980	43820	43020	+6240		55	1,0
Kvadratisk Square													
LC250	500	500		550,620,730,900,1100	10290	9150	10340	10870	10610	+1550		10	0,09/0,1/0,12/0,15/0,18
LC260	600	600		550,620,730,900,1100	11200	9610	11290	11790	11550	+1670		15	0,15/0,18/0,2/0,25/0,3
LC270	700	700		550,620,730,900,1100	12630	9760	12720	13430	13000	+1890		17	0,15/0,18/0,2/0,25/0,3
LC280	800	800		550,620,730,900,1100	13070	10250	13180	13980	13490	+1960		19	0,26/0,3/0,34/0,42/0,5
Rund Round													
LC350			ø500	550,620,730,900,1100	9860	9040	9920	10450	10180	+1500		10	0,09/0,1/0,12/0,15/0,18
LC360			ø600	550,620,730,900,1100	10490	9290	10560	11080	10810	+1560		15	0,15/0,18/0,2/0,25/0,3
LC370			ø700	550,620,730,900,1100	11890	9690	11990	12690	12260	+1800		17	0,15/0,18/0,2/0,25/0,3
LC380			ø800	550,620,730,900,1100	12260	10110	12370	13160	12650	+1860		19	0,26/0,3/0,34/0,42/0,5
LC390			ø900	550,620,730,900,1100	12690	10560	12790	13710	13090	+1910		21	0,26/0,3/0,34/0,42/0,5
LC3100			ø1000	550,620,730,900,1100	13970	11100	14110	14980	14390	+2100		23	0,26/0,3/0,34/0,42/0,5
LC3110			ø1100	730	15410	13000	15560	16450	15870	+2310		25	0,5
LC3120			ø1200	730	16660	13400	16830	17800	17150	+2500		27	0,5
Oval													
LC47555	750	550		550,620,730,900,1100	11080	9540	11160	11960	11460	+1650		12	0,2/0,23/0,26/0,4/0,48
LC410060	1000	600		550,620,730,900,1100	11890	10170	12040	12930	12330	+1800		15	0,26/0,29/0,34/0,42/0,5
LC411075	1100	750		550,620,730,900,1100	12760	10650	12940	13810	13230	+1910		18	0,37/0,4/0,48/0,6/0,71

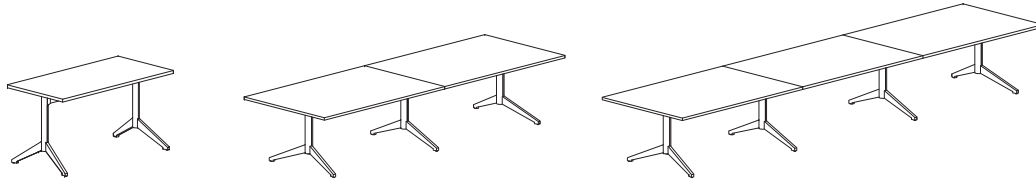

Bord "T-stativ".

Rektangulär skiva = fanerad trälamell, klarlack. Faner i ek, björk, ask, standardbetser på ask eller vitpigmenterad ek och ask. Alternativt är högtryckslaminat (ek, björk, ask, vit, svart) samt svart desktop.

Tjocklek bordsskiva: ca 28mm

Tillval är eluttag där en kabel kan föras genom pelaren och ner till golv.

Pelare och fot, med en karaktäristisk klack ner till är i massivt trä med ställfötter. Bordet levereras omonterat. Pelaren skruvas fast under bordsskivan. Vid behov kan bordsskiva och ben enkelt demonteras med enkla handverktyg. Specialmått och andra utförande efter förfrågan.

Vid order ange: Artikelnummer och utförande.

Table "T-base".

Rectangular top = veneered blockboard, clear lacquer. Veneer in oak, birch, ash, standard stains on ash or white glazed on oak or ash. Table top i also available in High Pressure Laminate of oak, birch, ash, white or black laminate and black desktop.

Thickness table top: approx 28mm

An option is an electrical outlet where one cable can be pulled through the column and down to the floor. The pedestal and feet with characteristic heels at the bottom are in solid wood with adjustable screws. The table comes unmounted. The pedestal screwed under the table top. The tabletop and leg can easily be dismantled with hand tools. Please enquire for details of non-standard sizes and finishes. When ordering state article number and finish.

Artno Bord Table

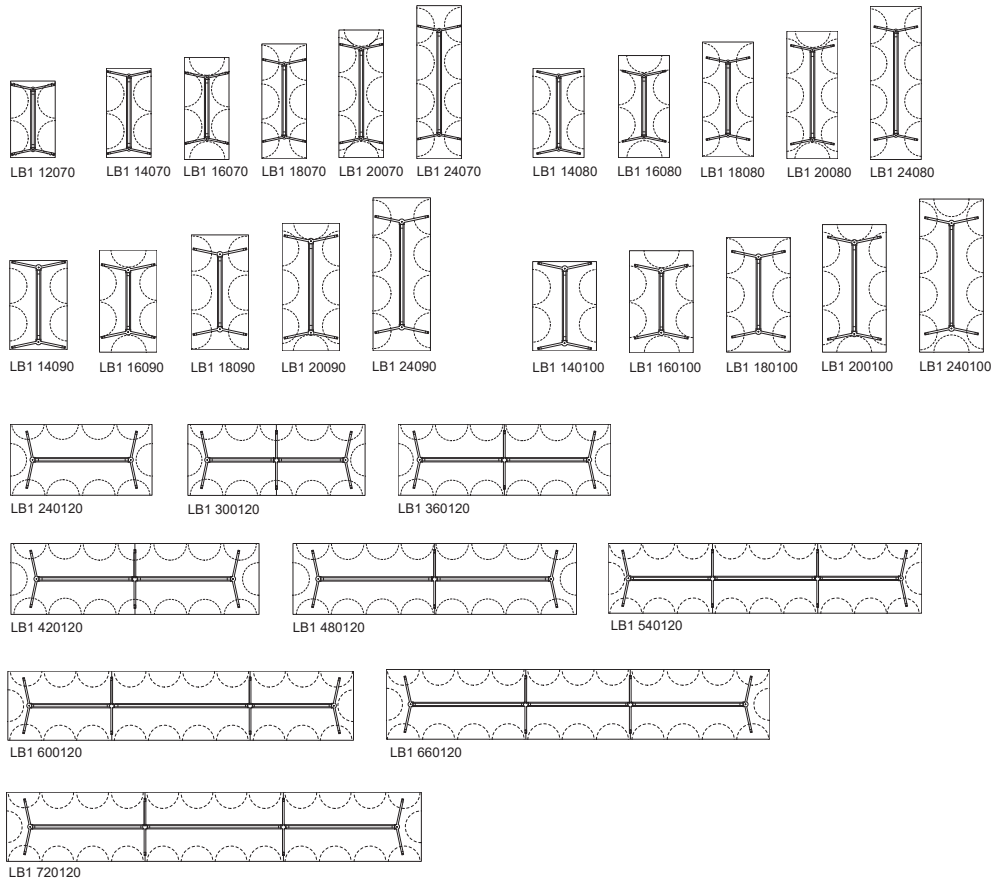

Tillbehör Accessories	Artno	Dimens. mm		SEK
	TKB1LB	Outside L388 W174 Internal L385 W123 D100	Kabelgenomföring med elbrunn. Elbrunn i svart metall monterad på balk under bordet. Lock fast med gängjärn. Exkl. eluttag. Cable slot with box in black metal assembly to the beam. Fixed lids with hinge. Excl. electrical equipment.	4040
	TKB7LB	ø115	Twist. Lock borstat rostfritt stål. 2 Eluttag. 2m kabel. Gäller för SE, NO, FIN, DE, NL. Twist. Brushed stainless lid. 2 Electrical. 2m cables. For SE, NO, FIN, DE, NL.	3120
	TKB11LB	ø57	Powerdot Mini. 1 eluttag, svart, 1,5m kabel. Gäller för SE,NO,FIN,DE,NL. Powerdot Mini. 1electrical black, 1,5m cable. For SE,NO,FIN,DE,NL.	1140
	TKB19LB	ø57	Powerdot Mini. USB C laddare inkl. 2 portar, svart, 1,25m kabel. Gäller för SE,NO,FIN,DE,NL. Powerdot Mini. USB C charging incl. 2 ports, black, 1,25m cable. For SE,NO,FIN,DE,NL.	1870
	TKB20LB	ø70	Powerdot Midi. 1 eluttag, 1 USB C laddare, svart 1,25m kabel. Gäller för SE,NO,FIN,DE,NL. Powerdot Midi. 1 electrical, 1 USB C charging, black. 1,25m cable. For SE,NO,FIN,DE,NL.	1870

Artno	Längd Length mm	Bredd Width mm	Höjd Height mm	Locus SEK				Extra SEK					
				U Avstånd från golv till underkant U Distance from floor to bottom edge of table top mm	X Avstånd från kortsida till pelare X Distance from short side to pedestal mm	Top Faner Veneer .10 ek oak .20 björk birch .30 ask ash	Top Vit White Laminate Pelare Fot Pedestal Foot .61 ek oak .62 björk birch .63 ask ash	Top Svart Black Laminate Pelare Fot Pedestal Foot .65 ek oak .66 björk birch .67 ask ash Top Laminate Pelare Pedestal .71 ek oak .72 björk birch .73 ask ash	Top Svart Black Desktop Pelare Fot Pedestal Foot .91 ek oak .92 björk birch .93 ask ash	Standardbets på ask Standard stain on ash Vitpigment ek ask White glazed oak ash	Tjockfaner 1,5mm pristillägg och infor- mation se sid 3 Thick veneer on table- top 1.5 mm, available at an additional cost – see page 3.	Vikt netto Weight net kilos	Volym Volume net
LB1 12070	1200	700	730	705	94	18090	18260	18940	18540	+2710		24	0,2
LB1 14070	1400	700	730	705	94	19280	19490	20310	20100	+2890		26	0,25
LB1 16070	1600	700	730	705	294	19730	19950	20820	20600	+2950		28	0,26
LB1 18070	1800	700	730	705	294	20860	21100	22080	21830	+3130		30	0,28
LB1 20070	2000	700	730	705	264	22270	22530	23580	23320	+3330		34	0,30
LB1 24070	2400	700	730	705	344	23650	23950	25150	24850	+3550		40	0,34
LB1 14080	1400	800	730	705	94	20430	20640	21570	21340	+3060		28	0,26
LB1 16080	1600	800	730	705	294	20940	21170	22140	21900	+3140		30	0,28
LB1 18080	1800	800	730	705	294	22210	22500	23590	23320	+3330		34	0,3
LB1 20080	2000	800	730	705	264	22930	23220	24370	24080	+3440		38	0,32
LB1 24080	2400	800	730	705	344	25330	25670	27050	26710	+3800		46	0,35
LB1 14090	1400	900	730	705	74	22320	22550	23510	23280	+3350		30	0,28
LB1 16090	1600	900	730	705	274	23580	23860	24960	24680	+3550		34	0,3
LB1 18090	1800	900	730	705	274	24150	24440	25590	25300	+3620		38	0,32
LB1 20090	2000	900	730	705	244	25770	26100	27370	27060	+3860		44	0,35
LB1 24090	2400	900	730	705	324	29580	29990	31650	31220	+4430		48	0,4
LB1 140100	1400	1000	730	705	74	23350	23620	24670	24410	+3500		34	0,3
LB1 160100	1600	1000	730	705	274	23940	24230	25380	25080	+3590		38	0,32
LB1 180100	1800	1000	730	705	274	25420	25740	27020	26710	+3820		44	0,35
LB1 200100	2000	1000	730	705	244	27150	27520	28930	28590	+4070		48	0,4
LB1 240100	2400	1000	730	705	324	31380	31840	33680	33220	+4710		54	0,42
LB1 200120	2000	1200	730	705	244	31660	32120	33960	33490	+4750		60	0,45
LB1 240120	2400	1200	730	705	324	36980	37560	39900	39310	+5550		70	0,48
LB1 300120	3000	1200	730	705	328	47830	48340	50100	49850	+7190		92	0,53
LB1 360120	3600	1200	730	705	328	55850	56500	58790	58460	+8380		110	0,64
LB1 420120	4200	1200	730	705	388	64290	65110	67960	67560	+9640		128	0,75
LB1 480120	4800	1200	730	705	388	71140	72070	75330	74860	+10670		146	0,85
LB1 540120	5400	1200	730	705	328	82390	83360	86780	86290	+12370		165	0,96
LB1 600120	6000	1200	730	705	328	88480	89580	93390	92740	+13270		183	1,07
LB1 660120	6600	1200	730	705	388	98840	100120	104620	104290	+14830		202	1,28
LB1 720120	7200	1200	730	705	388	105340	106750	111630	110940	+15800		220	1,35

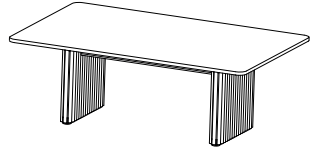

Underrede gavel / Base end legs

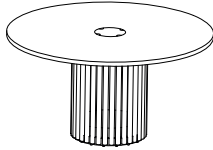

Underrede pelare / Base pedestal

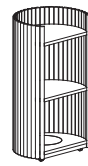
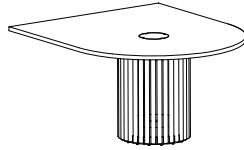

Pulpet Talarstol / Pulpit Lectern

3 fasta hyllplan. Kabelgenomföring alla hyllplan.
Botten löst lock diam 300mm. Två hjul, ej låsbara, samt två plastfötter.

3 fixed shelves. Cable slot all shelves.
Bottom loose cover diam 300mm. Two castors, not lockable and two plastic feet.

Opera. För rektangulära och ovala skivor är underredet gavlur i massivträ med ställskruvar. Runda, kvadratiska och oregelbunden skivor har rund pelare i massivträ och försedd med tyngder (ca5kg/st) för stabilitet. Bordsskivor i fanerad MDF och tjocklek ca 29mm. Utförande är ek, ask, standardbetser på ask och vitpigmenterad ek och ask. Skivan finns även i laminat (vit, svart, ek*, ask*) och svart desktop. Specialmått och andra utförande efter förfrågan. Tillval: olika eluttag. Detaljerna för eluttagen i bordet är väl genomarbetade och flexibiliteten stor eftersom man kan använda utrymmet i underredet för att dra kablage i. Åtkomst till utrymmet i underredet fås genom att några av stativets ribbor enkelt kan demonteras via magnetinfästningar. Detta ger åtkomst till bordets underliggande stativ för vidare kabeldragning i bordet och ner mot golvet. Bordet levereras omonterat där bordsskivan monteras på underredet. Det är även enkelt att demontera bordet med handverktyg. Ange vid order: Artikelnummer, höjd och utförande.

Opera. For rectangular and oval tops, the base consists of end pieces made of solid wood with adjustment screws. Round, square, and irregularly shaped tops have round solid wood columns and are equipped with weights (approx. 5kg each) for stability. The table tops are made of veneered MDF and thickness approx. 29mm. The finish options are oak, ash, standard stains on ash, and white-pigmented oak and ash. The top is also available in laminate (white, black, oak*, ash*) and black desktop. Special sizes and other finishes available upon request. Optional: various power outlets. The details for the power outlets in the table are well thought out, and the flexibility is high since the space in the base can be used for cable management. Access to this space is provided by easily detaching some of the frame's slats via magnetic fastenings. This gives access to the table's underlying frame for further cable routing inside the table and down towards the floor. The table is delivered unassembled, requiring the tabletop to be mounted on the base. It is also easy to disassemble the table with hand tools. When ordering, please specify: item number, height, and finish.

Artno

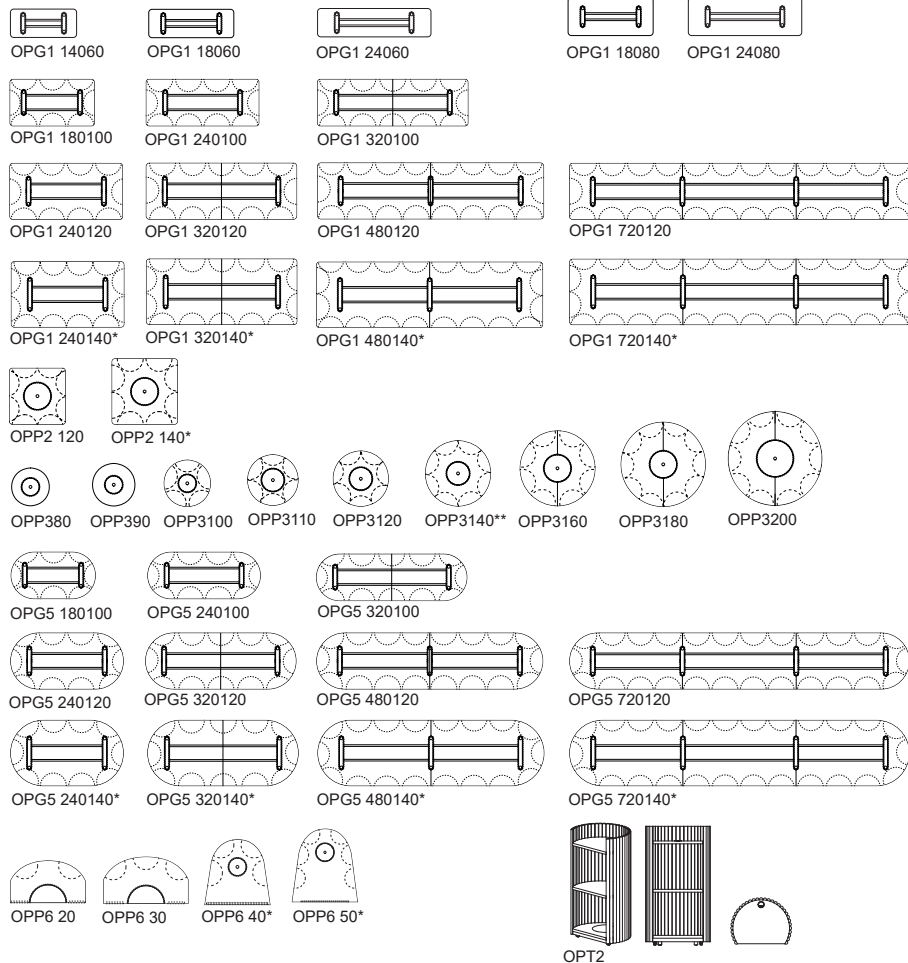

Tillbehör Accessories	Artno	Dimension		SEK
	TKB21OG	ø210 D107 = gavel end legs	Kabelgenomföring med elbrunn till bord med gavel. Placering centrerad på bordsskivan. Ett löst lock. Svart MDF botten L750 Tj12mm monteras centrerat under kabelgenomföringen mellan sarger. Exkl. eluttag. OBS! ej till B600 och 800mm. Cable slot with box for table with end legs. Placement centered on the table top. One loose cover. Black MDF bottom L750, thickness 12mm placed centered under the cable slot between the rim. Excl. electrical equipment. NOTE! not for W600 and W800mm.	3230
	TKB21OP	ø210 D91 = pelare pedestal	Kabelgenomföring med elbrunn till bord med pelare. Placering ovanför pelare. Ett löst lock. Exkl. eluttag. Cable slot with box. Placement above pedestal. One loose cover. Excl. electrical equipment.	3230
	TKB7	ø115	Twist. Lock borstat rostfritt stål. 2 Eluttag. 2m kabel. Gäller för SE,NO,FIN,DE,NL. Placering: Bord med gavel centrerad på skiva. Bord med pelare i skivan ovanför pelare. Twist. Brushed stainless lid. 2 Electrical. 2m cables. For SE, NO, FIN, DE, NL. Placement: Table with end legs centered on the tabletop. Table with pillar placed on top above pillar.	2800
	TKB11	ø57	Powerdot Mini. 1 eluttag, svart, 1,5m kabel. Gäller för SE,NO,FIN,DE,NL. Placering: Bord med gavel centrerad på skiva. Bord med pelare i skivan ovanför pelare. Powerdot Mini. 1 electrical black, 1,5m cable. For SE,NO,FIN,DE,NL. Placement: Table with end legs centered on the tabletop. Table with pillar placed on top above pillar.	810
	TKB19	ø57	Powerdot Mini. USB C laddare inkl. 2 portar, svart, 1,25m kabel. Gäller för SE,NO,FIN,DE,NL. Placering: Bord med gavel centrerad på skiva. Bord med pelare i skivan ovanför pelare. Powerdot Mini. USB C charging incl. 2 ports, black, 1,25m cable. For SE,NO,FIN,DE,NL. Placement: Table with end legs centered on the tabletop. Table with pillar placed on top above pillar.	1380
	TKB20	ø70	Powerdot Midi. 1 eluttag, 1 USB C laddare, svart 1,25m kabel. Gäller för SE,NO,FIN,DE,NL. Placering: Bord med gavel centrerad på skiva. Bord med pelare i skivan ovanför pelare. Powerdot Midi. 1 electrical, 1 USB C charging, black, 1,25m cable. For SE,NO,FIN,DE,NL. Placement: Table with end legs centered on the tabletop. Table with pillar placed on top above pillar.	1380

*Tillverkas ej i ek, ask laminat | Not in oak, ash laminate.
**Ek, ask laminat = delad skiva | Oak, ash laminate = divided top.

Artno	Längd Length mm	Bredd Width mm	Höjd Height mm	Diam på pelare Diam on pedestal mm	Opera SEK				Extra SEK			Vikt netto Weight net kilos	Volym Volume net
					Top Faner Veneer Pelare Pedestal .10 ek oak .30 ask ash	Top Vit White Laminate Pelare Pedestal .61 ek oak .63 ask ash	Top Svart Black Laminate Pelare Pedestal .65 ek oak .67 ask ash	Top Svart Black Desktop Pelare Pedestal .91 ek oak .93 ask ash	Standardbets på ask skiva Standard stain on ash top	Standardbets på ask pelare/gavel Standard stain on ash pedestal/legs	Tjockfaner 1,5mm pristillägg och information se sid 3		
Rektangulär Rectangulare													
OPG1 14060	1400	600	740		29990	30140	30720	30580	+850	+3010		40	0,2
OPG1 14060	1400	600	900		32360	32510	33090	32950	+850	+3360		44	0,22
OPG1 18060	1800	600	740		30970	31130	31750	31600	+930	+3010		52	0,22
OPG1 18060	1800	600	900		33340	33500	34120	33970	+930	+3360		54	0,24
OPG1 24060	2400	600	740		33770	33980	34810	34600	+1230	+3010		70	0,26
OPG1 24060	2400	600	900		36140	36350	37180	36970	+1230	+3360		74	0,28
OPG1 18080	1800	800	740		33140	33350	34180	33980	+1230	+3010		68	0,26
OPG1 18080	1800	800	900		35520	35720	36560	36350	+1230	+3360		72	0,28
OPG1 24080	2400	800	740		36550	36810	37850	37590	+1550	+3010		90	0,28
OPG1 24080	2400	800	900		38920	39180	40220	39960	+1550	+3360		95	0,3
OPG1 180100	1800	1000	740		37490	37740	38740	38490	+1460	+3430		85	0,3
OPG1 240100	2400	1000	740		42650	42990	44370	44020	+2050	+3430		115	0,34
OPG1 320100	3200	1000	740		49030	49480	51310	50860	+2740	+3430		150	0,44
OPG1 240120	2400	1200	740		51540	52040	54040	53540	+2930	+3870		125	0,5
OPG1 320120	3200	1200	740		55420	55970	58180	57630	+3240	+3870		165	0,6
OPG1 480120	4800	1200	740		93020	94030	98060	97050	+6010	+3870		265	0,85
OPG1 720120	7200	1200	740		133050	134570	140640	139120	+9090	+3870		390	1,0
OPG1 240140*	2400	1400	740		58080	58660	60940	60370	+3420	+4320		135	0,65
OPG1 320140*	3200	1400	740		63760	64430	67090	66420	+3960	+4320		185	0,75
OPG1 480140*	4800	1400	740		104630	105810	110510	109340	+6990	+4320		280	0,8
OPG1 720140*	7200	1400	740		149730	151500	158570	156800	+10560	+4320		410	1,1
Kvadratisk Square													
OPP2 120	1200	1200	740	600	35050	35280	36190	35960	+1370	+3610		90	0,4
OPP2 120	1200	1200	900	600	37630	37860	38770	38540	+1370	+3990		98	0,47
OPP2 140*	1400	1400	740	600	37430	37720	38890	38590	+1730	+3610		105	0,44
OPP2 140*	1400	1400	900	600	40010	40300	41460	41170	+1730	+3990		110	0,5
**Pulpet Talarstol **Pulpit Lectern	Bredd Width	Djup Depth	Höjd Height										
OPT2	640/ 600	460	1185 / 1040		18640	---	---	---	+2800 bets alla delar stain all parts	----		34	0,38

*Tillverkas ej i ek, ask laminat | Not in oak, ash laminate.

**3 fasta hyllplan. Kabelgenomföring alla hyllplan.
Botten löst lock diam 300. Två hjul, ej låsbara, samt två
plastfötter.

**3 fixed shelves. Cable slot all shelves.
Bottom loose cover diam 300. Two castors, not lockable and two plastic
feet.

Artno	Längd Length mm	Bredd Width mm	Diam. mm	Höjd Height mm	Diam på pelare Diam on pedestal mm	Opera SEK				Extra SEK			Vikt netto Weight net kilos	Volym Volume net
						Top Faner Veneer Pelare Pedestal .10 ek oak .30 ask ash	Top Vit White Laminate Pelare Pedestal .61 ek oak .63 ask ash	Top Svart Black Laminate Pelare Pedestal .65 ek oak .67 ask ash	Top Svart Black Desktop Pelare Pedestal .91 ek oak .93 ask ash	Standardbets på ask skiva Standard stain on ash top	Standardbets på ask pelare/gavel Standard stain on ash pedestal/legs	Tjockfaner 1,5mm pristillägg och infor- mation se sid 3		
Rund Round														
OPP3 80			800	900	400	23550	23680	24220	24090	+770	+2630		40	0,2
OPP3 90			900	900	400	23950	24100	24680	24530	+820	+2630		45	0,22
OPP3 100			1000	740	400	23690	23870	24580	24400	+1020	+2400		46	0,22
OPP3 100			1000	900	400	25240	25420	26120	25950	+1020	+2630		48	0,26
OPP3 110			1100	740	500	28820	29000	29700	29530	+1030	+3110		67	0,31
OPP3 110			1100	900	500	30910	31090	31790	31620	+1030	+3420		70	0,35
OPP3 120			1200	740	500	30120	30330	31160	30950	+1230	+3110		71	0,33
OPP3 120			1200	900	500	32210	32420	33250	33040	+1230	+3420		74	0,37
OPP3 140**			1400	740	500	32500	32770	33850	33580	+1580	+3110		78	0,36
OPP3 140**			1400	900	500	34590	34860	35940	35670	+1580	+3420		82	0,4
OPP3 160			1600	740	600	41410	41810	43390	42990	+2330	+3610		103	0,5
OPP3 160			1600	900	600	43990	44390	45970	45570	+2330	+3990		110	0,57
OPP3 180			1800	740	600	44320	44790	46660	46200	+2770	+3610		115	0,53
OPP3 180			1800	900	600	46900	47370	49240	48780	+2770	+3990		120	0,6
OPP3 200			2000	740	800	57040	57620	59900	59330	+3380	+4710		147	0,83
OPP3 200			2000	900	800	60730	61300	63590	63010	+3380	+5260		155	0,94
Oval														
OPG5 180100	1800	1000		740		34390	34640	35640	35390	+1460	+3430		85	0,3
OPG5 240100	2400	1000		740		42650	42990	44370	44020	+2050	+3430		115	0,34
OPG5 320100	3200	1000		740		49030	49480	51310	50860	+2740	+3430		150	0,44
OPG5 240120	2400	1200		740		47820	48320	50320	49820	+2930	+3870		125	0,5
OPG5 320120	3200	1200		740		55420	55970	58180	57630	+3240	+3870		165	0,6
OPG5 480120	4800	1200		740		93020	94030	98060	97050	+6010	+3870		265	0,85
OPG5 720120	7200	1200		740		133050	134570	140640	139120	+9090	+3870		390	1,0
OPG5 240140*	2400	1400		740		54360	54930	57220	56650	+3420	+4320		135	0,65
OPG5 320140*	3200	1400		740		63760	64430	67090	66420	+3960	+4320		185	0,75
OPG5 480140*	4800	1400		740		104630	105810	110510	109340	+6990	+4320		280	0,8
OPG5 720140*	7200	1400		740		149730	151500	158570	156800	+10560	+4320		410	1,1
Oregelbunden form Irregular shape														
OPP6 20	1600	900		740	400	31920	32150	33060	32830	+1370	+3140		85	0,35
OPP6 30	1800	1000		740	400	33440	33710	34790	34520	+1600	+3140		105	0,4
OPP6 40*	1400	1400		740	400	30650	30940	32100	31810	+1730	+2400		110	0,4
OPP6 50*	1800	2000		740	500	45540	46050	48090	47580	+3060	+3110		155	0,6

*Tillverkas ej i ek, ask laminat | Not in oak, ash laminate.

**Ek, ask laminat = delad skiva | Oak, ash laminate = divided top.

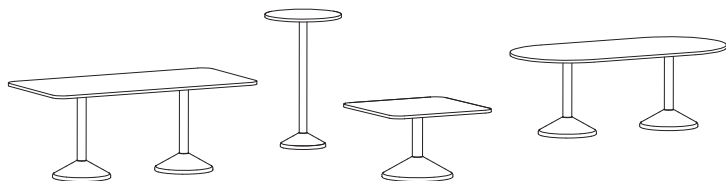

Pivå kommer i rektangulära, kvadratiska, runda och ovala former i en mängd storlekar. Skivan är i fanerad MDF med kantlist. Tjocklek ca 23mm. Pelaren är i massivträ med metallkärna och foten är i massivträ med plasttassar. Träslagen är ek, ask, standardbetser på ask och vitpigmenterad ek eller ask. Skivan finns även i laminat (vit, svart, ek, ask) och svart desktop. Som tillval till de rektangulära och ovala skivorna finns olika eluttag att välja mellan. Specialmått och andra utförande efter förfrågan. Pivå levereras omonterat. Med hjälp av handverktyg är det enkelt att separera samtliga delar av bordet, efter många års användning. Vid order var vänlig ange artikelnummer, utförande och höjd.

Pivå comes in rectangular, square, round and oval tabletops in a generous range of sizes. The tops are made of veneered MDF with an edging strip. Thickness approx 23mm. The pedestals are constructed of solid wood around a metal core and stand on a solid wood base with plastic floor protectors. Choose from oak, ash, standard stains on ash and white glaze on oak or ash. Tabletops are also available in a laminate finish (white, black, oak, ash) and as a black desktop. Several types of electrical outlet are available as optional extras for the rectangular and oval tabletops. Pivå tables are supplied unassembled. Just a few hand tools are all that is needed to disassemble the various components of the tables after many years of continuous use. Please enquire for details of non-standard sizes and other finishes. When ordering please note articlenumber, finish and height.

Artno

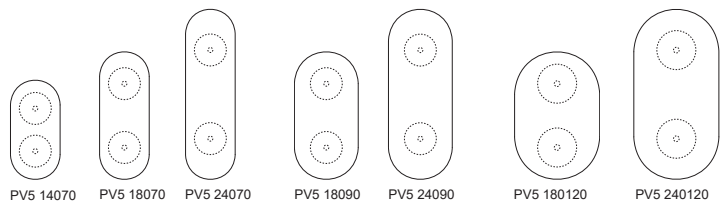
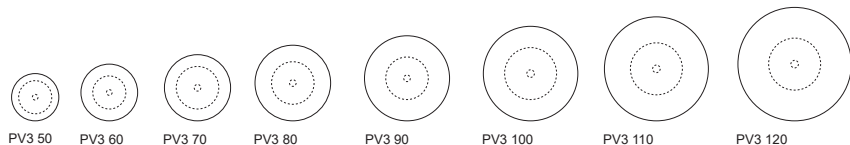
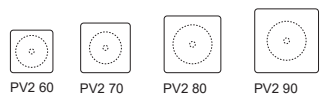
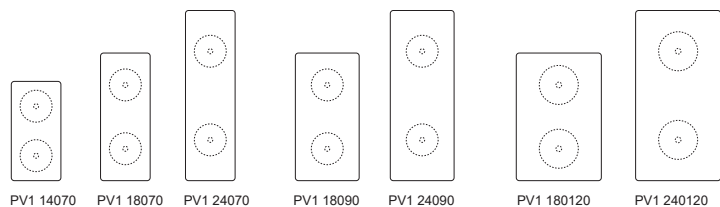

Tillbehör Accessories Endast för rektangulära och oval bord Only for rectangular and oval table	Artno	Diam mm		SEK
	TKB4		Kabelgenomföring med elbrunn, svart. Ett löst lock. Exkl. eluttag. Endast för rektangulära och ovala pelarbord. Cable slot with box, black. For socket and leads. One loose covers. Excl. electrical equipment. Only for rectangular and oval pedestal table.	3350
	TKB7	ø115	Twist. Lock borstat rostfritt stål. 2 Eluttag. 2m kabel. Gäller för SE, NO, FIN, DE, NL. Endast för rektangulära och ovala pelarbord. Twist. Brushed stainless lid. 2 Electrical. 2m cables. For SE, NO, FIN, DE, NL. Only for rectangular and oval pedestal table.	2800
	TKB11	ø57	Powerdot Mini. 1 eluttag, svart, 1,5m kabel. Gäller för SE,NO,FIN,DE,NL. Endast för rektangulära och ovala pelarbord. Powerdot Mini. 1electrical black, 1,5m cable. For SE,NO,FIN,DE,NL. Only for Only for rectangular and oval pedestal table.	810
	TKB19	ø57	Powerdot Mini. USB C laddare inkl. 2 portar, svart, 1,25m kabel. Gäller för SE,NO,FIN,DE,NL. Endast för rektangulära och ovala pelarbord. Powerdot Mini. USB C charging incl. 2 ports, black, 1,25m cable. For SE,NO,FIN,DE,NL. Only for rectangular and oval pedestal table.	1380
	TKB20	ø70	Powerdot Midi. 1 eluttag, 1 USB C laddare, svart 1,25m kabel. Gäller för SE,NO,FIN,DE,NL. Endast för rektangulära och ovala pelarbord. Powerdot Midi. 1 electrical, 1 USB C charging, black, 1,25m cable. For SE,NO,FIN,DE,NL. Only for rectangular and oval pedestal table.	1380

Artno	Längd Length mm	Bredd Width mm	Höjd Height mm	Fot Foot Diam mm	Pivå SEK				Extra SEK		Vikt netto Weight net kilos	Volym Volume net
					Top Faner Veneer .10 ek oak .30 ask ash	Top Vit White Laminate Pelare Fot Pedestal Foot .61 ek oak .63 ask ash	Top Svart Black Laminate Pelare Fot Pedestal Foot .65 ek oak .67 ask ash	Top Svart Black Desktop Pelare Fot Pedestal Foot .91 ek oak .93 ask ash	Standardbets på ask Standard stain on ash	Tjockfaner 1,5mm pristillägg och information se sid 3		
Rektangulär Rectangulare												
PV1 14070	1400	700	560	450	23830	24040	24940	24330	+2380		46	0,37
PV1 14070	1400	700	650, 730	450	24220	24430	25330	24710	+2420		50/54	0,42/0,47
PV1 14070	1400	700	900, 1050	450	25160	22620	26280	25680	+2510		60/62	0,55/0,62
PV1 18070	1800	700	560	450	24280	24510	25470	24850	+2430		58	0,4
PV1 18070	1800	700	650, 730	450	24670	24900	25850	25220	+2480		60/62	0,45/0,5
PV1 18070	1800	700	900, 1050	450	25620	23100	26800	26180	+2560		65/68	0,58/0,65
PV1 24070	2400	700	650, 730	450	26510	26790	27960	27220	+2650		70/74	0,5/0,55
PV1 24070	2400	700	900, 1050	450	27480	24980	28920	28160	+2750		80/88	0,63/0,7
PV1 18090	1800	900	650, 730	450	26200	26490	27660	26880	+2620		76/78	0,49/0,54
PV1 18090	1800	900	900,1050	450	27140	24680	28610	27840	+2710		86/92	0,62/0,69
PV1 24090	2400	900	650, 730	450	28030	28350	29730	28840	+2810		84/88	0,55/0,6
PV1 24090	2400	900	900, 1050	450	28970	26550	30700	29800	+2900		94/100	0,68/0,75
PV1 180120	1800	1200	650, 730	550	33570	33970	35550	34530	+3370		80/85	0,7/0,78
PV1 180120	1800	1200	900	550	34730	30740	32550	31540	+3470		90	0,88
PV1 240120	2400	1200	650, 730	550	35030	35460	37270	36090	+3490		90/95	0,75/0,83
PV1 240120	2400	1200	900	550	36190	32240	34280	33090	+3620		105	1,05
Kvadratisk Square												
PV2 60	600	600	560	450	12620	12740	13270	12930	+1270		20	0,24
PV2 60	600	600	650, 730	450	12800	12940	13460	13120	+1280		22/25	0,27/0,3
PV2 60	600	600	900, 1050	450	13290	13410	13950	13580	+1330		27/29	0,37/0,44
PV2 70	700	700	560	450	13640	13810	14530	14050	+1360		24	0,32
PV2 70	700	700	650, 730	450	13840	14010	14720	14250	+1380		26/27	0,37/0,4
PV2 70	700	700	900, 1050	450	14330	14510	15190	14730	+1440		30/31	0,5/0,58
PV2 80	800	800	560	550	16340	16540	17340	16800	+1640		26	0,27
PV2 80	800	800	650, 730	550	16600	16800	17600	17070	+1660		28/32	0,32/0,34
PV2 80	800	800	900, 1050	550	17190	17380	18180	17640	+1710		36/40	0,39/0,45
PV2 90	900	900	560	550	16940	17140	17990	17430	+1680		35	0,28
PV2 90	900	900	650, 730	550	17200	17400	18260	17720	+1710		37/39	0,32/0,35
PV2 90	900	900	900	550	17780	17990	18840	18290	+1780		42/44	0,39/0,45

Artno	Diam mm	Höjd Height mm	Fot Foot Diam mm	Pivå SEK				Extra SEK		Vikt netto Weight net kilos	Volym Volume net
				Top Faner Veneer .10 ek oak .30 ask ash	Top Vit White Laminate Pelare Fot Pedestal Foot .61 ek oak .63 ask ash	Top Svart Black Laminate Pelare Fot Pedestal Foot .65 ek oak .67 ask ash	Top Svart Black Desktop Pelare Fot Pedestal Foot .91 ek oak .93 ask ash	Standardbets på ask Standard stain on ash Vitpigment ek ask White glazed oak ash	Tjockfaner 1,5mm pristillägg och information se sid 3 Thick veneer on tabletop 1.5 mm, available at an additional cost – see page 3.		
Rund Round											
PV3 50	500	560	350	10490	10570	10940	10710	+1040		15	0,17
PV3 50	500	650, 730	350	10660	10740	11120	10880	+1070		16/17	0,2/0,22
PV3 50	500	900, 1050	350	11090	11160	11540	11300	+1100		19/20	0,27/0,32
PV3 60	600	560	350	11110	11210	11690	11380	+1100		17	0,24
PV3 60	600	650, 730	350	11280	11390	11870	11540	+1120		19/20	0,27/0,3
PV3 60	600	900, 1050	350	11690	11810	12280	11970	+1160		22/24	0,37/0,44
PV3 70	700	560	450	12960	13100	13710	13310	+1300		23	0,32
PV3 70	700	650, 730	450	13160	13300	13890	13510	+1310		25/27	0,37/0,4
PV3 70	700	900, 1050	450	13610	13770	14360	13980	+1360		29/31	0,5/0,58
PV3 80	800	560	450	13690	13820	14540	14070	+1360		25	0,2
PV3 80	800	650, 730	450	13860	14020	14730	14260	+1380		27/28	0,22/0,24
PV3 80	800	900, 1050	450	14340	14520	15200	14750	+1440		30/32	0,3/0,34
PV3 90	900	560	450	14400	14600	15410	14870	+1450		26	0,21
PV3 90	900	650, 730	450	14600	14800	15610	15070	+1460		27/29	0,23/0,25
PV3 90	900	900, 1050	450	15080	15270	16070	15540	+1510		31/33	0,3/0,34
PV3 100	1000	560	550	17180	17390	18290	17690	+1710		36	0,29
PV3 100	1000	650, 730	550	17430	17650	18560	17970	+1740		38/40	0,32/0,35
PV3 100	1000	900	550	18020	18230	19150	18550	+1800		42	0,41
PV3 110	1100	560	550	17860	18110	19120	18450	+1790		40	0,32
PV3 110	1100	650, 730	550	18140	18390	19390	18710	+1810		42/44	0,35/0,4
PV3 110	1100	900	550	18710	18960	19980	19290	+1870		46	0,44
PV3 120	1200	560	550	18490	18750	19810	19130	+1860		42	0,32
PV3 120	1200	650, 730	550	18760	19030	20080	19410	+1880		44/46	0,40
PV3 120	1200	900	550	19350	19610	20650	19990	+1930		48	0,45

Artno	Längd Length mm	Bredd Width mm	Höjd Height mm	Fot Foot Diam mm	Pivå SEK				Extra SEK		Vikt netto Weight net kilos	Volym Volume net
					Top Faner Veneer .10 ek oak .30 ask ash	Top Vit White Laminate Pelare Fot Pedestal Foot .61 ek oak .63 ask ash	Top Svart Black Laminate Pelare Fot Pedestal Foot .65 ek oak .67 ask ash	Top Svart Black Desktop Pelare Fot Pedestal Foot .91 ek oak .93 ask ash	Standardbets på ask Standard stain on ash	Tjockfaner 1,5mm pristillägg och information se sid 3		
Oval									Vitpigment ek ask White glazed oak ash	Thick veneer on tabletop 1.5 mm, available at an additional cost – see page 3.		
PV5 14070	1400	700	560	450	23830	24040	24940	24330	+2380		46	0,37
PV5 14070	1400	700	650, 730	450	24220	24430	25330	24710	+2420		50/54	0,42/0,47
PV5 14070	1400	700	900, 1050	450	25160	25380	26280	25680	+2510		60/62	0,55/0,62
PV5 18070	1800	700	560	450	24280	24510	25470	24850	+2430		58	0,4
PV5 18070	1800	700	650, 730	450	24670	24900	25850	25220	+2450		60/62	0,45/0,5
PV5 18070	1800	700	900, 1050	450	25620	25850	26800	26180	+2560		65/68	0,58/0,65
PV5 24070	2400	700	650, 730	450	26510	26790	27960	27220	+2650		70/74	0,5/0,55
PV5 24070	2400	700	900, 1050	450	27480	27750	28920	28160	+2750		80/88	0,63/0,7
PV5 18090	1800	900	650, 730	450	26200	26490	27660	26880	+2620		76/78	0,49/0,54
PV5 18090	1800	900	900, 1050	450	27140	27440	28610	27840	+2710		86/92	0,62/0,75
PV5 24090	2400	900	650, 730	450	28030	28350	29730	28840	+2800		84/88	0,55/0,6
PV5 24090	2400	900	900, 1050	450	28970	29310	30700	29800	+2900		94/100	0,68/0,75
PV5 180120	1800	1200	650, 730	550	33570	33970	35550	34530	+3360		80/85	0,7/0,78
PV5 180120	1800	1200	900	550	34730	35110	36690	35670	+3470		90	0,88
PV5 240120	2400	1200	650, 730	550	35030	35460	37270	36090	+3490		90/95	0,75/0,83
PV5 240120	2400	1200	900	550	36190	36620	38420	37240	+3620		105	1,05

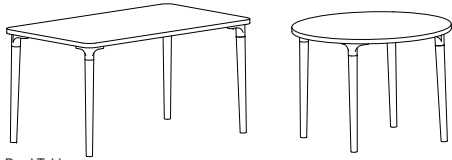

Bord Table

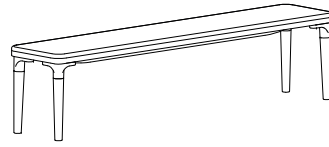

Bänk Bench

Bord.

Rektangulär skiva = fanerad trälamell, klarlack.

Rund skiva = fanerad MDF, klarlack.

Tjocklek = ca 28mm.

Träslag ek, björk, ask, standardbetser på ask eller vitpigmenterad ek och ask. Alternativt är högtrycks laminat (ek, björk, ask, vit eller svart) och svart desktop.

Ben i massiv trä med fäste av sandgjuten 100% återvunnen aluminium med kulpolerad ytbehandling som standard. Fästet kan även lackas i standardfärger, var vänlig ange vid beställning. Varje fäste är unikt med sin egen struktur och nyans av aluminium. Benet och fästet går lätt att separera från varandra. Bordet levereras omonterat. Benen skruvas fast under skivan. Specialmått och andra utförande efter förfrågan. Vid order ange artikelnummer, utförande och höjd.

Bänk.

Bänken tillverkas i träslagen ek, björk, ask, standardbetser på ask och vitpigmenterad ek eller ask. Det sandgjutna benfästet är av 100 % återvunnen aluminium med kulpolerad ytbehandling som standard. Fästet kan även lackas i standardfärger, var vänlig ange vid beställning. Varje fäste är unikt med sin egen struktur och nyans av aluminium. Dyna i kallsaum klädd i läder eller tyg. Benen är försedda med tasslar. För den cirkulära framtiden så är det enkelt att klä om dynan och separera benfästet från benen. Vid order ange namn på tyg eller läder och utförande.

Table.

Rektangulär top = veneerad blockboard, klar lacquer.

Round top = veneerad MDF, klar lacquer.

Thickness: 28mm.

Veener in oak, birch, ash, standard stains on ash or white glazed on oak and ash. Table is also available in High Pressure Laminate of oak, birch, white, black laminate and black desktop.

Legs in solid wood incl. socket-style leg mount made of sand-cast 100% recycled aluminium. The mount comes in a ball burnished finish as standard, but can also be lacquered in one of standard colors. Every mount will be unique with its own structure and shade of aluminium. The table comes unmounted. The legs are screwed under the table top.

Please enquire for details of non-standard sizes and finishes. When ordering state article number, finish and height.

Bench.

The bench is manufactured in oak, birch or ash, with standard stains on ash, or white glazed on oak and ash. The leg mount is a sand-moulded casting in 100% recycled aluminium with a ball-burnished finish as standard. The leg mount is also available in our standard lacquer finishes. Every mount will be unique with its own structure and shade of aluminium. The cold-cured foam cushion is available with a leather or fabric cover. The legs have felt floor protectors. To be able to embrace the circular economy of the future, the cushion can simply be re-covered and the legs can be detached from the leg-mount. When ordering, state the name of the fabric or leather and the desired finish.

Artno Bord Table

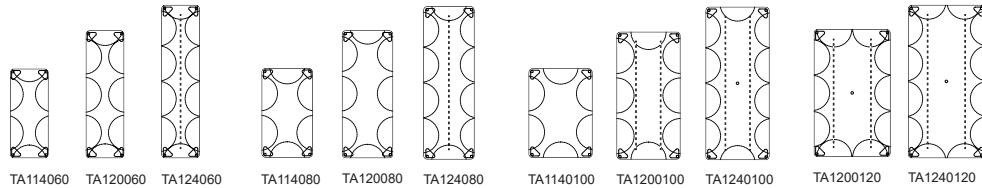

TA114060 TA120060 TA124060 TA114080 TA120080 TA124080 TA1140100 TA1200100 TA1240100 TA1200120 TA1240120

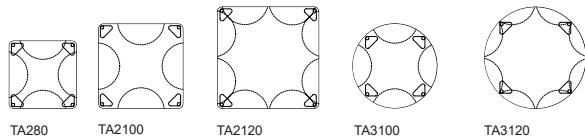

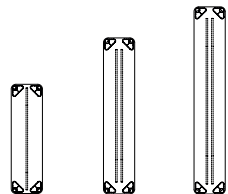

TA280 TA2100 TA2120 TA3100 TA3120

Artno Bänk Bench

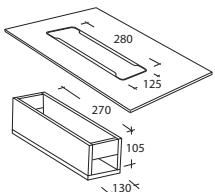
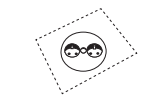
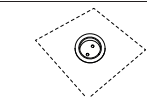
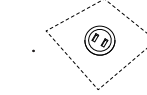

TAB1 140 TAB1 200 TAB1 240

Tillbehör Accessories	Artno	Diam mm		SEK
	TKB4		Kabelgenomföring med elbrunn, svart. Ett löst lock. Exkl. eluttag. Cable slot with box, black. For socket and leads. One loose covers. Excl. electrical equipment.	3350
	TKB7	ø115	Twist. Lock borstat rostfritt stål. 2 Eluttag. 2m kabel. Gäller för SE, NO, FIN, DE, NL. Twist. Brushed stainless lid. 2 Electrical. 2m cables. For SE, NO, FIN, DE, NL.	2800
	TKB11	ø57	Powerdot Mini. 1 eluttag, svart, 1,5m kabel. Gäller för SE,NO,FIN,DE,NL. Powerdot Mini. 1electrical black, 1,5m cable. For SE,NO,FIN,DE,NL.	810
	TKB19	ø57	Powerdot Mini. USB C laddare inkl. 2 portar, svart, 1,25m kabel. Gäller för SE,NO,FIN,DE,NL. Powerdot Mini. USB C charging incl. 2 ports, black, 1,25m cable. For SE,NO,FIN,DE,NL.	1380
	TKB20	ø70	Powerdot Midi. 1 eluttag, 1 USB C laddare, svart 1,25m kabel. Gäller för SE,NO,FIN,DE,NL. Powerdot Midi. 1 electrical, 1 USB C charging, black. 1,25m cable. For SE,NO,FIN,DE,NL.	1380

Tailor bord table SEK									Extra SEK				
Artno	Längd Length mm	Bredd Width mm	Diam. mm	Höjd Height mm	Top Faner Veneer Ben Legs .10 ek oak .20 björk birch .30 ask ash	Top Vit Laminat White Laminat Ben Legs .61 ek oak .62 björk birch 63 ask ash	Top Svart Black Laminat Ben Legs .65 ek oak .66 björk birch .67 ask ash Top Laminat Ben Legs .71 ek oak .72 björk birch .73 ask ash	Top Svart Black Desktop Ben Legs .91 ek oak .92 björk birch .93 ask ash	Standardbets på ask Standard stain on ash Vitpigment ek ask White glazed oak ash	Tjockfaner 1,5mm pristillägg och information se sid 3 Thick veneer on tabletop 1.5 mm, available at an additional cost – see page 3.	Benfäste i svart eller vit Socket style-leg in black or white	Vikt netto Weight net kilos	Volym Volume net
Rektangulär Rectangulare													
TA114060	1400	600		730,900	17000	17220	18110	17790	+2550		+840	25	0,12
TA120060	2000	600		730,900	19000	19270	20530	20270	+2860		+840	31	0,17
TA124060	2400	600		730,900	22300	22560	24340	23700	+3360		+840	35	0,2
TA114080	1400	800		730,900	18320	18550	19490	19100	+2750		+840	30	0,16
TA120080	2000	800		730,900	21200	21590	22860	22470	+3180		+840	38	0,21
TA124080	2400	800		730,900	24890	25200	26980	26330	+3730		+840	43	0,25
TA1140100	1400	1000		730,900	20630	20870	22290	21520	+3080		+840	34	0,19
TA1200100	2000	1000		730,900	26790	27110	28670	27930	+4010		+840	44	0,25
TA1240100	2400	1000		730,900	33880	34270	36130	35340	+5090		+1070	51	0,3
TA1200120	2000	1200		730,900	33880	34270	35860	35120	+5090		+1070	52	0,29
TA1240120	2400	1200		730,900	41080	41570	43390	42630	+6170		+1070	59	0,35
Kvadratisk Square													
TA280	800	800		730,900	15590	15670	16460	15970	+2350		+840	22	0,1
TA2100	1000	1000		730,900	20750	20870	21760	21200	+3090		+840	28	0,14
TA2120	1200	1200		730,900	23230	23400	24350	23710	+3480		+840	35	0,19
Rund Round													
TA3100			ø1000	730,900	15940	16080	16970	16390	+2400		+840	28	0,14
TA3120			ø1200	730,900	17350	17530	18470	17840	+2610		+840	35	0,19

Bänk Bench SEK				Extra SEK										
Artno	Längd Length mm	Bredd Width mm	Höjd Height mm	Träslag Wood .10 ek oak .20 björk birch .30 ask ash	Standardbets på ask Standard stain on ash Vitpigment ek ask White glazed oak ash	Benfäste i svart eller vit Socket style-leg in black or white	Tyg Fabric Prisgrupp 1 Pricegroup 1	Tyg Fabric Prisgrupp 2 Pricegroup 2	Tyg Fabric Prisgrupp 3 Pricegroup 3	Tyg Fabric Prisgrupp 4 Pricegroup 4	Standard Läder Leather	Tyggång på 140 cm bredd Requirement of fabric on 140 cm width	Vikt netto Weight net kilos	Volym Volume net
TAB1 14040	1400	400	470	14510	+2160	+840	+1680	+2000	+2320	+2640	+1560	85cm	30	0,34
TAB1 20040	2000	400	470	16800	+2520	+840	+1740	+2080	+2420	+2750	+2440	90cm	45	0,44
TAB1 24040	2400	400	470	18080	+2710	+840	+2490	+3050	+3620	+4180	+3580	150cm	55	0,58



Bord.

Bordsskiva av trälamell med faner i ek, bjök, standardbetser på ek och vitpigment på ek. Alternativt är högtryckslaminat i ek, björk, ask, vit och svart laminat. Tjocklek ca 23mm.

Ytbehandling är klarlack.

Ben i massivt stål med blåstrad yta i mattkrom eller slipad yta i blankkrom.

Andra mått och utförande efter förfrågan. Bordet levereras omonterat. Benen skruvas fast under bordsskivan. Vid beställning ange höjd och utförande på ben.

Table.

Table top in blockboard of veneer in oak, birch, standard stains on oak or white glazed on oak. Table is also available in High Pressure Laminate in oak, birch, ash, white and black laminate. Thickness approx 23mm.

Finish clear lacquer.

Legs of solid steel with a shot-blasted matt chrome finish, or a polished chrome surface.

Special sizes and other finishes upon request. The table comes unmounted. The legs are screwed under the table top. When ordering state height and execution of legs.

Artno

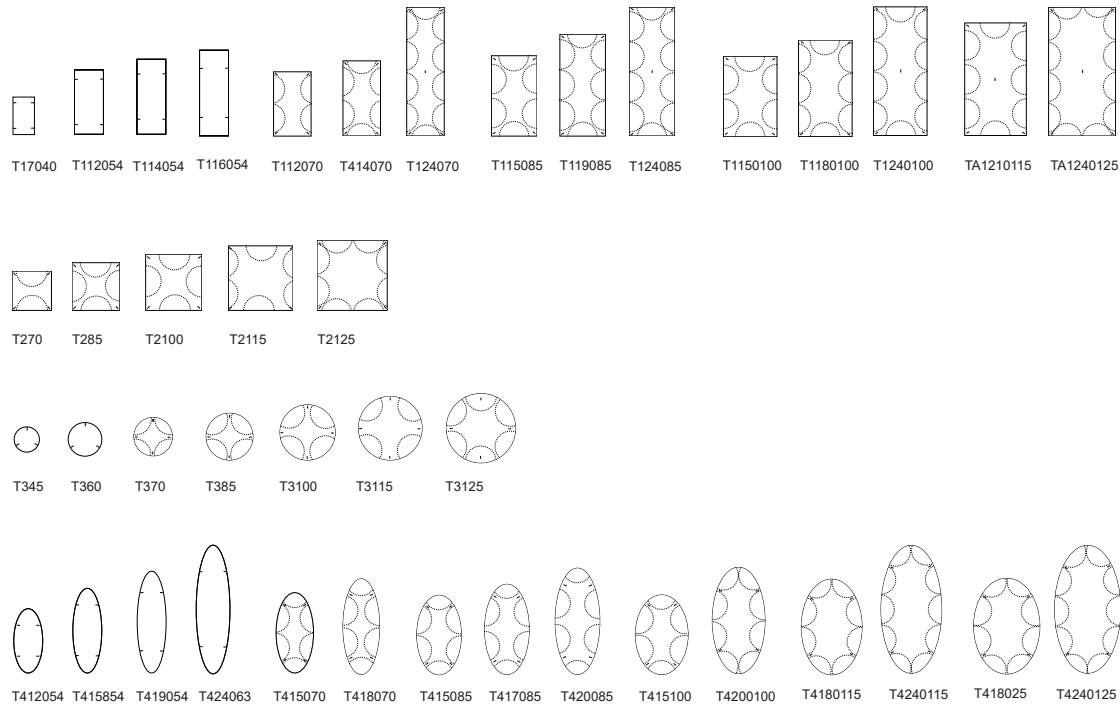

Tillbehör Accessories	Artno	Diam mm		SEK
	TKB4		Kabelgenomföring med elbrunn, svart. Ett löst lock. Exkl. eluttag. Cable slot with box, black. For socket and leads. One loose covers. Excl. electrical equipment.	3350
	TKB7	ø115	Twist. Lock borststål rostfritt stål. 2 Eluttag. 2m kabel. Gäller för SE, NO, FIN, DE, NL. Twist. Brushed stainless steel. 2 Electrical. 2m cables. For SE, NO, FIN, DE, NL.	2800
	TKB11	ø57	Powerdot Mini. 1 eluttag, svart, 1,5m kabel. Gäller för SE, NO, FIN, DE, NL. Powerdot Mini. 1 electrical black, 1,5m cable. For SE, NO, FIN, DE, NL.	810
	TKB19	ø57	Powerdot Mini. USB C laddare inkl. 2 portar, svart, 1,25m kabel. Gäller för SE, NO, FIN, DE, NL. Powerdot Mini. USB C charging incl. 2 ports, black, 1,25m cable. For SE, NO, FIN, DE, NL.	1380
	TKB20	ø70	Powerdot Midi. 1 eluttag, 1 USB C laddare, svart 1,25m kabel. Gäller för SE, NO, FIN, DE, NL. Powerdot Midi. 1 electrical, 1 USB C charging, black, 1,25m cable. For SE, NO, FIN, DE, NL.	1380

Rektangulär Rectangulare				Trippo bord table SEK			Extra SEK			
Artno	Längd Length mm	Bredd Width mm	Höjd Height mm	Top Faner Veneer .10 ek oak .20 björk birch	Top .60 Vit White laminat	Top .61 Svart Laminat Black Laminat Top Laminat .71 ek oak .72 björk birch .73 ask ash	Standardbets på ek Standard stain on oak Vitpigment på ek White glazed on oak	Tjockfaner 1,5mm pristillägg och information se sid 3 Thick veneer on tabletop 1.5 mm, available at an additional cost – see page 3.	Vikt netto Weight net kilos	Volym Volume net
T17040	700	400	400,460,530	10090	10250	10880	+500		13	0,05
T17040	700	400	620,720	15840	15910	16600	+500		22	0,06
T112054	1200	540	400,460,530	12290	12500	13250	+830		18	0,07
T112054	1200	540	620,720	18080	18280	19020	+830		27	0,08
T114054	1400	540	400,460,530	12730	12940	13780	+880		18	0,08
T114054	1400	540	620,720	18470	18680	19530	+880		27	0,09
T116054	1600	540	400,460,530	13580	13790	14670	+1030		19	0,08
T116054	1600	540	620,720	19350	19550	20440	+1030		28	0,09
T112070	1200	700	400,460,530	13340	13560	14360	+1010		22	0,1
T112070	1200	700	620,720	19090	19290	20090	+1010		31 38	0,11 0,14
T114070	1400	700	400,460,530	14460	14670	15620	+1140		24	0,12
T114070	1400	700	620,720	20220	20430	21350	+1140		33 40	0,13 0,16
T124070	2400	700	620,720	26490	26770	28490	+1610		44 51	0,15 0,18
T115085	1500	850	400,460,530	15860	16110	17010	+1360		27	0,12
T115085	1500	850	620,720	21600	21850	22770	+1360		36 43	0,13 0,16
T119085	1900	850	620,720	22960	23370	24720	+1560		40 47	0,15 0,23
T124085	2400	850	620,720	30120	30430	32160	+2200		52 59	0,18 0,21
T1150100	1500	1000	620,720	23170	23420	24820	+1580		39 46	0,18 0,21
T1180100	1800	1000	620,720	24130	24530	25910	+1750		43 50	0,21 0,24
T1240100	2400	1000	620,720	32680	33050	34940	+2550		57 64	0,28 0,31
T1210115	2100	1150	620,720	32810	33170	34840	+2590		57 64	0,27 0,3
T1240125	2400	1250	620,720	39150	39640	41480	+3520		67 74	0,33 0,36

Kvadratisk Square				Trippo bord table SEK			Extra SEK			
Artno	Längd Length mm	Bredd Width mm	Höjd Height mm	Top Faner Veneer .10 ek oak .20 björk birch	Top .60 Vit White Laminat	Top .61 Svart laminat Black Laminat Top Laminat .71 ek oak .72 björk birch .73 ask ash	Standardbets på ek Standard stain on oak Vitpigment på ek White glazed on oak	Tjockfaner 1,5mm pristillägg och information se sid 3 Thick veneer on tabletop 1.5 mm, available at an additional cost – see page 3.	Vikt netto Weight net kilos	Volym Volume net
T270	700	700	400,460.530	11670	11770	12470	+750		15	0,07
T270	700	700	620,720	17410	17510	18190	+750		24	0,08
T285	850	850	400,460.530	13010	13120	13900	+930		18	0,08
T285	850	850	620,720	18750	18870	19660	+930		27	0,09
T2100	1000	1000	400,460.530	14590	14750	15620	+1160		20	0,17
T2100	1000	1000	620,720	20370	20510	21390	+1160		29 36	0,18 0,21
T2115	1150	1150	400,460.530	16200	16400	17370	+1440		27	0,18
T2115	1150	1150	620,720	21950	22140	23100	+1440		36 43	0,19 0,22
T2125	1250	1250	400,460.530	16930	17110	18190	+1530		30	0,18
T2125	1250	1250	620,720	22960	22860	24260	+1530		39 46	0,19 0,22

Rund Round			Trippo bord table SEK			Extra SEK			
Artno	Diameter mm	Höjd Height mm	Top Faner Veneer .10 ek oak .20 björk birch	Top .60 Vit White Laminat	Top .61 Svart Laminat Black Laminat Top Laminat .71 ek oak .72 björk birch .73 ask ash	Standardbets på ek Standard stain on oak Vitpigment på ek White glazed on oak	Tjockfaner 1,5mm pristillägg och information se sid 3 Thick veneer on tabletop 1.5 mm, available at an additional cost – see page 3.	Vikt netto Weight net kilos	Volym Volume net
T345	ø450	400,460.530	7540	7630	8130	+380		9	0,04
T345	ø450	620,720	11860	11930	12440	+380		20	0,05
T360	ø600	400,460.530	8670	8770	9260	+530		12	0,05
T360	ø600	620,720	13000	13060	13570	+530		23	0,06
T370	ø700	400,460.530	11670	11750	12260	+750		16	0,06
T370	ø700	620,720	17410	17510	18190	+750		25	0,07
T385	ø850	400,460.530	13010	13120	13900	+930		20	0,07
T385	ø850	620,720	18750	18870	19660	+930		29	0,08
T3100	ø1000	400,460.530	14590	14750	15620	+1160		21	0,09
T3100	ø1000	620,720	20370	20510	21390	+1160		30	0,1
T3115	ø1150	400,460.530	16200	16390	17250	+1440		28	0,12
T3115	ø1150	620,720	21950	22120	23000	+1440		37 44	0,13 0,16
T3125	ø1250	400,460.530	16930	17110	18190	+1530		27	0,13
T3125	ø1250	620,720	22670	22820	23800	+1530		36 41	0,14 0,17

Oval				Trippo bord table SEK			Extra SEK			
Artno	Längd Length mm	Bredd Width mm	Höjd Height mm	Top Faner Veneer .10 ek oak .20 björk birch	Top .60 Vit White laminat	Top .61 Svart Laminat Black Laminat Top Laminat .71 ek oak .72 björk birch .73 ask ash	Standardbets på ek Standard stain on oak Vitpigment på ek White glazed on oak	Tjockfaner 1,5mm pristillägg och information se sid 3 Thick veneer on tabletop 1.5 mm, available at an additional cost – see page 3.	Vikt netto Weight net kilos	Volym Volume net
T412054	1200	540	400,460.530	12310	12520	13270	+830		18	0,07
T412054	1200	540	620,720	18090	18290	19030	+830		27	0,08
T415854	1580	540	400,460.530	13520	13740	14600	+1030		21	0,08
T415854	1580	540	620,720	19270	19490	20370	+1030		30	0,09
T419054	1900	540	400,460.530	14090	14330	15310	+1100		24	0,06
T419054	1900	540	620,720	19820	20060	21050	+1100		33	0,07
T424063	2400	630	400,460.530	16580	16860	18560	+1500		31	0,1
T424063	2400	630	620,720	22340	22610	24320	+1500		40	0,11
T415070	1500	700	400,460.530	14210	14460	15400	+1120		25	0,1
T415070	1500	700	620,720	19990	20240	21130	+1120		34 41	0,11 0,14
T418070	1800	700	400,460.530	15700	15920	16950	+1360		28	0,12
T418070	1800	700	620,720	21440	21670	22690	+1360		37 44	0,13 0,16
T415085	1500	850	400,460.530	15860	16060	16990	+1370		28	0,12
T415085	1500	850	620,720	21600	21830	22740	+1370		37 44	0,13 0,16
T417085	1700	850	620,720	22810	23040	23910	+1550		40 47	0,13 0,16
T420085	2000	850	620,720	23490	23900	25250	+1650		42 49	0,16 0,19
T4150100	1500	1000	400,460.530	17410	17650	19070	+1590		31	0,13
T4150100	1500	1000	620,720	23170	23420	24820	+1590		40 47	0,14 0,17
T4200100	2000	1000	620,720	25400	25730	27220	+1940		48 55	0,33 0,36
T4180115	1800	1150	620,720	27220	27600	29180	+2230		48 55	0,24 0,27
T4240115	2400	1150	620,720	34160	34640	36490	+3260		61 68	0,3 0,33
T4180125	1800	1250	620,720	28500	28900	30230	+2400		56 63	0,26 0,29
T4240125	2400	1250	620,720	36040	36510	38370	+3520		66 73	0,43 0,46

BOUQUET Jesper Ståhl 2016

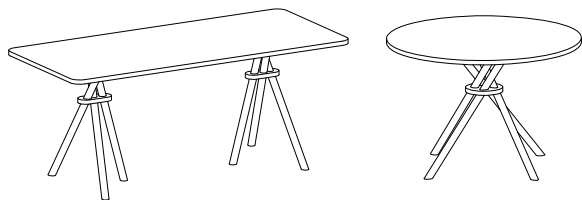

Bord.

Rektangulär skiva = Fainerad trälamell.

Rund skiva = Fainerad MDF.

Träslag ek, björk, ask, standardbets på ask, vitpigmenterad ek eller ask, vit eller svart laminat och svart desktop. Ytbehandling klarlack.

Benbock i massiv trä inkl. ställfötter. Knut i svartlackad plywood. Bordet levereras omonterat.

Benstativ skruvas fast på skivan.

Vid order ange artikelnummer och utförande.

Table.

Rectangulare top = Veneered blockboard.

Round top = veneered MDF.

Wood in oak, birch, ash, standard stain on ash or white glazed on oak or ash, and white or black laminate and black desktop. Finish in clear lacquer. Legs solid wood incl. adjustable feet on the legs. Knot in black plywood. The table comes unmounted. The legs are screwed under table top.

When ordering please note article number and finish.

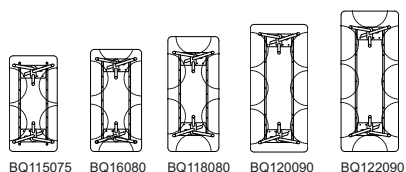

BQ115075 BQ16080 BQ118080 BQ120090 BQ122090

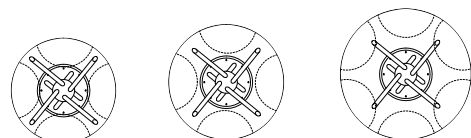

BQ3100 BQ3110 BQ3125

Tillbehör Accessories	Artno	Diam mm		SEK
	TKB4		Kabelgenomföring med elbrunn, svart. Ett löst lock. Exkl. eluttag. Endast till rektangulära bord Cable slot with box, black. For socket and leads. One loose covers. Excl. electrical equipment. Only for rectangular tables.	3350
	TKB7	ø115	Twist. Lock borstat rostfritt stål. 2 Eluttag. 2m kabel. Gäller för SE, NO, FIN, DE, NL. Endast till rektangulära bord. Twist. Brushed stainless lid. 2 Electrical. 2m cables. For SE, NO, DK, FIN, DE, NL. Only rectangular tables	2800
	TKB11	ø57	Powerdot Mini. 1 eluttag, svart, 1,5m kabel. Gäller för SE,NO,FIN,DE,NL. Endast till rektangulära bord. Powerdot Mini. 1electrical black, 1,5m cable. For SE,NO,FIN,DE,NL. Only for rectangular tables.	810
	TKB19	ø57	Powerdot Mini. USB C laddare inkl. 2 portar, svart. 1,25m kabel. Gäller för SE,NO,FIN,DE,NL. Endast till rektangulära bord. Powerdot Mini. USB C charging incl. 2 ports, black. 1,25m cable. For SE,NO,FIN,-DE,NL. Only for rectangular tables.	1380
	TKB20	ø70	Powerdot Midi. 1 eluttag, 1 USB C laddare, svart 1,25m kabel. Gäller för SE,NO,FIN,DE,NL. Endast till rektangulära bord. Powerdot Midi. 1 electrical, 1 USB C charging, black. 1,25m cable. For SE,NO,FIN,-DE,NL. Only for rectangular tables.	1380

BOUQUET Jesper Ståhl 2016

Bouquet SEK									Extra SEK			
Artno	Längd Length mm	Bredd Width mm	Diameter mm	Höjd Height mm	Top Faner Veneer Ben Legs .10 ek oak .20 björk birch .30 ask ash	Top Vit White Laminate Ben Legs .61 ek oak .62 björk birch .63 ask ash	Top Svart Laminat Black Laminate Ben Legs .65 ek oak .66 björk birch .67 ask ash	Top Svart Black Desktop Ben Legs .91 ek oak .92 björk birch .93 ask ash	Standardbets på ask Standard stain on ash Vitpigment ek ask White glazed oak ash	Tjockfaner 1,5mm pristillägg och information se sid 3 Thick veneer on tabletop 1.5 mm, available at an additional cost – see page 3.	Vikt netto Weight net kilos	Volym Volume net
Rektangulär Rectangulare												
BQ115075	1500	750		745	22420	22690	23620	23370	+3390		36	0,56
BQ116080	1600	800		745	23690	23920	24860	24690	+3560		38	0,58
BQ118080	1800	800		745	25360	25600	26750	26350	+3820		40	0,60
BQ120090	2000	900		745	27080	27370	28890	28170	+4060		40	0,64
BQ122090	2200	900		745	28390	28750	30440	29690	+4260		44	0,66
Rund Round												
BQ3100			ø1000	745	14520	14640	15530	14960	+2200		25	0,20
BQ3110			ø1100	745	14590	14760	15640	15060	+2220		28	0,23
BQ3125			ø1250	745	16110	16270	17230	16590	+2410		34	0,26

MANDALA Anki Gneib Mia Cullin 2026

Mandala är ett soffbord som formgivits utifrån experiment med pappersark. Borden tillverkas genom att faner böjs manuellt och sammanfogas i en central nod. Ordet Mandala betyder cirkel eller centrum på sanskrit och är en universell symbol för helhet och harmoni, där allt kretsar kring centrumpunkten.

Träslag är ek, ask, standardbets på ask, vitpigment ek eller ask. Glasskivan 8mm, finns som klarglas eller bronsfärgad. Skivan ligger löst på bladen.

Bladen tillverkas i faner och kan då väljas mellan tre varianter: Utsida/insida samma träslag eller bets. Utsida trä/insida bets. Utsida bets/insida trä. Centrumnoden är i samma utförande som utsidan på faneret.

För att förstärka hopsättningen mellan bladen sitter två små nitlar i metall.

Till ek och ask är ytbehandling mässing och till standardbets är ytbehandling antikmässing.

Vid beställning ange artikelnummer och utförande.

Mandala is a table designed based on experiments with sheets of paper. The tables are made by manually bending veneer and joining them together at a central node. The word Mandala means circle or center in Sanskrit and is a universal symbol for wholeness and harmony, where everything revolves around the center point.

Wood types are oak, ash, standard stain on ash, white pigment oak or ash. The glass top is 8 mm, available as clear glass or bronze-colored. The top lies loosely on the base.

The leaves are made of veneer and can then be chosen between three variants: Outside/inside same wood type or stain. Outside wood/inside stain. Outside stain/inside wood. The center node is in the same design as the outside of the veneer. To reinforce the assembly between the leaves, there are two small metal rivets. For oak and ash, the surface treatment is brass and for standard stains, the surface treatment is antique brass.

When ordering please state article number and finish.

Artno

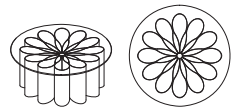

12 blad sheets
MD3 9540GT = klarglas clear glass
MD3 9540GB = bronglas bronze glass

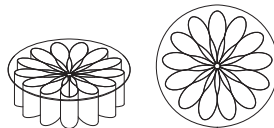

13 blad sheets
MD3 11535GT = klarglas clear glass
MD3 11535GB = bronglas bronze glass

		Mandala SEK		Extra SEK			
Artno	Diameter mm	Höjd Height mm	.10 ek oak .30 ask ash	Standardbets på ask Standard stain on ash Vitpigment ek ask White glazed oak ash	Standardbets på ask Standard stain on ash Vitpigment ek ask White glazed oak ash	Vikt netto Weight net kilos	Volym Volume net
MD3 9540GT	950	400	20490	BETS HELA BORDET STAIN ALL TABLE	BETS INSIDA ELLER UTSIDA STAIN INSIDE OR OUTSIDE	22	0,36
MD3 9540GB	950	400	21910			22	0,36
MD3 11535GT	1150	350	24130			31	0,46
MD3 11535GB	1150	350	26200			31	0,46

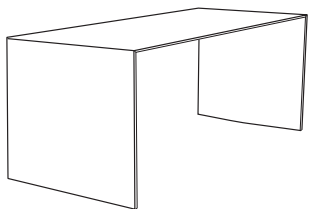

Utgående produkt med reservation för slutförsäljning.

Bord.

Vit kompaktaminat alternativt svartbets på ask.
Andra längder och höjder efter förfrågan. Bordet levereras monterat
Vid order ange höjd.

Outbound product with reservation for end of stock.

Table.

White compact laminate or black stain on ash.
Other lengths and heights upon request. The table comes pre-assembled.
When ordering state height.

Artno

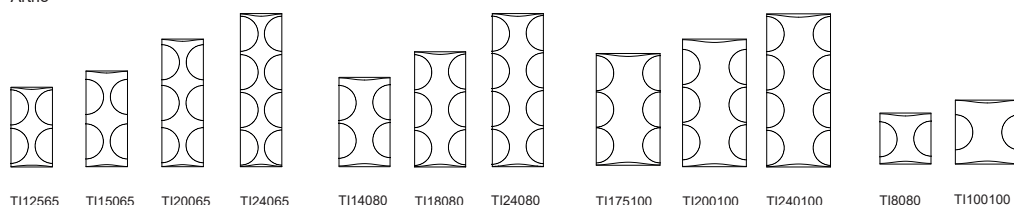

Thinner SEK

Artno	Längd Length mm	Bredd Width mm	Höjd Height mm	.60 vit white laminate	.30 svartbets ask col.11 black stain on ash col. 11	Vikt netto Weight net kilos	Volym Volume net
TI12565	1250	650	400,480	20800	30980	25/26	0,5/0,55
TI12565	1250	650	730,900	29360	40960	28/31	0,8/1,0
TI15065	1500	650	400,480	22550	32910	35/36	0,6/0,65
TI15065	1500	650	730,900	29620	41350	38/41	0,95/1,15
TI20065	2000	650	730,900	32440	44880	48/51	1,25/1,5
TI24065	2400	650	730,900	34840	48970	58/61	1,45/1,8
TI14080	1400	800	400,480	24030	34900	31/32	0,67/0,75
TI14080	1400	800	730,900	31200	43590	34/37	1,1/1,3
TI18080	1800	800	730,900	33200	46080	44/47	1,35/1,65
TI24080	2400	800	730,900	39960	55360	54/57	1,8/2,15
TI175100	1750	1000	730,900	36540	50450	40/43	1,65/2,0
TI200100	2000	1000	730,900	38950	54540	50/53	1,85/2,25
TI240100	2400	1000	730,900	45120	61950	60/63	2,2/2,65
TI8080	800	800	400,480	21810	32240	21/22	0,4/0,45
TI8080	800	800	730,900	30610	42410	24/27	0,66/0,8
TI100100	1000	1000	400,480	24460	35550	30/31	0,62/0,67
TI100100	1000	1000	730,900	31790	44440	33/36	1,0/1,2

Tillbehör Accessories	Artno	Diam mm		SEK
	TKB4		Kabelgenomföring med elbrunn, svart. Ett löst lock. Exkl. eluttag. Cable slot with box black. For socket and leads. One loose covers. Excl. electrical equipment.	3670
	TKB7	ø115	Twist. Lock borstat rostfritt stål. 2 Eluttag. 2m kabel. Gäller för SE, NO, FIN, DE, NL. Twist. Brushed stainless lid. 2 Electrical. 2m cables. For SE, NO, FIN, DE, NL.	2800
	TKB5	ø68	Kabelgenomföring. Cable slot.	630
	TIH		Låsbara hjul, 4st svart. Lockable castors. 4pcs black.	2500/4pcs

CAP PODIUM Roger Persson 2021

Pelare och skiva i massiv trä. Skivan har en nedfasad kant, tjocklek ca 22mm. Träslagen är ek, björk, ask, standardfärger, standardbetser på ask och vitpigmenterad ek och ask. Vid standardfärg är skivan i MDF. Specialmått och andra utförande efter förfrågan. Podium levereras monterad med skiva. Vid beställning ange artikelnummer och höjd.

Pedestal and table top in solid wood. The table top is milled down, thickness approx 22mm. Choose between oak, birch, ash, standard colors, standard stain on ash and white glazed on oak and ash. When using the standard colors the table top made in MDF. Special dimensions and other designs on request. The Cap podium comes mounted. When ordering state article number and height.

Artno

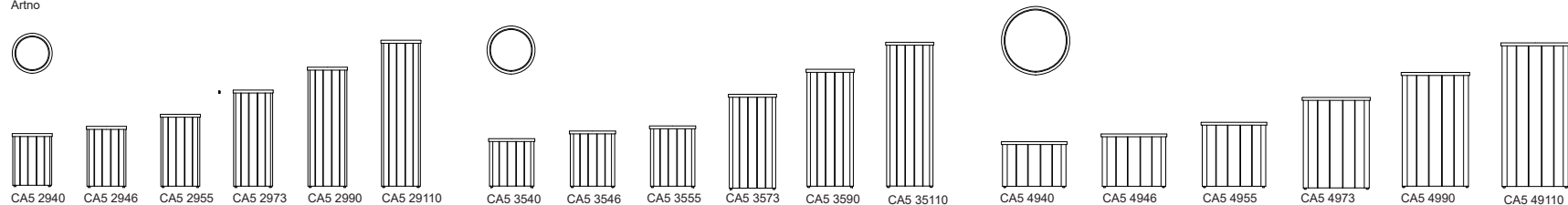

Artno	Diam mm	Höjd Height mm	Cap Podium SEK	Extra SEK		Vikt netto Weight net kilos	Volym Volume net
			Top Massiv solid wood Pelare Pedestal .10 ek oak .20 björk birch .30 ask ash .50 lack color	Standardbets på ask skiva Standard stain on ash top Vitpigment ek ask White glazed oak ash	Standardbets på ask pelare Standard stain on ash pedestal Vitpigment ek ask White glazed oak ash		
CA5 2940	290	395	8960	+440	+870	8	0,04
CA5 2946	290	455	8960	+440	+870	8	0,05
CA5 2955	290	545	8960	+440	+870	9	0,08
CA5 2973	290	725	11430	+440	+870	12	0,08
CA5 2990	290	895	12850	+440	+870	14	0,1
CA5 29110	290	1095	12850	+440	+870	16	0,12
CA5 3540	350	380	11930	+580	+1090	8	0,07
CA5 3546	350	440	11930	+580	+1090	10	0,08
CA5 3555	350	530	11930	+580	+1090	10	0,09
CA5 3573	350	710	13840	+580	+1090	11	0,12
CA5 3590	350	880	15620	+580	+1090	18	0,15
CA5 35110	350	1080	15620	+580	+1090	20	0,18
CA5 4940	490	355	15530	+610	+1310	21	0,17
CA5 4946	490	415	15530	+610	+1310	22	0,18
CA5 4955	490	505	15530	+610	+1310	22	0,19
CA5 4973	490	685	17340	+610	+1280	23	0,22
CA5 4990	490	855	19130	+610	+1500	27	0,27
CA5 49110	490	1080	19130	+610	+1500	29	0,33
Tillbehör Accessories							
TKB11C	57		2200 svart black				

Tillbehör Accessories



TKB11C

Powerdot Mini. Placeras i pelare. 1 eluttag, svart, 1,5m kabel.
Gäller för SE,NO, FIN,DE,NL.
Powerdot Mini. Placed in the pedestal. 1 electrical black, 1,5m cable.
For SE,NO, FIN,DE,NL

LOLLIPOP Malin Lundmark 2014, 2019

Bord och Skål.

Bordet finns i fyra höjder och tre storlekar på skivan. Foten är av gjuten betong eller lackad i standardfärger. Stativet finns i blank krom eller lackad i standardfärger, med eller utan ring. Bordskivan i massiv ek, björk, ask, standardfärger, standardbetsler på ask och vitpigmenterad ek eller ask. Tjocklek ca 25/22mm. Som tillbehör finns lackad fot i standardfärger och tre krokar i blankkrom som hängs under bordsskivan.

Skålen inkl. planteringskärl finns i fyra höjder och en storlek. Foten är av gjuten betong. Pelare i blankkrom eller standardfärger. Planteringskärl är svart ABS plast. Som tillbehör finns lackad fot i standardfärger.

Den gjutna betongfoten får bäst stabilitet på hårda golv som parkett, klinkers, betong, plastmatta eller liknande. Undvik att placera bordet på tjocka och mjuka mattor med lugg där Lollipop kan bli något instabilt.

Bordet och skål levereras monterat. Vid beställning ange artikelnummer, utförande och höjd.

Table and Bowl.

The table comes in four heights with tops in three different sizes. Choose a frame with or without a ring in shiny chrome or standard colors finishes. The table top is in solid oak, birch, ash or finished in our standard colors, standard stains on ash or white glazed oak or ash. Thickness approx 25/22mm. Maximum three hooks in polished chrome are available as optional extras to hang things on below the table surface.

The planter, complete with a bowl for plants, comes in four heights and one size. The cast concrete foot is also available lacquered in our standard colours. The pillar comes in polished chrome or standard colors. The planting bowl is in black plastic ABS.

The concrete foot stands best on surfaces such as parquet flooring, quarry tiles, concrete, plastic matting or similar. Avoid placing the table on thick rugs or those with a soft pile as there is a risk that the table may be less stable on this kind of surface.

Tables and planters are delivered assembled. When ordering, please state article number, height and choice of finish.

Artno Bord Table



LO329 50R = H 500/750
LO329 55R = H 550/800

ø290

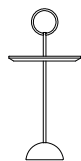

LO338 50R = H 500/750
LO338 55R = H 550/800

ø380

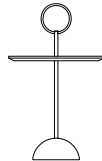

LO350 50R = H 500/750
LO350 55R = H 550/800

ø500



LO329 90R = H 900/1175
LO329 105R = H 1050/1325

ø290

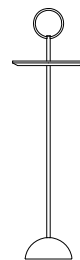

LO338 90R = H 900/1175
LO338 105R = H 1050/1325

ø380

Artno Skål Bowl



LOS60 = H 600
LOS65 = H 650



LOS100 = H 1000
LOS115 = H 1150



LO329 50U = H 500
LO329 55U = H 550

ø290



LO338 50U = H 500
LO338 55U = H 550

ø380



LO350 50U = H 500
LO350 55U = H 550

ø500



LO329 90U = H 900
LO329 105U = H 1050

ø290



LO338 90U = H 900
LO338 105U = H 1050

ø380

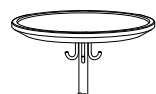

LOK

Krok blankkrom (max 3 krokar per bord)
Hooks polished chrome (max 3 hooks per table)

				Lollipop SEK	Extra SEK		
Artno Pelare blankkrom Pedestal polish chrome	Artno Pelare lack Pedestal color	Diameter mm	Höjd skiva/Höjd med ring Height top/height inkl. ring mm	.10 ek oak .20 björk birch .30 ask ash .50 lack color	Standardbets på ask Standard stain on ash Vitpigment ek ask White glazed oak ash	Vikt netto Weight net kilos	Volym Volume net
Inclusive Ring							
LO329 50RK*	LO329 50RL*	ø290	500/750	5300	+360	9	0,10
LO329 55RK*	LO329 55RL*	ø290	550/800	5300	+360	9	0,10
LO329 90RK	LO329 90RL	ø290	900/1175	6390	+360	15	0,20
LO329 105RK	LO329 105RL	ø290	1050/1325	6390	+360	15	0,20
LO338 50RK*	LO338 50RL*	ø380	500/750	5780	+440	10	0,15
LO338 55RK*	LO338 55RL*	ø380	550/800	5780	+440	10	0,15
LO338 90RK	LO338 90RL	ø380	900/1175	6850	+440	16	0,20
LO338 105RK	LO338 105RL	ø380	1050/1325	6850	+440	16	0,20
LO350 50RK	LO350 50RL	ø500	500/750	7370	+580	17	0,16
LO350 55RK	LO350 55RL	ø500	550/800	7370	+580	17	0,16
Exclusive Ring							
			Höjd skiva Height top				
LO329 50UK*	LO329 50UL*	ø290	500	4540	+360	8	0,07
LO329 55UK*	LO329 55UL*	ø290	550	4540	+360	8	0,07
LO329 90UK	LO329 90UL	ø290	900	5390	+360	14	0,17
LO329 105UK	LO329 105UL	ø290	1050	5390	+360	14	0,17
LO338 50UK*	LO338 50UL*	ø380	500	5030	+440	9	0,10
LO338 55UK*	LO338 55UL*	ø380	550	5030	+440	9	0,10
LO338 90UK	LO338 90UL	ø380	900	5870	+440	15	0,17
LO338 105UK	LO338 105UL	ø380	1050	5870	+440	15	0,17
LO350 50UK	LO350 50UL	ø500	500	6420	+580	16	0,16
LO350 55UK	LO350 55UL	ø500	550	6420	+580	16	0,16
Artno Skål inkl. planteringskårl Pelare blankkrom Bowl incl. planter Pedestal polish chromed	Artno Skål inkl. planteringskårl. Pelare lack. Bowl incl. planter Pedestal color	Diameter mm	Höjd Height	Skål Bowl SEK			
LOS60K	LOS60L	ø250	600	5210		15	0,10
LOS65K	LOS65L	ø250	650	5210		15	0,10
LOS100K	LOS100L	ø250	1000	5360		17	0,12
LOS115K	LOS115L	ø250	1150	5360		17	0,12
				Tillbehör Accessories SEK			
*LOF 20 lackad fot painted base foot		ø200		+1040			
LOF 25 lackad fot painted base		ø250		+1150			
LOK Krok blankkrom max 3st Hooks polished chrome max 3pcs				+150/3pcs			

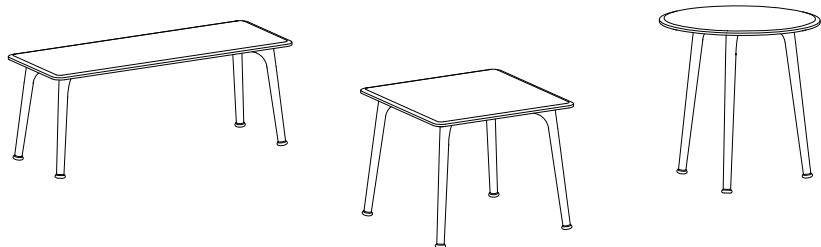

Utgående produkt med reservation för slutförsäljning.

Bord.

Skiva, tjocklek 22mm, och ben i massiv trä i ek, ask, standardbetser på ask och vitpigment på ek eller ask. Ytbehandling klarlack. Filtass är monterad under ben. Specialmått och andra utförande efter förfrågan. Bordet levereras omonterat. Benen skruvas fast under bordsskivan. Vid order ange höjd.

Outbound product with reservation for end of stock.

Table.

Table top, thickness 22mm, and leg in solid wood in oak, ash, standard stains on ash or white glazed on oak or ash. Finish clear lacquer. Felt floor protection under the legs. Special sizes of finishes upon request. The table comes unmounted. The legs screwed under the table top. When ordering state height.

Artno

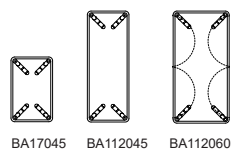

BA17045 BA112045 BA112060

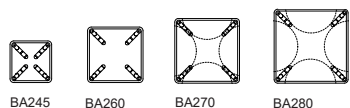

BA245 BA260 BA270 BA280

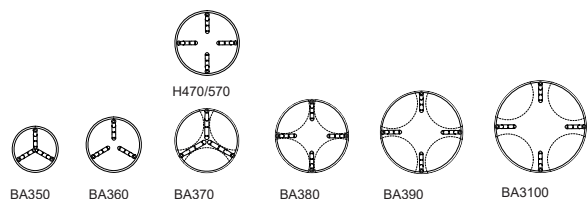

BA350 BA360 BA370 BA380 BA390 BA3100

H470/570

Bat SEK

Extra SEK

Artno	Längd Length mm	Bredd Width mm	Diameter mm	Höjd Height mm	.10 ek oak .30 ask ash	Standardbets på ask Standard stain on ash Vitpigment ek ask White glazed oak ash	Vikt netto Weight net kilos	Volym Volume net
Rektangulär Rectangulare								
BA17045	700	450		470,570	9950	+1510	7	0,04
BA112045	1200	450		470,570	11380	+1740	15	0,06
BA112060	1200	600		470,570	12420	+2010	18	0,08
BA112060	1200	600		720	13430	+2010	20	0,1
Kvadratisk Square								
BA245	450	450		470,570	9020	+1370	8	0,04
BA260	600	600		470,570	10250	+1550	10	0,05
BA270	700	700		470,50	11030	+1660	12	0,07
BA270	700	700		720	12070	+1660	14	0,0
BA280	800	800		470,50	11990	+1960	16	0,08
BA280	800	800		720	13000	+1960	18	0,1
Rund Round								
BA350			ø500	470,570	7940	+1190	7	0,04
BA360			ø600	470,570	8780	+1350	9	0,05
BA370 4ben/legs			ø700	470,570	11150	+1560	11	0,07
BA370 3ben/legs			ø700	720	10340	+1560	13	0,09
BA380			ø800	470,570	12020	+1970	14	0,08
BA380			ø800	720	13030	+1970	16	0,1
BA390			ø900	470,570	12800	+2100	15	0,0
BA390			ø900	720	13810	+2100	17	0,1
BA3100			ø1000	470,570	14130	+2290	18	0,1
BA3100			ø1000	720	15120	+2290	20	0,12

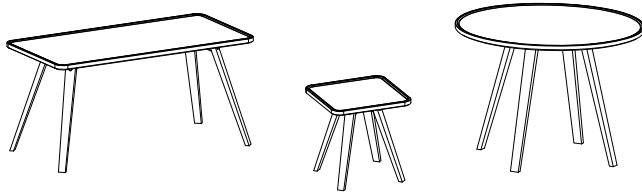

Bord.

Bordsskiva, tjocklek ca 28/23mm, och ben i massiv trä ek, björk, ask, standardfärger, standardbets på ask och vit pigment på ek eller ask. Bordsskiva i standardfärg/lack tillverkas i MDF. Ytbehandling klarlack. Specialmått och andra utförande efter förfrågan. Bordet levereras omonterat. Benen skruvas fast under bordsskivan. Vid order ange höjd.

Outbound product with reservation for end of stock.

Table.

Table top, thickness approx 28/23mm, and leg in solid wood of oak, birch, ash, standard colors, standard stains on ash and white glazed on oak or ash. Table top in standard colors are made in MDF. Specials sizes and other finishes upon request. The table comes unmounted. The legs are screwed under the table top. When ordering state height.

Artno

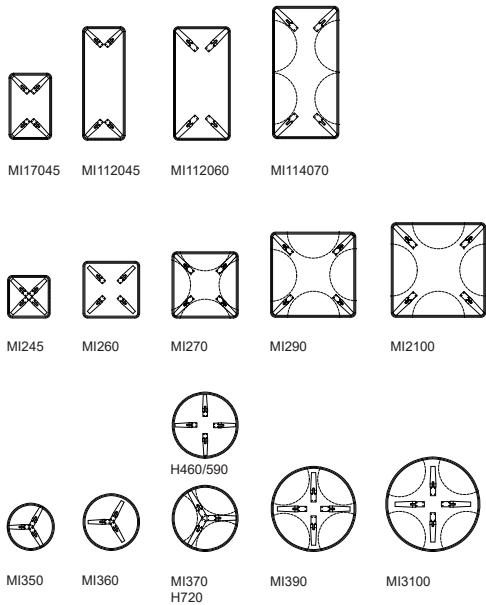

Artno	Längd Length mm	Bredd Width mm	Diameter mm	Höjd Height mm	MILL SEK		Extra SEK		
					.10 ek oak .20 björk birch .30 ask ash	.50 lack color	Standardbets på ask Standard stain on ash Vitpigment ek ask White glazed oak ash	Vikt netto Weight net kilos	Volym Volume net
Rektangulär Rectangulare									
MI17045	700	450		460,590	10430	9690	+1570	10	0,04
MI112045	1200	450		460,590	13300	11780	+1930	16	0,06
MI112060	1200	600		460,590	15250	13030	+2310	24	0,08
MI112060	1200	600		720	16170	14050	+2310	26	0,1
MI114070	1400	700		460,590	18620	15610	+2940	28	0,1
MI114070	1400	700		720	19590	16670	+2940	30	0,12
Kvadratisk Square									
MI245	450	450		460,590	8830	8510	+1280	8	0,04
MI260	600	600		460,590	11130	10300	+1580	12	0,05
MI270	700	700		460,590	12620	11320	+2080	15	0,06
MI270	700	700		720	13540	12380	+2080	17	0,08
MI290	900	900		460,590	16690	13980	+2640	24	0,08
MI290	900	900		720	17600	15050	+2640	26	0,1
MI2100	1000	1000		460,590	18560	15850	+2940	30	0,1
MI2100	1000	1000		720	19510	16890	+2940	32	0,12
Rund Round									
MI350			ø500	460	8220	7500	+1240	8	0,04
MI360			ø600	460,590	9790	8830	+1460	8	0,04
MI370 4ben/legs			ø700	460,590	12620	11320	+1800	15	0,06
MI370 3ben/legs			ø700	720	11990	10650	+1800	17	0,08
MI390			ø900	460,590	16690	13980	+2640	21	0,08
MI390			ø900	720	17600	15050	+2640	23	0,1
MI3100			ø1000	460,590	18560	15850	+2940	27	0,1
MI3100			ø1000	720	19510	16890	+2940	30	0,12

TERRANE Nestor Campus 2020



TN345 TN373

Utgående produkt med reservation för slutförsäljning.

Soffbord. Massiv trä, klarlack.
Bordet är försett med tassar.
Bordet levereras monterat.
Vid order ange höjd på bordet.

Outbound product with reservation for end of stock.

Sofa table. Solid wood, clear lacquer.
Legs included felt protection.
Table comes mounted.
State when ordering height of table.

Artno	Diameter mm	Höjd Height mm	Terrane SEK		Vikt netto Weight net kilos	Volym Volume net
			.10 ek oak .20 björk birch .30 ask ash	Standardbets på ask Standard stain on ash Vitpigment ek ask White glazed oak ash		
TN3 45331	ø450	330	5960	+880	5	0,09
TN3 45451	ø450	450	5960	+880	6	0,13
TN3 45571	ø450	570	5960	+880	6	0,16
TN3 73331	ø730	330	7270	+1090	12	0,22
TN3 73451	ø730	450	7270	+1090	13	0,3
TN3 73571	ø730	570	7270	+1090	13	0,33

EIGHT Louise Hederström 2018



EI24 EI46 EI62

Soffbord. Massiv trä, klarlack.

Vid lack är skivan MDF. Bordsskiva tjocklek ca 25mm.
Filttass.
Bord levereras monterat.

Sofa table. Solid wood, clear lacquer.

When lacquering top in MDF. Table top thickness approx 25mm.
Felt floor protection.
Table comes pre-assembled.

Artno	Längd Length mm	Bredd Width mm	Höjd Height mm	Eight SEK		Vikt netto Weight net kilos	Volym Volume net	
				.10 ek oak .20 björk birch .30 ask ash	.50 lack color			
EI24	352	352	530	5620	4950	+830	4	0,12
EI46	454	454	575	6240	5120	+930	4,5	0,17
EI62	600	600	480	7110	5290	+1080	7	0,19

PUDDLE Anton Björnsing 2017



PU510 PU520 PU530

Soffbord. Massiv trä, klarlack.

Vid lack är skivan MDF. Bordsskiva tjocklek ca 31/28mm.
Filttass.
Bordet levereras omonterat.
Vid order ange höjd på bordet.

Sofa table. Solid wood, clear lacquer.

When lacquering top in MDF. Table top thickness approx 31/28mm
Felt floor protection.
Table comes unmounted.
State when ordering height of table.

Artno	Längd Length mm	Bredd Width mm	Höjd Height mm	Puddle SEK		Vikt netto Weight net kilos	Volym Volume net	
				.10 ek oak .20 björk birch .30 ask ash	.50 lack color			
PU510	450	410	380,450,520,590	8900	8330	+1310	10	0,04
PU520	550	500	380,450,520,590	10130	8890	+1530	12	0,04
PU530	720	660	380,450,520,590	11500	9520	+1730	14	0,06

TRAYO Anton Björnsing 2019

Soff/Brickbord.

L = Metallstativ lackat i standardfärger.

M = Metallstativ mattkrom.

Tråringar formpressade i ek eller ask, standardbets på ask och vitpigmenterad ek, ask.

Runda skivor fanerad MDF i ek, ask, vit och svart laminat, standardbets på ask och vitpigmenterad på ek eller ask.

Tillbehör:

Handtag lindat i Tärnslö läder col. 8175 svart eller col. 8695 brun.

Dolda hjul 4 stycken som monteras i nedersta brickan, ej låsbara.

Ange vid beställning artikelnummer, utförande på ring, skiva och metallstativ.

Sofa/Tray table.

L = Metal frame painted in standard colors.

M = Metal frame in matt chrome.

The wooden rings are available in compression-moulded oak or ash, standard stains on ash and white-glazed oak or ash.

The round trays are in MDF, veneered with oak, ash, with white and black laminate, in standard stains on ash or white glazed oak or ash.

Accessories:

Concealed four castors that can be fitted to the lower tray, not lockable.

Handles wrapped in black (col. 8175) or brown (col. 8695) leather from Tärnslö.

When ordering please enter article number and choice of finish for ring, tray and metal frame.



TR340L
TR340M
ø400 H 450

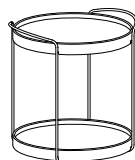

TR350L
TR350M
ø500 H 520

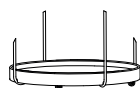

TRH
Hjul 4st ej låsbara, +H10mm
Castors 4pcs not lockable, +H10mm

Artno	Diameter mm	Höjd Height mm	Trayo SEK		Extra SEK		
			.10 ek oak .60 ek/vit laminat oak/white laminate .61 ek/svart laminat oak/black laminate	.30 ask ash .62 ask/vit laminat ash/white laminate .63 ask/svart laminat ash/black laminate	Standardbets på ask Standard stain on ash Vitpigment ek ask White glazed oak ash	Vikt netto Weight net kilos	Volym Volume net
Metallstativ lackat i standardfärger Metal frame painted in standard colors							
TR340L	ø400	450	8060	7120	+690	5	0,1
TR350L	ø500	520	9170	7950	+800	6	0,17
Metallstativ mattkrom Metal frame matt chrome							
TR340M	ø400	450	8060	7120	+690	5	0,1
TR350M	ø500	520	9170	7950	+800	6	0,17
Tillbehör Accessories							
			Tillbehör Accessories SEK				
TRH Hjul, ej låsbara Castors, not lockable		+10	+1680				
TRL40-1 Handtag svart läder ø400 Handle black leather ø400			+2550				
TRL40-2 Handtag brunt läder ø400 Handle brown leather ø400			+2550				
TRL50-1 Handtag svart läder ø500 Handle black leather ø500			+2870				
TRL50-2 Handtag i brunt läder ø500 Handle in brown leather ø500			+2870				

TRIO Ulla Christiansson 1998

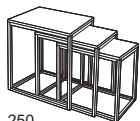

Satsbord. Massiv trä, klarlack.
Bord levereras monterat.

Nest of tables. Solid wood, clear lacquer.
Table comes pre-assembled.

250

Artno	Längd Length mm	Bredd Width mm	Höjd Height mm	Trio SEK		Extra SEK		Vikt netto Weight net kilos	Volym Volume net
				.10 ek oak .30 ask ash	.20 björk birch	Olja Oil	Olja+lack Oil+clear lacquer Standardbets på ask Standard stain on ash Vitpigment ek, ask White glazed oak or ash		
250	440/420/400	340/290/240	580/555/530	11500	10980	+1140	+1730	10	0,13

NEWTON Dan Sunaga Staffan Holm 2009



Soffbord. Glasskiva tjocklek ca8mm, triellips.
Underrede trä, klarlack. Underredet levereras monterat
och glasskivan ligger löst på underredet.

Sofa table. Glass top, thickness approx 8mm. Base in wood,
clear lacquer. The base comes pre-assembled and glass top is
loose on the base.

NW1597

NW2592

Artno	Diam mm	Höjd Height mm	Newton SEK		Extra SEK		Vikt netto Weight net kilos	Volym Volume net
			.10 ek oak	.20 björk birch .30 ask ash	Standardbets på ask Standard stain on ash Vitpigment ek ask White glazed oak ash			
NW1597	ø970	cirka approx ~ 300	15790	13580	+2010	25	0,35	
NW2592	ø920	cirka approx ~ 390	15420	13180	+1980	25	0,35	

HITO Mario Martinez 2024



HT3 4345

HT3 4455

HT3 4945

HT3 5055

Soffbord.

Skivan i massiv trä och underredet formpressad i ek, ask,
standardbets samt vitpigmenterad ek och ask.
Tillbehör är eluttag. Hito levereras monterat.

Sofa table.

The top in solid wood and the base molded in oak, ash,
standard stains and white-pigmented oak and ash.
Accessories are electrical outlets. Hito is delivered
assembled.

Artno	Diameter mm	Höjd Height mm	Hito SEK		Extra SEK		Vikt netto Weight net kilos	Volym Volume net
			.10 ek oak .30 ask ash	Standardbets på ask Standard stain on ash Vitpigment ek ask White glazed oak ash				
HT3 4345	430	450	7060		+1060	4	0,1	
HT3 4455	440	550	7060		+1060	5	0,13	
HT3 4945	490	450	7210		+1080	5	0,15	
HT3 5055	500	550	7210		+1080	5	0,17	
			Tillbehör Accessories SEK					
TKB11HT	57		920 svart black					
TKB19HT	57		1500 svart black					

Tillbehör Accessories



TKB11HT
Powerdot Mini. Placeras i pelare.1
eluttag. 1,5m kabel svart.
Gäller för SE,NO,FIN,DE,NL.
Powerdot Mini. Placed in the pillar
electrical outlet, 1,5m cable, black.
Only for SE,NO,FIN,DE,NL



TKB19HT
Powerdot Mini. Placeras i pelare.
USB C laddare, 2 portar 1,25m kabel
svart. Gäller för SE,NO,FIN,DE,NL.
Powerdot Mini. Placed in the pillar,
USB C charger 2 ports, 1,25m cable,
black. Only for SE,NO,FIN,DE,NL.

SHELL PALL STOOL

Note 2015  Möbelfakta

SHPxxT

Träsits. Ben i massiv trä, klarlack. Filttass.

SHPxxT

Wooden seat. Legs in solid wood, clear lacquer. Felt floor protection.

SHPxxK

Klädd sits. Ben i massiv trä, klarlack. Filttass.
Staffiad prisskala avser samma färg på tyg och träslag.
För mönsterpassat tyg återkom för prisuppgift.

SHPxxK

Seat upholstered. Legs in solid wood, clear lacquer. Felt floor protection.
Staffed price scale refers to the same color of fabric and wood.
For patterned fabric returned for price information.

Artno



SHP45T
SHP45K

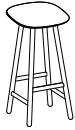

SHP70T
SHP70K



SHP80T
SHP80K

Artno	Bredd Width mm	Djup Depth mm	Höjd Height mm	Shell pall stool SEK		Extra SEK		
				.10 ek oak .20 björk birch .30 ask ash	.50 lack color	Standardbets på ask Standard stain on ash	Vikt netto Weight net kilos	Volym Volume net
Träsits Wooden seat						Vitpigment ek ask White glazed oak ash		
SHP45T	370	413	450	4850	5320	+740	2,4	0,1
SHP70T	370	413	650	5200	5680	+790	2,8	0,15
SHP80T	370	413	800	5520	6030	+820	3,3	0,18

Artno	Bredd Width mm	Djup Depth mm	Höjd Height mm	Shell pall stool SEK						Extra SEK			
				.10 ek oak .20 björk birch .30 ask ash	.10 ek oak .20 björk birch .30 ask ash	.10 ek oak .20 björk birch .30 ask ash	.50 lack color	.50 lack color	.50 lack color	Standardbets på ask Standard stain on ash	Tygåtgång på 140 cm bredd Requirement of fabric width 140 cm	Vikt netto Weight net kilos	Volym Volume net
Klädd sits exkl. tyg eller läder Upholstered seat excl. fabric or leather				1 styck pc	2-10 styck pc	11- styck pc	1 styck pc	2-10 styck pc	11- styck pc	per styck pc			
SHP45K	370	413	450	5900	5360	5120	6760	5660	5510	+700	50x90 cm	2,4	0,1
SHP70K	370	413	650	6220	5670	5460	7120	6030	5900	+750	50x90 cm	2,8	0,15
SHP80K	370	413	800	6520	5990	5790	7480	6360	6220	+800	50x90 cm	3,3	0,18

Extra Tyg Läder, Fabric Leather

SEK/styck pc	1 styck pc	2-10 styck pcs	11- styck pcs
Prisgrupp Pricegroup 1	+1240	+940	+690
Prisgrupp Pricegroup 2	+1430	+1120	+870
Prisgrupp Pricegroup 3	+1620	+1310	+1060
Prisgrupp Pricegroup 4	+1800	+1500	+1250
Standard läder leather	1120	+1120	+1120

MLPxxTTF Sits och ben i massiv trä, klarlack. Filttass.

MLPxxTTFR Rygg i trä. Sits och ben i massiv trä, klarlack. Filttass.

MLPxxTKF Klädd dyna. Sits och ben i massiv trä, klarlack. Filttass.

MLPxxTKFR Rygg i trä. Klädd dyna. Sits och ben i massiv trä, klarlack. Filttass

Alla pallar är försedd med snurrfunktion, max 130kg.

Stafflad prisskala avser samma färg på tyg och träslag. För mönsterpassat tyg återkom för prisuppgift.

MLPxxTTF Seat and legs in solid wood, clear lacquer. Felt floor protection.

MLPxxTTFR Back in wood. Seat and legs in solid wood, clear lacquer. Felt floor protection.

MLPxxTKF Cushion upholstred. Seat and legs in solid wood, clear lacquer. Felt floor protection.

MLPxxTKFR Back in wood. Cushion upholstred. Seat and legs in solid wood, clear lacquer. Felt floor protection.

All stools included swivel, max 130 kilos.

Staffed price scale refers to the same color of fabric and wood. For patterned fabric returned for price information.

Artno



MLP65 TTF H650
MLP75 TTF H750



MLP65 TTFR SH650
MLP75 TTFR SH750



MLP65 TKF H650
MLP75 TKF H750



MLP65 TKFR SH650
MLP75 TKFR SH750



Pallar är försedd med snurrfunktion, max 130 kg
Stools included swivel, max 130 kilos

Tillbehör Accessories



Fotplåt Foot rest

Artno	Bredd Width mm	Djup Depth mm	Höjd Height mm	Sithöjd Seat height mm	Milo SEK		Extra SEK			Vikt netto Weight net kilos	Volym Volume net
					.10 ek oak .30 ask ash	Standardbets på ask Standard stain on ash Vitpigment ek ask White glazed oak ash	Fotplåt Foot rest MLPFPs = svart black MLPFPv = vit white	Fotplåt Foot rest MLPFPr = rostfri stål stainless steel			
Träsits Wooden seat											
MLP65 TTF	350	350 ø390	650		5750	+870	+600	+750		6	0,12
MLP75 TTF	350	350 ø390	750		5820	+870	+600	+750		6	0,17
Rygg. Träsits. Back. Wooden seat.											
MLP65 TTFR	350	350 ø390/370	870	650	7760	+1150	+600	+750		7	0,15
MLP75 TTFR	350	350 ø390/370	970	750	7820	+1150	+600	+750		7	0,20

Artno	Bredd Width mm	Djup Depth mm	Höjd Height mm	Sithöjd Seat height mm	Milo SEK			Extra SEK			Tygåtgång på 140 cm bredd Requirement of fabric width 140 cm	Vikt netto Weight net kilos	Volym Volume net
					.10 ek oak .30 ask ash	.10 ek oak .30 ask ash	.10 ek oak .30 ask ash	Standardbets på ask Standard stain on ash Vitpigment ek ask White glazed oak ash	Fotplåt Foot rest MLPFPs = svart black MLPFPv = vit white	Fotplåt Foot rest MLPFPr = rostfri stål stainless steel			
Klädd dyna exkl. tyg eller läder Upholstred cushion excl. fabric or leather													
MLP65 TKF	350	350 ø390	650		6850	6800	6660	+870	+600	+750	50 cm	6	0,12
MLP75 TKF	350	350 ø390	750		6930	6850	6710	+870	+600	+750	50 cm	6	0,17
Rygg. Klädd dyna exkl. tyg eller läder Back. Upholstred cushion, excl. fabric or leather													
MLP65 TKFR	350	350 ø390/370	870	650	8860	8780	8640	+1150	+600	+750	50 cm	7	0,15
MLP75 TKFR	350	350 ø390/370	970	750	8930	8860	8730	+1150	+600	+750	50 cm	7	0,20

Extra Tyg Läder, Fabric Leather

SEK/styck pc	1 styck pc	2-10 styck pcs	11- styck pcs
Prisgrupp Pricegroup 1	+1240	+620	+400
Prisgrupp Pricegroup 2	+1430	+720	+500
Prisgrupp Pricegroup 3	+1620	+810	+610
Prisgrupp Pricegroup 4	+1800	+900	+710
Standard läder leather	+480	+480	+480

Pall
Sits i massiv trä, klarlack. Ben i metall, ytbehandling i
*mattkrom eller **svartlack. Filttass.

Stool
Seat in solid wood, clear lacquer. Legs in metal, finish
*mattchrome or **black lacquer. Felt floor protection.

Artno



KAZP45M* KAZP45S** KAZP65M* KAZP65S** KAZP80M* KAZP80S**

Artno	Bredd Width mm	Djup Depth mm	Höjd Height mm	Kaz SEK		Vikt netto Weight net kilos	Volym Volume net
				.10 ek oak .30 ask ash	Standardbets på ask Standard stain on ash Vitpigment ek, ask White glazed oak, ash		
KAZP45M	440	365	450	4710	+400	4	0,1
KAZP45S	440	365	450	4710	+400	4	0,1
KAZP65M	440	405	650	5080	+400	5	0,15
KAZP65S	440	405	650	5080	+400	5	0,15
KAZP80M	440	405	800	5240	+400	6	0,18
KAZP80S	440	405	800	5240	+400	6	0,18

T.I.P. Simon Bågstad 2026

T.I.P. är en praktisk liten pall eller soffbord med några få komponenter som kan monteras med bara händerna och en träklubba. Det är en traditionell kil-konstruktion som håller ihop sitsen/skivan med benen, där kilen i sig blir en detalj som ger pallen/bordet en unik identitet. T.I.P. står för Tradition. Innovation. Purpose.

T.I.P. är tillverkad av trävirke som har blivit över i vår möbeltillverkning. Det kan vara ytträets ljusa inslag och kärnans mörka som kombineras i breda och smala lameller som ger sitsen/skivan sin unika mönstring och karaktär. Det är Bosse och Kent som kapar plank och bräder hos oss och som bestämmer vilket virke som ska användas. Varje pall/bord blir därmed helt unik och visar helt enkelt träet som det är. Pallen finns med träsis eller klädd sittdyna. Träslag ek, ask, standardbets på ask eller vitpigment på ek eller ask, där stolsitsen består av lameller i massivt trä. Kilen är gjord i massiv wenge som är ett restmaterial som har legat på lager hos oss under många år. Ytbehandlingen är klarlack eller linolja.

Vi erbjuder även pallsitsen/bordsskivan, med sina lameller, i slumpvist blandat utförande där våra snickare blandar ett mörkt träslag med ask eller ek (ben i ek, ask, standardbets, vitpigment ek eller ask). Det kan vara wenge, körsbär, värmebehandlat massivträ eller något annat träslag beroende på det som finns på våra hyllor. Se bilder nedan.

T.I.P. is a practical small stool or sofa table with a few components that can be assembled with just your hands and a wooden mallet. It is a traditional wedge construction that holds the seat/top and legs together, where the wedge itself becomes a detail that gives the stool a unique identity. T.I.P. stands for Tradition. Innovation. Purpose.

It is made of wood that has been left over from our furniture manufacturing. It can be the light elements of the surface wood and the dark of the core that are combined in wide and narrow slats that give the seat its unique pattern and character. It is Bosse and Kent, who cuts the planks and boards, who decides which wood to use. Each stool/table is therefore completely unique and simply shows the wood as it is. If you want to hide it, the stool is also available with an upholstered seat. T.I.P. is made of oak, ash, standard stains on ash or white pigment on oak or ash, where the chair seat consists of slats in solid wood. The wedge is made of solid wenge which is a residual material that has been in our warehouse for many years. The surface finish is clear varnish or linseed oil. We also offer the seat/top, with its slats, in a randomly mixed design where our carpenters mix a dark wood with ash or oak, (legs in oak, ash, standard stains or white pigment oak or ash). It can be wenge, cherry, heat-treated solid wood or any other wood type depending on what is on our shelves. See photo below.

Artno



TIPP46T TIPP46K Blandat trä på sits/skiva
Mixed wood seat/top

Artno	Diam mm	Höjd Height mm	T.I.P. SEK			Extra SEK				
			.10 ek oak .30 ask ash	.10 ek oak .30 ask ash	.10 ek oak .30 ask ash	Standardbets på ask Standard stain on ash Vitpigment ek ask White glazed oak ash	Blandat trä Mixed wood	Tygåtgång på 140 cm bredd Requirement of fabric width 140 cm	Vikt netto Weight net kilos	Volym Volume net
Träsits/skiva Wooden seat/top										
TIPP46T	315	460	3370	-----	-----	+340	+340	----	4	0,05
Klädd dyna exkl. tyg Upholstered cushion excl. fabric			1styck pc	2-10 styck pcs	11- styck pcs					
TIPP46K	315	480	4430	4380	4240	+340	---	50 cm	4	0,05

Extra Tyg Läder, Fabric Leather artno TIPP46K

SEK/styck pc	1 styck pc	2-10 styck pcs	11- styck pcs
Prisgrupp Pricegroup 1	+1240	+620	+400
Prisgrupp Pricegroup 2	+1430	+720	+500
Prisgrupp Pricegroup 3	+1620	+810	+610
Prisgrupp Pricegroup 4	+1800	+900	+710
Standard läder leather	+480	+480	+480

COLO CHAIR kaschkasch 2022

Den flexibla och fällbara stolen Colo Chair är stativet i massivt trä med formpressad sits och rygg i trä. Samtliga beslag är i rostfritt stål. Träsäten är ek, ask, standardbetser på ask och vitpigmenterad ek eller ask. Benen är försedd med filtassar. Som tillval finns klädd dyna i tyg eller läder, kopplingsbeslag och upphängningsbeslag i massivträ lika utförande som stolen. Maxantal två stycken per upphängningsbeslag. Transportvagn med låsbara hjul och metallhandtag i svart finns för 12 stolar. I hopfällt läge är staplingsmättet är 72 mm. Med hjälp av handverktyg är det enkelt att separera alla delar av stolen.

The flexible and folding Colo Chair is made in solid wood frame supports a compression-pressed wooden seat and backrest. All fittings are made of stainless steel. Choose from oak or ash, standard stains on ash, or white glaze on oak or ash. The legs have felt floor protectors. Optional extras are seat pads covered in fabric or leather, link fittings and solid wood suspension brackets in the same finish as the chair. Maximum two chairs per bracket. A trolley in a black finish with metal handles and locking wheels is also available for storing and transporting up to 12 chairs. Each chair folds to a maximum of 72 mm. The appropriate hand tools are all that is required to simply separate each chair into its component parts.

Mått ihopfälld Dimension folded

Tillbehör Accessories



CC1



CC2

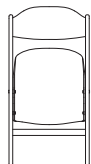

W 458
CC1 - D 81
CC2 - D 98
H 917



CCU2
D160 ø38
Upph.beslag max 2 stolar
Suspen.bracket max. 2 chairs



CCK
Koppl.beslag distans 40mm
rostfri
Link fittings distance 40mm
stainless

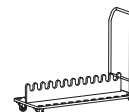

CCV1
Vagn max 12 stolar, svart
Trolley max 12 chairs, black

Artno	Colo Chair SEK					Extra SEK		Vikt netto Weight net kilos	Volym Volume net
	Bredd Width mm	Djup Depth mm	Höjd Height mm	Sitthöjd Seat Height mm	.10 ek oak	.30 ask ash	Standardbets på ask Standard stain on ash		
Träsits Wooden seat							Vitpigment ek ask White glazed oak ash		
CC1	460	540	815	465	4740	4470	+660	3,4	0,05
Tillbehör Accessories for CC1 and CC2									
CCU2		160/ø38			580	580	80		
CCK rostfri stainless	40				370 rostfri stainless				
CCV1 svart black	500	1250	1015		7290 svart black			18	

Artno	Colo Chair SEK									Extra SEK		Vikt netto Weight net kilos	Volym Volume net	
	Bredd Width mm	Djup Depth mm	Höjd Height mm	Sitthöjd Seat Height mm	.10 ek oak	.10 ek oak	.10 ek oak	.30 ask ash	.30 ask ash	.30 ask ash	Standardbets på ask Standard stain on ash			Tygåtgång på 140 cm bredd Requirement of fabric width 140 cm
Klädd sits exkl. tyg eller läder Upholstred seat excl. fabric or leather					1 pc	2-10 pc	11- pc	1 pc	2-10 pc	11- pc	per styck pc			
CC2	460	540	815	480	6020	5980	5860	5740	5710	5580	+660	50x45 cm	4,3	0,06

Extra Tyg Läder, Fabric Leather

SEK/styck pc	1 styck pc	2-10 styck pcs	11- styck pcs
Prisgrupp Pricegroup 1	+1240	+620	+290
Prisgrupp Pricegroup 2	+1430	+720	+360
Prisgrupp Pricegroup 3	+1620	+810	+420
Prisgrupp Pricegroup 4	+1800	+900	+490
Standard läder leather	+620	+620	+620

SHELL STOL CHAIR Note 2018

Möbelfakta

SHST45T träsis.

Ben i massiv trä, klarlack inkl. filltass.

SHST45S klädd sits.

Ben i massiv trä, klarlack inkl. filltass.
Stafflad prisskala avser samma färg på tyg och träslag.
För mönsterpassat tyg återkom för prisuppgift.

SHST45K klädd sits och rygg.

Ben i massiv trä, klarlack inkl. filltass.
Stafflad prisskala avser samma färg på tyg och träslag.
För mönsterpassat tyg återkom för prisuppgift.

SHST45T wooden seat

Legs in solid wood incl. felt floor protection. Clear lacquer.

SHST45S covered seat

Legs in solid wood incl. felt floor protection. Clear lacquer.
Staffed price scale refers to the same color of fabric and wood.
For patterned fabric returned for price information.

SHST45K fully upholstered

Legs in solid wood incl. felt floor protection. Clear lacquer.
Staffed price scale refers to the same color of fabric and wood.
For patterned fabric returned for price information.

Artno



SHST45T



SHST45S



SHST45K

Shell stol chair SEK

Extra SEK

Artno	Bredd Width mm	Djup Depth mm	Höjd Height mm	Sithöjd Seat Height mm	.10 ek oak	.20 björk	.50 lack color	Standardbets på ask Standard stain on ash	Vikt netto Weight net kilos	Volym Volume net
					.30 ask ash	birch				
Träsits Wooden seat										
SHST45T	405	525	825	460	5980	5320	5800	+880	4	0,28

Shell stol chair SEK

Extra SEK

Artno	Bredd Width mm	Djup Depth mm	Höjd Height mm	Sithöjd Seat Height mm	.10 ek oak	.10 ek oak	.10 ek oak	.20 björk	.20 björk	.20 björk	.50 lack color	.50 lack color	.50 lack color	Standardbets på ask Standard stain on ash	Tygätgång på 140 cm bredd Requirement of fabric width 140 cm	Vikt netto Weight net kilos	Volym Volume net
					.30 ask ash	.30 ask ash	.30 ask ash	birch	birch	birch	color	color	color				
Klädd sits exkl. tyg eller läder Upholstred seat excl. fabric or leather																	
					1 pc	2-10 pc	11- pc	1 pc	2-10 pc	11- pc	1 pc	2-10 pc	11- pc	per styck pc			
SHST45S	405	525	825	475	7470	7420	7260	6800	6740	6610	7270	7240	7090	+880	50x46 cm	5	0,28
Klädd sits och rygg exkl. tyg eller läder Fully upholstred excl. fabric or leather																	
SHST45K	405	525	825	470	9070	7610	7370	8930	7480	7250	9200	7770	7540	+380	75 cm	4	0,28

Extra Tyg Läder, Fabric Leather

SHST45S klädd sits upholstred seat

SEK/styck pc	1 styck pc	2-10 styck pcs	11- styck pcs
Prisgrupp Pricegroup 1	+1240	+620	+290
Prisgrupp Pricegroup 2	+1430	+720	+360
Prisgrupp Pricegroup 3	+1620	+810	+420
Prisgrupp Pricegroup 4	+1800	+900	+490
Standard läder leather	+620	+620	+620

Extra Tyg Läder, Fabric Leather

SHST45K klädd sits och rygg fully upholstred

SEK/styck pc	1 styck pc	2-10 styck pcs	11- styck pcs
Prisgrupp Pricegroup 1	+1550	+1250	+1000
Prisgrupp Pricegroup 2	+1840	+1530	+1280
Prisgrupp Pricegroup 3	+2120	+1810	+1560
Prisgrupp Pricegroup 4	+2400	+2090	+1840
Standard läder leather	+2560	+2560	+2560

Stol staplingsbar.

Taverna finns med sits i trä eller klädd dyna i tyg eller läder.

Gemensamt är att den tillverkas i träslagen ek, ask, standardbets, vitpigmenterade ek och ask samt att foten är försedd med filltass.

TVS46T - Träsits

Sits är försedd med staplingskydd och kan stapla upp till sex stolar.

Tillval: ljudabsorbent under sitsen.

TVS46K - Klädd sits

Stolen kan staplas upp till fem stolar.

Ljudabsorbent under sitsen ingår.

Båda stolarna levereras monterad. Sitsen är lätt att skruva av och byta vid eventuell skada eller för omklädning. Vid beställning ange artikelnummer, utförande och ev. klädsel för klädd dyna.

Chair stackable.

Taverna is available with a wooden seat or upholstered cushion in fabric or leather.

What they have in common is that it is manufactured in oak, ash, standard stains, white-pigmented oak and ash and that the foot is equipped with a felt paw.

TVS46T - Wooden seat

Seat is equipped with stacking protection and can be stacked up to six chairs.

Optional: sound absorber under the seat.

TVS46K - Upholstered seat

The chair can be stacked up to five chairs.

Sound absorber under the seat is included.

Both chairs are delivered assembled. The seat is easy to unscrew and replace in case of damage or for changing fabric. When ordering, state the article number, finish and fabric/leather for upholstered seat.

Artno



TVS46T



TVS46K



6 x TVS46T maximum



5 x TVS46K maximum

Artno	Bredd Width mm	Djup Depth mm	Höjd Height mm	Sithöjd Seat Height mm	Taverna SEK		Extra SEK		
					.10 ek oak .30 ask ash	Standardbets på ask Standard stain on ash	Ljudabsorbent under sits Sound absorber under seat	Vikt netto Weight net kilos	Volym Volume net
Träsits Wooden seat						Vitpigment ek ask White glazed oak ash			
TVS46T	520	500	790	460	6310	+630	+190	5	0,25

Artno	Bredd Width mm	Djup Depth mm	Höjd Height mm	Sithöjd Seat Height mm	Taverna SEK			Extra SEK			
					.10 ek oak .30 ask ash	.10 ek oak .30 ask ash	.10 ek oak .30 ask ash	Standardbets på ask Standard stain on ash	Tygåtgång på 140 cm bredd Requirement of fabric width 140 cm	Vikt netto Weight net kilos	Volym Volume net
Klädd sits inkl. ljudabsorbent under sits, exkl. tyg eller läder Upholstered seat incl. sound absorber under seat excl. fabric or leather					1 pc	2-10 pc	11- pc	per styck pc			
TVS46K	520	500	790	470	6780	6580	6480	+580	50cm	5	0,25

Extra Tyg Läder, Fabric Leather klädd sits upholstered seat

SEK/styck pc	1 styck pc	2-10 styck pcs	11- styck pcs
Prisgrupp Pricegroup 1	+1240	+620	+400
Prisgrupp Pricegroup 2	+1430	+720	+500
Prisgrupp Pricegroup 3	+1620	+810	+610
Prisgrupp Pricegroup 4	+1800	+900	+710
Standard läder leather	+620	+620	+620

Utgående produkt med reservation för slutförsäljning.

Pall.

Underrede och ben i massiv trä inkl. fittassar. Ytbehandling klarlack.
 Stoppning kallskum klädd exkl. tyg/läder. Tillbehör bord diam 260mm.
 Pall levereras monterad. Vid beställning ange artikelnummer, utförande och klädsel.

Outbound product with reservation for end of stock.

Stool.

Base in solid wood incl. felt protection. Finish clear lacquer.
 Upholstered excl. fabric/leather. Seat in cold-cured foam.
 The stool comes pre-assembled. When ordering article number, execution and name of fabric/leather.

Artno



HY370



HY390



HY3120

Tillbehör / Accessories



Bord Table diam 260mm
 Antal bord per pall/artno
 Numbers of table per stool/art.no

HY370-1 = 1st pc HY370
 HY390-1 = 1st pc HY390
 HY390-2 = 2st pc HY390
 HY3120-1 = 1st pc HY3120
 HY3120-2 = 2st pc HY3120
 HY3120-3 = 3st pc HY3120
 HY3120-4 = 4st pc HY3120

Hygge SEK	Extra SEK
-----------	-----------

Artno	Diam mm	Höjd Height mm	.10 ek oak .30 ask ash	Standardbets på ask Standard stain on ash Vitpigment ek ask White glazed oak ash	Tyg Fabric Prisgrupp Pricegroup 1	Tyg Fabric Prisgrupp Pricegroup 2	Tyg Fabric Prisgrupp Pricegroup 3	Tyg Fabric Prisgrupp Pricegroup 4	Standard läder Leather	Tygåtgång på 140 cm bredd Requirement of fabric width 140 cm	Vikt brutto Weight gross kilos	Volym Volume net
HY370	780/700	460	11900	+1790	+1740	+2080	+2420	+2750	+1850	90 cm	35	0,45
HY390	980/900	460	13190	+1980	+1990	+2400	+2820	+3230	+2440	110 cm	55	0,8
HY3120	1280/1200	460	14890	+2240	+2370	+2890	+3420	+3940	+4680	140 cm	70	1,09
	Tillbehör Accessories											
HY370-1	Bord Table diam 260	680	2270	+230								
HY390-1	Bord Table diam 260	680	2270	+230								
HY390-2	Bord Table diam 260	680	4530	+450								
HY3120-1	Bord Table diam 260	680	2270	+230								
HY3120-2	Bord Table diam 260	680	4530	+450								
HY3120-3	Bord Table diam 260	680	6810	+690								
HY3120-4	Bord Table diam 260	680	9070	+890								

Sander Conference

Träslag: ek, ask, standardbetser på ask och vitpigmenterad ek eller ask.

Underrede: Ben i massiv trä inkl. filttass.

4-kryssfot i metall i färg svart pulverlack eller polerad, sits alltid hög- och sänkbar och snurrbar. Filttass för hårda ytor eller plaststass för mjuka ytor

Fyra hjul ej låsbara, i färg svart pulverlack eller mattpolerad. Är snurrbar och välj mellan fast eller hög- och sänkbar sits.

Fåtölj finns med eller utan armstöd. Armstöd i massivt trä.

Fåtöljen levereras monterad. Med hjälp av handverktyg är det enkelt att separera ryggskaet från benstativ och vid en eventuell omklädning skruvas sits och rygg snäpps enkelt bort.

Ange vid beställning: artikelnummer, utförande på trä, tyg, läder samt tass för metallstativ.

Sander Conference

Wood: oak, ash, standard stains on ash and white glazed on oak or ash.

Base: Legs in solid wood incl. felt feet.

4-star base in metal, color black powder coating or polished, equipped with felt feet for hard surfaces or plastic feet for soft surfaces. Adjustable height and swivel.

Four wheels stand (not lockable). in black powder coating or matte polished. All chairs are swivel and choose between a fixed or adjustable height.

Sander Conference available with or without armrest. Armrest in solid wood

The seat and back may be covered in a fabric of choice or real or synthetic leather, according to customer wishes.

Fabrics should generally be somewhat stretchable. Avoid striped/checkered patterns. A removable seat cover with an interliner of hospital-grade fabric or lining cloth is available as an optional extra, recommendation is to choose a fabric that is washable and stretchable. The easy chair is supplied assembled. Hand tools are all that is needed to simply detach the back shell from the leg frame. It is a simple matter to separate seat and back, if the chair is to be re-covered.

State when ordering: article number, finish of wood, fabric, leather and feet on the 4-star base.

Arno Sander Conference



SAF500
Klädd sits.
Upholstered seat.



SAF504s = black
SAF504p = matt polished
Klädd sits, höj/sänkbar.
Upholstered seat, adjustable height.



SAF506s = black
SAF506p = matt polished
Klädd sits, fast höjd.
Upholstered seat, fixed height.



SAF508s = black
SAF508p = matt polished
Klädd sits, höj/sänkbar.
Upholstered seat, adjustable height.



SAF600
Klädd sits
Upholstered seat



SAF604s = black
SAF604p = matt polished
Klädd sits, höj/sänkbar.
Upholstered seat, adjustable height



SAF606s = black
SAF606p = matt polished
Klädd sits, fast höjd
Upholstered seat, fixed height



SAF608s = black
SAF608p = matt polished
Klädd sits, höj/sänkbar
Upholstered seat, adjustable height



SAF510
Klädd sits och rygg.
Upholstered seat and back.



SAF514s = black
SAF514p = matt polished
Klädd sits och rygg, höj/sänkbar.
Upholstered seat and back, adjustable height.



SAF516s = black
SAF516p = matt polished
Klädd sits och rygg, fast höjd.
Upholstered seat and back, fixed height



SAF518s = black
SAF518p = matt polished
Klädd sits och rygg, höj/sänkbar
Upholstered seat and back, adjustable height.



SAF610
Klädd sits och rygg.
Upholstered seat and back.



SAF614s = black
SAF614p = matt polished
Klädd sits och rygg, höj/sänkbar
Upholstered seat and back, adjustable height.



SAF616s = black
SAF616p = matt polished
Klädd sits och rygg, fast höjd.
Upholstered seat and back, fixed height.



SAF618s = black
SAF618p = matt polished
Klädd sits och rygg, höj/sänkbar.
Upholstered seat and back, adjustable height.

Extra Tyg Läder, Fabric Leather

Klädd sits Upholstered seat

Artno SAF500, SAF504, SAF506, SAF508, SAF600, SAF604, SAF606. SAF608

SEK/styck pc	1 styck pc	2-10 styck pcs	11- styck pcs
Prisgrupp Pricegroup 1	+1490	+750	+540
Prisgrupp Pricegroup 2	+1750	+880	+680
Prisgrupp Pricegroup 3	+2020	+1010	+820
Prisgrupp Pricegroup 4	+2280	+1140	+970
Standard läder leather	+1040	+1040	+1040

Extra Tyg Läder, Fabric Leather

Klädd sits och rygg Upholstered seat and back

Artno SAF510, SAF514, SAF516, SAF518, SAF610, SAF614, SAF616, SAF618

SEK/styck pc	1 styck pc	2-10 styck pcs	11- styck pcs
Prisgrupp Pricegroup 1	+1490	+1190	+940
Prisgrupp Pricegroup 2	+1750	+1450	+1200
Prisgrupp Pricegroup 3	+2020	+1710	+1460
Prisgrupp Pricegroup 4	+2280	+1970	+1720
Standard läder leather	+2040	+2040	+2040

Artno	Bredd Width mm	Djup Depth mm	Höjd Height mm	Sithöjd Seat height mm	Armstöd Armrest höjd height mm	Sander Conference SEK			Extra SEK						
						.10 ek oak .30 ask ash	.10 ek oak .30 ask ash	.10 ek oak .30 ask ash	Standardbets på ask Standard stain on ash Vitpigment ek ask White glazed oak ash	Avtagbar klädsel på sits, urinröv Removable cover on seat, an interliner of hospital-grade	Avtagbar klädsel på sits, domestik Removable cover on seat, lining cloth	Tygåtgång på 140 cm bredd Requirement of fabric width 140 cm	Höj-sänkbar sits Adjustable seat	Vikt netto Weight net kilos	Volym Volume net
utan armstöd excl. armrest						1 styck pc	2-10 styck pcs	11- styck pcs	per styck each	per styck each	per styck each				
SAF500	550	640	820	470		10720	10490	10350	+1270	+1120	+990	70 cm	---	9	0,34
SAF504s	550	640	800/925	415/540		11600	11360	11230	+1030	+1120	+990	70 cm	YES	14	0,33
SAF504p	550	640	800/925	415/540		11800	11580	11430	+1030	+1120	+990	70 cm	YES	14	0,33
SAF506s	550	640	850	460		11700	11470	11340	+1030	+1120	+990	70 cm	---	14	0,35
SAF506p	550	640	850	460		12120	11890	11750	+1030	+1120	+990	70 cm	---	14	0,35
SAF508s	550	640	840/965	460/585		11700	11470	11340	+1030	+1120	+990	70 cm	YES	14	0,35
SAF508p	550	640	840/965	460/585		12120	11890	11750	+1030	+1120	+990	70 cm	YES	14	0,35
SAF510	550	640	820	470		12970	12620	12380	+1030	+1120	+990	70 cm	---	9	0,34
SAF514s	550	640	800/925	415/540		13830	13490	13240	+980	+1120	+990	70 cm	YES	14	0,33
SAF514p	550	640	800/925	415/540		14050	13700	13450	+980	+1120	+990	70 cm	YES	14	0,33
SAF516s	550	640	850	460		13960	13590	13350	+980	+1120	+990	70 cm	---	14	0,35
SAF516p	550	640	850	460		14360	14010	13770	+980	+1120	+990	70 cm	---	14	0,35
SAF518s	550	640	840/965	460/585		13960	13590	13350	+980	+1120	+990	70 cm	YES	14	0,35
SAF518p	550	640	840/965	460/585		14360	14010	13770	+980	+1120	+990	70 cm	YES	14	0,35
med armstöd incl. armrest															
SAF600	600	640	820	470	615	11770	11530	11400	+1320	+1120	+990	70 cm	---	10	0,34
SAF604s	600	640	800/925	415/540	560/685	12640	12410	12260	+1090	+1120	+990	70 cm	YES	15	0,33
SAF604p	600	640	800/925	415/540	580/685	12830	12620	12470	+1090	+1120	+990	70 cm	YES	15	0,33
SAF606s	600	640	850	460	605	12200	11970	11840	+1090	+1120	+990	70 cm	---	15	0,35
SAF606p	600	640	850	460	605	13170	12940	12790	+1090	+1120	+990	70 cm	---	15	0,35
SAF608s	600	640	840/965	460/585	605/730	12750	12520	12390	+1090	+1120	+990	70 cm	YES	15	0,35
SAF608p	600	640	840/965	460/585	605/730	13170	12940	12790	+1090	+1120	+990	70 cm	YES	15	0,35
SAF610	600	640	820	470	615	14010	13640	13420	+1090	+1120	+990	70 cm	---	10	0,34
SAF614s	600	640	800/925	415/540	560/685	14880	14530	14290	+1030	+1120	+990	70 cm	YES	15	0,33
SAF614p	600	640	800/925	415/540	560/685	15090	14730	14500	+1030	+1120	+990	70 cm	YES	15	0,33
SAF616s	600	640	850	460	605	14990	14640	14390	+1030	+1120	+990	70 cm	---	15	0,35
SAF616p	600	640	850	460	605	15410	15060	14820	+1030	+1120	+990	70 cm	---	15	0,35
SAF618s	600	640	840/965	460/585	605/730	14990	14640	14390	+1030	+1120	+990	70 cm	YES	15	0,35
SAF618p	600	640	840/965	460/585	605/730	15410	15060	14820	+1030	+1120	+990	70 cm	YES	15	0,35

Pris Tyg Läder | Price Fabric Leather see page 90

SANDER LOUNGE Roger Persson 2021

Sander Lounge

Träslag: ek, ask, standardbetser på ask och vitpigmenterad ek eller ask.

Underrede: Ben i massiv trä inkl. filltass. 4-Kryssfot i metall, färg svart pulverlack eller polerad, är snurrbar och har återgång av sits. (Ej hög- och sänkbar). Kryssfot är försedd med filltass för hårda ytor eller plasttass för mjuka ytor. Finns med eller utan armstöd.

Fåtöljen sits och rygg kan kläs i tyg, läder, konstläder eller efter önskemål. Rekommendation är att välja ett tyg som är tvätt- och stretchbart. Tyger generellt bör vara något tójbara. Randiga och rutiga mönster bör undvikas.

Tillval: avtagbar klädsel på sits.

Fåtöljen levereras monterad. Med hjälp av handverktyg är det enkelt att separera ryggskaet från benstativ och vid en eventuell omklädsel skruvas sits och rygg snäpps enkelt bort.

Ange vid beställning: artikelnummer, utförande på trä, tyg, läder samt tass för metallstativ.

Sander Lounge

Wood: oak, ash, standard stains on ash and white glazed on oak or ash.

Base: Legs in solid wood incl. felt feet. 4-star base in metal black powder coating or polished, has swivel and a reversible seat, (not adjustable). The 4-star base is equipped with felt feet for hard surfaces or plastic feet for soft surfaces. Available with or without armrest.

The seat and back may be covered in a fabric of choice or real or synthetic leather, according to customer wishes.

Fabrics should generally be somewhat stretchable. Avoid striped/checkered patterns. A removable seat cover with an interliner of hospital-grade fabric or lining cloth is available as an optional extra, recommendation is to choose a fabric that is washable and stretchable.

The easy chair is supplied assembled. Hand tools are all that is needed to simply detach the back shell from the leg frame. It is a simple matter to separate seat and back, if the chair is to be re-covered.

State when ordering: article number, finish of wood, fabric, leather and feet protection of 4-star base.

Artno Sander Lounge



SAF100
Klädd sits
Upholstered seat



SAF101s = black
SAF101p = matt polished
Klädd sits
Upholstered seat



SAF200
Klädd sits
Upholstered seat



SAF201s = black
SAF201p = matt polished
Klädd sits
Upholstered seat



SAF110
Klädd sits och rygg
Upholstered seat and back



SAF111s = black
SAF111p = matt polished
Klädd sits och rygg
Upholstered seat and back



SAF210
Klädd sits och rygg
Upholstered seat and back



SAF211s = black
SAF211p = matt polished
Klädd sits och rygg
Upholstered seat and back

Artno	Bredd Width mm	Djup Depth mm	Höjd Height mm	Sithöjd Seat height mm	Armstöd Armrest höjd height mm	Sander Lounge SEK			Extra SEK			Tytgång på 140 cm bredd Requirement of fabric width 140 cm	Vikt netto Weight net kilos	Volym Volume net
						.10 ek oak .30 ask ash	.10 ek oak .30 ask ash	.10 ek oak .30 ask ash	Standardbets på ask Standard stain on ash Vitpigment ek ask White glazed oak ash	Avtagbar klädsel på sits, urinröv Removable cover on seat, an interliner of hospital-grade	Avtagbar klädsel på sits, domestik Removable cover on seat, lining cloth			
utan armstöd excl. armrest						1 styck pc	2-10 styck pcs	11- styck pcs	per styck each	per styck each	per styck each			
SAF100	550	640	780	430		10660	10440	10300	+1270	+1120	+990	70 cm	9	0,34
SAF101s	550	640	800	425		11930	11700	11580	+1030	+1120	+990	70 cm	14	0,33
SAF101p	550	640	800	425		12150	11910	11780	+1030	+1120	+990	70 cm	14	0,33
SAF110	550	640	780	430		12920	12550	12310	+1030	+1120	+990	70 cm	9	0,34
SAF111s	550	640	800	425		14180	13820	13580	+980	+1120	+990	70 cm	14	0,33
SAF111p	550	640	800	425		14380	14030	13790	+980	+1120	+990	70 cm	14	0,33
med armstöd incl. armrest														
SAF200	655	640	780	430	575	11700	11470	11340	+1320	+1120	+990	70 cm	10	0,34
SAF201s	655	640	800	425	570	12980	12750	12620	+1090	+1120	+990	70 cm	15	0,33
SAF201p	655	640	800	425	570	13190	12960	12810	+1090	+1120	+990	70 cm	15	0,33
SAF210	655	640	780	430	575	13960	13590	13350	+1090	+1120	+990	70 cm	10	0,34
SAF211s	655	640	800	425	570	15230	14870	14630	+1030	+1120	+990	70 cm	15	0,33
SAF211p	655	640	800	425	570	15430	15080	14840	+1030	+1120	+990	70 cm	15	0,33

Extra Tyg Läder, Fabric Leather

Klädd sits Upholstered seat

Artno SAF100, SAF101, SAF200, SAF201

SEK/styck pc	1 styck pc	2-10 styck pcs	11- styck pcs
Prisgrupp Pricegroup 1	+1490	+750	+540
Prisgrupp Pricegroup 2	+1750	+880	+680
Prisgrupp Pricegroup 3	+2020	+1010	+820
Prisgrupp Pricegroup 4	+2280	+1140	+970
Standard läder leather	+1040	+1040	+1040

Extra Tyg Läder, Fabric Leather

Klädd sits och rygg Upholstered seat and back

Artno SAF110, SAF111, SAF210, SAF211

SEK/styck pc	1 styck pc	2-10 styck pcs	11- styck pcs
Prisgrupp Pricegroup 1	+1490	+1190	+940
Prisgrupp Pricegroup 2	+1750	+1450	+1200
Prisgrupp Pricegroup 3	+2020	+1710	+1460
Prisgrupp Pricegroup 4	+2280	+1970	+1720
Standard läder leather	+2040	+2040	+2040

SANDER CHAIR Roger Persson 2025

Sander Chair.

Träslag: ek, ask, standardbetsar på ask och vitpigmenterad ek eller ask.
Ben i massiv trä inkl. filltass. Stolen finns med eller utan armstöd som är i massivt trä. Sits och rygg kan kläs i tyg, läder, konstläder eller efter önskemål. Rekommendation är att välja ett tyg som är tvätt- och stretchbart. Tyger generellt bör vara något tåjbara. Randiga och rutiga mönster bör undvikas. Tillval: avtagbar klädsel på sits. Stolen levereras monterad. Med hjälp av handverktyg är det enkelt att separera ryggskalet från benstativ och vid en eventuell omklädsel skruvas sits och rygg snäpps enkelt bort.

Ange vid beställning: artikelnummer, utförande på trä, tyg och läder.

Sander Chair.

Wood: oak, ash, standard stains on ash and white glazed on oak or ash.
Base: Legs in solid wood incl. felt feet. Sander Chair available with or without armrest. Armrest in solid wood The seat and back may be covered in a fabric of choice or real or synthetic leather, according to customer wishes. Fabrics should generally be somewhat stretchable. Avoid striped/checkered patterns. A removable seat cover with an interliner of hospital-grade fabric or lining cloth is available as an optional extra, recommendation is to choose a fabric that is washable and stretchable.

The chair is supplied assembled. Hand tools are all that is needed to simply detach the back shell from the leg frame. It is a simple matter to separate seat and back, if the chair is to be re-covered.

State when ordering: article number, finish of wood, fabric and leather.

Artno Sander Chair



SAS500
Klädd sits
Upholstered seat



SAS510
Klädd sits och rygg
Upholstered seat and back



SAS600
Klädd sits
Upholstered seat



SAS610
Klädd sits och rygg
Upholstered seat and back

Artno	Bredd Width mm	Djup Depth mm	Höjd Height mm	Sithöjd Seat height mm	Armstöd Armrest höjd height mm	Sander Chair SEK			Extra SEK					
						.10 ek oak .30 ask ash	.10 ek oak .30 ask ash	.10 ek oak .30 ask ash	Standardbets på ask Standard stain on ash Vitpigment ek ask White glazed oak ash	Avtagbar klädsel på sits, urinväv Removable cover on seat, an interliner of hospital-grade	Avtagbar klädsel på sits, domestik Removable cover on seat, lining cloth	Tygåtgång på 140 cm bredd Requirement of fabric width 140 cm	Vikt netto Weight net kilos	Volym Volume net
utan armstöd excl. armrest						1 styck pc	2-10 styck pcs	11- styck pcs	per styck each	per styck each	per styck each			
SAS500	480	565	825	460		8150	7940	7820	+980	+1120	+990	70 cm	8	0,26
SAS510	480	565	825	460		10260	9830	9600	+980	+1120	+990	70 cm	8	0,26
med armstöd incl. armrest														
SAS600	555	565	825	460	640	9200	8990	8870	+980	+1120	+990	70 cm	9	0,3
SAS610	555	565	825	460	640	11320	10880	10650	+980	+1120	+990	70 cm	9	0,3

Extra Tyg Läder, Fabric Leather

Klädd sits Upholstered seat

Artno SAS500, SAS600

SEK/styck pc	1 styck pc	2-10 styck pcs	11- styck pcs
Prisgrupp Pricegroup 1	+1490	+750	+540
Prisgrupp Pricegroup 2	+1750	+880	+680
Prisgrupp Pricegroup 3	+2020	+1010	+820
Prisgrupp Pricegroup 4	+2280	+1140	+970
Standard läder leather	+1040	+1040	+1040

Extra Tyg Läder, Fabric Leather

Klädd sits och rygg Upholstered seat and back

Artno SAS510, SAS610

SEK/styck pc	1 styck pc	2-10 styck pcs	11- styck pcs
Prisgrupp Pricegroup 1	+1490	+1190	+940
Prisgrupp Pricegroup 2	+1750	+1450	+1200
Prisgrupp Pricegroup 3	+2020	+1710	+1460
Prisgrupp Pricegroup 4	+2280	+1970	+1720
Standard läder leather	+2040	+2040	+2040

SANDER MEETING Roger Persson 2025 Möbelfakta

Sander Meeting.

Träslag: ek, ask, standardbetsar på ask och vitpigmenterad ek eller ask.

Fem hjul ej låsbara, i färg svart pulverlack eller polerad. Snurrbar, höj- och sänkbar sits. Stolen finns med eller utan armstöd som är i massivt trä. Sits och rygg kan kläs i tyg, läder, konstläder eller efter önskemål. Rekommendation är att välja ett tyg som är tvätt- och stretchbart. Tyger generellt bör vara något töljbara. Randiga och rutiga mönster bör undvikas. Tillval: avtagbar klädsel på sits.

Sander Meeting levereras monterad. Med hjälp av handverktyg är det enkelt att separera ryggskalet från benstativ och vid en eventuell omklädsel skruvas sits och rygg snäpps enkelt bort.

Ange vid beställning: artikelnummer, utförande på trä, tyg och läder.

Sander Meeting.

Wood: oak, ash, standard stains on ash and white glazed on oak or ash.

Five wheels stand (not lockable). in black powder coating or polished. All chairs are swivel and adjustable height. Sander Meeting available with or without armrest. Armrest in solid wood. The seat and back may be covered in a fabric of choice or real or synthetic leather, according to customer wishes. Fabrics should generally be somewhat stretchable. Avoid striped/checkered patterns. A removable seat cover with an interliner of hospital-grade fabric or lining cloth is available as an optional extra, recommendation is to choose a fabric that is washable and stretchable. The chair is supplied assembled. Hand tools are all that is needed to simply detach the back shell from the leg frame.

It is a simple matter to separate seat and back, if the chair is to be re-covered.

State when ordering: article number, finish of wood, fabric and leather.

Artno Sander Meeting



SAM508s = black
SAM508p = matt polished
Klädd sits
Upholstered seat



SAM518s = black
SAM518p = matt polished
Klädd sits och rygg
Upholstered seat and back



SAM608s = black
SAM608p = matt polished
Klädd sits
Upholstered seat



SAM618s = black
SAM618p = matt polished
Klädd sits och rygg
Upholstered seat and back

Artno	Bredd Width mm	Bredd inkl. hjul Width incl. castors mm	Djup Depth mm	Höjd Height mm	Sithöjd Seat height mm	Armstöd Armrest höjd height mm	Sander Meeting SEK			Extra SEK				
							.10 ek oak .30 ask ash	.10 ek oak .30 ask ash	.10 ek oak .30 ask ash	Standardbets på ask Standard stain on ash Vitpigment ek ask White glazed oak ash	Avtagbar klädsel på sits, domestik Removable cover on seat, lining cloth	Tygåtgång på 140 cm bredd Requirement of fabric width 140 cm	Vikt netto Weight net kilos	Volym Volume net
utan armstöd excl. armrest							1 styck pc	2-10 styck pcs	11- styck pcs	per styck each	per styck each			
SAM508s	480	640	565	800/935	430/565		8560	8340	8230	+700	+990	70 cm	13	0,44
SAM508p	480	640	565	800/935	430/565		9030	8810	8690	+700	+990	70 cm	13	0,44
SAM518s	480	640	565	800/935	430/565		10670	10230	10000	+700	+990	70 cm	13	0,44
SAM518p	480	640	565	800/935	430/565		11140	10700	10470	+700	+990	70 cm	13	0,44
med armstöd incl. armrest														
SAM608s	555	640	565	800/935	430/565	620/755	9610	9390	9280	+700	+990	70 cm	14	0,5
SAM608p	555	640	565	800/935	430/565	620/755	10080	9860	9740	+700	+990	70 cm	14	0,5
SAM618s	555	640	565	800/935	430/565	620/755	11720	11280	11060	+700	+990	70 cm	14	0,5
SAM618p	555	640	565	800/935	430/565	620/755	12190	11750	11520	+700	+990	70 cm	14	0,5

Extra Tyg Läder, Fabric Leather

Klädd sits Upholstered seat

Artno SAM508, SAM608

SEK/styck pc	1 styck pc	2-10 styck pcs	11- styck pcs
Prisgrupp Pricegroup 1	+1490	+750	+540
Prisgrupp Pricegroup 2	+1750	+880	+680
Prisgrupp Pricegroup 3	+2020	+1010	+820
Prisgrupp Pricegroup 4	+2280	+1140	+970
Standard läder leather	+1040	+1040	+1040

Extra Tyg Läder, Fabric Leather

Klädd sits och rygg Upholstered seat and back

Artno SAM518, SAM618

SEK/styck pc	1 styck pc	2-10 styck pcs	11- styck pcs
Prisgrupp Pricegroup 1	+1490	+1190	+940
Prisgrupp Pricegroup 2	+1750	+1450	+1200
Prisgrupp Pricegroup 3	+2020	+1710	+1460
Prisgrupp Pricegroup 4	+2280	+1970	+1720
Standard läder leather	+2040	+2040	+2040

SANDER BAR Roger Persson 2025

Möbelfakta

Sander Bar.

Träslag: ek, ask, standardbetsar på ask och vitpigmenterad ek eller ask.
 Underrede ben i massiv trä med filtass. Fotstöd är försedd med infräst skydd i rostfritt stål.
 Sits och rygg kan kläs i tyg, läder, konstläder eller efter önskemål. Rekommendation är att välja ett tyg som är tvätt- och stretchbart. Tyger generellt bör vara något tåjbara. Randiga och rutiga mönster bör undvikas.
 Sander Bar levereras monterad. Med hjälp av handverktyg är det enkelt att separera ryggskalet från benstativ och vid en eventuell omklädning skruvas sitsen bort och ryggen snäpps av.
 Ange vid beställning: artikelnummer, utförande på trä, tyg och läder.

Sander Bar.

Wood: oak, ash, standard stains on ash and white glazed on oak or ash.
 Legs in solid wood incl. felt feet. The footrest has a stainless steel footrest protector. The seat and back may be covered in a fabric of choice or real or synthetic leather, according to customer wishes. Fabrics should generally be somewhat stretchable. Avoid striped/checkered patterns. The easy chair is supplied assembled. Hand tools are all that is needed to simply detach the back shell from the leg frame. It is a simple matter to separate seat and back, if the chair is to be re-covered.
 State when ordering: article number, finish of wood, fabric or leather.

Artno Sander Bar



SAP65T SH655 Klädd sits Upholstered seat
 SAP65K SH655 Klädd sits och rygg Upholstered seat and back
 SAP75T SH755 Klädd sits Upholstered seat
 SAP75K SH755 Klädd sits och rygg Upholstered seat and back

Artno	Bredd Width mm	Djup Depth mm	Höjd Height mm	Sithöjd Seat height mm	Sander Bar SEK			Extra SEK	Tytgång på 140 cm bredd Requirement of fabric width 140 cm	Vikt netto Weight net kilos	Volym Volume net
					.10 ek oak .30 ask ash	.10 ek oak .30 ask ash	.10 ek oak .30 ask ash	Standardbets på ask Standard stain on ash Vitpigment ek ask White glazed oak ash			
					1 styck pc	2-10 styck pcs	11- styck pcs	per styck each			
SAP65T	490	520	925	655	9760	9540	9420	+1220	70 cm	8	0,28
SAP65K	490	520	925	655	11680	11240	11010	+1220	70 cm	8	0,28
SAP75T	490	520	1025	755	9840	9620	9510	+1220	70 cm	8	0,3
SAP75K	490	520	1025	755	11760	11280	11100	+1220	70 cm	8	0,3

SANDER CAFÉ Roger Persson 2025

Möbelfakta

Sander Café.

Träslag: ek, ask, standardbetsar på ask och vitpigmenterad ek eller ask.
 Underrede ben i massiv trä med filtass. Sits och rygg kan kläs i tyg, läder, konstläder eller efter önskemål. Rekommendation är att välja ett tyg som är tvätt- och stretchbart. Tyger generellt bör vara något tåjbara. Randiga och rutiga mönster bör undvikas. Sander Bar levereras monterad. Med hjälp av handverktyg är det enkelt att separera ryggskalet från benstativ och vid en eventuell omklädning skruvas sitsen bort och ryggen snäpps av.
 Ange vid beställning: artikelnummer, utförande på trä, tyg och läder.

Sander Café.

Wood: oak, ash, standard stains on ash and white glazed on oak or ash.
 Legs in solid wood incl. felt feet. The seat and back may be covered in a fabric of choice or real or synthetic leather, according to customer wishes. Fabrics should generally be somewhat stretchable. Avoid striped/checkered patterns. The easy chair is supplied assembled. Hand tools are all that is needed to simply detach the back shell from the leg frame. It is a simple matter to separate seat and back, if the chair is to be re-covered.
 State when ordering: article number, finish of wood, fabric or leather.

Artno Sander Café



SAK46T Klädd sits Upholstered seat
 SAK46K Klädd sits och rygg Upholstered seat and back

Artno	Bredd Width mm	Djup Depth mm	Höjd Height mm	Sithöjd Seat height mm	Sander Café SEK			Extra SEK	Tytgång på 140 cm bredd Requirement of fabric width 140 cm	Vikt netto Weight net kilos	Volym Volume net
					.10 ek oak .30 ask ash	.10 ek oak .30 ask ash	.10 ek oak .30 ask ash	Standardbets på ask Standard stain on ash Vitpigment ek ask White glazed oak ash			
					1 styck pc	2-10 styck pcs	11- styck pcs	per styck each			
SAK46T	490	520	708	460	7940	7720	7600	+950	70 cm	7	0,23
SAK46K	490	520	708	460	9860	9420	9190	+950	70 cm	7	0,23

Extra Tyg Läder, Fabric Leather

Klädd sits Upholstered seat
 Artno SAP65T, SAP75T, SAK46T

SEK/styck pc	1 styck pc	2-10 styck pcs	11- styck pcs
Prisgrupp Pricegroup 1	+1490	+750	+540
Prisgrupp Pricegroup 2	+1750	+880	+680
Prisgrupp Pricegroup 3	+2020	+1010	+820
Prisgrupp Pricegroup 4	+2280	+1140	+970
Standard läder leather	+1040	+1040	+1040

Extra Tyg Läder, Fabric Leather

Klädd sits och rygg Upholstered seat and back
 Artno SAP65K, SAP75K, SAK46K

SEK/styck pc	1 styck pc	2-10 styck pcs	11- styck pcs
Prisgrupp Pricegroup 1	+1490	+1190	+940
Prisgrupp Pricegroup 2	+1750	+1450	+1200
Prisgrupp Pricegroup 3	+2020	+1710	+1460
Prisgrupp Pricegroup 4	+2280	+1970	+1720
Standard läder leather	+2040	+2040	+2040

Soff-/Bänk system.

Meander består av rak soffa och bänk i tre olika längder, samt kurvade delar i 45 och 90 graders vinkel. Soffans rygg är böjd antingen som en inner- eller ytterdel. Alla gavlur är förberedda för förankring i golv. Soffa och bänk kan kopplas samman, förses med armstöd. Träslagen är ek, ask, standardbetsler på ask och vitpigmenterad ek eller ask. Meander levereras monterad. Om skada uppstår på sits eller rygg går det enkelt att skruva loss med handverktyg och byta ut eller slipa om. Tillbehör: kopplingsbeslag, eluttag och pop-up bord.

Sofa/Bench system.

Meander comprises a straight sofa and bench in three different lengths, complemented by curved modules with 45° and 90° angles. The sofa's backrest follows the curved inner or outer lines of the sofa. All end sections are prepared so that they can be anchored to the floor. Sofa and bench sections can be linked and fitted with armrests. Choose from oak, ash, standard stains on ash, or white glaze on oak or ash. Meander is supplied assembled. Any damage sustained to seat or backrest can simply be repaired by unscrewing the element in question with a hand tool and replacing it or sanding down the affected area. Accessories: Link fittings, electrical outlet and pop-up table.

Artno SOFFA RAK SOFA STRAIGHT

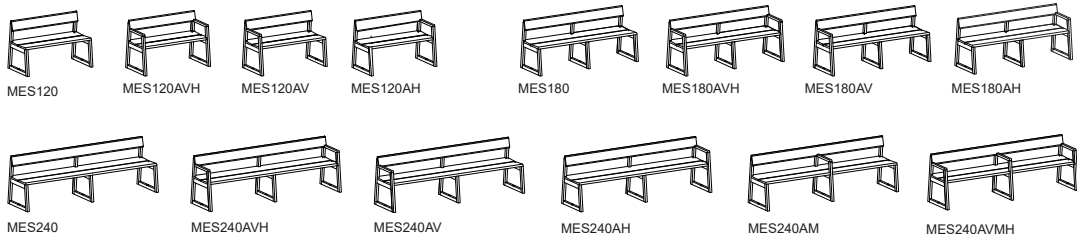

Artno BÄNK RAK BENCH STRAIGHT

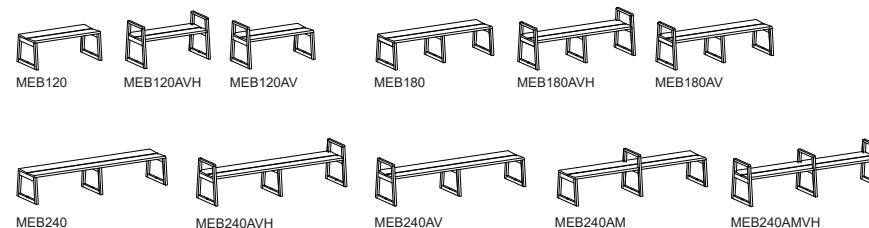

SOFFA SOFA INNER 45°



SOFFA YTTRE SOFA OUTER 45°

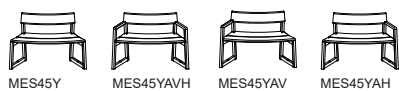

SOFFA SOFA INNER 90°

endast för koppling eller fästas i golv
only for connecting or secured into floor



SOFFA YTTRE SOFA OUTER 90°

endast för koppling eller fästas i golv
only for connecting or secured into floor



BÄNK BENCH 45°

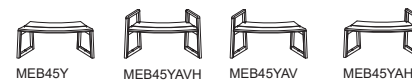

BÄNK BENCH 90°

endast för koppling eller fästas i golv
only for connecting or secured into floor

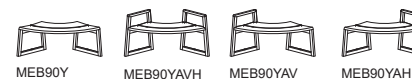

FÖRSLAG SUGGESTIONS

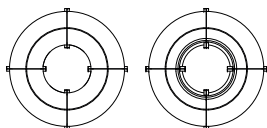

4 x MEB90Y
diam 1920/650

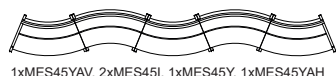

1xMES45YAV, 2xMES45I, 1xMES45Y, 1xMES45YAH
L5175 W740

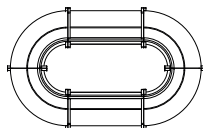

2xMES120AVH, 4xMES90Y
L3120 W1920 innermått inner L1850 W650

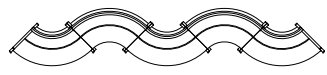

1xMES90YAV, 2xMES90I, 1xMES90Y, 1xMES90YAH
L5005 W920

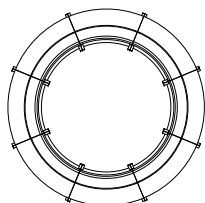

8 x MES45Y
diam 3220/1940

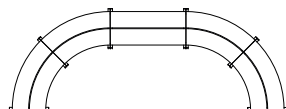

1xMEB120, 4xMEB45Y
L3940 W1830

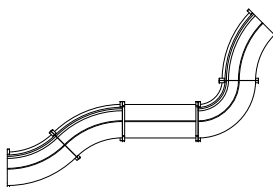

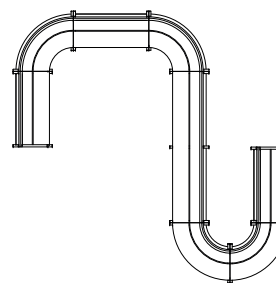

1xMES45Y, 2xMES45I, 1xMEB120AVH, 1xMES90Y
L4280 W2850



1xMES120AV 2xMES90I, 1xMES120,
1xMES240, 2xMES90Y, 1xMES120AH
L4420 W4330

Artno	Längd Length mm	Djup Depth mm	Höjd Height mm	Sithöjd Seat height mm	Meander SEK		Extra SEK		
					.10 ek oak .30 ask ash	Standardbets på ask Standard stain on ash	Vikt netto Weight net kilos	Vikt brutto Weight gross kilos	Volym Volume net
SOFFA RAK SOFA STRAIGHT									
MES120	1200	625	800	470	14120	+2110	20	50	0,42
MES120AVH	1200	625	800	470	15030	+2260	22	52	0,42
MES120AV	1200	625	800	470	14570	+2170	21	51	0,42
MES120AH	1200	625	800	470	14570	+2170	21	51	0,42
MES180	1800	625	800	470	20980	+3160	32	70	0,67
MES180AVH	1800	625	800	470	21860	+3270	34	72	0,67
MES180AV	1800	625	800	470	21410	+3220	33	71	0,67
MES180AH	1800	625	800	470	21410	+3220	33	71	0,67
MES240	2400	625	800	470	24380	+3660	38	80	0,82
MES240AVH	2400	625	800	470	25270	+3810	40	82	0,82
MES240AV	2400	625	800	470	24840	+3830	39	81	0,82
MES240AH	2400	625	800	470	24840	+3830	39	81	0,82
MES240AM	2400	625	800	470	24840	+3830	39	81	0,82
MES240AVMH	2400	625	800	470	25740	+3850	41	82	0,82
SOFFA SOFA 45 °									
MES45I	1225/750	625	800	470	19730	+2970	19	50	0,42
MES45IAV	1220/750	625	800	470	20210	+3030	20	51	0,42
MES45IAH	1220/750	625	800	470	20210	+3030	20	51	0,42
MES45Y	1225/750	625	800	470	19000	+2850	19	50	0,42
MES45YAVH	1225/750	625	800	470	19920	+3000	22	52	0,42
MES45YAV	1225/750	625	800	470	19460	+2920	20	51	0,42
MES45YAH	1225/750	625	800	470	19460	+2920	20	51	0,42
SOFFA SOFA 90 °									
MES90I	1350/475	625	800	470	21080	+3170	20	51	0,53
MES90IAV	1350/475	625	800	470	21540	+3230	21	52	0,53
MES90IAH	1350/475	625	800	470	21540	+3230	21	52	0,53
MES90Y	1350/475	625	800	470	19500	+2920	19	50	0,53
MES90YAVH	1350/475	625	800	470	20400	+3060	21	52	0,53
MES90YAV	1350/475	625	800	470	19960	+3000	20	51	0,53
MES90YAH	1350/475	625	800	470	19960	+3000	20	51	0,53

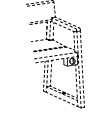
Artno	Längd Length mm	Djup Depth mm	Höjd Height mm	Sithöjd Seat height mm	Meander SEK		Extra SEK		
					.10 ek oak .30 ask ash	Standardbets på ask Standard stain on ash	Vikt netto Weight net kilos	Vikt brutto Weight gross kilos	Volym Volume net
BÄNK RAK BENCH STRAIGHT									
MEB120	1200	625		470	11320	+1700	16		0,42
MEB120AVH	1200	625	670	470	12440	+1870	18		0,42
MEB120AV	1200	625	670	470	11880	+1790	17		0,42
MEB180	1800	625		470	16930	+2540	25		0,67
MEB180AVH	1800	625	670	470	18040	+2700	27		0,67
MEB180AV	1800	625	670	470	17470	+2630	26		0,67
MEB240	2400	625		470	19520	+2940	29		0,82
MEB204AVH	2400	625	670	470	20650	+3080	31		0,82
MEB240AV	2400	625	670	470	20090	+3020	30		0,82
MEB240AM	2400	625	670	470	20090	+3020	30		0,82
MEB240AVMH	2400	625	670	470	21240	+3200	32		0,82
BÄNK BENCH 45 °									
MEB45Y	1225/750	625		470	15110	+2270	18		0,42
MEB45YAVH	1225/750	625	670	470	16240	+2430	18		0,42
MEB45YAV	1225/750	625	670	470	15670	+2360	19		0,42
MEB45YAH	1225/750	625	670	470	15670	+2360	19		0,42
BÄNK BENCH 90 °									
MEB90Y	1350/475	625		470	15850	+2380	18		0,53
MEB90YAVH	1350/475	625	670	470	16980	+2550	20		0,53
MEB90YAV	1350/475	625	670	470	16410	+2450	19		0,53
MEB90YAH	1350/475	625	670	470	16410	+2450	19		0,53

Tillbehör Accessories Sofa Sofa Bänk Bench	Artno	SEK	
	MEKB	Kopplingsbeslag i metall placerad under sits. Link fittings metal placed under the seat.	230
	MEEL	1 eluttag inkl. 2 meter kabel. Placeras nära ben i framkant under sits. Gäller för SE, NO, FIN, DE, NL. 1 electrical outlets incl. 2 meters cable. Placed close to legs in front under the seat. For SE, NO, FIN, DE, NL.	1990
	MEPUB	Pop-up bord diam 260mm. Massiv trä, metall svart finstruktur. Pop-up table diam 260mm. Solid wood, metal black powder coating.	3010 std.bets/stain +300

ONDULÉ Anton Björsing 2022

Sofforna 3-sits och 2-sits finns med både hög och låg rygg. Soffan 1,5-sits finns endast med hög rygg medan fåtöljen finns endast med låg rygg. Gemensamt för alla modeller är att de finns i två sitthöjder; 430 och 480 mm. Rygg och gavel kommer i beige, antracit eller ljusgrå filt, alternativt kan kläs med likadant tyg som sitt- och ryggdyna (läder går dock ej att klä ryggen i). Samtliga dynor består av kallskum och kan kläs i tyg eller läder. Tjocka tyger bör undvikas. Fråga gärna innan eget tygval.

Benen är försedda med filttassar. Träslagen är massiv ek, ask, standardbetser på ask och vitpigmenterad ek eller ask. Som tillval finns sidokuddar. Pop-up bord, till 3- och 2-sits, i massivträ med lika utförande som soffa. Man kan eftermontera pop-up bord. Eluttag kan monteras i sargen framtill. Ondulé levereras monterad. Med hjälp av handverktyg är det enkelt att separera överliggaren av stommen, benen och sarg, rundstavar, rygg och klädselmaterial.
Ange vid beställning: Artikelnummer, färg på gavel/rygg, klädsel på sittplymår, utförande samt ev. tillbehör.

The 2-seat and 3-seat sofas come in both high-back and low-back versions. The 1.5-seat sofa is available with a high back only, while the armchair has a low back. All models offer a choice of two seating heights: 430 mm and 480 mm. The textile backs are in beige, light-grey or anthracite felt, although they may also be ordered in the same fabric as the seat and back cushions. (Please note, however, that it is not possible to choose back covers in leather.) All cushions are of cold-cured foam and can be covered in textile or leather. Thick fabrics are not recommended. Please ask before deciding on your own choice of cover.

Legs are available in a choice of solid oak or ash, standard stains on ash, or white glaze on oak or ash, all with felt floor protectors. Optional extras are side cushions and a pop-up table, for 3- and 2-seat, in solid wood to match your chosen finish on the sofa. Pop-up tables can be added at a later stage. Electrical outlets can be fitted to the front of the rail. Ondulé is supplied assembled. The appropriate hand tools are all that is required to simply disassemble the top rail of the frame, the legs, the apron rail, rods, back and covers. Note when ordering: Article number, color of gable/back, fabric, finish and any accessories.

Artno

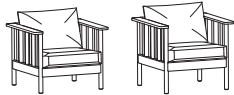

ON1004

ON1007

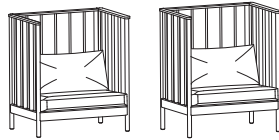

ON1554

ON1557

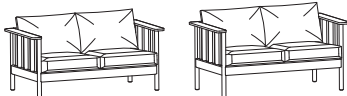

ON2004

ON2007

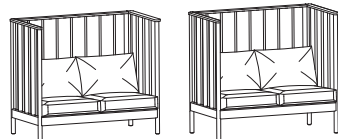

ON2054

ON2057



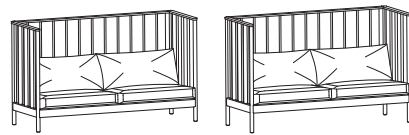

ON3004

ON3007

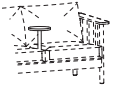

ON3054

ON3057

Tillbehör Accessories	Artno	Mått Dimension mm		SEK
	se sid 99 see page 99		Gavel och rygg klädd i tyg (ej i läder). Side and back upholstered in fabric (not in leather).	sid page 99
	ONSK	L620 H280	Sidokudde. 2st. Side cushions. 2pcs.	sid page 99
	ONPUB .10 ek oak .30 ask ash stain on ash or white glazed on oak ash	ø260	Pop-up bord. Massiv trä, klarlack. Placerad mellan sittdynor. Endast till ON2004, 2007, 2054, 2057, 3004, 3007, 3054, 3057 Pop-up table. Solid wood, clear lacquer. Placed between seats. Only for models ON2004, 2007, 2054, 2057, 3004, 3007, 3054, 3057	2370 +360 stain or glazed
	TKB11	ø57	Powerdot Mini. 1 eluttag, svart, 1,5m kabel. Monteras i sargen framtill nära ben. Gäller för SE,NO,FIN,DE,NL. Powerdot Mini. 1 electrical black, 1,5m cable. Electrical outlets can be fitted to the front of the rail close to leg. For SE,NO,FIN,DE,NL.	840
	TKB19	ø57	Powerdot Mini. USB C laddare inkl. 2 portar, svart, 1,25m kabel. Gäller för SE,NO,FIN,DE,NL. Powerdot Mini. USB C charging incl. 2 ports, black, 1,25m cable. For SE,NO,FIN,DE,NL.	1380

Artno	Rygg, gavel filt Back, side felt -1 light gray -2 anthracite -3 beige	Längd Length mm	Djup Depth mm	Höjd Height mm	Sithöjd Seat height mm	Ondulé SEK	Extra SEK					Tygätgång på 140 cm bredd till sitt- och ryggplymā Requirement of fabric width 140 cm for seat and back cushion	Vikt netto Weight net kilos	Volym Volume net	
						.10 ek oak .30 ask ash	Standardbets på ask Standard stain on ash Vitpigment ek ask White glazed oak ash	Tyg Fabric Prisgrupp Pricegroup 1	Tyg Fabric Prisgrupp Pricegroup 2	Tyg Fabric Prisgrupp Pricegroup 3	Tyg Fabric Prisgrupp Pricegroup 4				Standard läder Leather
ON1004	-1 light gray -2 anthracite -3 beige	865	810	790	420	25240	+2520	+2620	+3220	+3820	+4420	+5670	160 cm	28	1,08
ON1007	-1 light gray -2 anthracite -3 beige	865	810	860	490	25240	+2520	+2620	+3220	+3820	+4420	+5670	160 cm	30	1,13
ON1554	-1 light gray -2 anthracite -3 beige	1080	810	1200	420	34350	+3010	+3740	+4680	+5620	+6550	+7440	250 cm	42	1,48
ON1557	-1 light gray -2 anthracite -3 beige	1080	810	1270	490	34350	+3010	+3740	+4680	+5620	+6550	+7440	250 cm	44	1,53
ON2004	-1 light gray -2 anthracite -3 beige	1530	810	790	420	38100	+3820	+4620	+5820	+7020	+8220	+11360	320 cm	44	1,44
ON2007	-1 light gray -2 anthracite -3 beige	1530	810	860	490	38100	+3820	+4620	+5820	+7020	+8220	+11360	320 cm	46	1,51
ON2054	-1 light gray -2 anthracite -3 beige	1415	810	1200	420	44250	+4430	+4620	+5820	+7020	+8220	+11360	320 cm	54	2,1
ON2057	-1 light gray -2 anthracite -3 beige	1415	810	1270	490	44250	+4430	+4620	+5820	+7020	+8220	+11360	320 cm	58	2,16
ON3004	-1 light gray -2 anthracite -3 beige	2190	810	790	420	45950	+4600	+6870	+8740	+10620	+12490	+14880	500 cm	65	2,07
ON3007	-1 light gray -2 anthracite -3 beige	2190	810	860	490	45950	+4600	+6870	+8740	+10620	+12490	+14880	500 cm	70	2,17
ON3054	-1 light gray -2 anthracite -3 beige	2080	810	1200	420	53480	+5350	+6870	+8740	+10620	+12490	+14880	500 cm	75	2,8
ON3057	-1 light gray -2 anthracite -3 beige	2080	810	1270	490	53480	+5350	+6870	+8740	+10620	+12490	+14880	500 cm	80	2,9

Artno	Ondulé SEK	Tyg Fabric Prisgrupp Pricegroup 1	Tyg Fabric Prisgrupp Pricegroup 2	Tyg Fabric Prisgrupp Pricegroup 3	Tyg Fabric Prisgrupp Pricegroup 4	Standard läder Leather	Tygätgång 140cm bredd till gavel och rygg Requirement of fabric width 140 cm for gavel and back	Tygätgång 140cm bredd till sidokudde Requirement of fabric width 140 cm for side pillow
Tillbehör Accessories								
Klädsel gavel och bakrygg till Upholstery side and back for								
ON1004-9, ON1007-9	1240	+3120	+3870	+4620	+5370	--	200 cm	
ON1554-9, ON1557-9	1350	+8620	+11020	+13420	+15820	--	640 cm	
ON2004-9, ON2007-9	1580	+3120	+3870	+4620	+5370	--	200 cm	
ON2054-9, ON2057-9	1580	+9490	+12150	+14820	+17480	--	710 cm	
ON3004-9, ON3007-9	1880	+3490	+4350	+5220	+6080	--	230 cm	
ON3054-9, ON3057-9	1880	+11240	+14430	+17620	+20800	--	850 cm	
ONSK 2pcs Sidokudde Side cushions	3840	+1490	+1750	+2020	+2280	+2390		70 cm

ONDULÉ CLUB Anton Björns 2024 Möbelfakta

Fåtölj och Soffa 2-sits.

Ondulé Club finns i sitthöjderna 430 och 470mm. Utförande är massiv ek, ask, standardbetser samt vitpigmenterad ek och ask. Sitt- och ryggdyna består av kallskum och kan kläs i tyg eller läder. Tjocka tyger bör undvikas. Fråga gärna innan eget tygval.

Utsidan i pressad återvunnen filt i färg beige, ljusgrå och antracit alternativt att man klär utsidan i samma tyg som insidan (obs! utsidan går ej att få i tjocka tyger och läder).

Benen är försedd med filtass. Ondulé Club levereras monterad. Alla delar är lätta att demontera och går att byta ut vid eventuell skada eller för omklädsel. Vid beställning ange artikelnummer, utförande samt tyg/läder.

Easy chair and Sofa 2-seat.

Ondulé Club is available in seat heights 430 and 470mm. Versions are in solid oak, ash, standard stains and white-glazed oak and ash.

The seat and back cushion are of cold-cured foam and can be covered in textile or leather. Thick fabrics are not recommended.

Please ask before choosing your own textile.

The outside in pressed recycled felt in the colors beige, light gray and anthracite, alternatively to dress the outside in the same textile as the inside (note: the outside cannot be obtained in thick fabrics and leather).

The legs are equipped with felt paws. Ondulé Club is delivered assembled. All parts are easy to disassemble and can be replaced in case of damage or for change of textile. When ordering, state the article number, design and fabric/leather.

Artno

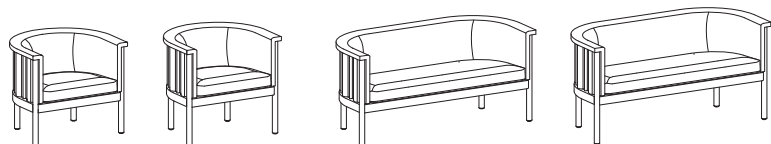

ONC1504

ONC1507

ONC2504

ONC2507

Artno	Rygg, gavel filt Back, side felt -1 light gray -2 anthracite -3 beige	Längd Length mm	Djup Depth mm	Höjd Height mm	Sitt höjd Seat height mm	Ondulé Club SEK		Extra SEK				Standard läder Leather	Tygätgång på 140 cm bredd till sitt- och ryggplymä Requirement of fabric width 140 cm for seat and back cushion	Vikt netto Weight net kilos	Volym Volume net
						.10 ek oak .30 ask ash	Standardbets på ask Standard stain on ash Vitpigment ek ask White glazed oak ash	Tyg Fabric Prisgrupp Pricegroup 1	Tyg Fabric Prisgrupp Pricegroup 2	Tyg Fabric Prisgrupp Pricegroup 3	Tyg Fabric Prisgrupp Pricegroup 4				
ONC1504	-1 light gray -2 anthracite -3 beige	780	660	680	430	22640	+1130	+2740	+3380	+4020	+4650	+6360	170cm	18	0,4
ONC1507	-1 light gray -2 anthracite -3 beige	780	660	720	470	23070	+1150	+2740	+3380	+4020	+4650	+6360	170cm	20	0,42
ONC2504	-1 light gray -2 anthracite -3 beige	1450	660	680	430	29480	+1480	+3620	+4520	+5420	+6320	+8430	240cm	32	0,75
ONC2507	-1 light gray -2 anthracite -3 beige	1450	660	720	470	29920	+1510	+3620	+4520	+5420	+6320	+8430	240cm	34	0,77

Artno	Ondulé Club SEK	Tyg Fabric Prisgrupp Pricegroup 1	Tyg Fabric Prisgrupp Pricegroup 2	Tyg Fabric Prisgrupp Pricegroup 3	Tyg Fabric Prisgrupp Pricegroup 4	Standard läder Leather	Tygätgång 140cm bredd till gavel och rygg Requirement of fabric width 140 cm for gavel and back
Tillbehör Accessories							
Klädsel utsida Upholstery outside						--	
ONC1504-9, ONC1507-9	930	+1370	+1590	+1820	+2040	--	60cm
ONC2504-9, ONC2507-9	1270	+2490	+3050	+3620	+4180	--	135cm

SOIGNÉ Anton Björnsing 2026

Soigné är en välskräddad och luftig sittmöbelserie som är en blinkning till det klassiska skandinaviska hantverket med baktycket i sadelgjord. Den kan möbleras som solitära fätöljer och soffor eller som sammankopplade sektionermoduler. När den står fritt i rummet ser man de fina sadelgjordsdetaljerna. Soigné är det franska ordet för elegant, sofistikerad och välklädd.

Soigné finns som fätölj, 2-sits och 3-sitssoffa med eller utan armstöd, inner- och ytterhörn. Alla delar finns i två sitthöjder 430 mm som passar till lounge sittning och 490 mm vilket passar till mat- och konferensbord höjd.

Stommen är tillverkad i massiv trä i ek, ask, standardbetser eller vitpigmenterad ek eller ask. Ytbehandlingen är klarlack. Ryggen är försedd med sadelgjord i naturfärg (ytterhörnsmodulerna har ingen sadelgjord). Benen är försedda med filtass. Stoppningen är kallskum i HR-kvalitet. Dynor och ryggar kläs i tyg eller läder.

Tillbehör är ytterarmstöd, mellanarmstöd, pop-upbord i massiv trä, eluttag och kopplingsbeslag i svart metall. Soffan kommer monterad och är enkel att demontera och byta klädsel. Vid beställning ange artikelnummer, utförande, namn på tyg eller läder.

Soigné is a well-tailored and airy seating furniture series that is a nod to the classic Scandinavian craftsmanship with webbing. It can be furnished as solitary armchairs and sofas or as interconnected sectional modules. When it stands free in the room, you can see the fine webbing details. Soigné is the French word for elegant, sophisticated and well-dressed.

Soigné is available as an armchair, 2-seater and 3-seater sofa with or without armrests, inner and outer corners. All parts are available in two seat heights: 430 mm which is suitable for lounge seating and 490 mm which is suitable for dining and conference table height.

The frame is made of solid wood in oak, ash, standard stains or white-pigmented oak or ash. The surface finish is clear lacquer. The back is equipped with a natural-colored webbing (the outer corner modules have no webbing). The legs are equipped with felt feet. The padding is cold foam in HR quality. Cushions and backs are covered in fabric or leather.

Accessories include outer armrests, middle armrests, pop-up tables in solid wood, electrical outlets and connection fittings in black metal. The sofa comes assembled and is easy to disassemble and change the upholstery. When ordering please state article number, finish and name of fabric or leather.

Artno

Fätölj, 2-sits, 3-sits inkl. armstöd

Easy chair, 2-seat, 3-seat incl. armrests

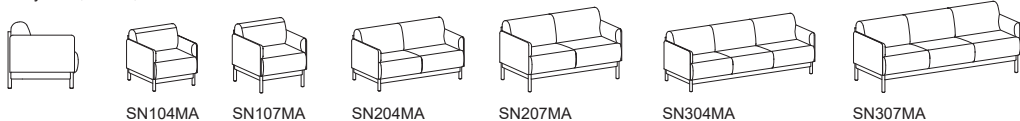

SN104MA

SN107MA

SN204MA

SN207MA

SN304MA

SN307MA

Sektion fätölj/soffa

Section easy chair/sofa

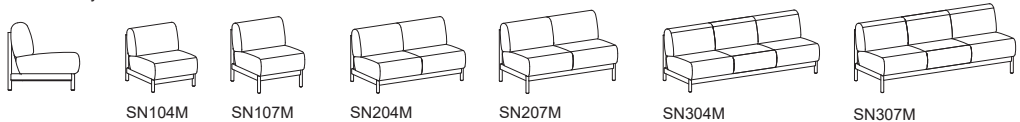

SN104M

SN107M

SN204M

SN207M

SN304M

SN307M

Hörn

Corner

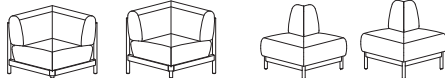

SN104I

SN107I

SN104Y

SN107Y

FÖRSLAG

SUGGESTIONS

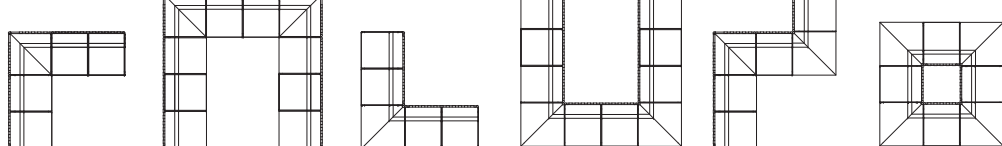

Komb. 1
2xSN204M
1xSN104I
L2190 D2190

Komb. 2
2xSN304M
1xSN204M
2xSN104I
L 2995 D 2885

Komb. 3
2xSN204M
1xSN104Y
L2205 D2205

Komb. 4
2xSN304M
1xSN204M
2xSN104Y
L 3025 D 2895

Komb. 5
1xSN204M
1xSN104I
1xSN104M
1xSN104Y
1xSN304M
L4270 D2320

Komb. 6
4xSN104M
4xSN104Y
L2330 D2330

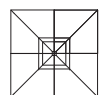

Komb. 7
4xSN104Y
L1635 D1635

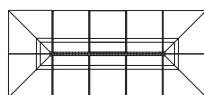

Komb. 8
4xSN104Y
3xSN304M
L 3715 D1635

Tillbehör Accessories	Artno	Mått Dimension mm	Priser Prices see page 102
	SNASV	L 750 D 60 W 430/190	Armstöd. Vänster. Armrest. Left.
	SNASH	L 750 D 60 W 430/190	Armstöd. Höger. Armrest. Right.
	SNASM	L 508 D 60 H190	Armstöd. Mellan. Placeras mellan sittdynor. Armrest. Middle. Placed between seating.
	SNPUB	ø 260	Pop-up bord Massiv trä, klarlack. Pop-up table. Solid wood, clear lacquer
	SNKBS		Kopplingsbeslag mellan soffor. Svart metall. Link fittings between sofas. Black metal.
	TKB11	Ø 57	Powerdot Mini. 1 eluttag, svart, 1,5m kabel. Monteras i sargen framtill nära ben. Gäller för SE,NO,FIN,DE,NL. Powerdot Mini. 1 electrical black, 1,5m cable. Electrical outlets can be fitted to the front of the rail close to leg. For SE,NO,FIN,DE,NL.
	TKB19	Ø 57	Powerdot Mini. USB C laddare inkl. 2 portar, svart, 1,25m kabel. Gäller för SE,NO,FIN,DE,NL. Powerdot Mini. USB C charging incl. 2 ports, black, 1,25m cable. For SE,NO,FIN,DE,NL.

Artno	Längd Length mm	Djup Depth mm	Höjd Height mm	Sithöjd Seat height mm	Soigné SEK	Extra SEK							Tygätgång på 140 cm bredd till sitt- och ryggplymä Requirement of fabric width 140 cm for seat and back cushion	Vikt netto Weight net kilos	Volym Volume net
					.10 ek oak .30 ask ash	Standardbets på ask Standard stain on ash Vitpigment ek ask White glazed oak ash	Tyg Fabric Prisgrupp Pricegroup 1	Tyg Fabric Prisgrupp Pricegroup 2	Tyg Fabric Prisgrupp Pricegroup 3	Tyg Fabric Prisgrupp Pricegroup 4	Standard läder Leather				
Fätölj/Soffa inkl. armstöd Easy chair/Sofa incl. armrest															
SN104MA	760	815	780	430	20300	+1570	+5490	+6950	+8420	+9880	+8360	390 cm	32	0,45	
SN107MA	760	815	840	490	20300	+1570	+5490	+6950	+8420	+9880	+8360	390 cm	33	0,48	
SN204MA	1450	815	780	430	29920	+2530	+8120	+10370	+12620	+14870	+12930	600 cm	55	0,89	
SN207MA	1450	815	840	490	29920	+2530	+8120	+10370	+12620	+14870	+12930	600 cm	55	0,96	
SN304MA	2150	815	780	430	40680	+3610	+10870	+13940	+17020	+20090	+17490	820 cm	70	1,33	
SN307MA	2150	815	840	490	40680	+3610	+10870	+13940	+17020	+20090	+17490	820 cm	70	1,43	
Sektion fätölj/soffa Section easy chair/sofa															
SN104M	700	815	780	430	15680	+1570	+3300	+4110	+4920	+5720	+4940	215 cm	26	0,45	
SN107M	700	815	840	490	15680	+1570	+3300	+4110	+4920	+5720	+4940	215 cm	27	0,48	
SN204M	1390	815	780	430	25300	+2530	+5990	+7600	+9220	+10830	+9510	430 cm	48	0,89	
SN207M	1390	815	840	490	25300	+2530	+5990	+7600	+9220	+10830	+9510	430 cm	48	0,96	
SN304M	2080	815	780	430	36060	+3610	+8740	+11180	+13620	+16050	+14070	650 cm	70	1,33	
SN307M	2080	815	840	490	36060	+3610	+8740	+11180	+13620	+16050	+14070	650 cm	70	1,43	
Hörn Corner															
SN104I	810	815	780	430	23700	+2370	+5990	+7600	+9220	+10830	+10620	430 cm	34	0,51	
SN107I	810	815	840	490	23700	+2370	+5990	+7600	+9220	+10830	+10620	430 cm	34	0,55	
SN104Y	820	820	780	430	17640	+1760	+4370	+5490	+6620	+7740	+8270	300 cm	23	0,52	
SN107Y	820	820	840	490	17640	+1760	+4370	+5490	+6620	+7740	+8270	300 cm	23	0,56	
Tillbehör Accessories															
SNASV armstöd armrest left	750	60	430/190		2310 tyg fabric	----	+1680	+2000	+2320	+2640	+1710	85 cm	4		
SNASH armstöd armrest right	750	60	430/190		2310 tyg fabric	----	+1680	+2000	+2320	+2640	+1710	85 cm	4		
SNASM armstöd armrest middle	508	60	190		2220 tyg fabric	----	+1680	+2000	+2320	+2640	+1110	85 cm	3		
SNPUB pop-up bord table	ø260	---	---		2830 trä wood	+280	----	----	----	----	----		2		
SNKBS koppl.beslag fittings					750 svart black	----	----	----	----	----	----		1		
TKB11 elecctrical	ø57				840 svart/black	----									
TKB19 electrical	ø57				1380 svart/black										

Soffa.

Stoppning kallsaum. Klädd rygg med klädda knappar och klädd sits, exkl tyg/läder.
 Stoppning kallsaum.
 Ben i massiv trä. Ytbehandling klarlack. Sofan levereras monterad.
 Vid beställning ange artikelnummer, utförande och klädsel.

Sofa.

Padding polyether. Upholstered back incl. bottom and and upholstered seat excl. fabric/leather.
 Legs in solid wood. Finish clear lacquer. The sofa comes pre-assembled.
 When ordering article number, execution and name of fabric/leather.

Artno

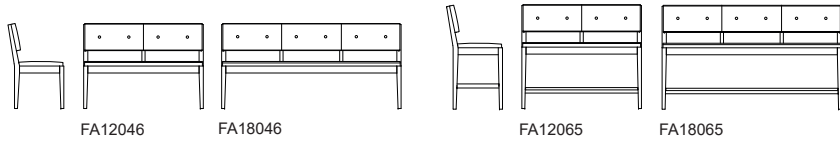

Soffa Sofa FA12065 Pop-up bord table FAPUB | Hylla Shelf CUBE BRICK | Pall Stool SHELL | Bord Table LOLLIPOP

Tillbehör Accessories	Artno	Mått Dimension mm	
	FAASV	B/W 41	Armstöd. Vänsterställd. Massiv trä, klarlack. Armrest. Left hung. Solid wood.
	FAASH	B/W 41	Armstöd. Högerställd. Massiv trä, klarlack. Armrest. Right hung. Solid wood, clear lacquer
	FAPUB	ø290	Pop-up bord inkl. 1st krok. Massiv trä, klarlack. Placerad enligt önskemål. Beslag blankkrom. Pop-up table incl. 1pc hook. Solid wood, clear lacquer. Placed upon request. Fitting polished chrome
	FAKB1	L275 B/W450	Kopplingsbord, rak. Fanerad trälamell, klarlack. Linking table, straight. Veneered blockboard, clear lacquer.
	FAKB2	450x450	Kopplingsbord hörn. Fanerad trälamell, klarlack. Linking table, corner. Veneered blockboard, clear lacquer.
	FAKB2S	450x450 skål bowl ø250	Kopplingsbord hörn. Fanerad trälamell, klarlack. Inkl. planteringskäril svart ABS plast. Linking table, corner. Veneered blockboard, clear lacquer. Incl. planting bowl black ABS plastic.
	FAKBS		Kopplingsbeslag mellan soffor. Svart metall. Link fittings between sofas. Black metal.

Artno	Längd Length mm	Djup Depth mm	Höjd Height mm	Sithöjd Seat height mm	Facile SEK	Extra SEK							Tygåtgång på 140 cm bredd Requirement of fabric width 140 cm	Vikt netto Weight net kilos	Volym Volume net
					.10 ek oak .30 ask ash	Standardbets på ask Standard stain on ash Vitpigment ek ask White glazed oak ash	Tyg Fabric Prisgrupp Pricegroup 1	Tyg Fabric Prisgrupp Pricegroup 2	Tyg Fabric Prisgrupp Pricegroup 3	Tyg Fabric Prisgrupp Pricegroup 4	Standard läder Leather				
FA12046	1200	560	852	460	21250	+3200	+2370	+2890	+3420	+3940	+5830	140 cm	22	1,06	
FA18046	1800	560	852	460	25680	+3850	+3120	+3870	+4620	+5370	+7990	200 cm	31	1,68	
FA12065	1200	560	1042	650	23800	+3570	+2370	+2890	+3420	+3940	+5830	140 cm	28	1,26	
FA18065	1800	560	1042	650	28630	+4280	+3120	+3870	+4620	+5370	+7990	200 cm	36	2,0	

Artno	Längd Length mm	Bredd Width mm	Diam mm	Tillbehör Accessories SEK	Extra SEK	
				.10 ek oak .30 ask ash	Standardbets på ask Standard stain on ash Vitpigment ek ask White glazed oak ash	Vikt netto Weight net kilos
FAASV Armstöd vänster Armrest left		41		1090	+180	0,5
FAASH Armstöd höger Armrest right		41		1090	+180	0,5
FAPUB Pop-up bord table			290	2690	+420	2
FAKB1 Koppl.bord rak Linking table straight	275	450		2240	+340	3
FAKB2 Koppl.bord hörn Linking table corner	450	450		3520	+530	8
FAKB2S Koppl.bord hörn inkl. planteringskäril Linking table corner incl. planting bowl	450	450	250 skål bowl	4250	+530	9
FAKBS Koppl.beslag, svart Link fittings, black				430 svart black metal		

KAMÓN DINNER

Moni Beuchel 2017

Möbelfakta

Soffa.

Klädd rygg och sits exkl. tyg/läder. Stoppling kallskum.
Ben i massiv trä. Ytbehandling klarlack. Sofan levereras monterad.
Vid beställning ange artikelnummer, utförande och klädsel.

Sofa.

Upholstered back and seat excl. fabric/leather. Padding in cold-cured foam.
Legs in solid wood. Finish clear lacquer. The sofa comes pre-assembled.
When ordering article number, execution and name of fabric/leather.

Artno

Rak soffa / Straight sofa



382

383

384

Innerhorn / Inner corner



Höger / Right
382IH
383IH
384IH

Vänster / Left
382IV
383IV
384IV

Ytterhorn / Outer corner

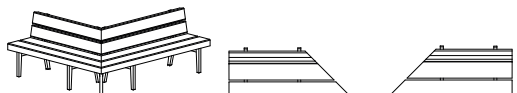

Höger / Right
382YH
383YH
384YH

Vänster / Left
382YV
383YV
384YV



Tillbehör Accessories	Artno	Mått Dimension mm	
	381AS1.3	L435 W100 H160 H645 från golv from floor	Armstöd klädd. Placerad enligt önskemål, ej över ben. Beslag svart metall. Armrest upholstered. Placed upon request, not over leg. Fitting black metal.
	381AS2.3	L435 W100 H160 H645 från golv from floor	Armstöd klädd. Placerad över ben. Beslag svart metall. Armrest upholstered. Placed over leg. Fitting black metal.
	381PB1	L494 ø280 H655 från golv from floor	Pop-up bord. Massiv trä, klarlack. Placerad enligt önskemål, ej över ben. Beslag svart metall. Pop-up table. Solid wood, clear lacquer. Placed upon request, not over leg. Fitting black metal.
	381PB2	L494 ø280 H655 från golv from floor	Pop-up bord. Massiv trä, klarlack. Placerad över ben. Beslag svart metall. Pop-up table. Solid wood, clear lacquer. Placed over leg. Fitting black metal.
	381KB1	450x450	Kopplingsbord rak. Linking table, straight.
	381KB2	450x450	Kopplingsbord hörn. Linking table, corner.
	381.EL.1		1 eluttag inkl. 2meter kabel. Placeras nära benen i framkant under sits. 1 electrical outlets incl. 2meters cable. Placed close to legs in front under seat.
	381.KB		Kopplingsbeslag. Svart metall. Link fittings. Black metal.

Artno	Kamón Dinner SEK						Extra SEK									Tygätgång på 140 cm bredd Requirement of fabric width 140 cm	Vikt netto Weight net kilos	Volym Volume net
	Längd Length mm	Djup Depth mm	Höjd Height mm	Sitthöjd Seat height mm	.10 ek oak .20 björk birch .30 ask ash	.50 Lack Color	Standardbets på ask Standard stain on ash Vitpigment ek ask White glazed oak ash	Tyg Fabric Prisgrupp Pricegroup 1	Tyg Fabric Prisgrupp Pricegroup 2	Tyg Fabric Prisgrupp Pricegroup 3	Tyg Fabric Prisgrupp Pricegroup 4	Standard läder Leather						
Soffa rak Sofa straight																		
382	1300	656	818	460	18830	21620	+2820	+4620	+5820	+7020	+8220	+7790	320 cm	32	0,8			
383	1950	656	818	460	25110	28850	+3790	+6240	+7930	+9620	+11300	+11380	450 cm	47	1,2			
384	2600	656	818	460	30340	34880	+4530	+7870	+10040	+12220	+14390	+15160	580 cm	56	1,6			
Hörn Corner																		
382IH	1300	656	818	460	24280	27090	+2820	+4620	+5820	+7020	+8220	+7790	320 cm	32	0,8			
382IV	1300	656	818	460	24280	27090	+2820	+4620	+5820	+7020	+8220	+7790	320 cm	32	0,8			
382YH	1300	656	818	460	24770	27570	+2820	+4620	+5820	+7020	+8220	+7790	320 cm	32	0,8			
382YV	1300	656	818	460	24770	27570	+2820	+4620	+5820	+7020	+8220	+7790	320 cm	32	0,8			
383IH	1950	656	818	460	30580	34340	+3790	+6240	+7930	+9620	+11300	+11380	450 cm	47	1,2			
383IV	1950	656	818	460	30580	34340	+3790	+6240	+7930	+9620	+11300	+11380	450 cm	47	1,2			
383YH	1950	656	818	460	31060	34820	+3790	+6240	+7930	+9620	+11300	+11380	450 cm	47	1,2			
383YV	1950	656	818	460	31060	34820	+3790	+6240	+7930	+9620	+11300	+11380	450 cm	47	1,2			
384IH	2600	656	818	460	35840	40350	+4530	+7870	+10040	+12220	+14390	+15160	580 cm	56	1,6			
384IV	2600	656	818	460	35840	40350	+4530	+7870	+10040	+12220	+14390	+15160	580 cm	56	1,6			
384YH	2600	656	818	460	36300	40840	+4530	+7870	+10040	+12220	+14390	+15160	580 cm	56	1,6			
384YV	2600	656	818	460	36300	40840	+4530	+7870	+10040	+12220	+14390	+15160	580 cm	56	1,6			

Artno	Tillbehör Accessories SEK						Extra SEK									Tygätgång på 140 cm bredd Requirement of fabric width 140 cm	Vikt netto Weight net kilos
	Längd Length mm	Bredd Width mm	Diam mm	Höjd Height mm	Klädd exkl tyg/läder Upholstred excl fabric/leather	.10 ek oak .20 björk birch .30 ask ash	.50 Lack Color	Standardbets på ask Standard stain on ash Vitpigment ek ask White glazed oak ash	Tyg Fabric Prisgrupp Pricegroup 1	Tyg Fabric Prisgrupp Pricegroup 2	Tyg Fabric Prisgrupp Pricegroup 3	Tyg Fabric Prisgrupp Pricegroup 4	Standard läder Leather				
381AS1.3 Armstöd Armrest	435	100		160 645 from golv floor	2940				+1180	+1350	+1520	+1690	+1210	45 cm	1		
381AS2.3 Armstöd Armrest	435	100		160 645 from golv floor	2940				+1180	+1350	+1520	+1690	+1210	45 cm	1		
381PB1 Pop-up bord table	494		280	655 from golv floor		4070	4690	+610							2		
381PB2 Pop-up bord table	494		280	655 from golv floor		4070	4690	+610							2		
381KB1 Koppl.bord rak Linking table straight	450	450				3700	4260	+550							3		
381KB2 Koppl.bord hörn Linking table corner	450	450				5190	5980	+790							8		
381EL1 Eluttag Electrical outlet						2110	2110	+170							1		
381.KB Koppl.beslag svart Link fittings black							360 svart black								1		

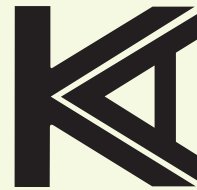

KARL ANDERSSON & SÖNER

Handmade in Huskvarna. Since 1898.

Karl Andersson & Söner Rosendalagatan 6, SE-561 34 Huskvarna, Sweden.
+46(0)36-13 25 30. info@karl-andersson.se

Showrooms

Studio B3

Barnhusgatan 3, Stockholm. +46 (0)8 21 42 31

Studio L6

Lasarettsgatan 6, Göteborg. +46 (0)31 13 83 90

Studio Skøi / BOA / Skar Studio

Drammensvei 130. Entrance A3. Etage 1, Oslo. +47 901 31 384

Interior / Nordic Design Lab

66 rue d'Hauteville, 75010 Paris. +33 (0)6 6682 8966 (by appointment)

karl-andersson.se